

MODEL:

PPC-F12B/15B/17B/19B-BTi

**Industrial Panel PC with Intel® Celeron® Processor J1900,
Touchscreen, Dual PCIe Mini, USB 3.0, HDMI
SATA 6Gb/s, Dual PCIe GbE, iRIS-2400,
IP 65 Compliant Front Panel and RoHS Compliant**

User Manual

Revision

Date	Version	Changes
December 26, 2016	1.05	Added PPC-F19B-BTi model information
August 8, 2016	1.04	Added Section 3.10: Wireless LAN Module Installation (Optional)
June 23, 2016	1.03	Added Section 3.17: OS Installation Updated Chapter 4: BIOS Setup
May 18, 2016	1.02	Updated Section 3.6: SO-DIMM Installation Updated Section 3.11: AT/ATX Mode Selection Updated Section 3.14: Powering On the System Updated Section 5.4.2: South Bridge
July 31, 2015	1.01	Modified Section 1.2: Model Variation Modified Section 1.6: Bottom Panel
May 26, 2015	1.00	Initial release



Safety Instructions

- en** Warning! Read the user manual before connecting the system to the power source.
- de** Vorsicht! Bitte lesen Sie die Bedienungsanleitung, bevor Sie das System an eine Stromquelle anschließen.
- fr** Attention! Avant de brancher le système à la source d'alimentation, consultez le mode d'emploi.
- it** Avvertenza! Consultare il manuale utente prima di collegare il sistema all'alimentatore.
- es** Atención! Lea atentamente este manual del usuario antes de operar la fuente de alimentación.
- zh** 警告！在將系統連接到電源之前，請仔細閱讀使用手冊。
- cn** 警告！在將系統連接到電源之前，請仔細閱讀使用手冊。
-

- en** Warning! To prevent the system from overheating, do not operate it in an area that exceeds the maximum operating temperature described in the user manual.
- de** Vorsicht! Um eine Überhitzung des Systems zu vermeiden, betreiben Sie es ausschließlich im zulässigen Betriebstemperaturbereich. Dieser ist in der Bedienungsanleitung vermerkt.
- fr** Attention! Pour éviter la surchauffe du système, ne l'utilisez pas dans une zone dont la température dépasse les limites décrits dans le mode d'emploi.
- it** Avvertenza! Per evitare che il sistema si surriscaldi, non utilizzarlo in aree che superino la temperatura massima d'esercizio descritta nel manuale utente.
- es** Atención! Para evitar el excesivo calentamiento del sistema, no opere en las condiciones de temperatura superior a lo recomendado en este manual del usuario.
- zh** 警告！為防止系統過熱，不要在超過使用手冊上記載的產品工作溫度範圍之外操作此系統。
- cn** 警告！為防止系統過熱，不要在超過使用手冊上記載的產品工作溫度範圍之外操作此系統。
-

- en** Warning! Use only the adapter and power cord approved for this system. Use of another type of adapter may risk fire or explosion. Please refer to the user manual for the power adapter specifications.
- de** Vorsicht! Nur zugelassene Netzteile und Netzkabel dürfen verwendet werden. Die Benutzung von anderen Netzteilen kann einen Brand oder eine Explosion zur Folge haben. Prüfen Sie die jeweiligen Spezifikationen in der Bedienungsanleitung.
- fr** Attention! Utilisez exclusivement le câble d'alimentation et l'adaptateur homologués pour ce système. L'utilisation d'un autre type d'adaptateur risquerait de provoquer un incendie ou une explosion. Veuillez référer au mode d'emploi pour les spécifications de l'adaptateur d'alimentation.
- it** Avvertenza! Utilizzare solo l'adattatore e il cavo di alimentazione approvati per questo sistema. L'uso di un altro tipo di adattatore può causare rischio d'incendio o esplosione. Si prega di fare riferimento al manuale utente per le specifiche sull'alimentazione.
- es** Atención! Utilice solamente el adaptador de corriente alterna (CA) con Marcas Conformidad otorgadas. Cualquier otro adaptador no otorgado aumenta el riesgo de explosión o incendio. Por favor consulte el manual del usuario para las especificaciones del adaptador de alimentación.
- zh** 警告！只能使用經過認證、適用於本系統的電源變壓器與電源線。使用不適用的電源變壓器將可能導致火災或爆炸。電源變壓器規格請參考使用手冊。
- cn** 警告！只能使用经过认证，适用于本系统的电源适配器与电源线。使用不适用的电源适配器将可能导致火灾或爆炸。电源适配器规格请参考使用手冊。

-
- en** Warning! Ultimate disposal of this product should be handled according to all national laws and regulations.
- de** Vorsicht! Die Entsorgung dieses Produkts sollte gemäß allen Bestimmungen und Gesetzen des Landes erfolgen.
- fr** Attention! La mise au rebut ou le recyclage de ce produit sont généralement soumis aux lois et/ou directives de respect de l'environnement. Renseignez-vous auprès de l'organisme compétent.
- it** Avvertenza! Lo smaltimento di questo prodotto deve essere eseguito secondo le leggi e i regolamenti locali.
- es** Atención! La disposición final de residuos de este producto se debe cumplir con las normativas y leyes del país.
- zh** 警告！本產品的廢棄處理應根據該國家的法律和規章進行。
- cn** 警告！本产品的废弃处理应根据该国家的法律和规章进行。
-

Copyright

COPYRIGHT NOTICE

The information in this document is subject to change without prior notice in order to improve reliability, design and function and does not represent a commitment on the part of the manufacturer.

In no event will the manufacturer be liable for direct, indirect, special, incidental, or consequential damages arising out of the use or inability to use the product or documentation, even if advised of the possibility of such damages.

This document contains proprietary information protected by copyright. All rights are reserved. No part of this manual may be reproduced by any mechanical, electronic, or other means in any form without prior written permission of the manufacturer.

TRADEMARKS

All registered trademarks and product names mentioned herein are used for identification purposes only and may be trademarks and/or registered trademarks of their respective owners.

Manual Conventions



WARNING

Warnings appear where overlooked details may cause damage to the equipment or result in personal injury. Warnings should be taken seriously.



CAUTION

Cautionary messages should be heeded to help reduce the chance of losing data or damaging the product.



NOTE

These messages inform the reader of essential but non-critical information. These messages should be read carefully as any directions or instructions contained therein can help avoid making mistakes.



HOT SURFACE

This symbol indicates a hot surface that should not be touched without taking care.

Table of Contents

1 INTRODUCTION.....	1
1.1 OVERVIEW.....	2
1.2 MODEL VARIATION.....	3
1.3 FEATURES.....	3
1.4 FRONT PANEL.....	4
1.5 REAR PANEL.....	4
1.6 BOTTOM PANEL.....	5
1.7 DIMENSIONS.....	7
1.7.1 PPC-F12B-BTi Dimensions.....	7
1.7.2 PPC-F15B-BTi Dimensions.....	8
1.7.3 PPC-F17B-BTi Dimensions.....	9
1.7.4 PPC-F19B-BTi Dimensions.....	10
1.8 SPECIFICATIONS	11
2 UNPACKING	13
2.1 UNPACKING.....	14
2.2 PACKING LIST.....	15
2.3 OPTIONAL ITEMS.....	16
3 INSTALLATION	17
3.1 ANTI-STATIC PRECAUTIONS	18
3.2 INSTALLATION PRECAUTIONS	18
3.3 PREINSTALLED COMPONENTS.....	19
3.4 INSTALLATION AND CONFIGURATION STEPS	19
3.5 REMOVING THE BACK COVER	20
3.6 SO-DIMM INSTALLATION	20
3.7 HDD INSTALLATION.....	22
3.8 mSATA MODULE INSTALLATION	24
3.9 IRIS-2400 MODULE INSTALLATION.....	27
3.10 WIRELESS LAN MODULE INSTALLATION (OPTIONAL).....	29
3.11 AT/ATX MODE SELECTION	33

3.12 MOUNTING THE SYSTEM	34
3.12.1 Wall Mounting.....	34
3.12.2 Panel Mounting.....	37
3.12.3 Rack and Cabinet Installation	41
3.12.3.1 Rack Mounting for F12B, F15B and F17B	42
3.12.3.2 Rack Mounting for F19B	44
3.12.4 Arm Mounting	47
3.12.5 Stand Mounting	49
3.13 SERIAL DEVICE CONNECTION	51
3.13.1 RS-232 Serial Ports (COM1, COM2).....	51
3.13.2 RS-232/422/485 Serial Port (COM3)	52
3.14 POWERING ON THE SYSTEM.....	52
3.15 RESET THE SYSTEM	53
3.16 CLEAR CMOS.....	54
3.17 OS INSTALLATION	54
3.18 DRIVER INSTALLATION.....	55
3.18.1 Keypad AP.....	56
3.19 IPMI SETUP PROCEDURE	56
3.19.1 Managed System Hardware Setup	56
3.19.2 Using the IEI iMAN Web GUI.....	57
4 SYSTEM MAINTENANCE	59
4.1 SYSTEM MAINTENANCE INTRODUCTION	60
4.2 MOTHERBOARD REPLACEMENT	60
5 BIOS SETUP	61
5.1 INTRODUCTION.....	62
5.1.1 Starting Setup.....	62
5.1.2 Using Setup	62
5.1.3 Getting Help.....	63
5.1.4 Unable to Reboot after Configuration Changes	63
5.1.5 BIOS Menu Bar.....	63
5.2 MAIN.....	64
5.3 ADVANCED.....	65
5.3.1 F81866 Super IO Configuration	66

PPC-F12B/15B/17B/19B-BTi Panel PC

5.3.1.1 Serial Port n Configuration	67
5.3.2 iWDD H/W Monitor	70
5.3.3 RTC Wake Settings	71
5.3.4 Serial Port Console Redirection	72
5.3.4.1 Console Redirection Settings	73
5.3.5 iEi Feature	76
5.3.6 CPU Configuration	77
5.3.7 IDE Configuration	79
5.3.8 USB Configuration	80
5.4 CHIPSET	81
5.4.1 North Bridge	82
5.4.1.1 Intel IGD Configuration	82
5.4.2 South Bridge	84
5.4.2.1 PCI Express Configuration	86
5.5 SECURITY	87
5.6 BOOT	88
5.7 SAVE & EXIT	90
5.8 SERVER MGMT	92
5.8.1 System Event Log	93
5.8.2 BMC Network Configuration	94
6 INTERFACE CONNECTORS	96
6.1 PERIPHERAL INTERFACE CONNECTORS	97
6.2 INTERNAL PERIPHERAL CONNECTORS	98
6.2.1 Audio Connector (AUDIO1)	100
6.2.2 Chassis Intrusion Connector (CHASSIS1)	100
6.2.3 Debug Port (DBG_PORT1)	100
6.2.4 DIO Connector (DIO1)	101
6.2.5 EC Debug Port (CN2)	101
6.2.6 Fan Connector (CPU_FAN1)	102
6.2.7 Front Panel Connector (F_PANEL1)	102
6.2.8 I ² C Connector (I2C1)	102
6.2.9 IPMI Active LED Connector (LEDCN1)	103
6.2.10 Keyboard and Mouse Connector (KB_MS1)	103
6.2.11 Keypad Connector (OSD1)	103

6.2.12 LAN Active LED Connectors (LAN_LED1).....	104
6.2.13 LVDS Connector (LVDS1).....	104
6.2.14 LVDS Backlight Connector (INVERTER1).....	105
6.2.15 PCIe Mini (MINI_PCIE1) and mSATA (M_SATA1) Card Slots.....	105
6.2.16 Power Button Connector (PWR_BTN1)	106
6.2.17 Power Source Connector (PWR1)	106
6.2.18 Reset Button Connector (RST_BTN2).....	106
6.2.19 Resistive Touchscreen Connector (TOUCH1)	107
6.2.20 RS-232 Connector (COM4, COM5)	107
6.2.21 SATA 6Gb/s Connectors (SATA1, SATA2).....	108
6.2.22 SATA Power Connectors (SATA_PWR1, SATA_PWR2).....	108
6.2.23 SMBus Connector (SMB1).....	108
6.2.24 SPI Flash Connector (JSPI1).....	109
6.2.25 SPI Flash (EC) Connector (JSPI2).....	109
6.2.26 U3 Firmware Programming Connector (JP2).....	109
6.2.27 USB 2.0 Connector (USB1)	110
6.3 EXTERNAL INTERFACE PANEL CONNECTORS	110
6.3.1 HDMI Connector (HDMI1).....	111
6.3.2 GbE Connectors (LAN1, LAN2)	111
6.3.3 RS-232 Serial Ports (COM1, COM2).....	111
6.3.4 RS-232/422/485 Serial Port (COM3)	112
6.3.5 USB 2.0 Connectors (USB_CON1).....	112
6.3.6 USB 3.0 Connectors (USB3_CON1).....	112
6.3.7 VGA Connector (VGA1).....	113
6.4 PRECONFIGURED JUMPERS	113
6.4.1 Backlight Voltage Selection Jumper (JP1).....	114
6.4.2 LVDS Panel Resolution Selection Switch (SW1)	114
6.4.3 Panel Voltage Selection Jumper (JLCD_PWR1).....	115
A REGULATORY COMPLIANCE	116
B BIOS CONFIGURATION OPTIONS.....	121
B.1 BIOS CONFIGURATION OPTIONS	122
C SAFETY PRECAUTIONS.....	124
C.1 SAFETY PRECAUTIONS.....	125

PPC-F12B/15B/17B/19B-BTi Panel PC

<i>C.1.1 General Safety Precautions</i>	125
<i>C.1.2 Anti-static Precautions</i>	126
<i>C.1.3 Product Disposal</i>	127
C.2 MAINTENANCE AND CLEANING PRECAUTIONS	128
<i>C.2.1 Maintenance and Cleaning</i>	128
<i>C.2.2 Cleaning Tools</i>	128
D WATCHDOG TIMER	130
E HAZARDOUS MATERIALS DISCLOSURE	133

List of Figures

Figure 1-1: PPC-F12B/15B/17B/19B-BTi Series Panel PC	2
Figure 1-2: Front View	4
Figure 1-3: PPC-F17B-BTi Rear View.....	4
Figure 1-4: PPC-F12B-BTi Bottom View	5
Figure 1-5: PPC-F15B/F17B-BTi Bottom View	5
Figure 1-6: PPC-F19B-BTi Bottom View	6
Figure 1-7: PPC-F12B-BTi Dimensions (mm)	7
Figure 1-8: PPC-F15B-BTi Dimensions (mm)	8
Figure 1-9: PPC-F17B-BTi Dimensions (mm)	9
Figure 1-10: PPC-F19B-BTi Dimensions (mm)	10
Figure 3-1: PPC-F17B-BTi Back Cover Retention Screws	20
Figure 3-2: SO-DIMM Slot Location	21
Figure 3-3: SO-DIMM Heatspreader Installation	21
Figure 3-4: SO-DIMM Installation	22
Figure 3-5: PPC-F17B-BTi HDD Bracket Retention Screws	23
Figure 3-6: HDD Retention Screws	23
Figure 3-7: PPC-F17B-BTi HDD Installation.....	24
Figure 3-8: PCIe Mini Card Slot which supports mSATA	25
Figure 3-9: Removing the Retention Screws	25
Figure 3-10: Inserting the PCIe Mini Card into the Slot at an Angle.....	26
Figure 3-11: Securing the PCIe Mini Card	26
Figure 3-12: Motherboard Retention Screws.....	27
Figure 3-13: iRIS-2400 Module Slot Location	28
Figure 3-14: iRIS-2400 Module Installation	28
Figure 3-15: Knockouts on Top Panel for Wireless Antennas.....	29
Figure 3-16: PCIe Mini Slot Location	30
Figure 3-17: Inserting the WLAN Module	30
Figure 3-18: Securing WLAN Module	31
Figure 3-19: Connecting RF Cables.....	31
Figure 3-20: Securing SMA Connector and External Antenna Installation	32
Figure 3-21: AT/ATX Mode Selection.....	33

PPC-F12B/15B/17B/19B-BTi Panel PC

Figure 3-22: Wall-mounting Bracket	35
Figure 3-23: Mount the Chassis	36
Figure 3-24: Secure the Chassis	37
Figure 3-25: PPC-F17B-BTi Mounting Bracket Installation	38
Figure 3-26: PPC-F12B-BTi Panel Cutout Dimensions	39
Figure 3-27: PPC-F15B-BTi Panel Cutout Dimensions	39
Figure 3-28: PPC-F17B-BTi Panel Cutout Dimensions	39
Figure 3-29: PPC-F19B-BTi Panel Cutout Dimensions	40
Figure 3-30: Tighten the Mounting Clamp Screws	41
Figure 3-31: PPC-F17B-BTi Mounting Bracket Installation	42
Figure 3-32: The Rack/Cabinet Bracket.....	42
Figure 3-33: Secure the Rack/Cabinet Bracket.....	43
Figure 3-34: Install into a Rack/Cabinet	44
Figure 3-35: PPC-F19B-BTi Mounting Bracket Installation	44
Figure 3-36: Slide through the Rack/Cabinet Bracket	45
Figure 3-36: PPC-F19B-BTi Side Bracket Installation.....	45
Figure 3-37: Secure the Rack/Cabinet Bracket.....	46
Figure 3-38: Install into a Rack/Cabinet	47
Figure 3-39: Arm Mounting Retention Screw Holes.....	48
Figure 3-40: Arm Mounting (ARM-11-RS).....	49
Figure 3-41: Stand Mounting Retention Screw Holes.....	50
Figure 3-42: Stand Mounting (Stand-Axx).....	50
Figure 3-43: Serial Port Locations	51
Figure 3-44: Power Input Connector Pinouts	52
Figure 3-45: Power Connectors and Power Switch	53
Figure 3-46: Reset Button Location.....	53
Figure 3-47: Clear CMOS Button Location.....	54
Figure 3-48: BIOS Option–OS Selection	54
Figure 3-49: Keypad AP	56
Figure 3-50: IEI iMAN Web Address.....	57
Figure 3-51: IEI iMAN Web GUI.....	58
Figure 6-1: Main Board Layout Diagram (Front Side).....	97
Figure 6-2: Main Board Layout Diagram (Solder Side).....	98

List of Tables

Table 1-1: Model Variation	3
Table 1-2: System Specifications.....	12
Table 2-1: Packing List.....	16
Table 2-2: Optional Items	16
Table 3-1: RS-232 Serial Port (COM1, COM2) Pinouts	51
Table 3-2: RS-232/422/485 Serial Port (COM3) Pinouts	52
Table 5-1: BIOS Navigation Keys	63
Table 6-1: Peripheral Interface Connectors	99
Table 6-2: Audio Connector (AUDIO1) Pinouts	100
Table 6-3: Chassis Intrusion Connector (CHASSIS1) Pinouts.....	100
Table 6-4: Debug Port (DBG_PORT1) Pinouts.....	100
Table 6-5: DIO Connector (DIO1) Pinouts	101
Table 6-6: EC Debug Port (CN2) Pinouts.....	101
Table 6-7: Fan Connector (CPU_FAN1) Pinouts.....	102
Table 6-8: Front Panel Connector (F_PANEL1) Pinouts.....	102
Table 6-9: I ² C Connector (I2C1) Pinouts.....	102
Table 6-10: IPMI Active LED Connector (LEDCN1) Pinouts	103
Table 6-11: Keyboard and Mouse Connector (KB_MS1) Pinouts.....	103
Table 6-12: Keypad Connector (OSD1) Pinouts	103
Table 6-13: LAN Active LED Connectors (LAN_LED1) Pinouts	104
Table 6-14: LVDS Connector (LVDS1) Pinouts.....	104
Table 6-15: LVDS Backlight Connector (INVERTER1) Pinouts.....	105
Table 6-16: PCIe Mini (MINI_PCIE1) and mSATA (M_SATA1) Card Pinouts.....	106
Table 6-17: Power Button Connector (PWR_BTN1) Pinouts.....	106
Table 6-18: Power Source Connector (PWR1) Pinouts.....	106
Table 6-19: Reset Button Connector (RST_BTN2) Pinouts.....	106
Table 6-20: Resistive Touchscreen Connector (TOUCH1) Pinouts.....	107
Table 6-21: RS-232 Connector (COM4, COM5) Pinouts	107
Table 6-22: SATA 6Gb/s Connectors (SATA1, SATA2) Pinouts	108
Table 6-23: SATA Power Connectors (SATA_PWR1, SATA_PWR2) Pinouts.....	108
Table 6-24: SMBus Connector (SMB1) Pinouts.....	108

PPC-F12B/15B/17B/19B-BTi Panel PC

Table 6-25: SPI Flash Connector (JSPI1) Pinouts	109
Table 6-26: SPI Flash (EC) Connector (JSPI2) Pinouts.....	109
Table 6-27: U3 Firmware Programming Connector (JP2) Pinouts	110
Table 6-28: USB 2.0 Connector (USB1) Pinouts.....	110
Table 6-29: Rear Panel Connectors	110
Table 6-30: HDMI Connector (HDMI1) Pinouts.....	111
Table 6-31: RJ-45 GbE Connector (LAN1, LAN2) Pinouts	111
Table 6-32: RS-232 Serial Port (COM1, COM2) Pinouts	111
Table 6-33: RS-232/422/485 Serial Port (COM3) Pinouts	112
Table 6-34: USB 2.0 Connector (USB_CON1) Pinouts.....	112
Table 6-35: USB 3.0 Connector (USB3_CON1) Pinouts.....	113
Table 6-36: VGA Connector (VGA1) Pinouts	113
Table 6-37: Preconfigured Jumpers	113
Table 6-38: Panel Voltage Selection Jumper (JP1) Settings.....	114
Table 6-39: LVDS Panel Resolution Selection.....	114
Table 6-40: Panel Voltage Selection Jumper (JLCD_PWR1) Settings	115

Chapter

1

Introduction

1.1 Overview



Figure 1-1: PPC-F12B/15B/17B/19B-BTi Series Panel PC

The PPC-F12B/15B/17B/19B-BTi series is a quad-core Intel® Celeron® processor J1900 powered flat bezel panel PC with a rich variety of functions and peripherals. The rugged and trendy design can be applied in harsh industrial environments and enriches aesthetic experience at the same time.

The Intel® Celeron® processor J1900 is a SoC (System-on-Chip) that ensures optimal memory, graphics, and peripheral I/O support. The system equips with SATA 6Gb/s interface, supporting both SATA HDD and SSD. In addition, the PPC-F12B/15B/17B/19B-BTi features Intelligent Platform Management Interface 2.0 (IPMI 2.0) that helps lower the overall costs of server management by enabling users to maximize IT resource, save time and manage multiple systems. The PPC-F12B/15B/17B/19B-BTi supports IPMI 2.0 through the optional iRIS-2400 module.

The major external device connections include USB 3.0, USB 2.0, serial port, VGA and HDMI connectors. Furthermore, the PPC-F12B/15B/17B/19B-BTi has two full-size/half-size PCIe Mini card slots, allowing installation of a wide variety of PCIe Mini cards, such as Wi-Fi modules and mSATA modules.

PPC-F12B/15B/17B/19B-BTi Panel PC

1.2 Model Variation

The PPC-F12B/15B/17B/19B-BTi series is preinstalled with Intel® Celeron® processor J1900, which has a 10 W TDP. The model numbers and model variations are listed below.

Model	Size	Touchscreen	Memory	Power
PPC-F12B-BTi-J1/2G/R-R10	12"	Resistive	2 GB DDR3L	9 V ~ 36 V DC
PPC-F12B-BTi-J1/2G/PC-R10	12"	Projected capacitive	2 GB DDR3L	9 V ~ 36 V DC
PPC-F15B-BTi-J1/2G/R-R10	15"	Resistive	2 GB DDR3L	9 V ~ 36 V DC
PPC-F15B-BTi-J1/2G/PC-R10	15"	Projected capacitive	2 GB DDR3L	9 V ~ 36 V DC
PPC-F17B-BTi-J1/2G/R-R10	17"	Resistive	2 GB DDR3L	9 V ~ 36 V DC
PPC-F17B-BTi-J1/2G/PC-R10	17"	Projected capacitive	2 GB DDR3L	9 V ~ 36 V DC
PPC-F19B-BTi-J1/2G/R-R10	19"	Resistive	2 GB DDR3L	9 V ~ 36 V DC
PPC-F19B-BTi-J1/2G/PC-R10	19"	Projected capacitive	2 GB DDR3L	9 V ~ 36 V DC

Table 1-1: Model Variation

1.3 Features

Some of the features of the PPC-F12B/15B/17B/19B-BTi panel PC include:

- Supports iRIS remote management solution
- Robust aluminum IP 65 compliant front bezel
- Aesthetic ultra-thin bezel for seamless panel mount installation
- Supports 2 GHz quad-core Intel® Celeron® processor J1900
- Pre-installed with 2 GB of DDR3L memory (system max. 8 GB)
- Two full-size/half-size PCIe Mini card slots (one supports mSATA SSD)
- Supports SATA 6Gb/s interface for both SATA HDD and SSD
- HDMI and VGA interfaces support dual video output
- Rich I/O interfaces, including two RS-232, one RS-232/422/485, two USB 3.0, two USB 2.0 and audio line-out jack
- Wide voltage power input
- Optional wireless LAN module
- RoHS compliant

1.4 Front Panel

The front side of the PPC-F12B/15B/17B/19B-BTi (**Figure 1-2**) is a flat panel LCD touchscreen surrounded by an aluminum frame.

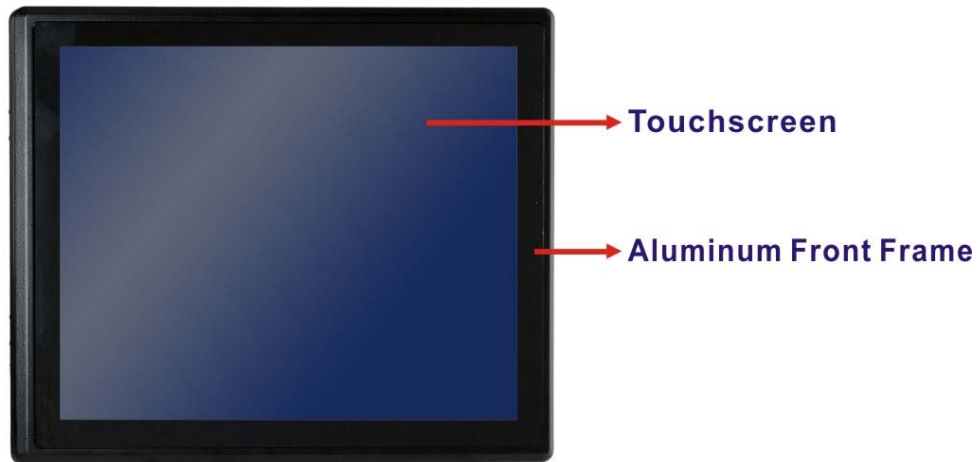

Figure 1-2: Front View

1.5 Rear Panel

The rear panel has a fan vent, four VESA 100x100 mounting holes and several retention screws. The VESA 100x100 mounting holes are circled in **Figure 1-3**.

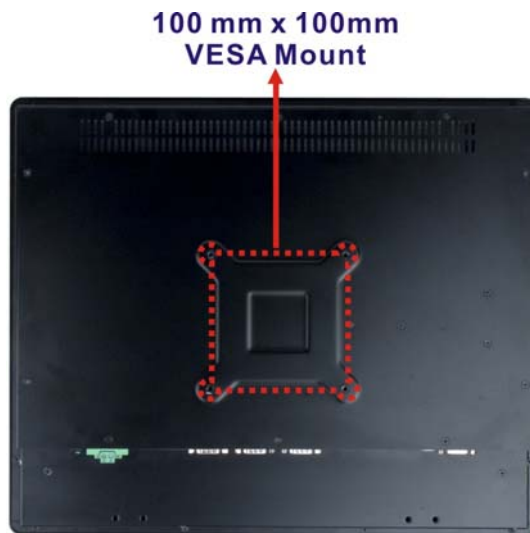

Figure 1-3: PPC-F17B-BTi Rear View

PPC-F12B/15B/17B/19B-BTi Panel PC

1.6 Bottom Panel

The bottom panel has the following interfaces:

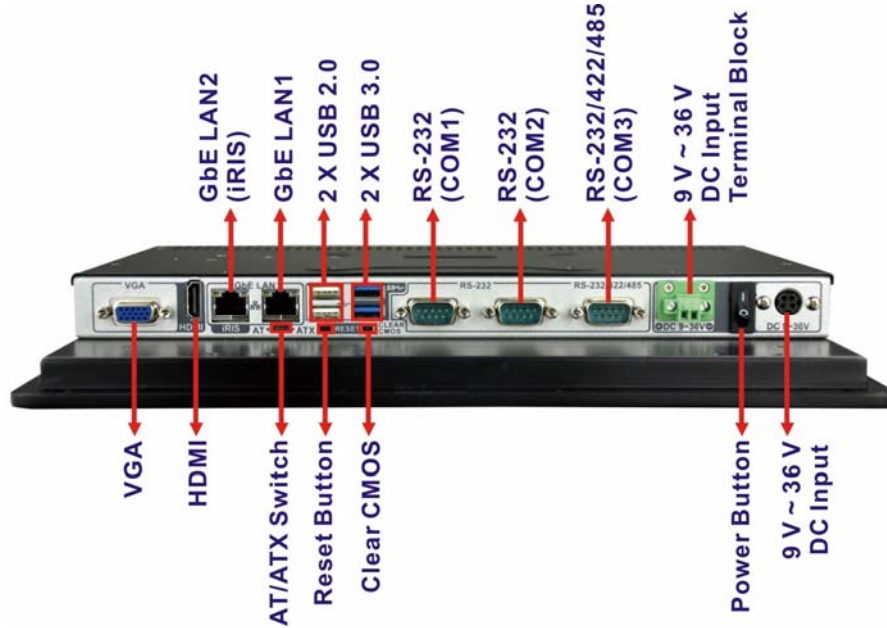

Figure 1-4: PPC-F12B-BTi Bottom View

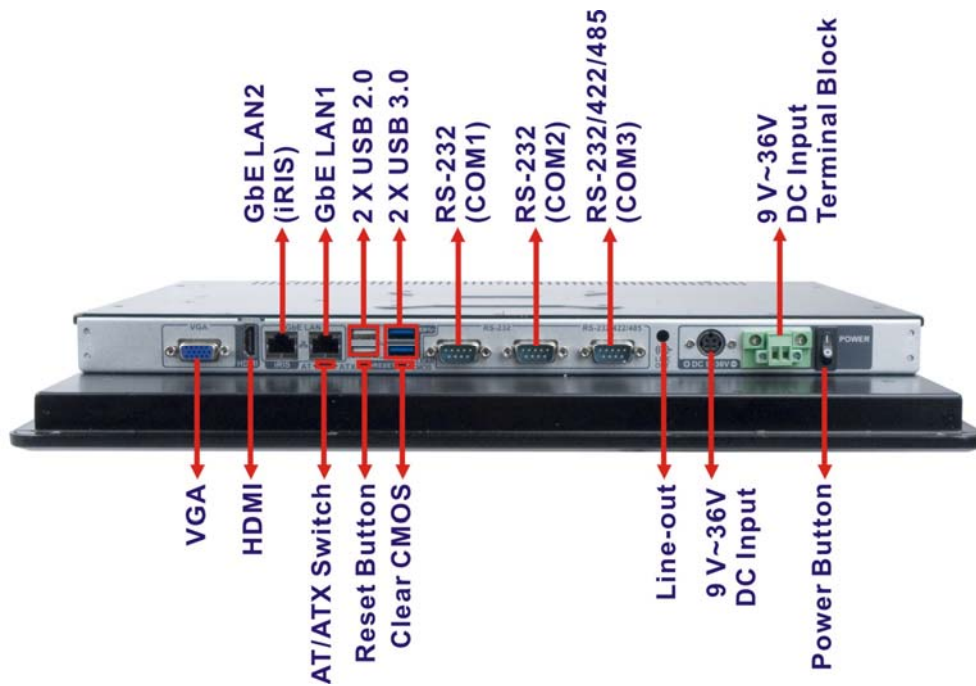

Figure 1-5: PPC-F15B/F17B-BTi Bottom View

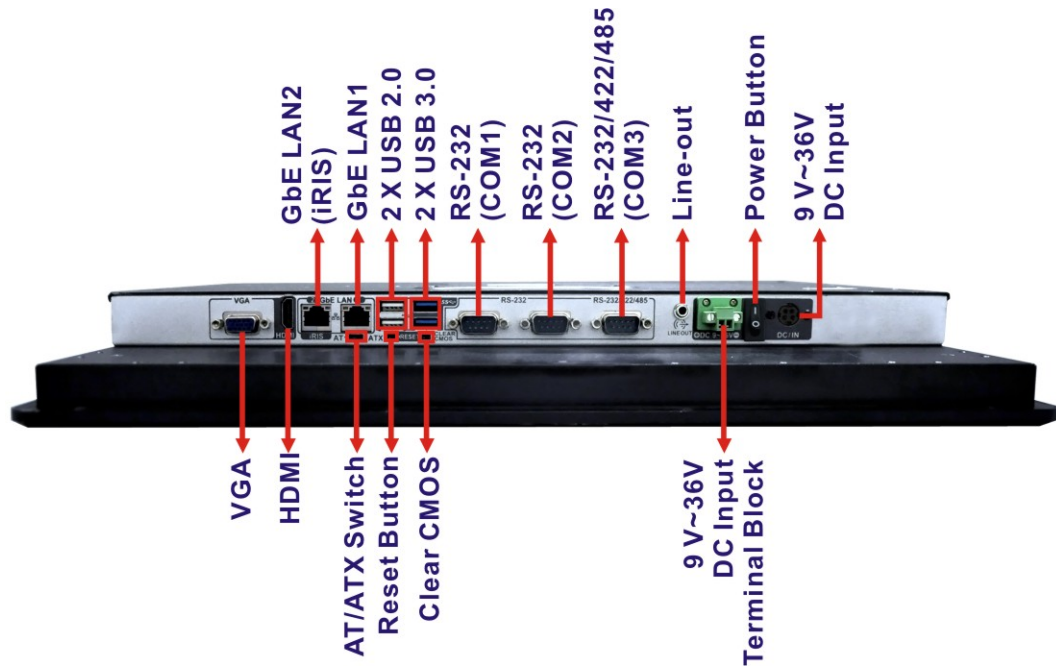

Figure 1-6: PPC-F19B-BTi Bottom View



WARNING:

Before installing the operating system, the user must enter the **Boot** BIOS menu first and choose which operating system will be installed. Otherwise the USB 2.0 and USB 3.0 ports may not be detected. Please refer to **Figure 3-50** and **Section 5.6**.

PPC-F12B/15B/17B/19B-BTi Panel PC

1.7 Dimensions

1.7.1 PPC-F12B-BTi Dimensions

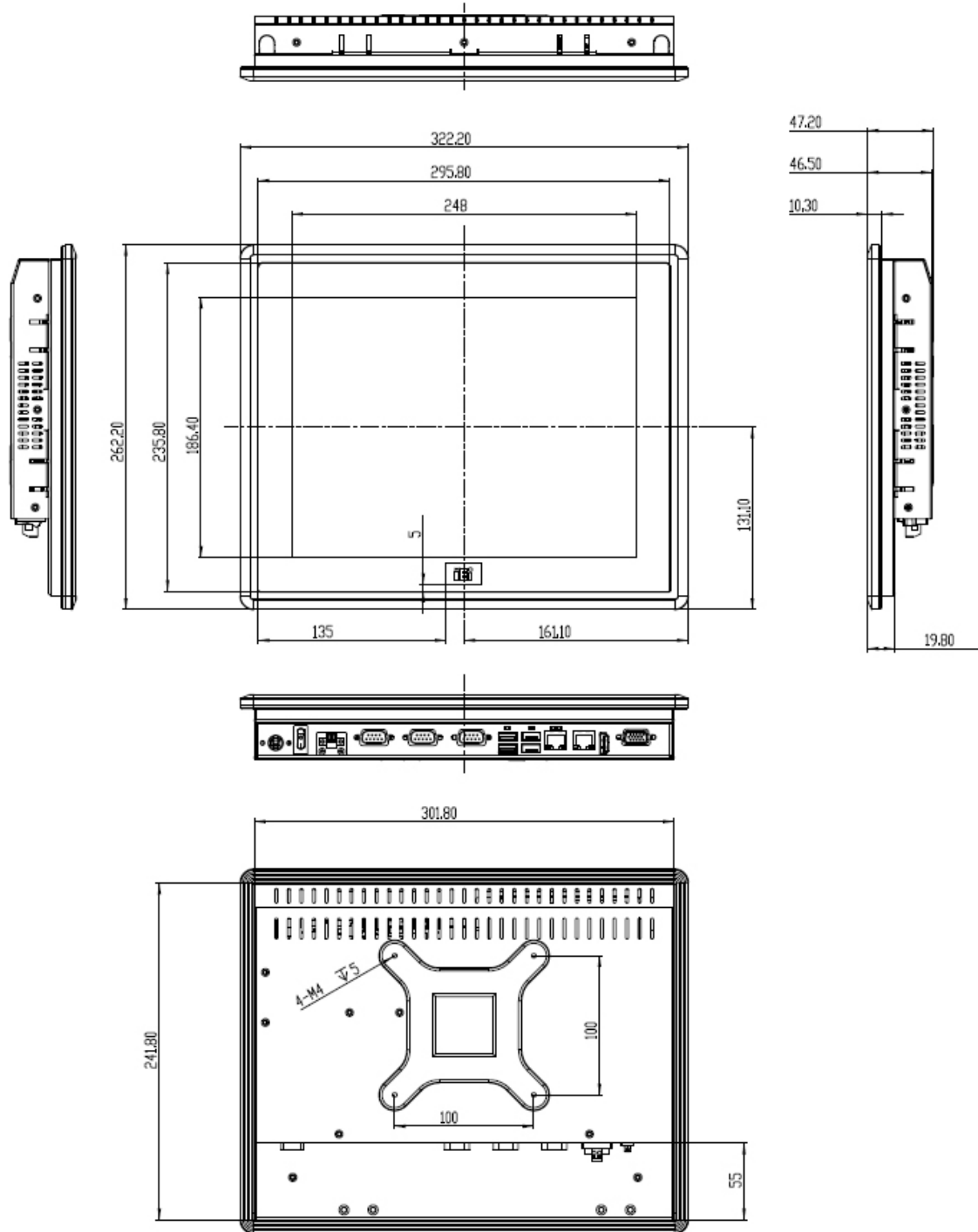

Figure 1-7: PPC-F12B-BTi Dimensions (mm)

PPC-F12B/15B/17B/19B-BTi Panel PC

1.7.3 PPC-F17B-BTi Dimensions

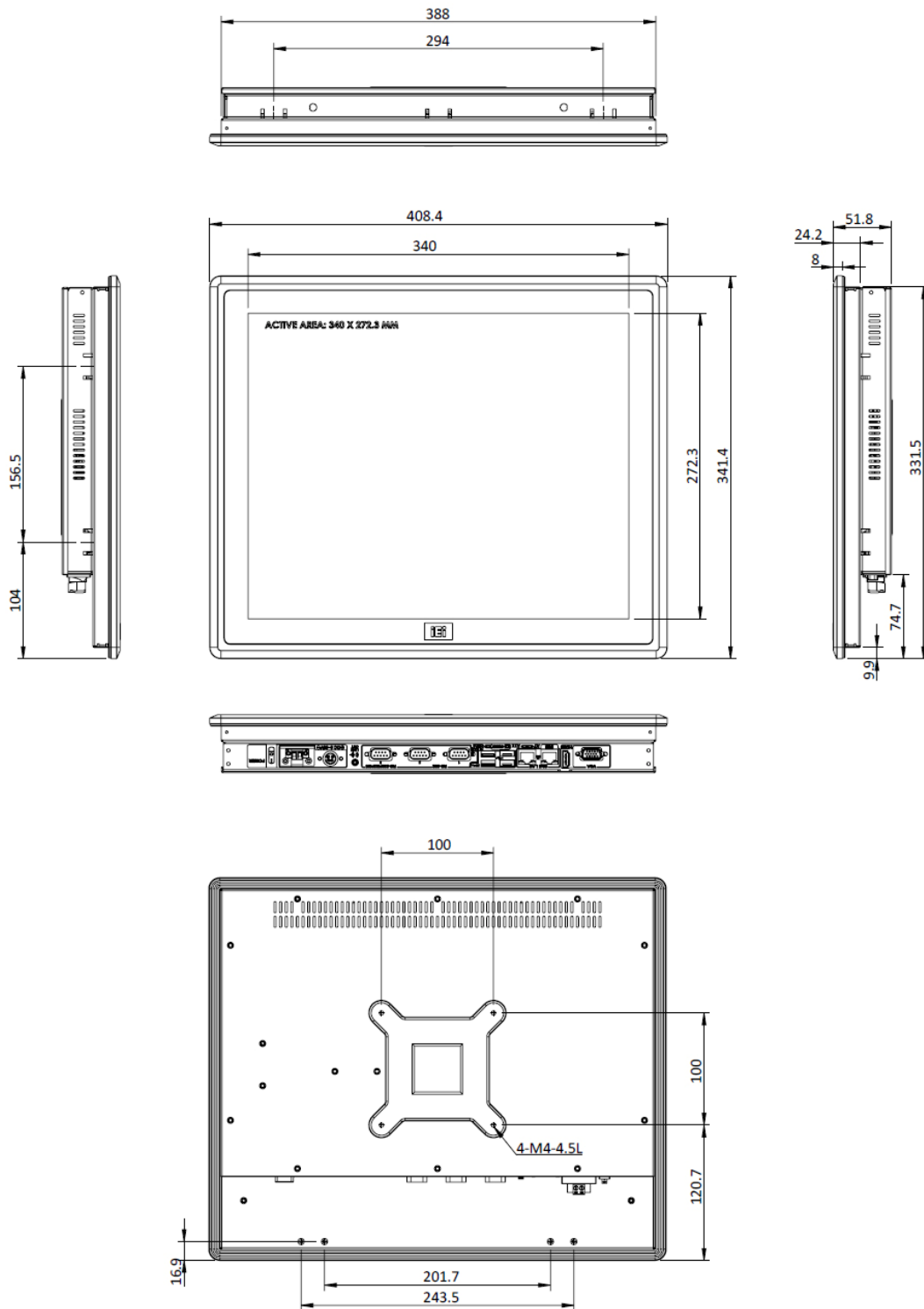

Figure 1-9: PPC-F17B-BTi Dimensions (mm)

1.7.4 PPC-F19B-BTi Dimensions

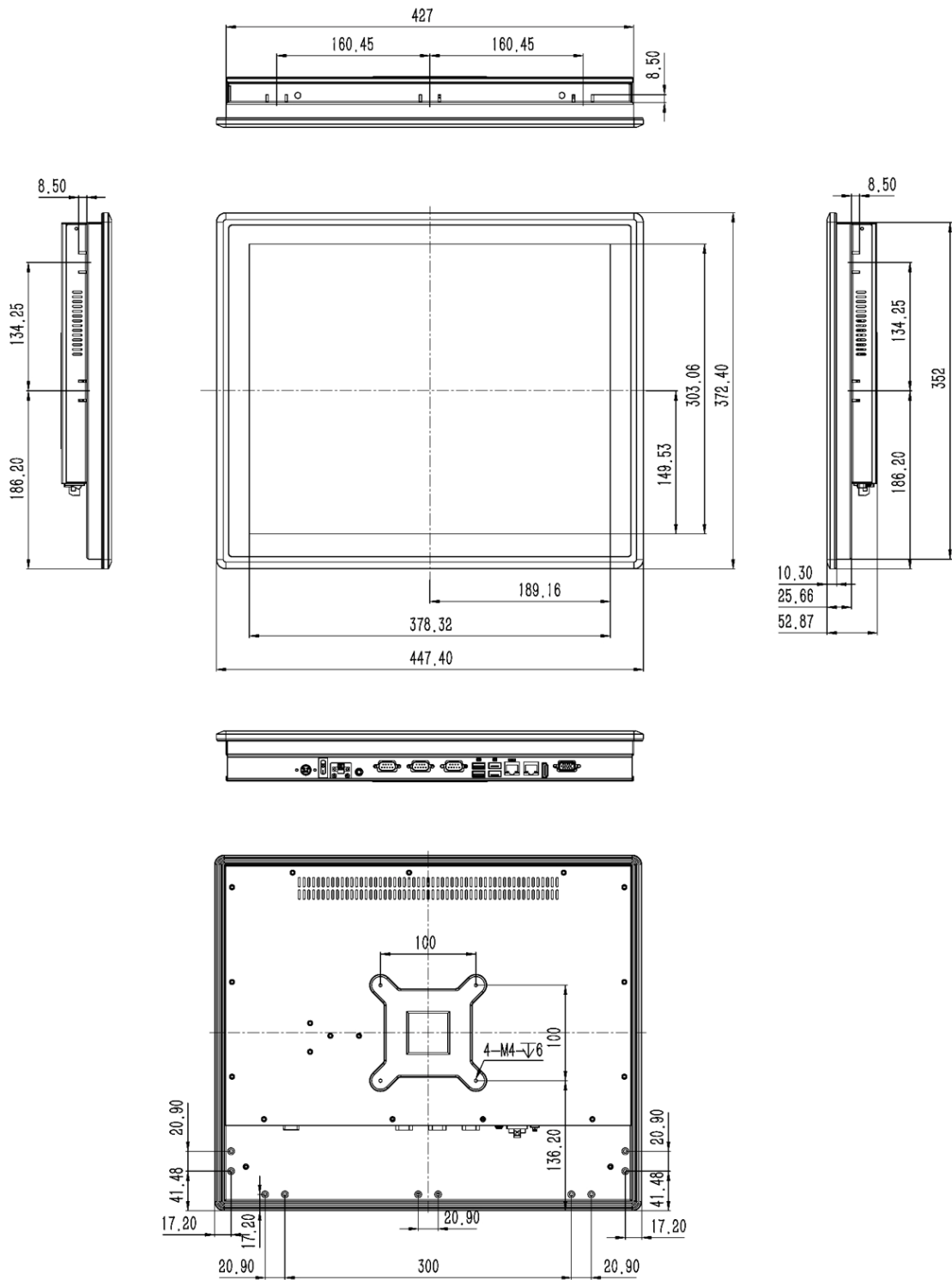

Figure 1-10: PPC-F19B-BTi Dimensions (mm)

PPC-F12B/15B/17B/19B-BTi Panel PC

1.8 Specifications

The technical specifications are listed in **Table 1-2**.

	PPC-F12B-BTi	PPC-F15B-BTi	PPC-F17B-BTi	PPC-F19B-BTi
LCD Display	12" (4:3)	15" (4:3)	17" (5:4)	19" (5:4)
Max. Resolution	1024 (W) x 768 (H)	1024 (W) x 768 (H)	1280 (W) x 1024 (H)	1280 (W) x 1024 (H)
Brightness	600 cd/m ²	400 cd/m ²	350 cd/m ²	350 cd/m ²
Contrast Ratio	700:1	700:1	800:1	1000:1
LCD Color	16.2M	16.2M	16.7M	16.7M
Pixel Pitch (mm)	0.24 x 0.24	0.29 x 0.29	0.26 x 0.26	0.294 x 0.294
Viewing Angle (H-V)	160°/140°	160°/140°	170°/160°	170°/160°
Backlight MTBF	50,000 hours	50,000 hours	50,000 hours	50,000 hours
SBC Model	PPCMB-BT-R10			
CPU (SoC)	Intel® Celeron® processor J1900 (quad-core, up to 2.42 GHz)			
Memory	Two 204-pin DDR3L SO-DIMM slots (system max. 8 GB) Pre-installed with 2 GB of memory			
Touchscreen	5-wire resistive type or 2-point projected capacitive type			
Drive Bay	One 2.5" HDD/SSD drive bay			
Wireless	Optional wireless LAN module supports 802.11a/b/g/n/ac and Bluetooth v4.0			
iRIS Remote Management Solution	iRIS-2400 slot			
Expansion	One Full-size/half-size PCIe Mini card slot (with PCIe and USB signal) One Full-size PCIe Mini card slot colay mSATA (SATA2 only) (with PCIe and USB signal)			
Mounting	VESA 100 mm x 100 mm Panel, wall, rack, stand and arm			
Construction Material	Aluminum front cover and sheet metal rear cover			
Enclosure Color	Black			

	PPC-F12B-BTi	PPC-F15B-BTi	PPC-F17B-BTi	PPC-F19B-BTi
I/O Ports, Switches and Buttons	1 x VGA connector 1 x HDMI connector 2 x RJ-45 GbE connectors (one supports iRIS) 2 x USB 3.0 2 x USB 2.0 2 x RS-232 (COM1 and COM2) 1 x RS-232/422/485 (COM3) 1 x Audio line-out jack (15", 17" and 19" models only) 1 x Power jack (4-pin) 1 x Power terminal block (2-pin) 1 x Power switch 1 x Clear CMOS button 1 x Reset button 1 x AT/ATX switch			
Power Input	9 V ~ 36 V DC			
Power Consumption	40 W	41 W	42 W	33 W
Operating Temperature (with air flow)	-10°C ~ 50°C			
Storage Temperature	-20°C ~ 60°C			
Humidity	10% ~ 95%, non-condensing			
IP Level	IP 65 compliant front panel			
Safety and EMC	CE, FCC Class A			
Dimensions (H x W x D) (mm)	262.2 x 322.2 x 47.2	303.0 x 378.5 x 46.2	341.4 x 408.4 x 51.8	372.4 x 447.4 x 53
Net Weight	3.2 kg	3.1 kg	5.0 kg	6.5 kg

Table 1-2: System Specifications

Chapter

2

Unpacking

2.1 Unpacking

To unpack the panel PC, follow the steps below:



WARNING!









The front side LCD screen has a protective plastic cover stuck to the screen. Only remove the plastic cover after the panel PC has been properly installed. This ensures the screen is protected during the installation process.

- Step 1:** Use box cutters, a knife or a sharp pair of scissors that seals the top side of the external (second) box.
- Step 2:** Open the external (second) box.
- Step 3:** Use box cutters, a knife or a sharp pair of scissors that seals the top side of the internal (first) box.
- Step 4:** Lift the monitor out of the boxes.
- Step 5:** Remove both polystyrene ends, one from each side.
- Step 6:** Pull the plastic cover off the panel PC.
- Step 7:** Make sure all the components listed in the packing list are present.

PPC-F12B/15B/17B/19B-BTi Panel PC

2.2 Packing List

The PPC-F12B/15B/17B/19B-BTi panel PC is shipped with the following components:

Quantity	Item	Image
1	PPC-F12B/15B/17B/19B-BTi panel PC	
1	Power cord (part number varies by regions)	
1	Power adapter (60 W)	
1	Screw pack	
1	Touch pen (resistive type models only)	
1	SO-DIMM heatsreader	
1	Thermal pad for SO-DIMM heatsreader	
1	User manual and driver CD	

Quantity	Item	Image
1	One Key Recovery CD	

Table 2-1: Packing List

If any of the above items are missing or damaged, contact the distributor or sales representative immediately.

2.3 Optional Items

The following items are optional accessories for the PPC-F12B/15B/17B/19B-BTi:

Item	PPC-F12B-BTi	PPC-F15B-BTi	PPC-F17B-BTi	PPC-F19B-BTi
Arm	ARM-31	ARM-31	ARM-31	ARM-31
Panel mounting kit	FPK-09-R10	FPK-10-R10	FPK-10-R10	FPK-11-R10
Rack mounting kit	FRK12-R10	FRK15-R10	FRK17-R10	FRK19P-R10
Stand	STAND-C12 STAND-A12	STAND-C19 STAND-A19	STAND-C19 STAND-A19	STAND-C19 STAND-A19
Wall mounting kit	WK-190MS-R10	WK-190MS-R10	WK-190MS-R10	WK-190MS-R10
Wi-Fi kit	PPC-WL-KIT02-R10	PPC-WL-KIT03-R10	PPC-WL-KIT03-R10	PPC-WL-KIT03-R10
iRIS remote management module	iRIS-2400-R10	iRIS-2400-R10	iRIS-2400-R10	iRIS-2400-R10

Table 2-2: Optional Items

Chapter

3

Installation

3.1 Anti-static Precautions

**WARNING:**

Failure to take ESD precautions during the maintenance of the panel PC may result in permanent damage to the panel PC and severe injury to the user.

Electrostatic discharge (ESD) can cause serious damage to electronic components, including the PPC-F12B/15B/17B/19B-BTi. Dry climates are especially susceptible to ESD. It is therefore critical that whenever the PPC-F12B/15B/17B/19B-BTi is accessed internally, or any other electrical component is handled, the following anti-static precautions are strictly adhered to.

- **Wear an anti-static wristband:** Wearing a simple anti-static wristband can help to prevent ESD from damaging the board.
- **Self-grounding:** Before handling the board, touch any grounded conducting material. During the time the board is handled, frequently touch any conducting materials that are connected to the ground.
- **Use an anti-static pad:** When configuring the PPC-F12B/15B/17B/19B-BTi, place it on an anti-static pad. This reduces the possibility of ESD damaging the PPC-F12B/15B/17B/19B-BTi.
- **Only handle the edges of the PCB:** When handling the PCB, hold the PCB by the edges.

3.2 Installation Precautions

When installing the panel PC, please follow the precautions listed below:

- **Power turned off:** When installing the panel PC, make sure the power is off. Failing to turn off the power may cause severe injury to the body and/or damage to the system.
- **Certified Engineers:** Only certified engineers should install and modify onboard functionalities.

PPC-F12B/15B/17B/19B-BTi Panel PC

- **Mounting:** The PPC-F12B/15B/17B/19B-BTi is a heavy device. When mounting the system onto a rack, panel, wall or arm, please make sure that at least two people are assisting with the procedure.
- **Anti-static Discharge:** If a user open the rear panel of the panel PC, to configure the jumpers or plug in added peripheral devices, ground themselves first and wear an anti-static wristband.

3.3 Preinstalled Components

The following components are all preinstalled.

- Motherboard
- TFT LCD
- Touchscreen

Preinstalled OEM customizations may include the following.

- CPU
- DDR3L memory module
- HDD

3.4 Installation and Configuration Steps

The following installation steps must be followed.

Step 1: Unpack the panel PC.

Step 2: Install an additional DDR3L SO-DIMM (if necessary).

Step 3: Install HDD, mSATA SSD and iRIS-2400 module.

Step 4: Mount the panel PC.

Step 5: Connect peripheral devices to the bottom panel of the panel PC.

Step 6: Configure the system.

3.5 Removing the Back Cover

Remove the back cover retention screws on the back cover. Lift the cover up to remove.



NOTE:

The number of retention screws on the back cover varies by models.

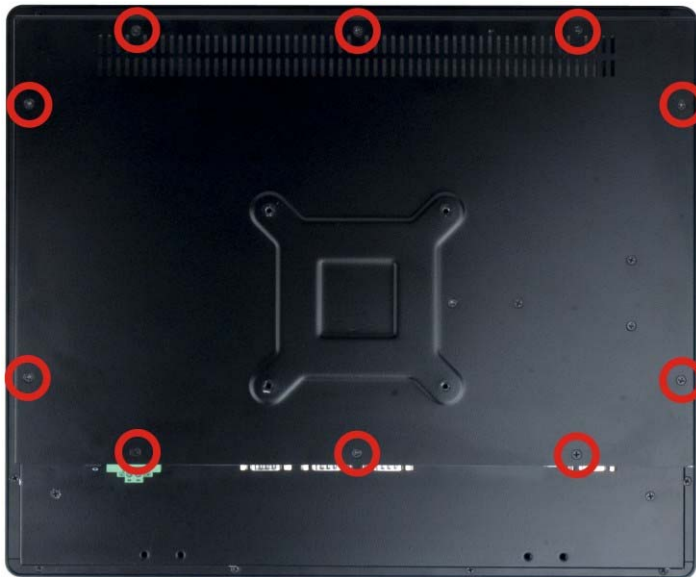

Figure 3-1: PPC-F17B-BTi Back Cover Retention Screws

3.6 SO-DIMM Installation

The PPC-F12B/15B/17B/19B-BTi series has two DDR3 SO-DIMM slots. All models are preinstalled with a 2 GB DDR3L SO-DIMM in one of the slots. To add an additional SO-DIMM, please follow the steps below.

Step 1: Remove the back cover. See Section 3.5.

Step 2: Locate the SO-DIMM socket. See Figure 3-2.

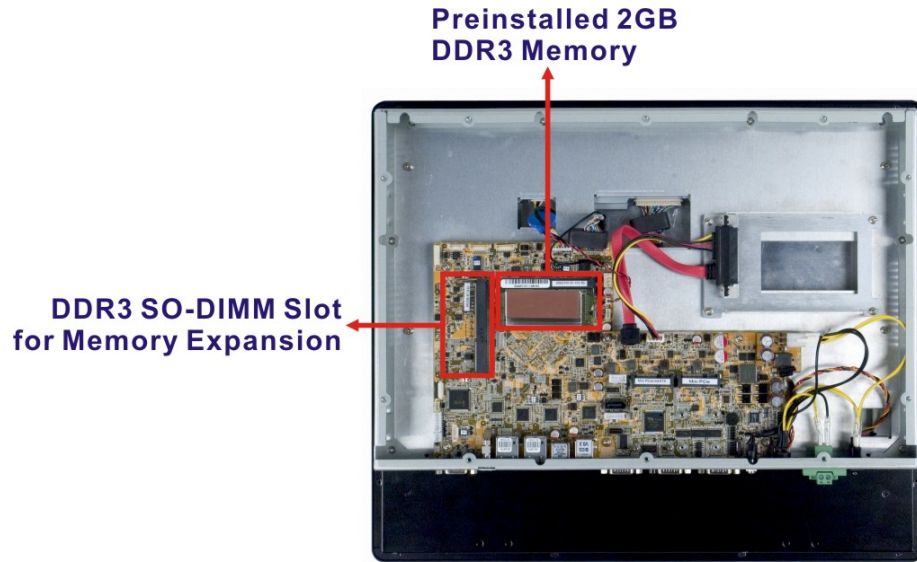

Figure 3-2: SO-DIMM Slot Location

Step 3: Install the SO-DIMM heatspreader on a SO-DIMM. Attach the thermal pad onto the heatspreader and insert a SO-DIMM into the heatspreader.

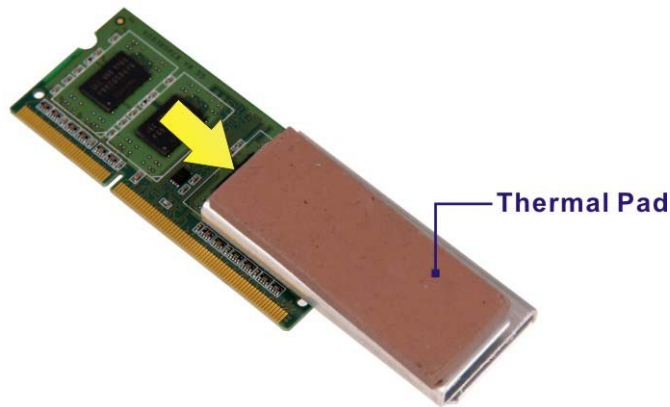

Figure 3-3: SO-DIMM Heatspreader Installation



NOTE:

Please remove the sticker from the SO-DIMM before installing the heatspreader for better heat dissipation.

Step 4: Align the SO-DIMM with the socket. Align the notch on the memory with the notch on the memory socket.

Step 5: Insert the SO-DIMM. Push the memory in at a 20° angle (Figure 3-4)

Step 6: Seat the SO-DIMM. Gently push downwards and the arms clip into place. See Figure 3-4.

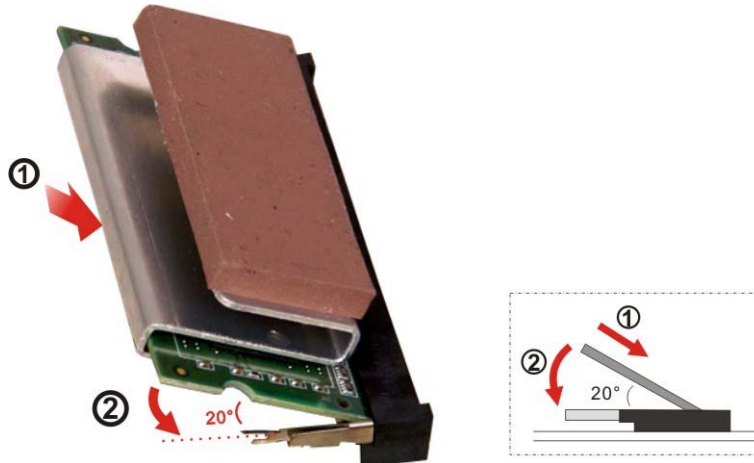

Figure 3-4: SO-DIMM Installation

3.7 HDD Installation

To install a 2.5" HDD into the PPC-F12B/15B/17B/19B-BTi series, please follow the steps below:

Step 1: Remove the back cover. See Section 3.5.

Step 2: Remove the HDD bracket from the PPC-F12B/15B/17B/19B-BTi. The HDD bracket is secured on the panel PC with four retention screws (Figure 3-5).

Remove the four retention screws and disconnect the SATA and SATA power cables. Lift the bracket off the panel PC.

PPC-F12B/15B/17B/19B-BTi Panel PC

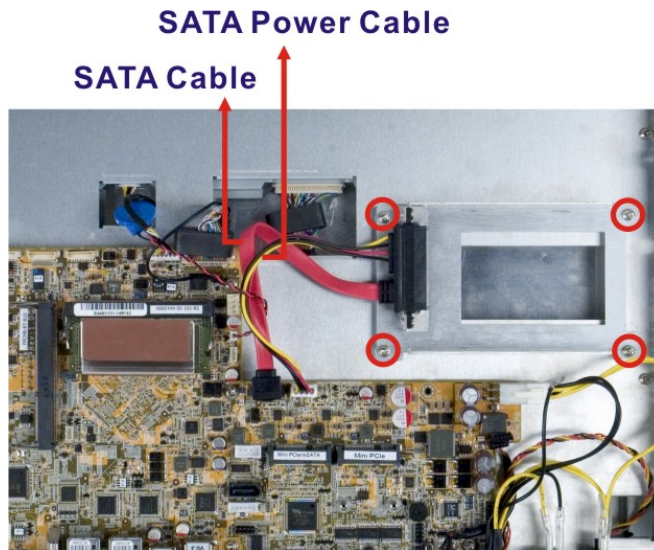

Figure 3-5: PPC-F17B-BTi HDD Bracket Retention Screws

Step 3: Attach the hard drive to the bracket. To do this, slide the hard drive onto the bracket until it connects with the SATA connector at the back.

Step 4: Secure the hard drive to the bracket. Secure the hard drive to the bracket with four retention screws (Figure 3-6).

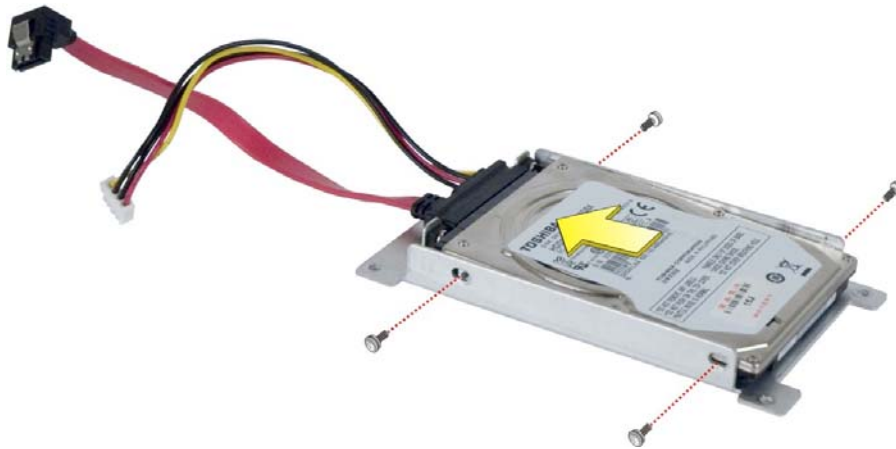

Figure 3-6: HDD Retention Screws

Step 5: Reinstall the HDD bracket into the PPC-F12B/15B/17B/19B-BTi and fasten the four hard drive bracket screws (Figure 3-7) Connect the SATA and SATA power cables.

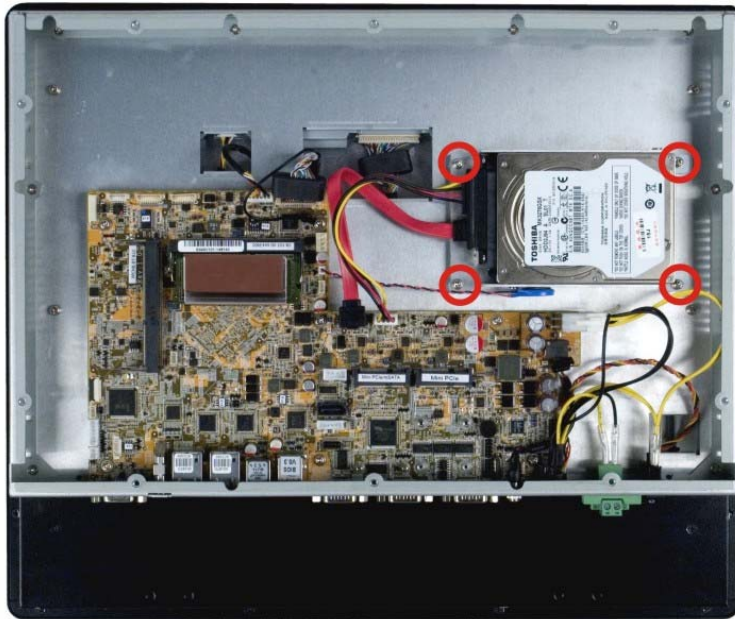

Figure 3-7: PPC-F17B-BTi HDD Installation

3.8 mSATA Module Installation

One of the PCIe Mini card slots on the motherboard of the PPC-F12B/15B/17B/19B-BTi supports mSATA module. To install an mSATA module, please follow the steps below.

Step 1: Remove the back cover. See **Section 3.5**.

Step 2: Locate the PCIe Mini card slot which supports mSATA. The location of the PCIe Mini card slot is shown in **Figure 3-8**.

PPC-F12B/15B/17B/19B-BTi Panel PC

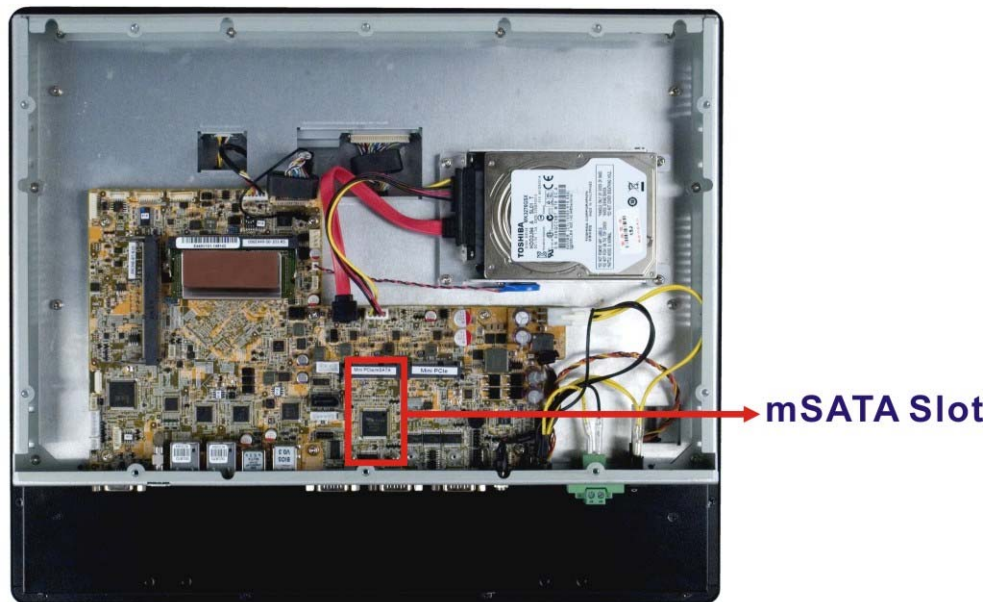

Figure 3-8: PCIe Mini Card Slot which supports mSATA

Step 3: Remove the retention screws. Remove the two retention screws as shown in Figure 3-9.

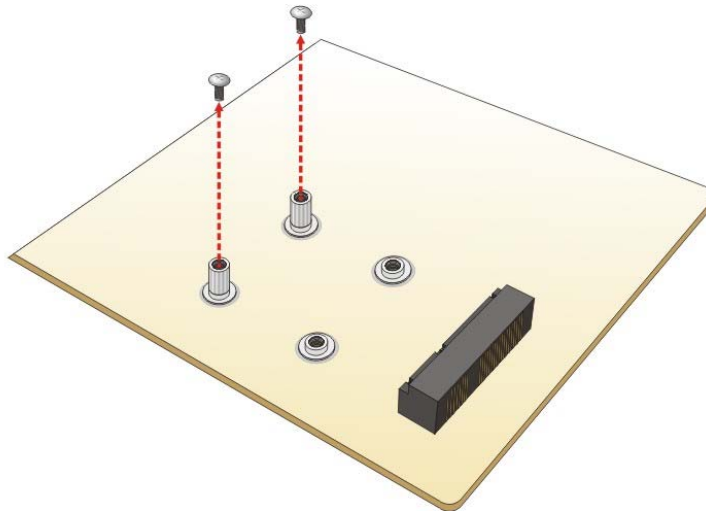

Figure 3-9: Removing the Retention Screws

Step 4: Insert into the socket at an angle. Line up the notch on the card with the notch on the slot. Slide the PCIe Mini card into the socket at an angle of about 20° (Figure 3-10).

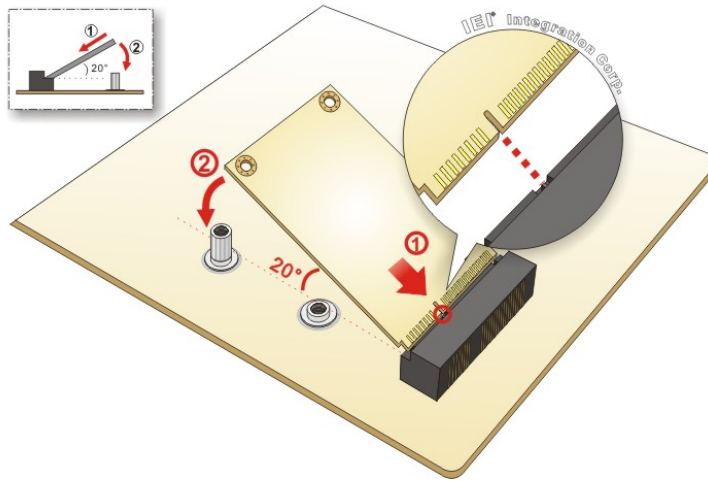

Figure 3-10: Inserting the PCIe Mini Card into the Slot at an Angle

Step 5: Secure the PCIe Mini card. Secure the PCIe Mini card with the retention screws previously removed (Figure 3-11).

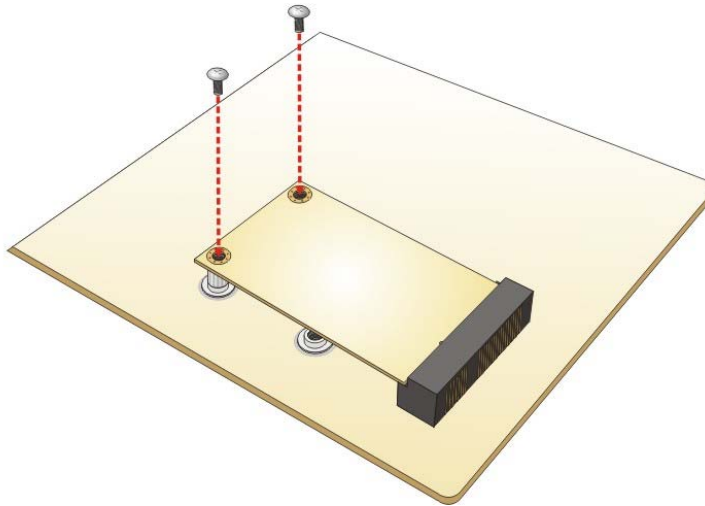

Figure 3-11: Securing the PCIe Mini Card

3.9 iRIS-2400 Module Installation

**WARNING:**

The iRIS-2400 module slot is designed to install the iRIS-2400 module only. DO NOT install other modules into the iRIS-2400 module slot. Doing so may cause damage to the PPC-F12B/15B/17B/19B-BTi.

To install the iRIS-2400 module, please follow the steps below.

Step 1: Remove the back cover. See **Section 3.5**.

Step 2: Remove the motherboard. The iRIS-2400 module slot is located on the solder side of the motherboard. To install the iRIS-2400 module, the motherboard must be removed first. Remove the motherboard retention screws and the D-sub jack screws located on the bottom panel as shown in **Figure 3-12**.



Figure 3-12: Motherboard Retention Screws

Step 3: Locate the iRIS-2400 module slot. Lift the motherboard and turn it over to locate the slot.

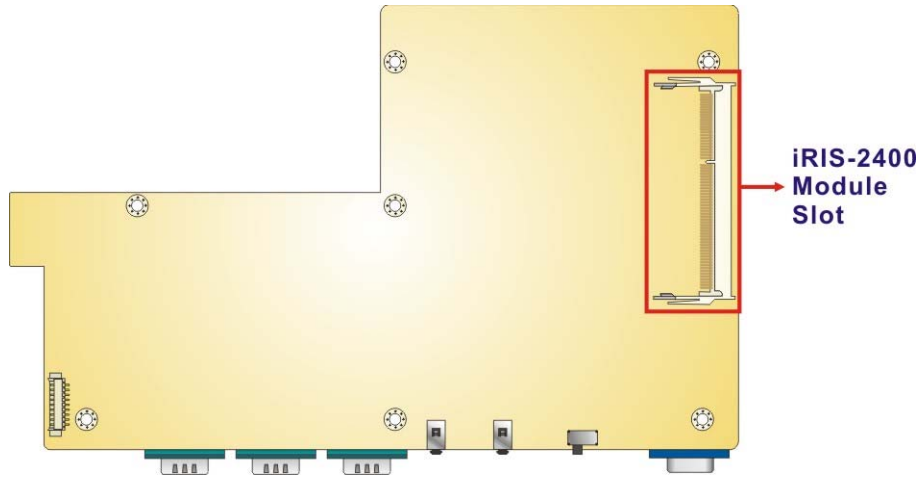

Figure 3-13: iRIS-2400 Module Slot Location

Step 4: Align the iRIS-2400 module with the iRIS-2400 module slot. Align the notch on the module with the notch on the iRIS-2400 module slot (**Figure 3-14**).

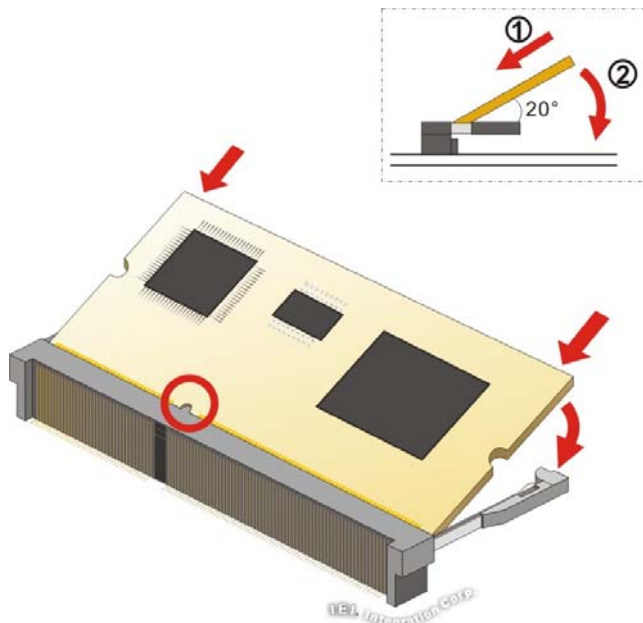

Figure 3-14: iRIS-2400 Module Installation

Step 5: Insert the iRIS-2400 module. Push the module in at a 20° angle (**Figure 3-14**).

PPC-F12B/15B/17B/19B-BTi Panel PC

Step 6: Seat the iRIS-2400 module. Gently push downwards and the arms clip into place (Figure 3-14).



NOTE:

After installing the iRIS-2400 module, use the LAN port with iRIS label (Figure 1-5) to establish a network connection. Please refer to Section 3.19 for IPMI setup procedures.

3.10 Wireless LAN Module Installation (Optional)

To install the optional wireless LAN (WLAN) module, please follow the steps below.

Step 1: Remove the back cover. See Section 3.5.

Step 2: Remove the two knockouts for antenna installation. The two knockouts are located on the top panel of the PPC-F12B/15B/17B/19B-BTi.

PPC-F12B-BTi



PPC-F15B/17B/19B-BTi

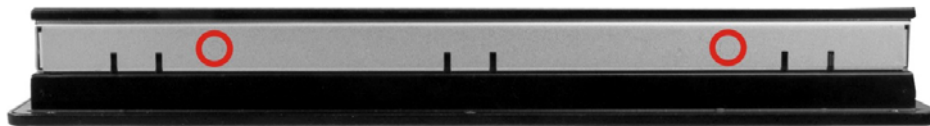

Figure 3-15: Knockouts on Top Panel for Wireless Antennas

Step 3: Locate the PCIe Mini slot (Figure 3-16).

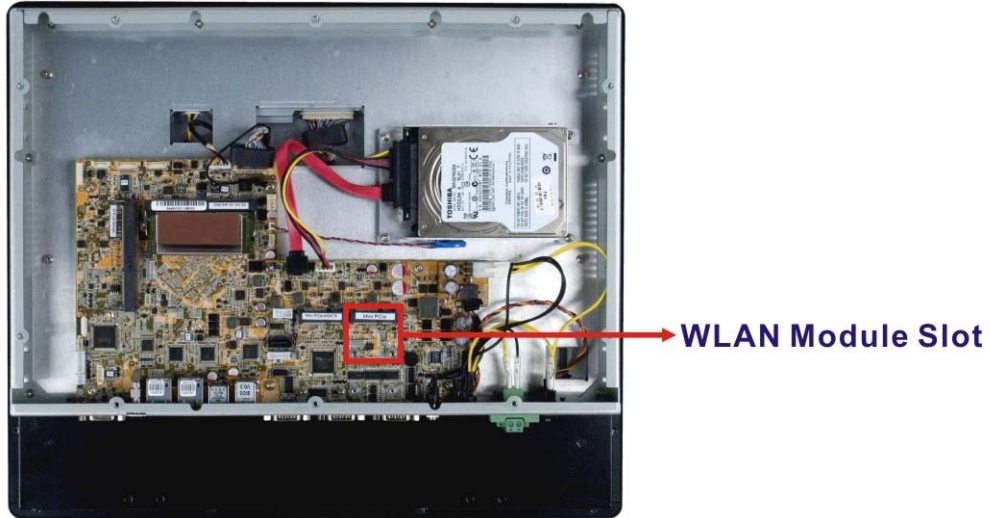

Figure 3-16: PCIe Mini Slot Location

Step 4: Line up the notch on the WLAN module with the notch on the slot. Slide the WLAN module into the slot at an angle of about 20° (**Figure 3-17**).

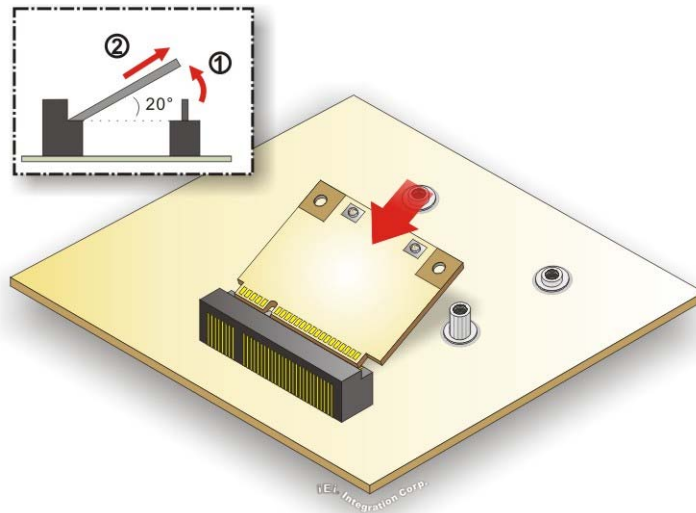

Figure 3-17: Inserting the WLAN Module

Step 5: Secure the WLAN module with two retention screws.

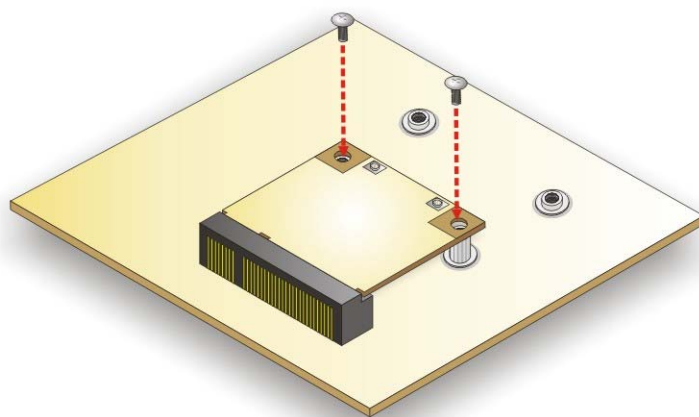

Figure 3-18: Securing WLAN Module

Step 6: Connect the two RF cables to the antenna connectors on the WLAN module (Figure 3-19).

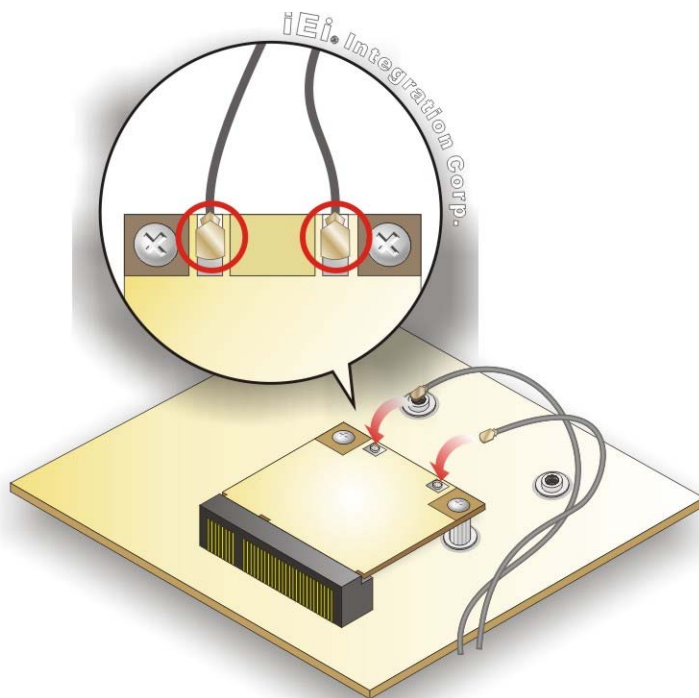

Figure 3-19: Connecting RF Cables

Step 7: Remove the nut and washer from the SMA connector at the other end of the RF cable.

Step 8: Insert the SMA connector to the antenna connector holes on the top panel.

Step 9: Secure the SMA connector by inserting the washer and tightening it with nut.

Step 10: Install the external antenna.

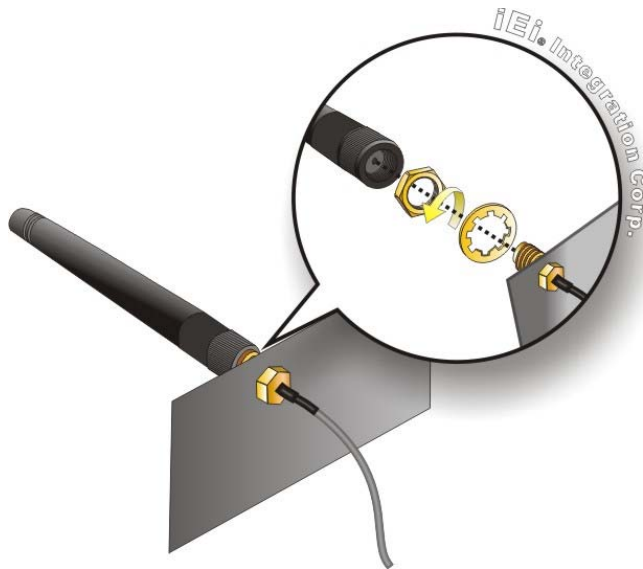

Figure 3-20: Securing SMA Connector and External Antenna Installation

PPC-F12B/15B/17B/19B-BTi Panel PC

3.11 AT/ATX Mode Selection

AT and ATX power modes can both be used on the PPC-F12B/15B/17B/19B-BTi panel PC. The selection is made through an AT/ATX switch on the I/O interface panel. The system is set to AT mode by default. The switch is shown below.



Figure 3-21: AT/ATX Mode Selection

		AT/ATX Switch	
		AT (Default)	ATX
Power Switch Position	Off (O)	The system remains off.	The system remains off.
	On (I)	The system turns on once power is connected.	Depends on the state selected in the Restore AC Power Loss BIOS option (see Section 5.4.2).

3.12 Mounting the System



WARNING!

When mounting the PPC-F12B/15B/17B/19B-BTi panel PC, it is advisable to have more than one person help with the installation to prevent accidental damage to the panel and avoid personal injury.

The methods of mounting the PPC-F12B/15B/17B/19B-BTi are:

- Wall mounting
- Panel mounting
- Rack mounting
- Arm mounting
- Stand mounting

The mounting methods are described in the following sections.

3.12.1 Wall Mounting

To mount the PPC-F12B/15B/17B/19B-BTi panel PC onto a wall, please follow the steps below.

Step 1: Select the location on the wall for the wall-mounting bracket.

Step 2: Carefully mark the locations of the four bracket screw holes on the wall.

Step 3: Drill four pilot holes at the marked locations on the wall for the bracket retention screws.

Step 4: Align the wall-mounting bracket screw holes with the pilot holes.

Step 5: Secure the mounting bracket to the wall by inserting the retention screws into the four pilot holes and tightening them (**Figure 3-22**).

PPC-F12B/15B/17B/19B-BTi Panel PC

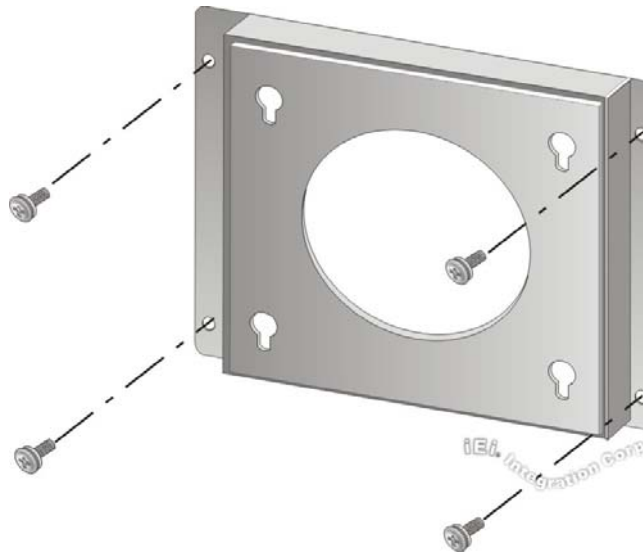

Figure 3-22: Wall-mounting Bracket

- Step 6:** Insert the four monitor mounting screws provided in the wall mounting kit into the four screw holes on the rear panel of the monitor and tighten until the screw shank is secured against the rear panel (**Figure 3-23**).
- Step 7:** Align the mounting screws on the monitor rear panel with the mounting holes on the bracket.
- Step 8:** Carefully insert the screws through the holes and gently pull the monitor downwards until the monitor rests securely in the slotted holes (**Figure 3-23**). Ensure that all four of the mounting screws fit snugly into their respective slotted holes.



NOTE:

In the diagram below the bracket is already installed on the wall.

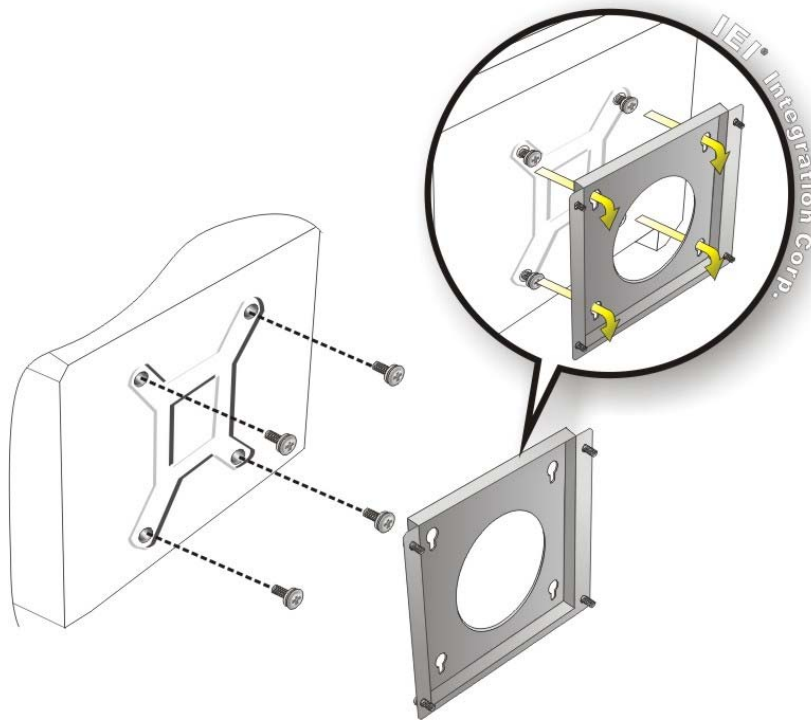

Figure 3-23: Mount the Chassis

- Step 9:** Secure the panel PC with the wall-mounting kit. To do this, stick the protective cushion to the wall-mounting kit first. Then, put the wall-mounting kit on the top panel of the panel PC. Carefully mark the location of the wall-mounting kit screw holes on the wall. Drill a pilot hole at the marked location on the wall. Secure the wall-mounting kit to the wall by inserting a retention screw into the pilot hole on the wall (**Figure 3-24**). This step is to avoid the panel PC being pushed apart from the wall-mounting bracket accidentally.

PPC-F12B/15B/17B/19B-BTi Panel PC

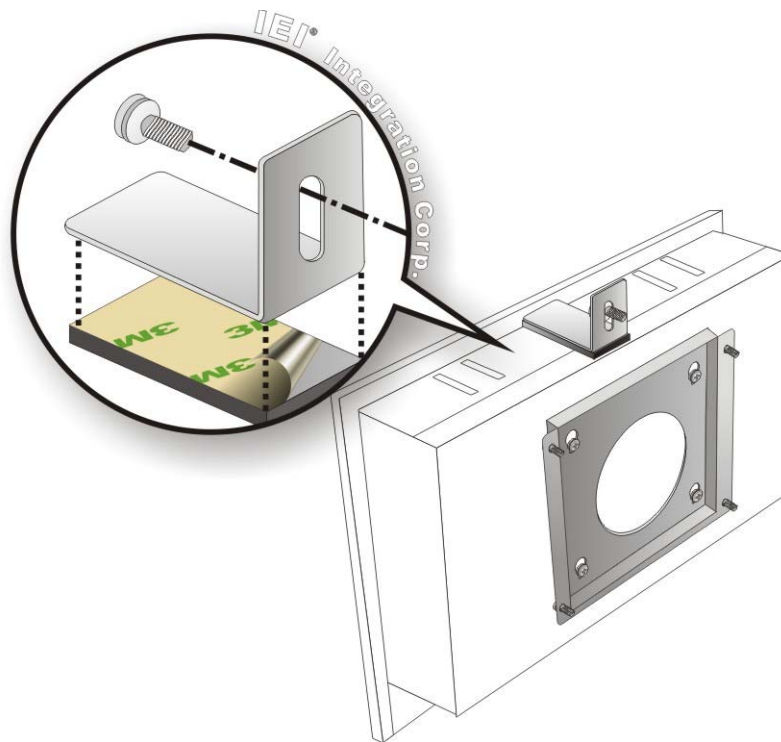

Figure 3-24: Secure the Chassis

3.12.2 Panel Mounting

To mount the PPC-F12B/15B/17B/19B-BTi panel PC into a panel, please follow the steps below.

Step 1: Install two mounting brackets onto the rear panel (Figure 3-25).

**NOTE:**

For the PPC-F19B-BTi panel PC, **five** mounting brackets must be installed (three along the bottom and one along each side).

See Figure 3-26



Figure 3-25: PPC-F17B-BTi Mounting Bracket Installation

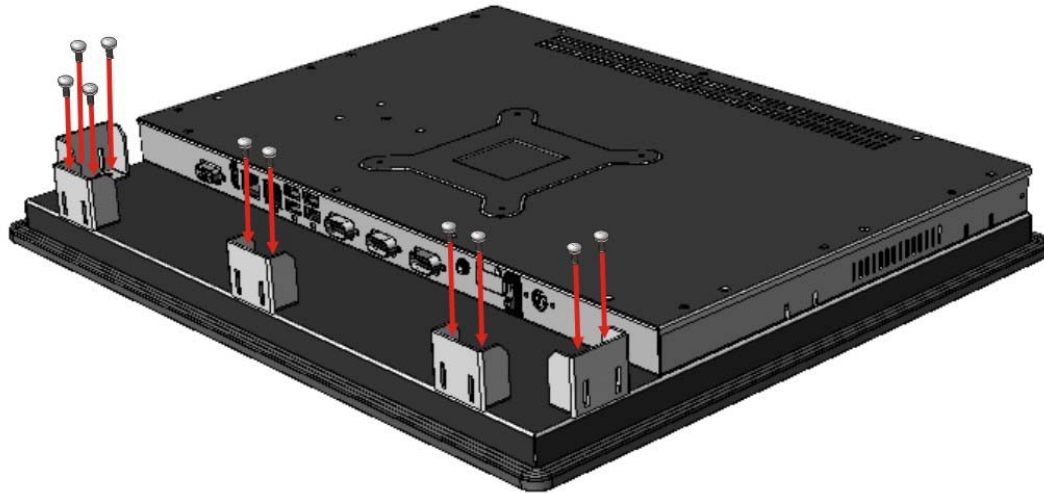

Figure 3-26: PPC-F19B-BTi Mounting Bracket Installation

- Step 2:** Select the position on the panel to mount the PPC-F12B/15B/17B/19B-BTi.
- Step 3:** Cut out a section of the panel that corresponds to the rear panel dimensions of the PPC-F12B/15B/17B/19B-BTi. The recommended cutout sizes are shown below (**Figure 3-27**, **Figure 3-28**, **Figure 3-29** and **Figure 3-30**).

PPC-F12B/15B/17B/19B-BTi Panel PC

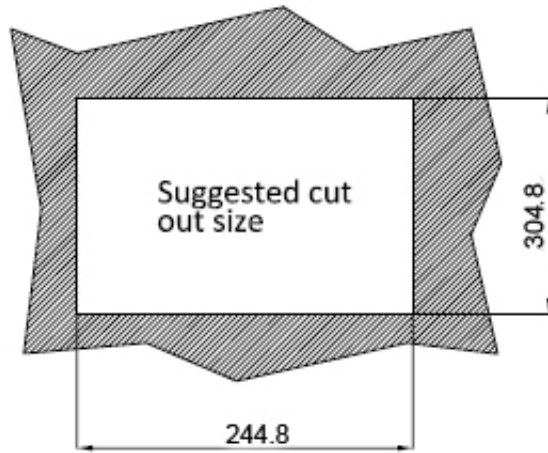

Figure 3-27: PPC-F12B-BTi Panel Cutout Dimensions

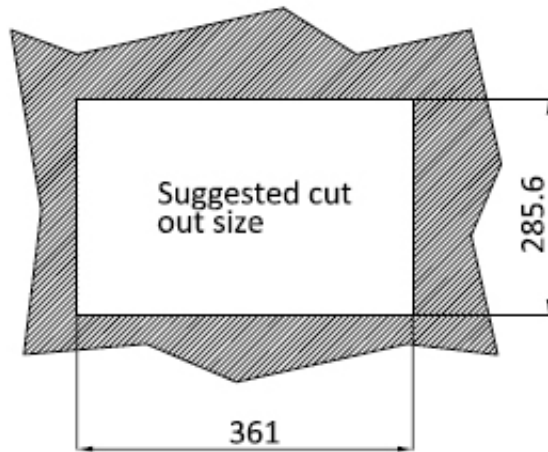

Figure 3-28: PPC-F15B-BTi Panel Cutout Dimensions

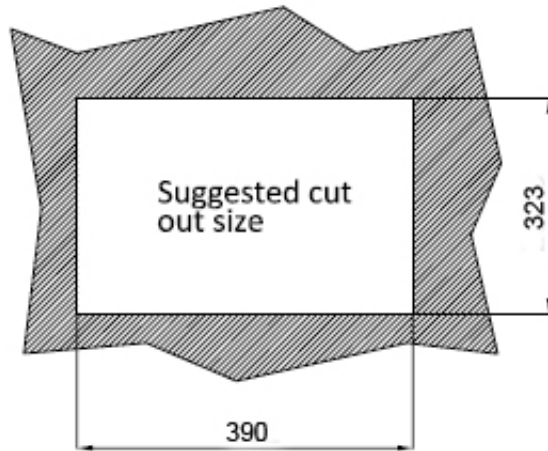

Figure 3-29: PPC-F17B-BTi Panel Cutout Dimensions

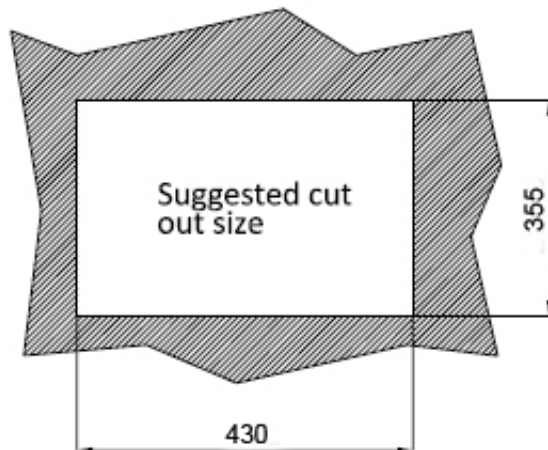

Figure 3-30: PPC-F19B-BTi Panel Cutout Dimensions

- Step 4:** Slide the PPC-F12B/15B/17B/19B-BTi through the hole until the aluminum frame is flush against the panel.
- Step 5:** Insert the mounting clamps into the mounting brackets and pre-formed holes along the edges of the PPC-F12B/15B/17B/19B-BTi, behind the aluminum frame (**Figure 3-31**). The required number of mounting clamps may vary by models.
- Step 6:** Tighten the screws that pass through the mounting clamps until the plastic caps at the front of all the screws are firmly secured to the panel (**Figure 3-31**).

PPC-F12B/15B/17B/19B-BTi Panel PC

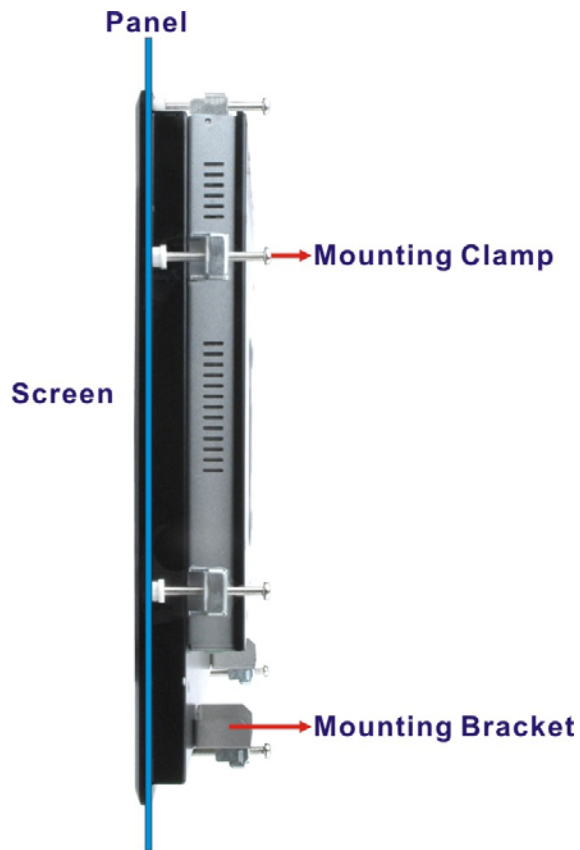

Figure 3-31: Tighten the Mounting Clamp Screws

3.12.3 Rack and Cabinet Installation

The PPC-F12B/15B/17B/19B-BTi flat panel PC can be installed into a cabinet or rack. The installation procedures are similar to the panel mounting installation. To do this, please follow the steps described in the following sections.

**NOTE:**

When purchasing the cabinet/rack installation bracket, make sure it is compatible with both the PPC-F12B/15B/17B/19B-BTi flat panel PC and the rack/cabinet into which the PPC-F12B/15B/17B/19B-BTi is installed.

3.12.3.1 Rack Mounting for F12B, F15B and F17B

Step 1: Install two mounting brackets onto the rear panel (**Figure 3-32**).



Figure 3-32: PPC-F17B-BTi Mounting Bracket Installation

Step 2: Slide the rear of the PPC-F12B/15B/17B-BTi flat panel PC through the rack/cabinet bracket until the aluminum frame is flush against the front of the bracket (**Figure 3-33**).

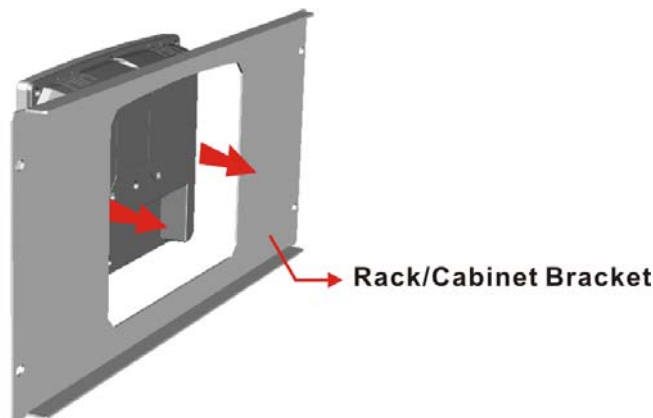

Figure 3-33: The Rack/Cabinet Bracket

Step 3: Insert the mounting clamps into the mounting brackets and pre-formed holes along the edges of the PPC-F12B/15B/17B-BTi, behind the aluminum frame (**Figure 3-34**). The required number of mounting clamps may vary by models.

PPC-F12B/15B/17B/19B-BTi Panel PC

Step 4: Tighten the screws that pass through the mounting clamps until the plastic caps at the front of all the screws are firmly secured to the bracket (**Figure 3-34**).

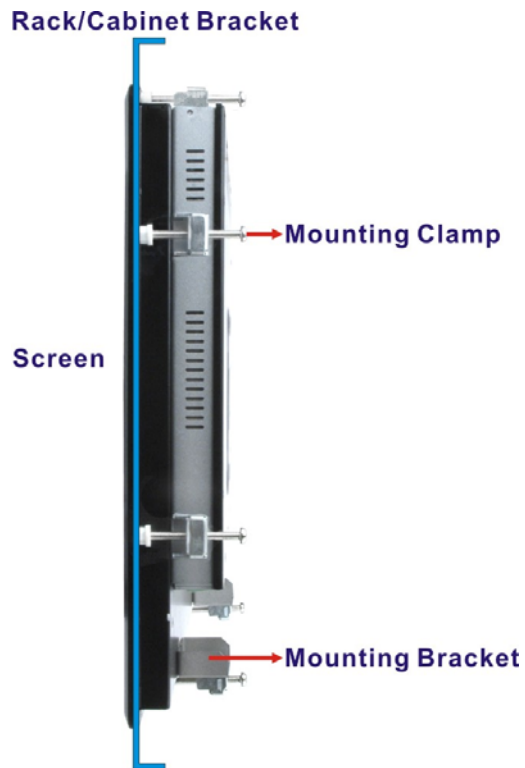

Figure 3-34: Secure the Rack/Cabinet Bracket

Step 5: Slide the PPC-F12B/15B/17B-BTi with the attached rack/cabinet bracket into a rack or cabinet (**Figure 3-35**).

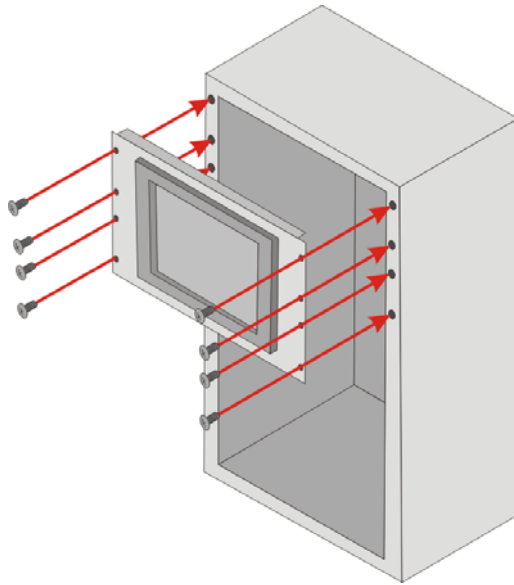

Figure 3-35: Install into a Rack/Cabinet

Step 6: Once the flat panel PC with the attached rack/cabinet bracket has been properly inserted into the rack or cabinet, secure the front of the rack/cabinet bracket to the front of the rack or cabinet (**Figure 3-35**).

3.12.3.2 Rack Mounting for F19B

Step 1: Install three mounting brackets onto the rear panel as shown in **Figure 3-36**.

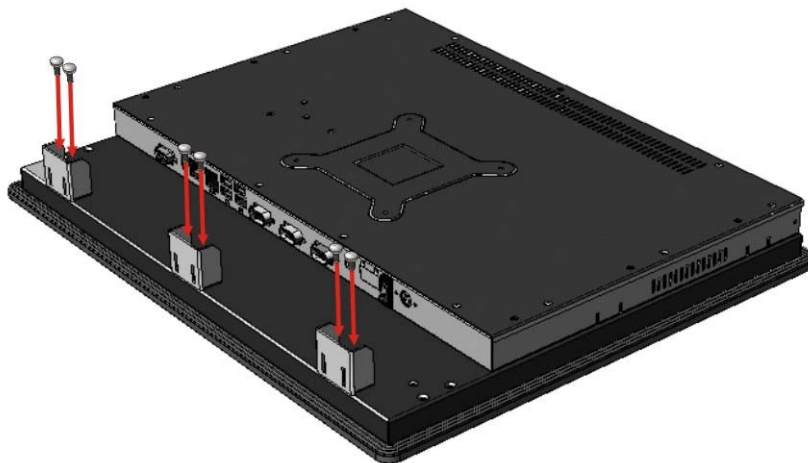

Figure 3-36: PPC-F19B-BTi Mounting Bracket Installation

PPC-F12B/15B/17B/19B-BTi Panel PC

Step 2: Slide the rear of the PPC-F19B-BTi flat panel PC through the rack/cabinet bracket until the aluminum frame is flush against the front of the bracket (Figure 3-37).

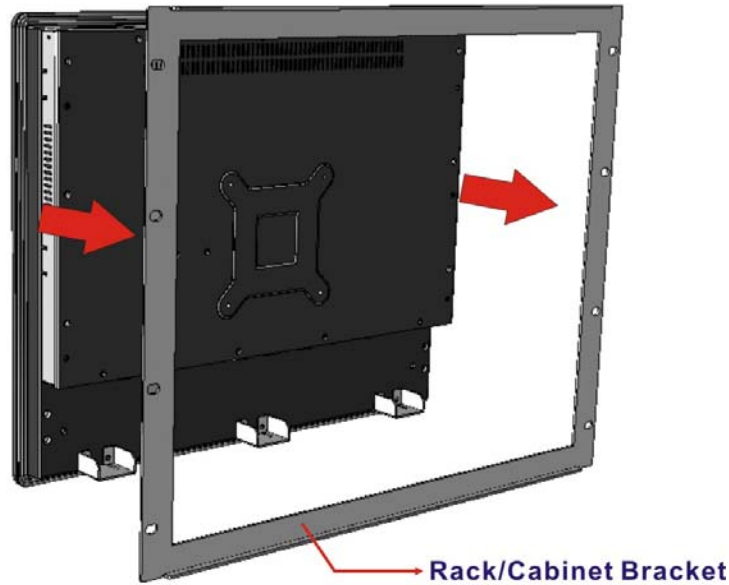

Figure 3-37: Slide through the Rack/Cabinet Bracket

Step 3: Install two side brackets onto the side panels of the PPC-F19B-BTi. Secure each side bracket with three retention screws.

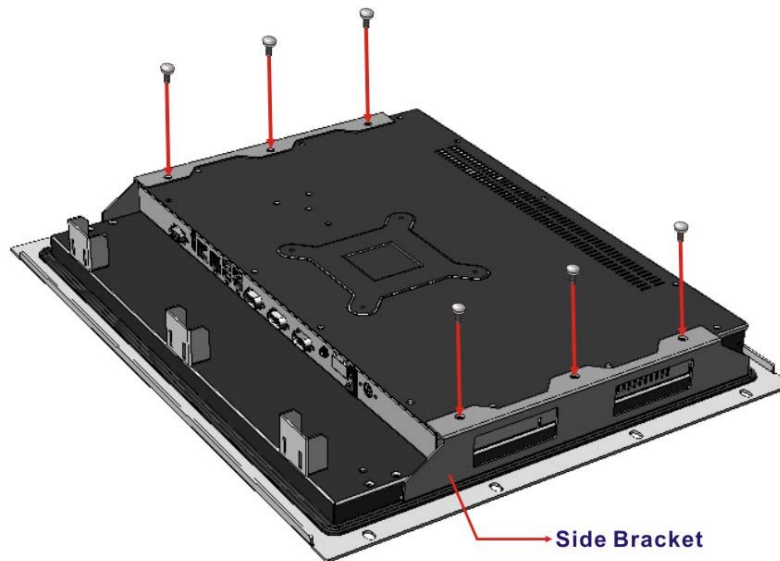

Figure 3-38: PPC-F19B-BTi Side Bracket Installation

Step 4: Insert six mounting clamps into the mounting brackets and pre-formed holes along the top and bottom edges of the PPC-F19B-BTi, behind the aluminum frame (**Figure 3-39**).

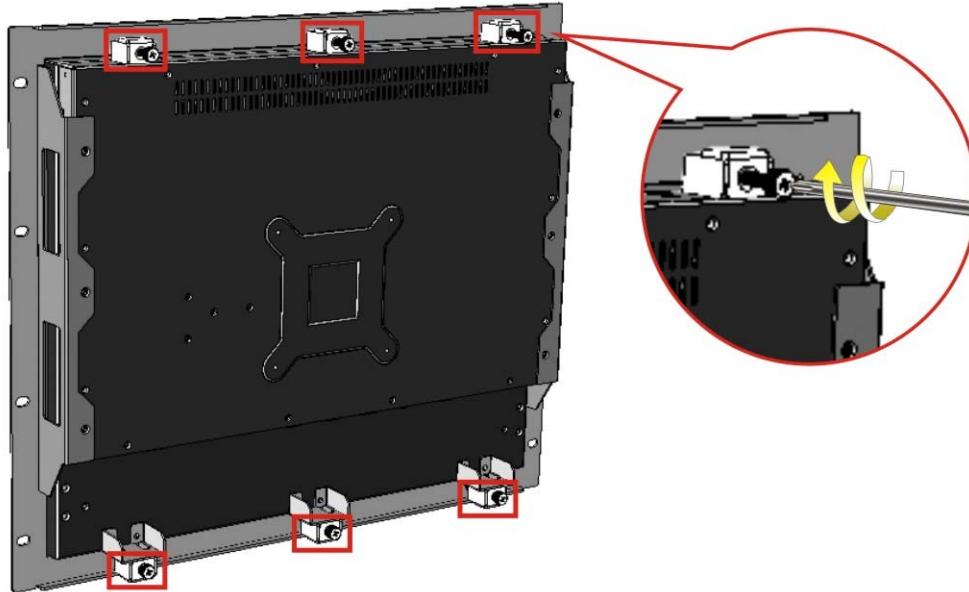

Figure 3-39: Secure the Rack/Cabinet Bracket

Step 5: Tighten the screws that pass through the mounting clamps until the plastic caps at the front of all the screws are firmly secured to the bracket (**Figure 3-39**).

Step 6: Slide the PPC-F19B-BTi with the attached rack/cabinet bracket into a rack or cabinet (**Figure 3-40**).

PPC-F12B/15B/17B/19B-BTi Panel PC

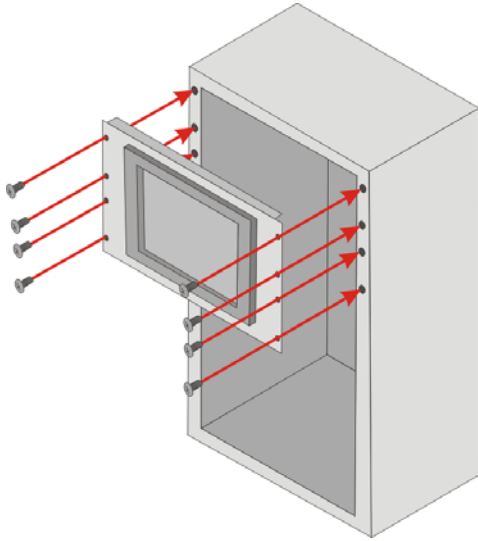

Figure 3-40: Install into a Rack/Cabinet

Step 7: Once the flat panel PC with the attached rack/cabinet bracket has been properly inserted into the rack or cabinet, secure the front of the rack/cabinet bracket to the front of the rack or cabinet (**Figure 3-40**).

3.12.4 Arm Mounting

The PPC-F12B/15B/17B/19B-BTi is VESA (Video Electronics Standards Association) compliant and can be mounted on an arm with a 100 mm interface pad. To mount the PPC-F12B/15B/17B/19B-BTi on an arm, please follow the steps below.

Step 1: The arm is a separately purchased item. Please correctly mount the arm onto the surface it uses as a base. To do this, refer to the installation documentation that came with the mounting arm.



NOTE:

When purchasing the arm please ensure that it is VESA compliant and that the arm has a 100 mm interface pad. If the mounting arm is not VESA compliant, it cannot be used to support the PPC-F12B/15B/17B/19B-BTi panel PC.

Step 2: Once the mounting arm has been firmly attached to its surface, lift the PPC-F12B/15B/17B/19B-BTi panel PC onto the interface pad of the mounting arm.

Step 3: Align the retention screw holes on the mounting arm interface with those in the PPC-F12B/15B/17B/19B-BTi panel PC. The arm mounting retention screw holes of the PPC-F12B/15B/17B/19B-BTi panel PC are shown in **Figure 3-41**.

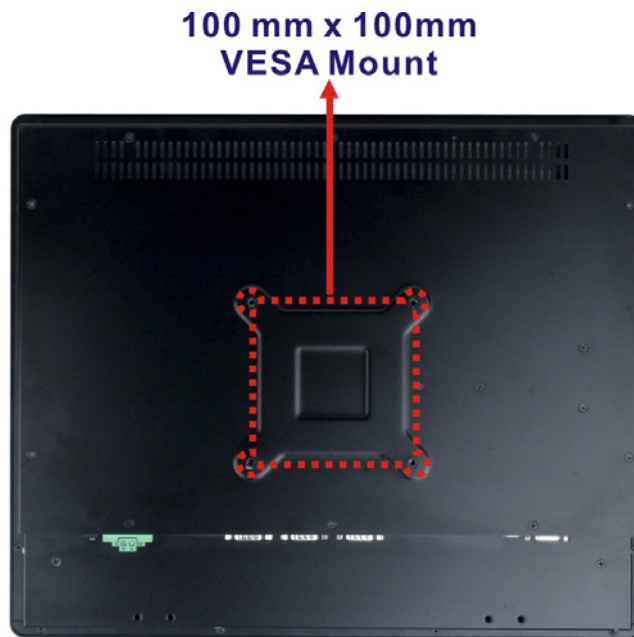

Figure 3-41: Arm Mounting Retention Screw Holes

Step 4: Secure the PPC-F12B/15B/17B/19B-BTi to the interface pad by inserting four retention screws through the mounting arm interface pad and into the PPC-F12B/15B/17B/19B-BTi panel PC.

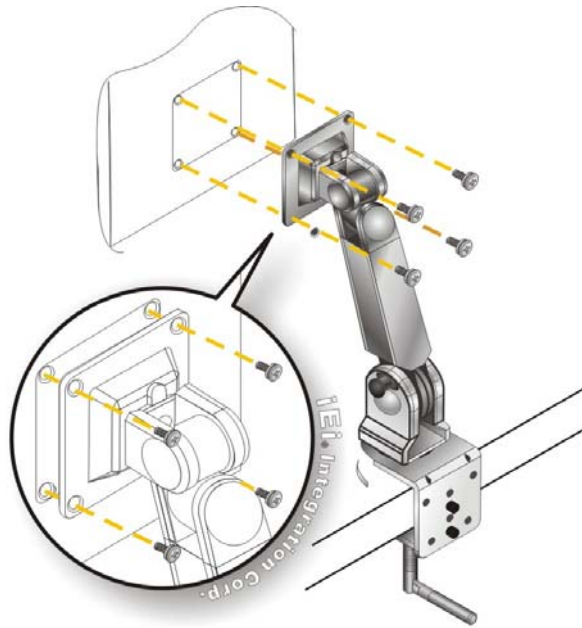

Figure 3-42: Arm Mounting (ARM-11-RS)

3.12.5 Stand Mounting

To mount the PPC-F12B/15B/17B/19B-BTi using the stand mounting kit, please follow the steps below.

Step 1: Locate the screw holes on the rear of the PPC-F12B/15B/17B/19B-BTi. This is where the bracket will be attached.

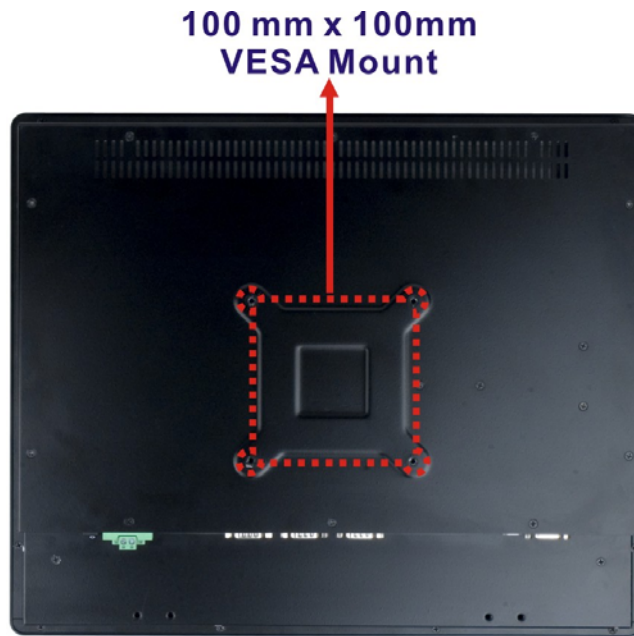

Figure 3-43: Stand Mounting Retention Screw Holes

Step 2: Align the bracket with the screw holes.

Step 3: To secure the bracket to the PPC-F12B/15B/17B/19B-BTi, insert the retention screws into the screw holes and tighten them.

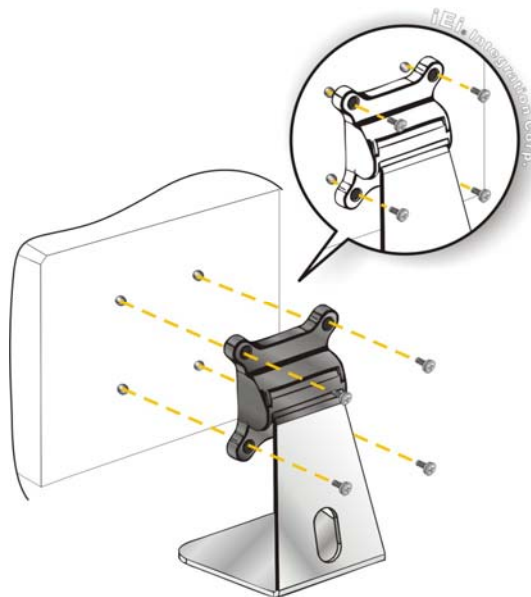

Figure 3-44: Stand Mounting (Stand-Axx)

PPC-F12B/15B/17B/19B-BTi Panel PC

3.13 Serial Device Connection

The PPC-F12B/15B/17B/19B-BTi series has three serial ports, one RS-232/422/484 port and two RS-232 ports. The port locations are shown in **Figure 3-45**. The pinouts of the serial ports are listed in the following sections.

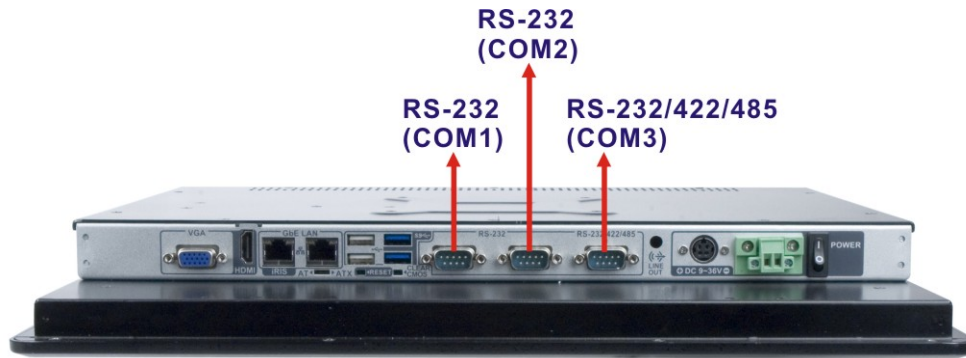

Figure 3-45: Serial Port Locations

3.13.1 RS-232 Serial Ports (COM1, COM2)

The pinouts of the RS-232 serial ports are listed in the following table.

PIN NO.	DESCRIPTION	PIN NO.	DESCRIPTION
1	DCD	2	RXD
3	TXD	4	DTR
5	GND	6	DSR
7	RTS	8	CTS
9	RI		

Table 3-1: RS-232 Serial Port (COM1, COM2) Pinouts

3.13.2 RS-232/422/485 Serial Port (COM3)

The RS-232/422/485 mode selection of COM3 is made through the system BIOS. Please refer to **Section 5.3.1.1.3** for selecting COM port mode.

The COM3 pinouts are listed in the following table.

PIN NO.	RS-232	RS-422	RS-485
1	DCD	TXD422-	TXD485-
2	RXD	TXD422+	TXD485+
3	TXD	RXD422+	--
4	DTR	RXD422-	--
5	GND	--	--
6	DSR	--	--
7	RTS	--	--
8	CTS	--	--
9	RI	--	--

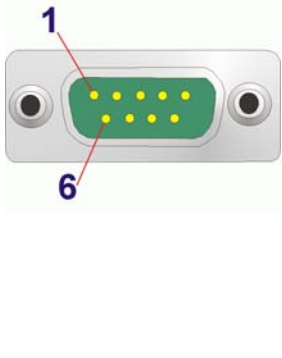

Table 3-2: RS-232/422/485 Serial Port (COM3) Pinouts

3.14 Powering On the System

To power on the system, follow the steps below:

Step 1: Either connect the power adapter to the 4-pin power jack or connect the power cable to the 2-pin power input terminal block. **DO NOT** connect both power connectors to a power source at the same time. The pinouts of the power input connectors are shown below.



Figure 3-46: Power Input Connector Pinouts

PPC-F12B/15B/17B/19B-BTi Panel PC

Step 2: Toggle the power switch on the I/O panel to the constant on position (I) to power on the system. The power switch is not a momentary switch. Please keep the power switch in the constant on position for providing power to the system.



Figure 3-47: Power Connectors and Power Switch

3.15 Reset the System

The reset button enables users to reboot the system when the system is turned on. The reset button location is shown in **Figure 3-48**. Press the reset button to reboot the system.



Figure 3-48: Reset Button Location

3.16 Clear CMOS

If the PPC-F12B/15B/17B/19B-BTi fails to boot due to improper BIOS settings, the clear CMOS button clears the CMOS data and resets the system BIOS information. To do this, push the clear CMOS button for three seconds, and then restart the system. The clear CMOS button location is shown in **Figure 3-49**.



Figure 3-49: Clear CMOS Button Location

3.17 OS Installation



WARNING:

Before installing the operating system, the user must enter the **Boot** BIOS menu first and choose which operating system will be installed. Otherwise the USB 2.0 and USB 3.0 ports may not be detected. Please refer to **Figure 3-50** and **Section 5.6**.

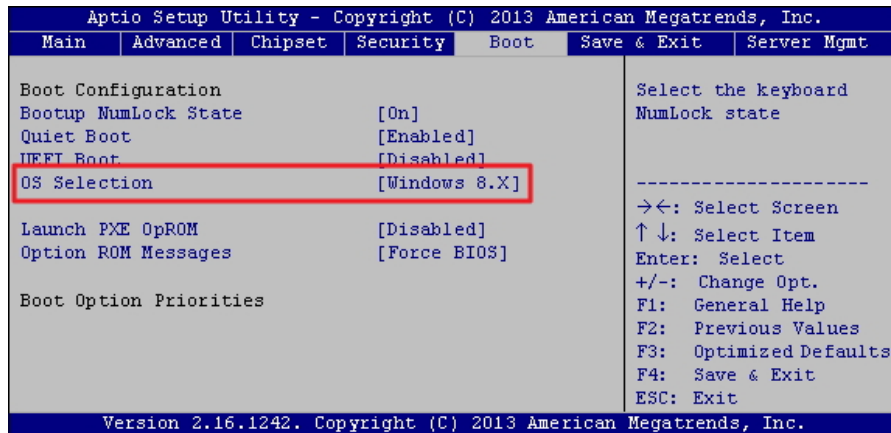

Figure 3-50: BIOS Option – OS Selection

3.18 Driver Installation

**NOTE:**

The content of the CD may vary throughout the life cycle of the product and is subject to change without prior notice. Visit the IEI website or contact technical support for the latest updates.

All the drivers for the PPC-F12B/15B/17B/19B-BTi are on the utility CD that came with the system. The utility CD contains drivers for Windows 7 and Windows 8 operating systems. Please select the corresponding drivers for the system.

The following drivers can be installed on the **Windows 7** operating system:

- Chipset
- I/O driver
- Graphics (Intel® EMGD)
- TXE
- USB 3.0
- LAN
- Audio
- Keypad AP

The following drivers can be installed on the **Windows 8** operating system:

- Chipset
- Serial I/O driver (64-bit only)
- TXE
- Graphics
- LAN
- Audio
- Keypad AP

3.18.1 Keypad AP

Keypad AP is an OSD control tool developed by IEI. After the installation, the Keypad AP can be accessed by clicking the  icon on the notification area. It allows users to control screen brightness and audio volume.



Figure 3-51: Keypad AP

3.19 IPMI Setup Procedure

The PPC-F12B/15B/17B/19B-BTi features Intelligent Platform Management Interface (IPMI) that helps lower the overall costs of server management by enabling users to maximize IT resources, save time and manage multiple systems. The PPC-F12B/15B/17B/19B-BTi supports IPMI 2.0 through the optional iRIS-2400 module. Follow the steps below to setup IPMI.

3.19.1 Managed System Hardware Setup

The hardware configuration of the managed system (PPC-F12B/15B/17B/19B-BTi) is described below.

- Step 1:** Install an iRIS-2400 module to the iRIS-2400 module slot (refer to **Section 3.9**).
- Step 2:** Make sure at least one DDR3L SO-DIMM is installed in one of the SO-DIMM sockets. If multiple SO-DIMMs are installed, all of the SO-DIMMs must be same size, same speed and same brand to get the best performance.
- Step 3:** Connect an Ethernet cable to the RJ-45 LAN port with **iRIS** label (**Figure 1-5**).

PPC-F12B/15B/17B/19B-BTi Panel PC

3.19.2 Using the IEI iMAN Web GUI

To manage a client system from a remote console using IEI iMAN Web GUI, follow the steps below.

- Step 1:** Obtain the IP address of the managed system. It is recommended to use the IPMI Tool on the managed system to obtain the IP address. To use IPMI Tool to obtain IP address, follow the steps below:
- Copy the **ipmitool.exe** file to a bootable USB flash drive.
 - Insert the USB flash drive to the PPC-F12B/15B/17B/19B-BTi
 - The PPC-F12B/15B/17B/19B-BTi boots from the USB flash drive
 - Enter the following command: **ipmitool 20 30 02 01 03 00 00**
(there is a space between each two-digit number)
 - A serial of number shows. The last four two-digit hexadecimal numbers are the IP address. Convert the hexadecimal numbers to decimal numbers.
- Step 2:** On the remote management console, open a web browser. Enter the managed system IP address in the web browser (**Figure 3-52**).

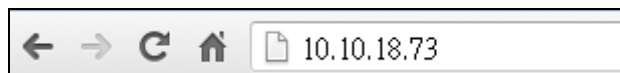

Figure 3-52: IEI iMAN Web Address

- Step 3:** The login page appears in the web browser.
- Step 4:** Enter the user name and password to login the system. The default login username and password are:
- Username: **admin**
 - Password: **admin**
- Step 5:** Press the login button to login the system.
- Step 6:** The IEI iMAN Web Interface appears.

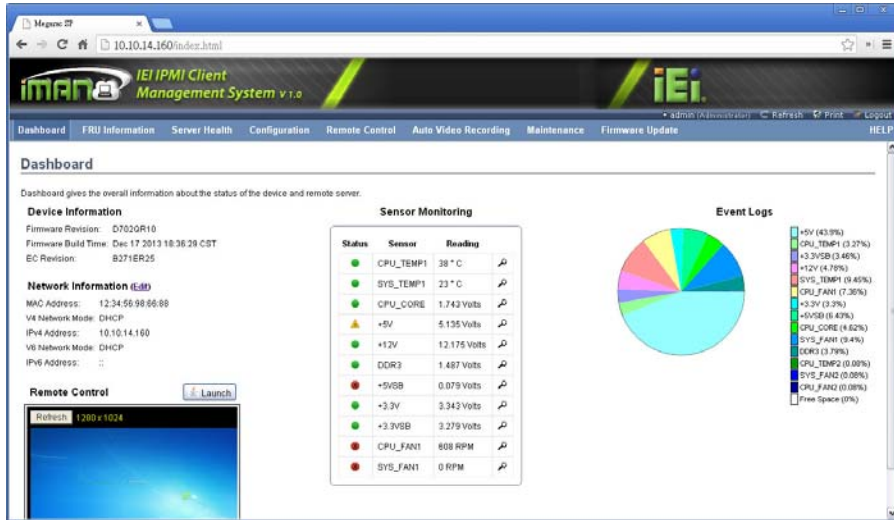

Figure 3-53: IEI iMAN Web GUI



NOTE:

To understand how to use the IEI iMAN Web GUI, please refer to the iRIS-2400 Web GUI user manual in the utility CD came with the PPC-F12B/15B/17B/19B-BTi. The user manual describes each function in detail.

Chapter

4

System Maintenance

4.1 System Maintenance Introduction

The following system components may require maintenance.

- Motherboard
- Memory module

If these components fail, they must be replaced. Please contact the system reseller or vendor to purchase replacement parts. Replacement instructions for the above listed components are described below.

4.2 Motherboard Replacement

A user cannot replace a motherboard. If the motherboard fails it must be shipped back to IEI to be replaced. If the system motherboard has failed, please contact the system vendor, reseller or an IEI sales person directly.

Chapter

5

BIOS Setup

5.1 Introduction

The BIOS is programmed onto the BIOS chip. The BIOS setup program allows changes to certain system settings. This chapter outlines the options that can be changed.



NOTE:

Some of the BIOS options may vary throughout the life cycle of the product and are subject to change without prior notice.

5.1.1 Starting Setup

The UEFI BIOS is activated when the computer is turned on. The setup program can be activated in one of two ways.

1. Press the **DELETE** or **F2** key as soon as the system is turned on or
2. Press the **DELETE** or **F2** key when the “**Press DELETE or F2 to enter SETUP**” message appears on the screen.

If the message disappears before the **DELETE** or **F2** key is pressed, restart the computer and try again.

5.1.2 Using Setup

Use the arrow keys to highlight items, press **ENTER** to select, use the PageUp and PageDown keys to change entries, press **F1** for help and press **ESC** to quit. Navigation keys are shown in the following table.

Key	Function
Up arrow	Move to the item above
Down arrow	Move to the item below
Left arrow	Move to the item on the left hand side
Right arrow	Move to the item on the right hand side
+	Increase the numeric value or make changes

PPC-F12B/15B/17B/19B-BTi Panel PC

Key	Function
-	Decrease the numeric value or make changes
Page up	Move to the next page
Page down	Move to the previous page
Esc	Main Menu – Quit and do not save changes into CMOS Status Page Setup Menu and Option Page Setup Menu -- Exit current page and return to Main Menu
F1	General help, only for Status Page Setup Menu and Option Page Setup Menu
F2	Load previous values
F3	Load optimized defaults
F4	Save changes and Exit BIOS

Table 5-1: BIOS Navigation Keys

5.1.3 Getting Help

When **F1** is pressed a small help window describing the appropriate keys to use and the possible selections for the highlighted item appears. To exit the Help Window press **Esc** or the **F1** key again.

5.1.4 Unable to Reboot after Configuration Changes

If the computer cannot boot after changes to the system configuration are made, press the Clear CMOS button on the bottom panel to clear the CMOS data and reset the system BIOS information. The location of the CMOS button is shown in **Figure 3-49**.

5.1.5 BIOS Menu Bar

The **menu bar** on top of the BIOS screen has the following main items:

- Main – Changes the basic system configuration.
- Advanced – Changes the advanced system settings.
- Chipset – Changes the chipset settings.
- Boot – Changes the system boot configuration.

- Security – Sets User and Supervisor Passwords.
- Save & Exit – Selects exit options and loads default settings

The following sections completely describe the configuration options found in the menu items at the top of the BIOS screen and listed above.

5.2 Main

The **Main** BIOS menu (**BIOS Menu 1**) appears when the **BIOS Setup** program is entered.

The **Main** menu gives an overview of the basic system information.

Aptio Setup Utility - Copyright (C) 2013 American Megatrends, Inc.						
Main	Advanced	Chipset	Security	Boot	Save & Exit	Server Mgmt
BIOS Information						Set the Date. Use Tab to switch between Data elements.
BIOS Vendor			American Megatrends			
Core Version			5.009			
Compliance			UEFI 2.3; PI 1.2			
Project Version			H796AM12.ROM			
Build Date and Time			12/03/2015 13:50:13			
iWDD Vendor			iEi			
iWDD Version			H796ER11.bin			
IPMI Module			N/A			
CPU Configuration						
Microcode Patch			809			-----
BayTrail SoC			C0 Stepping			→←: Select Screen
Memory Information						↑ ↓: Select Item
Total Memory			4096 MB (LPDDR3)			Enter: Select
TXE Information						+/-: Change Opt.
Sec RC Version			00.05.00.00			F1: General Help
TXE FW Version			01.00.02.1060			F2: Previous Values
System Date			[Fri 08/08/2014]			F3: Optimized Defaults
System Time			[15:10:27]			F4: Save & Exit
Access Level			Administrator			ESC: Exit
Version 2.16.1242. Copyright (C) 2013 American Megatrends, Inc.						

BIOS Menu 1: Main

PPC-F12B/15B/17B/19B-BTi Panel PC

The **Main** menu has two user configurable fields:

→ **System Date [xx/xx/xx]**

Use the **System Date** option to set the system date. Manually enter the day, month and year.

→ **System Time [xx:xx:xx]**

Use the **System Time** option to set the system time. Manually enter the hours, minutes and seconds.

5.3 Advanced

Use the **Advanced** menu (**BIOS Menu 2**) to configure the CPU and peripheral devices through the following sub-menus:



WARNING!

Setting the wrong values in the sections below may cause the system to malfunction. Make sure that the settings made are compatible with the hardware.

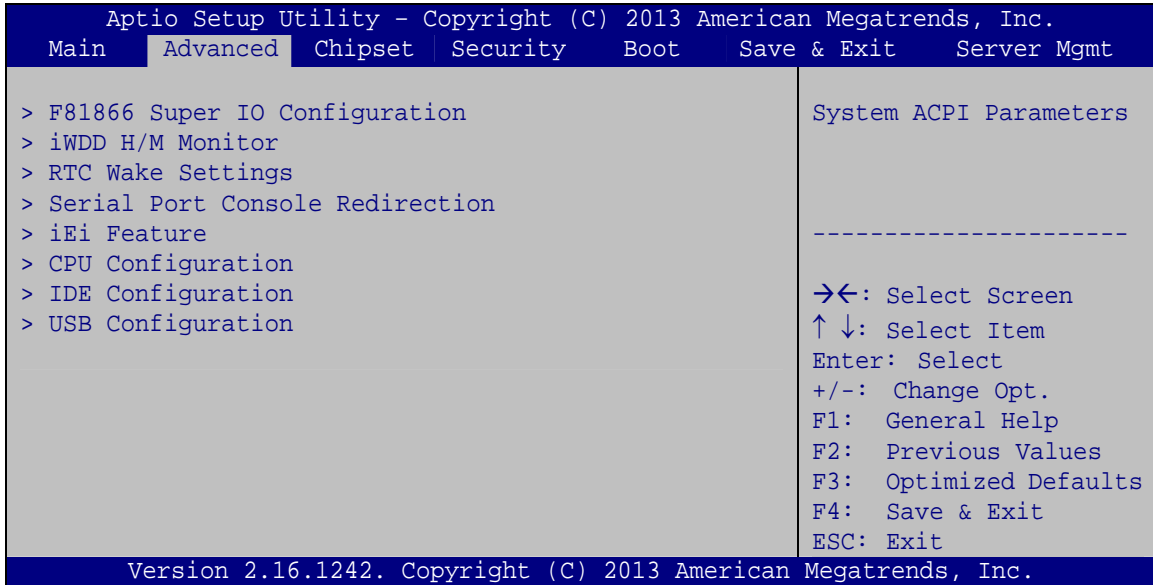

BIOS Menu 2: Advanced

5.3.1 F81866 Super IO Configuration

Use the **F81866 Super IO Configuration** menu (**BIOS Menu 3**) to set or change the configurations for the serial ports.

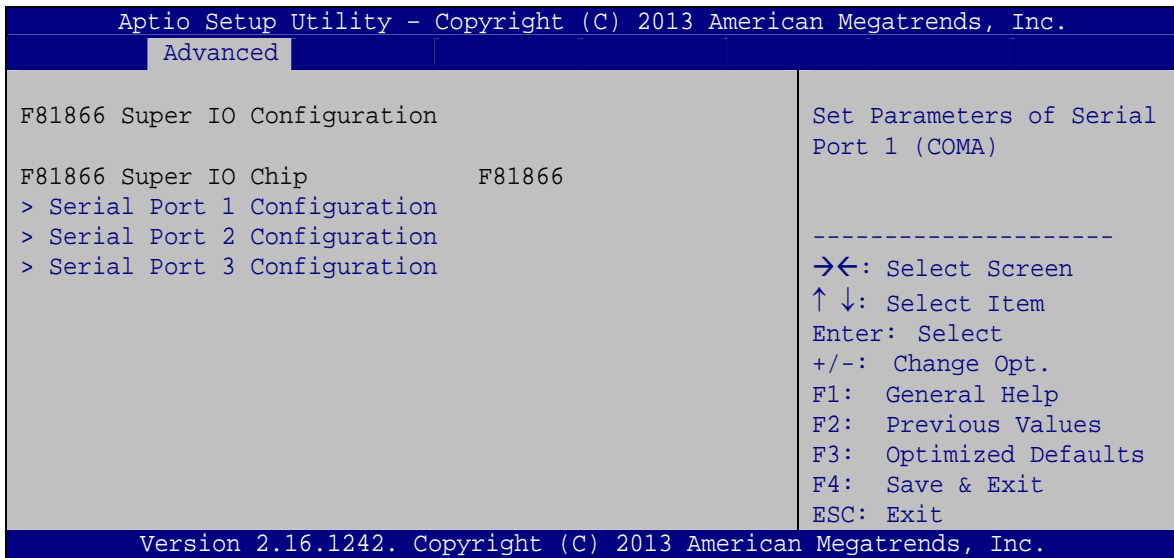

BIOS Menu 3: F81866 Super IO Configuration

PPC-F12B/15B/17B/19B-BTi Panel PC

5.3.1.1 Serial Port n Configuration

Use the **Serial Port n Configuration** menu (**BIOS Menu 4**) to configure the serial port n.

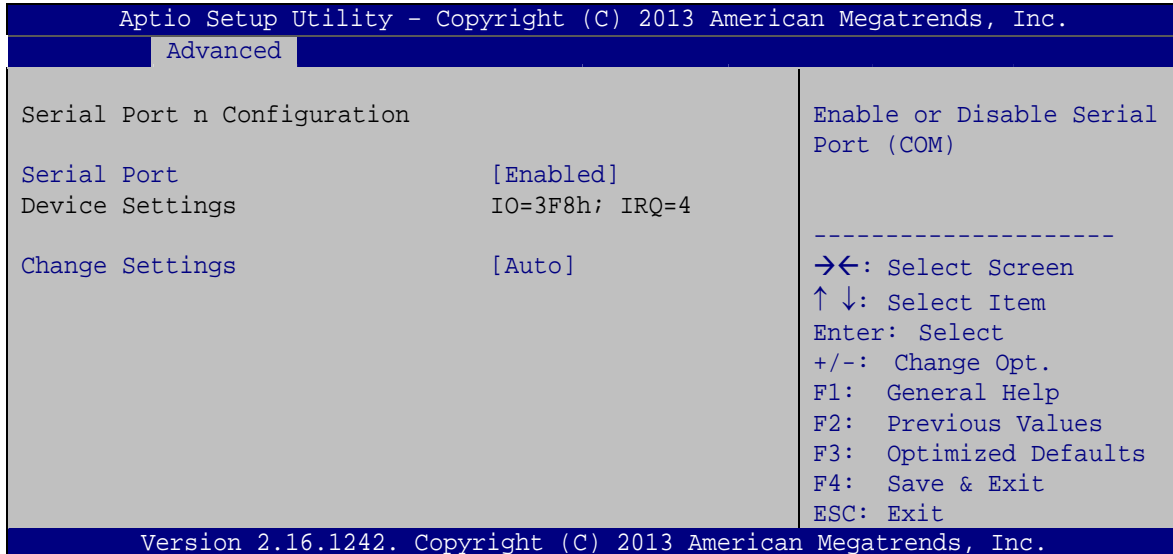

BIOS Menu 4: Serial Port n Configuration Menu

5.3.1.1.1 Serial Port 1 Configuration

→ Serial Port [Enabled]

Use the **Serial Port** option to enable or disable the serial port.

- **Disabled** Disable the serial port
- **Enabled** **DEFAULT** Enable the serial port

→ Change Settings [Auto]

Use the **Change Settings** option to change the serial port IO port address and interrupt address.

- **Auto** **DEFAULT** The serial port IO port address and interrupt address are automatically detected.
- **IO=3F8h;**
IRQ=4 Serial Port I/O port address is 3F8h and the interrupt address is IRQ4

- **IO=3F8h;**
IRQ=3, 4 Serial Port I/O port address is 3F8h and the interrupt address is IRQ3, 4
- **IO=2F8h;**
IRQ=3, 4 Serial Port I/O port address is 2F8h and the interrupt address is IRQ3, 4
- **IO=3E8h;**
IRQ=3, 4 Serial Port I/O port address is 3E8h and the interrupt address is IRQ3, 4
- **IO=2E8h;**
IRQ=3, 4 Serial Port I/O port address is 2E8h and the interrupt address is IRQ3, 4

5.3.1.1.2 Serial Port 2 Configuration

→ **Serial Port [Enabled]**

Use the **Serial Port** option to enable or disable the serial port.

- **Disabled** Disable the serial port
- **Enabled** **DEFAULT** Enable the serial port

→ **Change Settings [Auto]**

Use the **Change Settings** option to change the serial port IO port address and interrupt address.

- **Auto** **DEFAULT** The serial port IO port address and interrupt address are automatically detected.
- **IO=2F8h;**
IRQ=3 Serial Port I/O port address is 2F8h and the interrupt address is IRQ3
- **IO=3F8h;**
IRQ=3, 4 Serial Port I/O port address is 3F8h and the interrupt address is IRQ3, 4
- **IO=2E8h;**
IRQ=3, 4 Serial Port I/O port address is 2E8h and the interrupt address is IRQ3, 4
- **IO=3E8h;**
IRQ=3, 4 Serial Port I/O port address is 3E8h and the interrupt address is IRQ3, 4

➔ **Serial Port Mode [RS232]**

The **Serial Port Mode** option is used to set the Serial Port 3 signaling mode.

- ➔ **RS232** **DEFAULT** Enables serial port RS-232 support.
- ➔ **RS422** Enables serial port RS-422 support.
- ➔ **RS485** Enables serial port RS-485 support.

5.3.2 iWDD H/W Monitor

The iWDD H/W Monitor menu (**BIOS Menu 5**) displays operating temperature and fan speeds.

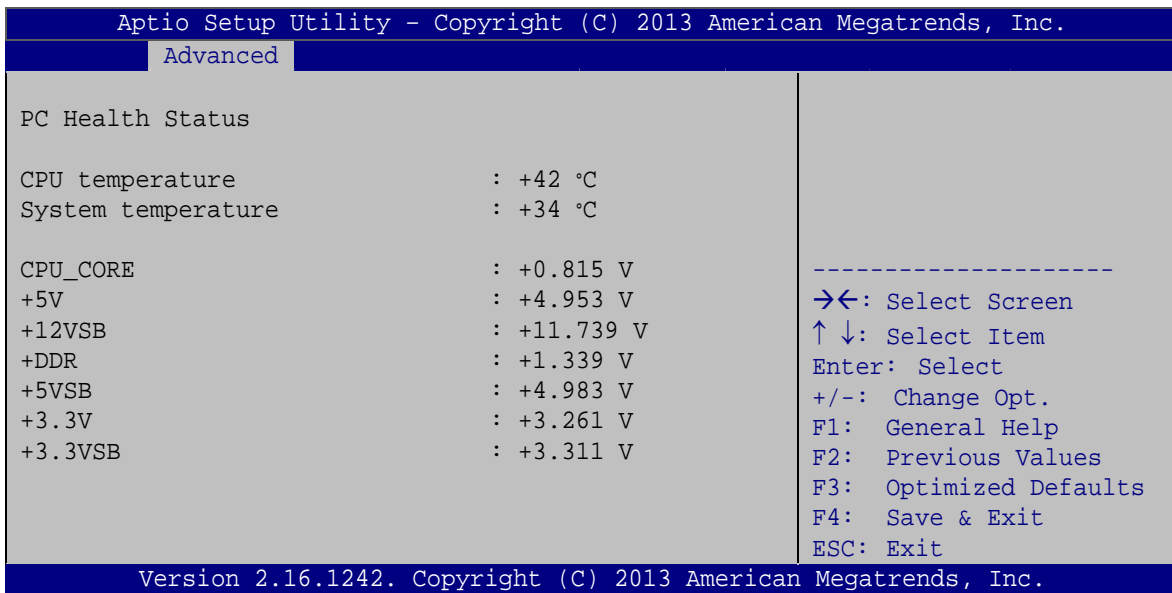

BIOS Menu 5: iWDD H/W Monitor

➔ **PC Health Status**

The following system parameters and values are shown. The system parameters that are monitored are:

- System Temperatures:
 - CPU Temperature

PPC-F12B/15B/17B/19B-BTi Panel PC

- System Temperature
- Voltages:
 - CPU_CORE
 - +5V
 - +12VSB
 - +DDR
 - +5VSB
 - +3.3V
 - +3.3VSB

5.3.3 RTC Wake Settings

The **RTC Wake Settings** menu (**BIOS Menu 6**) enables the system to wake at the specified time.

```

Aptio Setup Utility - Copyright (C) 2013 American Megatrends, Inc.
  Advanced
Wake system with Fixed Time      [Disabled]
                                     Enable or disable System
                                     wake on alarm event. When
                                     enabled, System will
                                     wake on the
                                     date::hr::min::sec
                                     specified
                                     -----
                                     →←: Select Screen
                                     ↑↓: Select Item
                                     Enter: Select
                                     +/-: Change Opt.
                                     F1: General Help
                                     F2: Previous Values
                                     F3: Optimized Defaults
                                     F4: Save & Exit
                                     ESC: Exit
Version 2.16.1242. Copyright (C) 2013 American Megatrends, Inc.

```

BIOS Menu 6: RTC Wake Settings

→ **Wake system with Fixed Time [Disabled]**

Use the **Wake system with Fixed Time** option to enable or disable the system wake on alarm event.

→ **Disabled** **DEFAULT** The real time clock (RTC) cannot generate a wake event

→ **Enabled** If selected, the **Wake up every day** option appears allowing you to enable to disable the system to wake every day at the specified time. Besides, the following options appear with values that can be selected:

Wake up date

Wake up hour

Wake up minute

Wake up second

After setting the alarm, the computer turns itself on from a suspend state when the alarm goes off.

5.3.4 Serial Port Console Redirection

The **Serial Port Console Redirection** menu (**BIOS Menu 7**) allows the console redirection options to be configured. Console redirection allows users to maintain a system remotely by re-directing keyboard input and text output through the serial port.

PPC-F12B/15B/17B/19B-BTi Panel PC

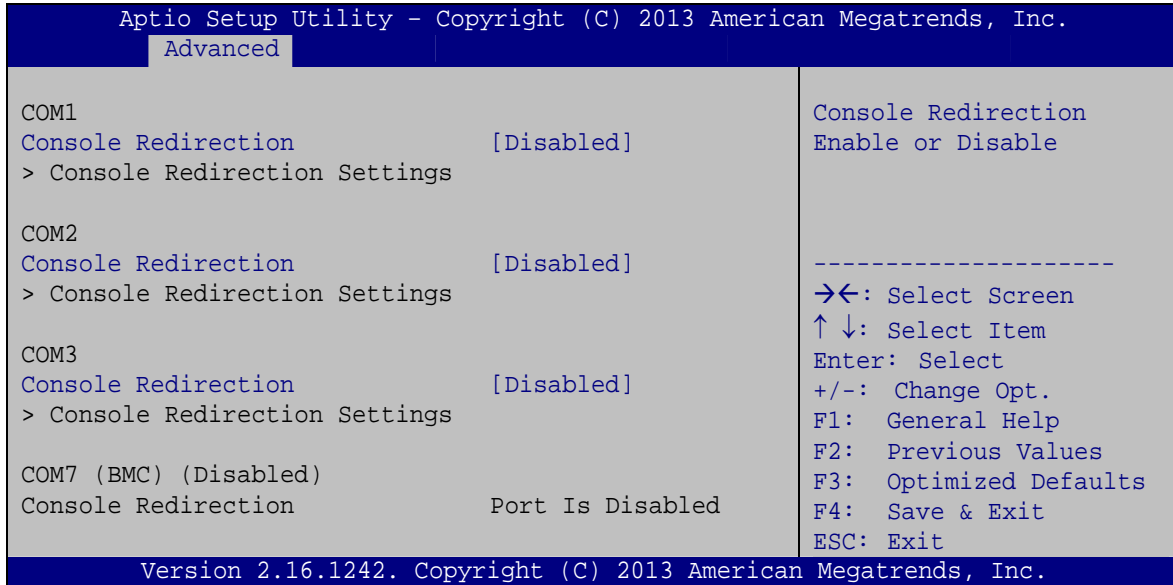

BIOS Menu 7: Serial Port Console Redirection

→ Console Redirection [Disabled]

Use **Console Redirection** option to enable or disable the console redirection function.

- **Disabled** **DEFAULT** Disabled the console redirection function
- **Enabled** Enabled the console redirection function

5.3.4.1 Console Redirection Settings

Use the **Console Redirection Settings** menu (**BIOS Menu 8**) to configure console redirection settings of the specified serial port. This menu appears only when the Console Redirection is enabled.

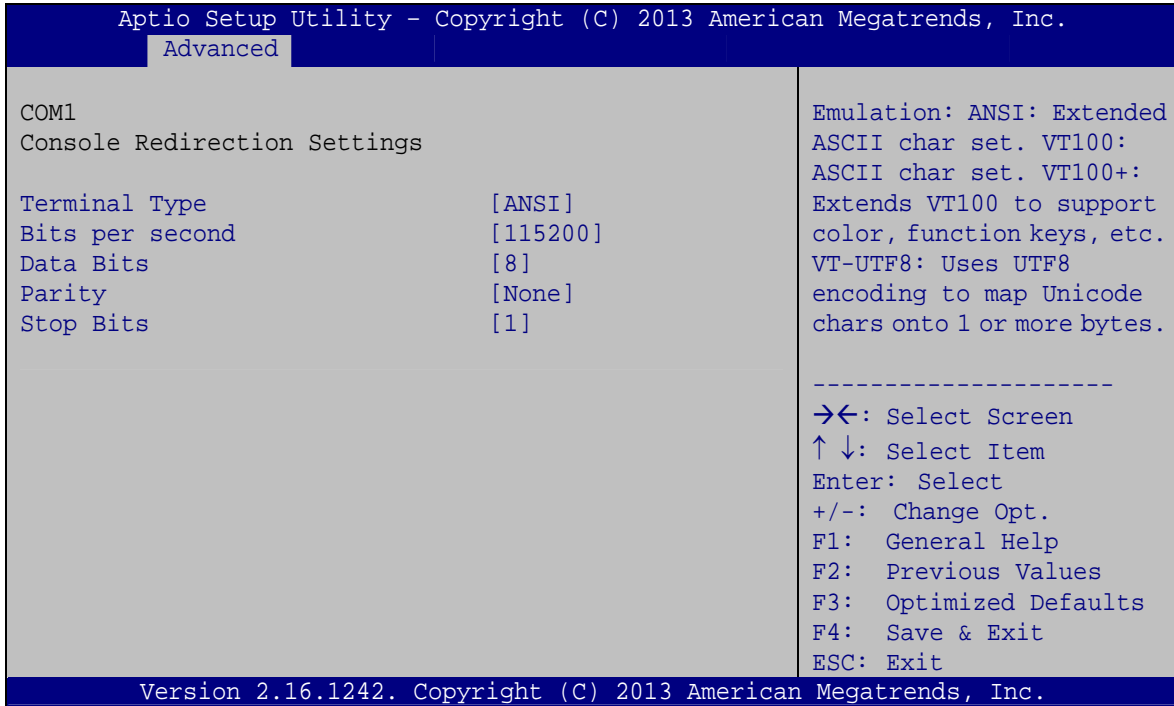

BIOS Menu 8: Console Redirection Settings

→ **Terminal Type [ANSI]**

Use the **Terminal Type** option to specify the remote terminal type.

- **VT100** The target terminal type is VT100
- **VT100+** The target terminal type is VT100+
- **VT-UTF8** The target terminal type is VT-UTF8
- **ANSI** **DEFAULT** The target terminal type is ANSI

→ **Bits per second [115200]**

Use the **Bits per second** option to specify the serial port transmission speed. The speed must match the other side. Long or noisy lines may require lower speeds.

- **9600** Sets the serial port transmission speed at 9600.
- **19200** Sets the serial port transmission speed at 19200.
- **38400** Sets the serial port transmission speed at 39400.
- **57600** Sets the serial port transmission speed at 57600.

PPC-F12B/15B/17B/19B-BTi Panel PC

→ 115200 **DEFAULT** Sets the serial port transmission speed at 115200.

→ **Data Bits [8]**

Use the **Data Bits** option to specify the number of data bits.

→ 7 Sets the data bits at 7.

→ 8 **DEFAULT** Sets the data bits at 8.

→ **Parity [None]**

Use the **Parity** option to specify the parity bit that can be sent with the data bits for detecting the transmission errors.

→ **None** **DEFAULT** No parity bit is sent with the data bits.

→ **Even** The parity bit is 0 if the number of ones in the data bits is even.

→ **Odd** The parity bit is 0 if the number of ones in the data bits is odd.

→ **Mark** The parity bit is always 1. This option does not provide error detection.

→ **Space** The parity bit is always 0. This option does not provide error detection.

→ **Stop Bits [1]**

Use the **Stop Bits** option to specify the number of stop bits used to indicate the end of a serial data packet. Communication with slow devices may require more than 1 stop bit.

→ 1 **DEFAULT** Sets the number of stop bits at 1.

→ 2 Sets the number of stop bits at 2.

5.3.5 iEi Feature

Use the **iEi Feature** menu (**BIOS Menu 9**) to configure One Key Recovery function.

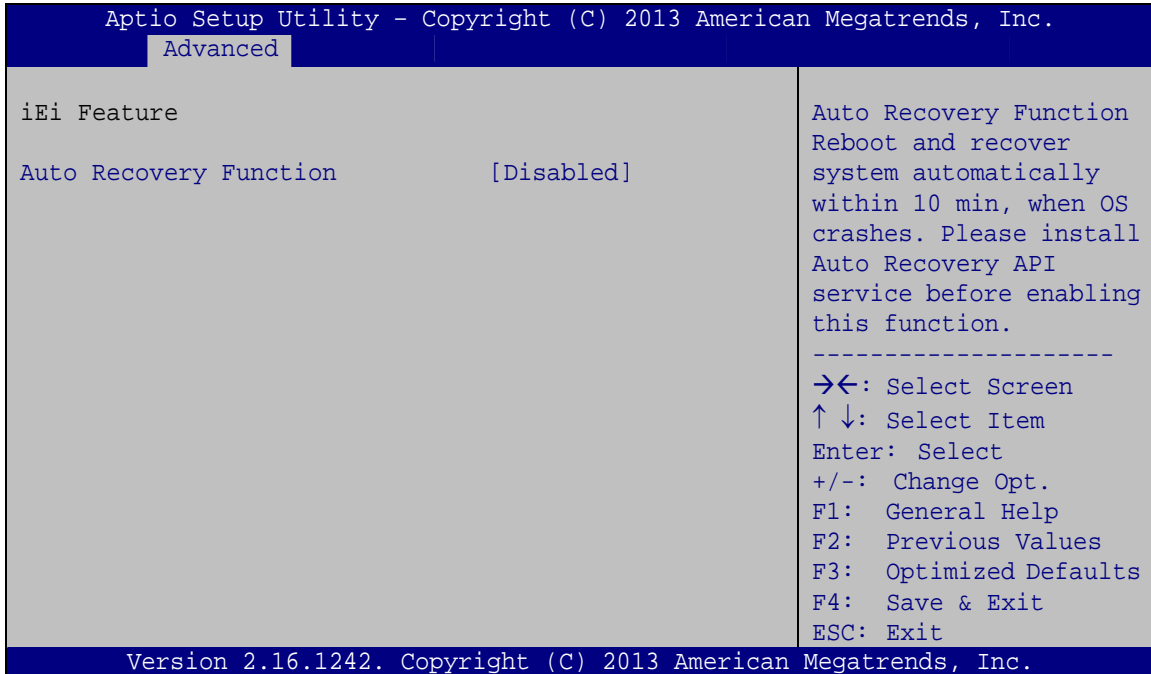

BIOS Menu 9: iEi Feature

→ Auto Recovery Function [Disabled]

Use the **Auto Recovery Function** BIOS option to enable or disable the auto recovery function of the IEI One Key Recovery.

- **Disabled** **DEFAULT** Auto recovery function disabled
- **Enabled** Auto recovery function enabled

PPC-F12B/15B/17B/19B-BTi Panel PC

5.3.6 CPU Configuration

Use the **CPU Configuration** menu (**BIOS Menu 10**) to view detailed CPU specifications and configure the CPU.

```

Aptio Setup Utility - Copyright (C) 2013 American Megatrends, Inc.
Advanced
CPU Configuration
Intel(R) Celeron(R) CPU J1900 @ 1.99GHz
CPU Signature          30678
Microcode Patch       809
Max CPU Speed         1990 MHz
Min CPU Speed         1334 MHz
Processor Cores       4
Intel HT Technology   Not Supported
Intel VT-x Technology Supported

L1 Data Cache        24 KB x 4
L1 Code Cache        32 KB x 4
L2 Cache             1024 KB x 2
L3 Cache             Not Present
64-bit               Supported

Intel Virtualization Technology [Enabled]
EIST                  [Enabled]

When enabled, a VMM can utilize the additional hardware capabilities provided by Vanderpool Technology

-----
-><: Select Screen
↑ ↓: Select Item
Enter: Select
+/-: Change Opt.
F1: General Help
F2: Previous Values
F3: Optimized Defaults
F4: Save & Exit
ESC: Exit

Version 2.16.1242. Copyright (C) 2013 American Megatrends, Inc.

```

BIOS Menu 10: CPU Configuration

The CPU Configuration menu (**BIOS Menu 10**) lists the following CPU details:

- CPU Signature: Lists the CPU signature value.
- Microcode Patch: Lists the microcode patch being used.
- Max CPU Speed: Lists the maximum CPU processing speed.
- Min CPU Speed: Lists the minimum CPU processing speed.
- Processor Cores: Lists the number of the processor core
- Intel HT Technology: Indicates if Intel HT Technology is supported by the CPU.
- Intel VT-x Technology: Indicates if Intel VT-x Technology is supported by the CPU.
- L1 Data Cache: Lists the amount of data storage space on the L1 cache.
- L1 Code Cache: Lists the amount of code storage space on the L1 cache.
- L2 Cache: Lists the amount of storage space on the L2 cache.

- L3 Cache: Lists the amount of storage space on the L3 cache.
- 64-bit: Indicates if 64-bit system is supported by the CPU.

→ **Intel Virtualization Technology [Enabled]**

Use the **Intel Virtualization Technology** option to enable or disable virtualization on the system. When combined with third party software, Intel® Virtualization technology allows several OSs to run on the same system at the same time.

- **Disabled** Disables Intel Virtualization Technology.
- **Enabled** **DEFAULT** Enables Intel Virtualization Technology.

→ **EIST [Enabled]**

Use the **EIST** option to enable or disable the Enhanced Intel® SpeedStep Technology (EIST).

- **Disabled** Disables Enhanced Intel® SpeedStep Technology
- **Enabled** **DEFAULT** Enables Enhanced Intel® SpeedStep Technology

PPC-F12B/15B/17B/19B-BTi Panel PC

5.3.7 IDE Configuration

Use the **IDE Configuration** menu (**BIOS Menu 11**) to change and/or set the configuration of the SATA devices installed in the system.

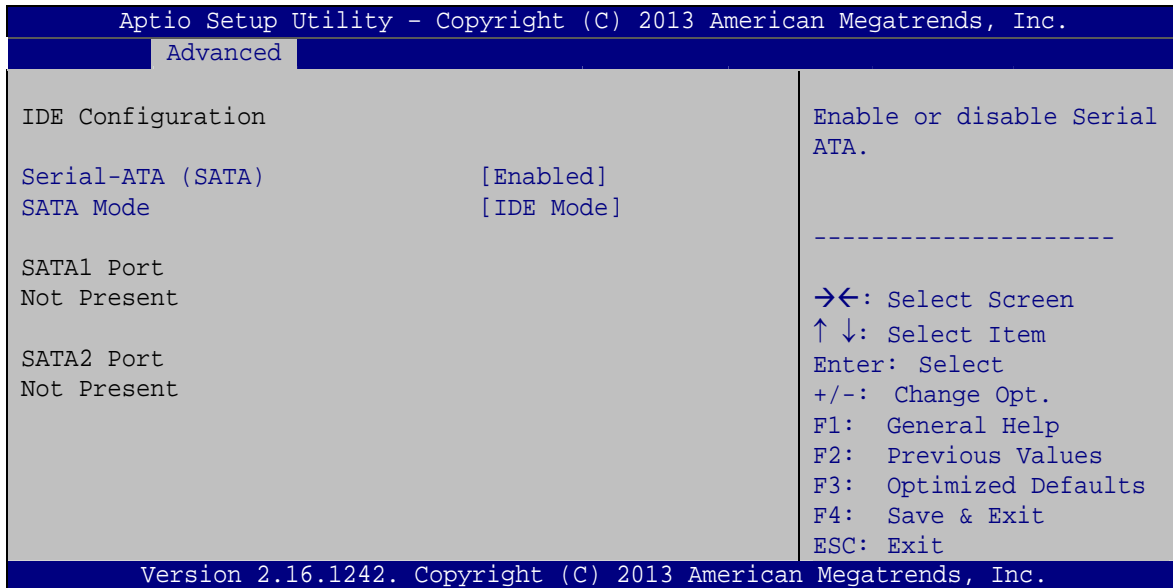

BIOS Menu 11: IDE Configuration

→ Serial-ATA (SATA) [Enabled]

Use the **Serial-ATA (SATA)** option to configure the SATA controller(s).

- **Enabled** **DEFAULT** Enables the on-board SATA controller(s).
- **Disabled** Disables the on-board SATA controller(s).

→ SATA Mode Selection [IDE Mode]

Use the **SATA Mode Selection** option to determine how SATA devices operate.

- **IDE Mode** **DEFAULT** Configures SATA devices as normal IDE device.
- **AHCI Mode** Configures SATA devices as AHCI device.

5.3.8 USB Configuration

Use the **USB Configuration** menu (**BIOS Menu 12**) to read USB configuration information and configure the USB settings.

```

Aptio Setup Utility - Copyright (C) 2013 American Megatrends, Inc.
  Advanced
-----
USB Configuration
USB Devices:
  1 Keyboard, 1 Mouse, 1 Point, 2 Hubs
Legacy USB Support          [Enabled]
-----
Enables Legacy USB
support. AUTO option
disables legacy support
if no USB devices are
connected. DISABLE
option will keep USB
devices available only
for EFI applications.

-----
-><: Select Screen
↑↓: Select Item
Enter: Select
+/-: Change Opt.
F1: General Help
F2: Previous Values
F3: Optimized Defaults
F4: Save & Exit
ESC: Exit

Version 2.16.1242. Copyright (C) 2013 American Megatrends, Inc.

```

BIOS Menu 12: USB Configuration

➔ USB Devices

The **USB Devices** field lists the USB devices that are enabled on the system

➔ Legacy USB Support [Enabled]

Use the **Legacy USB Support** BIOS option to enable USB mouse and USB keyboard support. Normally if this option is not enabled, any attached USB mouse or USB keyboard does not become available until a USB compatible operating system is fully booted with all USB drivers loaded. When this option is enabled, any attached USB mouse or USB keyboard can control the system even when there is no USB driver loaded onto the system.

➔ **Enabled** **DEFAULT** Legacy USB support enabled

PPC-F12B/15B/17B/19B-BTi Panel PC

- ➔ **Disabled** Legacy USB support disabled
- ➔ **Auto** Legacy USB support disabled if no USB devices are connected

5.4 Chipset

Use the **Chipset** menu (**BIOS Menu 13**) to access the PCH and System Agent (SA) configuration menus.



WARNING!

Setting the wrong values for the Chipset BIOS selections in the Chipset BIOS menu may cause the system to malfunction.

```

Aptio Setup Utility - Copyright (C) 2013 American Megatrends, Inc.
Main   Advanced  Chipset  Security  Boot   Save & Exit  Server Mgmt
-----
> North Bridge
> South Bridge

PCH Parameters
-----
-><: Select Screen
↑↓: Select Item
Enter: Select
+/-: Change Opt.
F1: General Help
F2: Previous Values
F3: Optimized Defaults
F4: Save & Exit
ESC: Exit

Version 2.16.1242. Copyright (C) 2013 American Megatrends, Inc.
    
```

BIOS Menu 13: Chipset

5.4.1 North Bridge

Use the **North Bridge** menu (**BIOS Menu 14**) to configure the north bridge parameters.

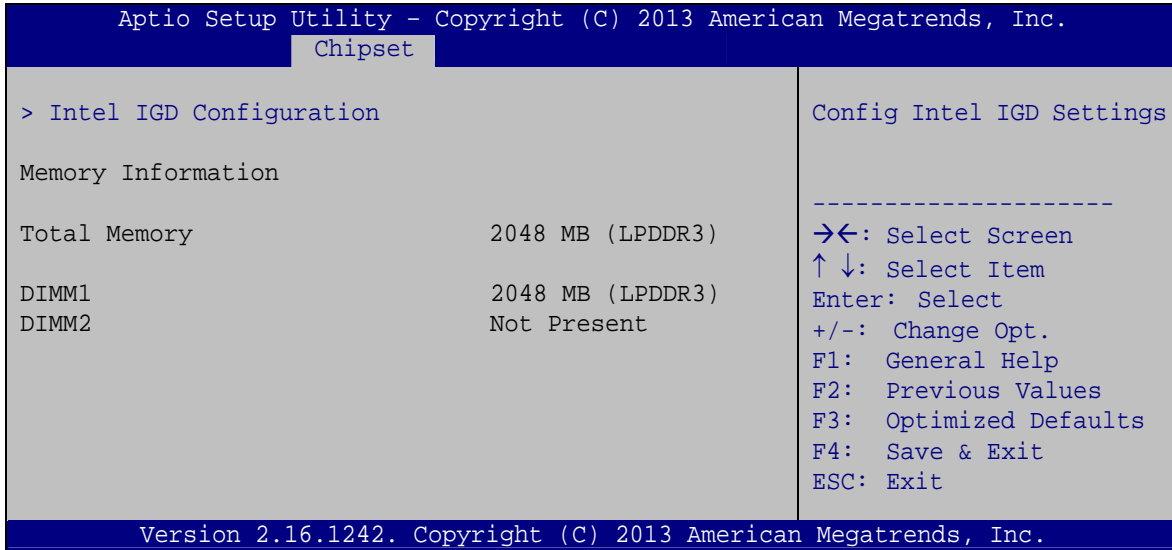

BIOS Menu 14: North Bridge

5.4.1.1 Intel IGD Configuration

Use the **Intel IGD Configuration** submenu (**BIOS Menu 15**) to configure the graphics settings.

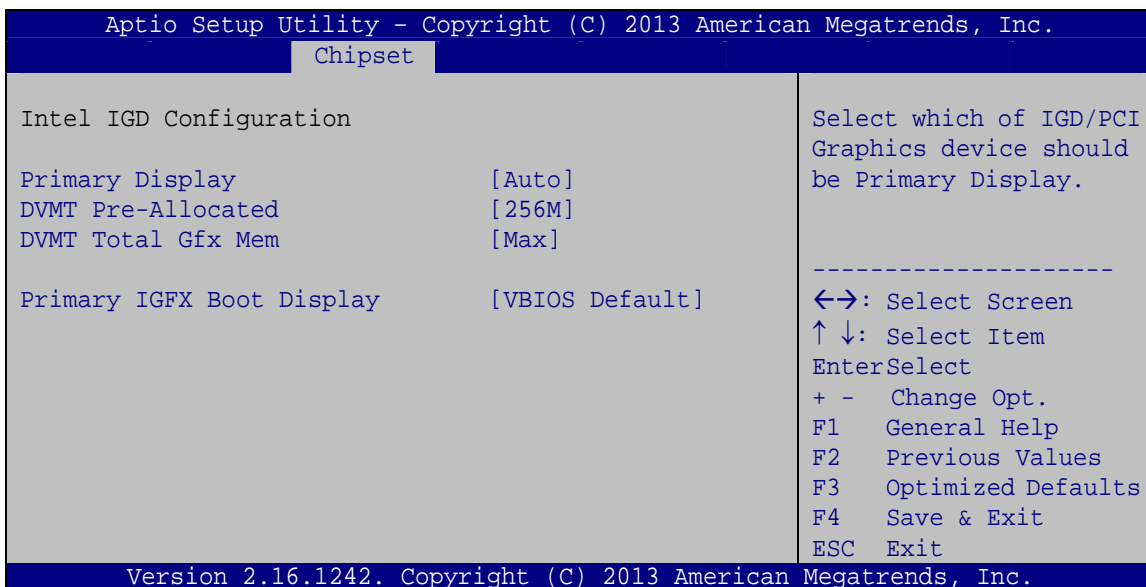

BIOS Menu 15: Intel IGD Configuration

PPC-F12B/15B/17B/19B-BTi Panel PC

→ Primary Display [Auto]

Use the **Primary Display** option to select the display device used by the system when it boots. Configuration options are listed below.

- Auto **DEFAULT**
- IGD
- PCIe

→ DVMT Pre-Allocated [256M]

Use the **DVMT Pre-Allocated** option to specify the amount of system memory that can be used by the internal graphics device.

- 64M 64 MB of memory used by internal graphics device
- 128M 128 MB of memory used by internal graphics device
- 256M **DEFAULT** 256 MB of memory used by internal graphics device
- 512M 512 MB of memory used by internal graphics device

→ DVMT Total Gfx Mem [Max]

Use the **DVMT Total Gfx Mem** option to specify the maximum amount of memory that can be allocated as graphics memory. Configuration options are listed below.

- 128MB
- 256MB
- Max **DEFAULT**

→ Primary IGFX Boot Display [VBIOS Default]

Use the **Primary IGFX Boot Display** option to select the display device used by the system when it boots. Configuration options are listed below.

- VBIOS Default **DEFAULT**

- CRT
- HDMI
- LVDS

5.4.2 South Bridge

Use the **South Bridge** menu (**BIOS Menu 16**) to configure the south bridge parameters.

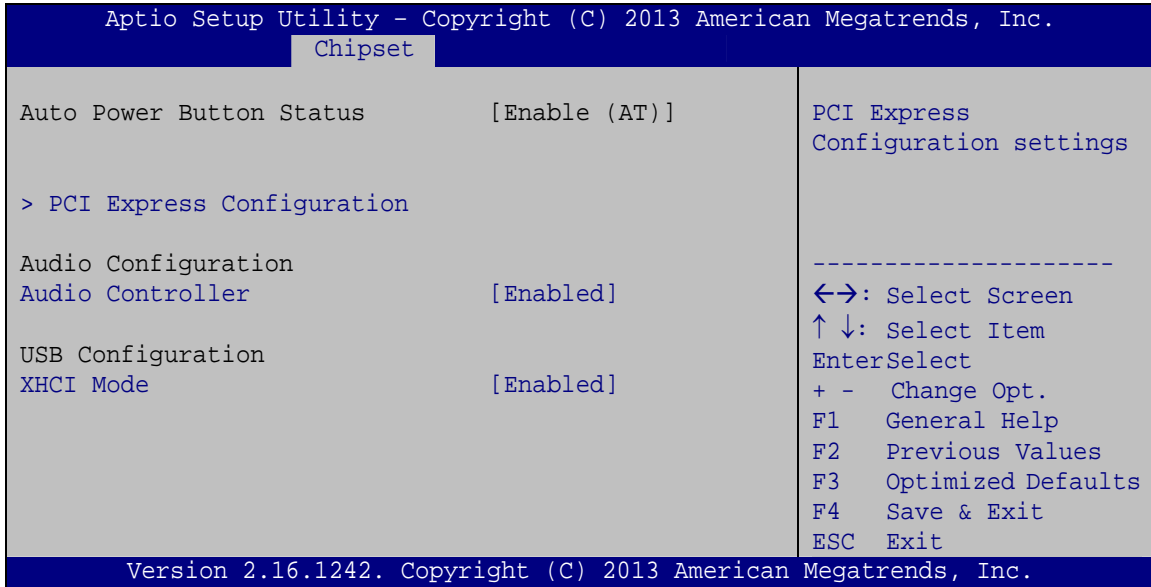

BIOS Menu 16: South Bridge

→ Auto Power Button Status [Enable (AT)]

This option can not be configured in the BIOS menu. It shows the power mode set by the AT/ATX mode switch on the bottom panel.

		AT/ATX Switch	
		AT (Default)	ATX
Power Switch Position	Off (O)	The system remains off.	The system remains off.
	On (I)	The system turns on once power is connected.	Depends on the state selected in the Restore AC Power Loss BIOS option (see below).

PPC-F12B/15B/17B/19B-BTi Panel PC

→ Restore AC Power Loss [Last State]

This option is available only when the system is set to ATX power mode using the AT/ATX mode switch on the bottom panel. Use the **Restore AC Power Loss** BIOS option to specify what state the system returns to if there is a sudden loss of power to the system.

- **Power Off** The system remains turned off. It needs to be triggered* to turn it on.
- **Power On** The system turns on.
- **Last State** **DEFAULT** The system returns to its previous state. If it was shut down normally, it needs to be triggered to turn it on. If it was shut down abnormally, it turns itself on without trigger.

*To trigger the system, short the **PWR_BTN1** connector. Please refer to **Section 0** and **Section 6.2.16**.

→ Audio Controller [Enabled]

Use the **Audio Controller** BIOS option to enable or disable the High Definition Audio controller.

- **Disabled** The High Definition Audio controller is disabled.
- **Enabled** **DEFAULT** The High Definition Audio controller is enabled.

→ XHCI Mode [Enabled]

Use the **XHCI Mode** BIOS option to configure the USB xHCI (USB 3.0) controller.

- **Enabled** **DEFAULT** Enable the xHCI controller. USB 3.0 ports behave as USB 3.0 ports.

5.4.2.1 PCI Express Configuration

Use the **PCI Express Configuration** submenu (**BIOS Menu 17**) to configure the PCI Express slots.

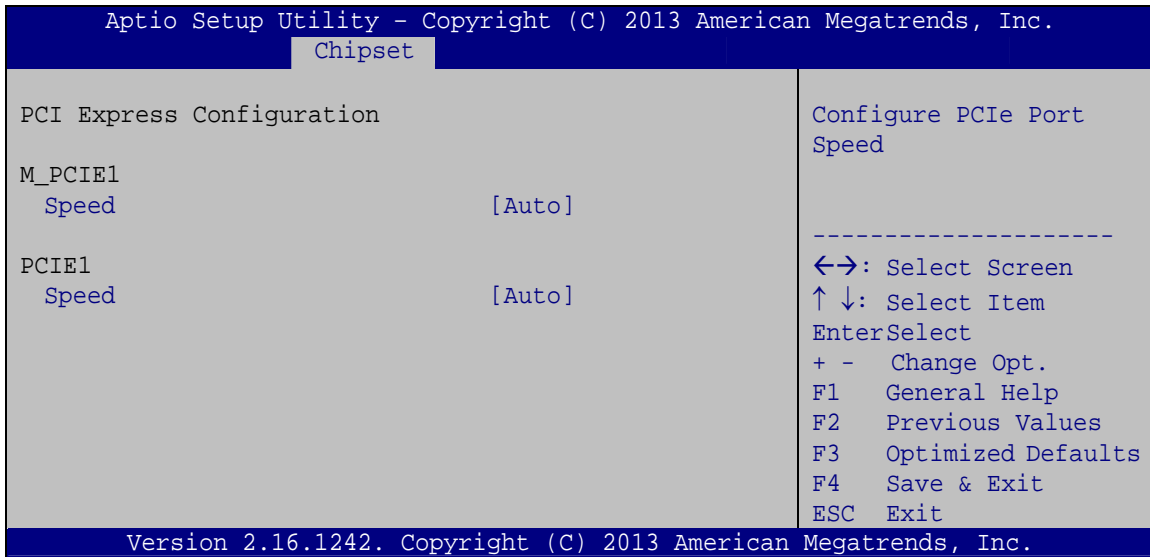

BIOS Menu 17: PCI Express Configuration

→ Speed [Auto]

Use the **Speed** option to configure the PCIe interface speed.

- Auto **DEFAULT**
- Gen 2
- Gen 1

PPC-F12B/15B/17B/19B-BTi Panel PC

5.5 Security

Use the **Security** menu (**BIOS Menu 18**) to set system and user passwords.

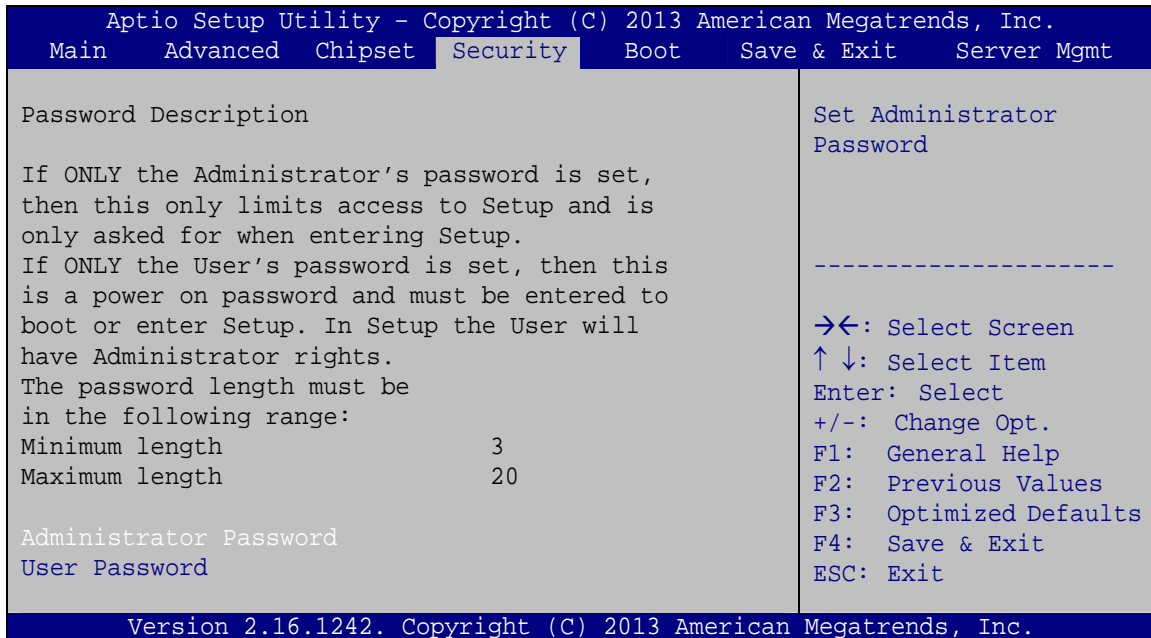
**BIOS Menu 18: Security**→ **Administrator Password**

Use the **Administrator Password** to set or change an administrator password.

→ **User Password**

Use the **User Password** to set or change a user password.

5.6 Boot

Use the **Boot** menu (**BIOS Menu 19**) to configure system boot options.

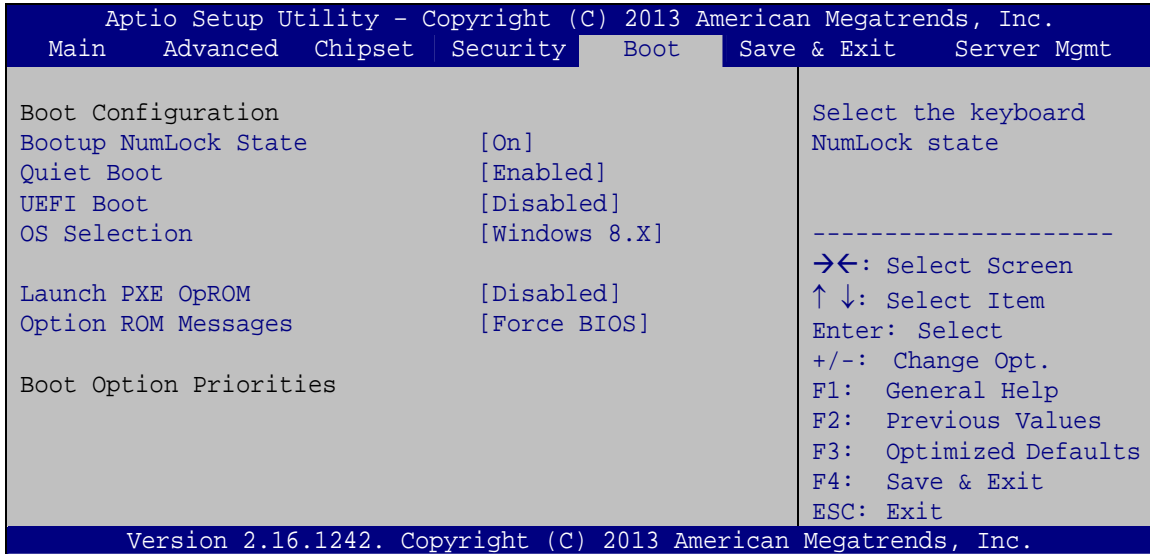

BIOS Menu 19: Boot

→ Bootup NumLock State [On]

Use the **Bootup NumLock State** BIOS option to specify if the number lock setting must be modified during boot up.

→ **On** **DEFAULT** Allows the Number Lock on the keyboard to be enabled automatically when the computer system boots up. This allows the immediate use of the 10-key numeric keypad located on the right side of the keyboard. To confirm this, the Number Lock LED light on the keyboard is lit.

→ **Off** Does not enable the keyboard Number Lock automatically. To use the 10-keys on the keyboard, press the Number Lock key located on the upper left-hand corner of the 10-key pad. The Number Lock LED on the keyboard lights up when the Number Lock is engaged.

PPC-F12B/15B/17B/19B-BTi Panel PC

→ Quiet Boot [Enabled]

Use the **Quiet Boot** BIOS option to select the screen display when the system boots.

- **Disabled** Normal POST messages displayed
- **Enabled** **DEFAULT** OEM Logo displayed instead of POST messages

→ UEFI Boot [Disabled]

Use the **UEFI Boot** option to enable or disable to boot from the UEFI devices.

- **Enabled** Boot from UEFI devices is enabled.
- **Disabled** **DEFAULT** Boot from UEFI devices is disabled.

→ OS Selection [Windows 8.x]

Use the **OS Selection** BIOS option to select an operating system (OS) before installing OS.

- **Windows 8.x** **DEFAULT** The system will be installed with Windows 8.x operating system.
- **Windows 7** The system will be installed with Windows 7 operating system.



WARNING:

Before installing the operating system, the user must enter the **Boot** BIOS menu and choose which operating system will be installed. Otherwise the USB 2.0 and USB 3.0 ports may not be detected.

➔ **Launch PXE OpROM [Disabled]**

Use the **Launch PXE OpROM** option to enable or disable boot option for legacy network devices.

- ➔ **Disabled** **DEFAULT** Ignore all PXE Option ROMs
- ➔ **Enabled** Load PXE Option ROMs

➔ **Option ROM Messages [Force BIOS]**

Use the **Option ROM Messages** option to set the Option ROM display mode.

- ➔ **Force BIOS** **DEFAULT** Sets display mode to force BIOS.
- ➔ **Keep Current** Sets display mode to current.

5.7 Save & Exit

Use the **Save & Exit** menu (**BIOS Menu 20**) to load default BIOS values, optimal failsafe values and to save configuration changes.

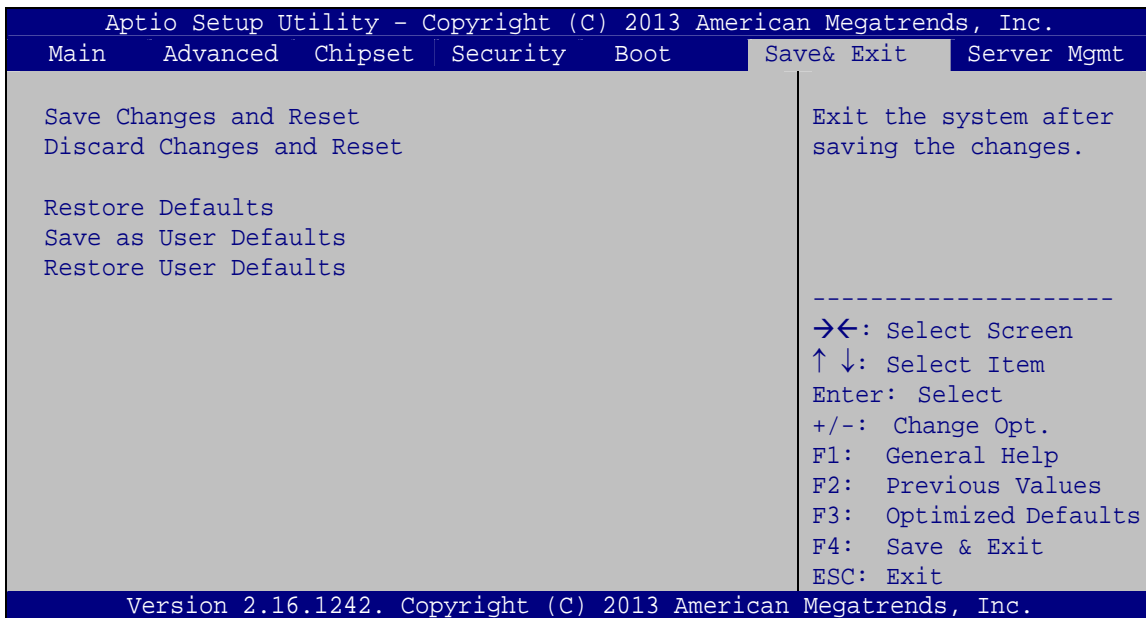

BIOS Menu 20: Save & Exit

PPC-F12B/15B/17B/19B-BTi Panel PC

→ **Save Changes and Reset**

Use the **Save Changes and Reset** option to save the changes made to the BIOS options and reset the system.

→ **Discard Changes and Reset**

Use the **Discard Changes and Reset** option to exit the system without saving the changes made to the BIOS configuration setup program.

→ **Restore Defaults**

Use the **Restore Defaults** option to load the optimal default values for each of the parameters on the Setup menus. **F3 key can be used for this operation.**

→ **Save as User Defaults**

Use the **Save as User Defaults** option to save the changes done so far as user defaults.

→ **Restore User Defaults**

Use the **Restore User Defaults** option to restore the user defaults to all the setup options.

5.8 Server Mgmt

Use the **Server Mgmt** menu (**BIOS Menu 21**) to configure system event log and BMC network parameters.

```

Aptio Setup Utility - Copyright (C) 2013 American Megatrends, Inc.
Main   Advanced  Chipset  Security  Boot   Save & Exit  Server Mgmt

BMC Self Test Status          FAILED
BMC Firmware Revision         Unknown
> System Event Log
> BMC network configuration

Configure BMC network
parameters

-----
-><: Select Screen
↑↓: Select Item
Enter: Select
+/-: Change Opt.
F1:  General Help
F2:  Previous Values
F3:  Optimized Defaults
F4:  Save & Exit
ESC: Exit

Version 2.16.1242. Copyright (C) 2013 American Megatrends, Inc.
    
```

BIOS Menu 21: Server Mgmt

PPC-F12B/15B/17B/19B-BTi Panel PC

5.8.1 System Event Log

Use the **System Event Log** menu (**BIOS Menu 22**) to configure system event log options.

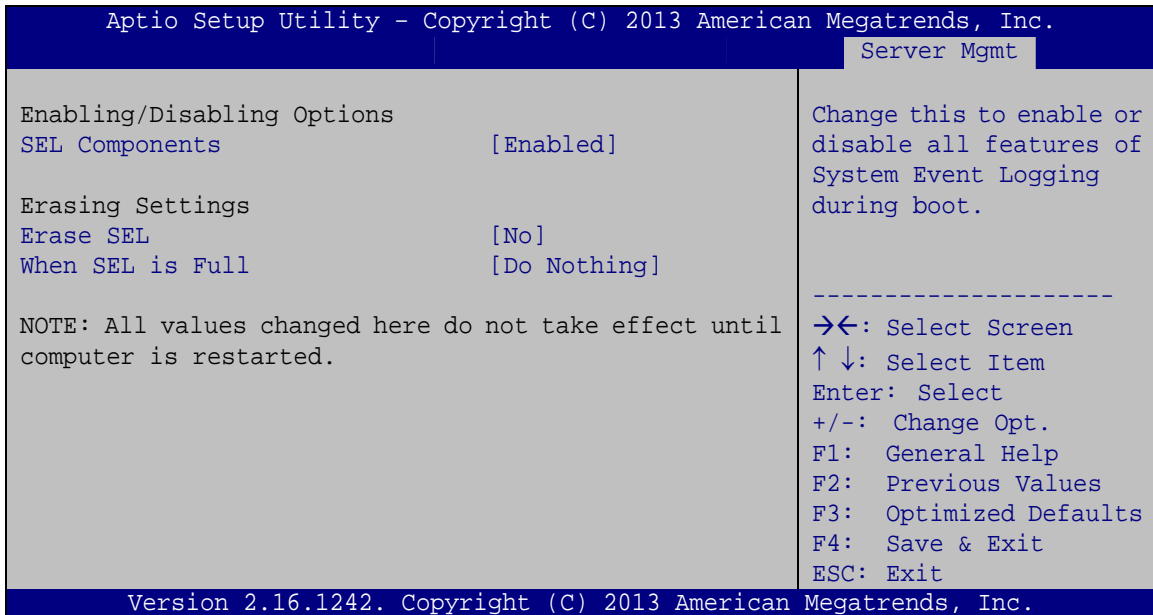

BIOS Menu 22: System Event Log

→ SEL Components [Enabled]

Use the **SEL Components** option to enable or disable all features of System Event Log during boot.

- **Disabled** System Event Log features disabled.
- **Enabled** **DEFAULT** System Event Log features enabled.

→ Erase SEL [No]

Use the **Erase SEL** option to select an option for erasing SEL (system event log).

- **No** **DEFAULT** Do not erase SEL
- **Yes,**
On next reset Erase SEL on next reset

- **Yes,** Erase SEL on every reset
On every reset

→ **When SEL is Full [Do Nothing]**

Use the **When SEL is Full** option to select an option for reaction to a full SEL.

- **Do Nothing** **DEFAULT** Do nothing when SEL is full
- **Erase**
Immediately Erase SEL immediately when SEL is full

5.8.2 BMC Network Configuration

Use the **BMC Network Configuration** menu (**BIOS Menu 23**) to configure BMC network parameters.

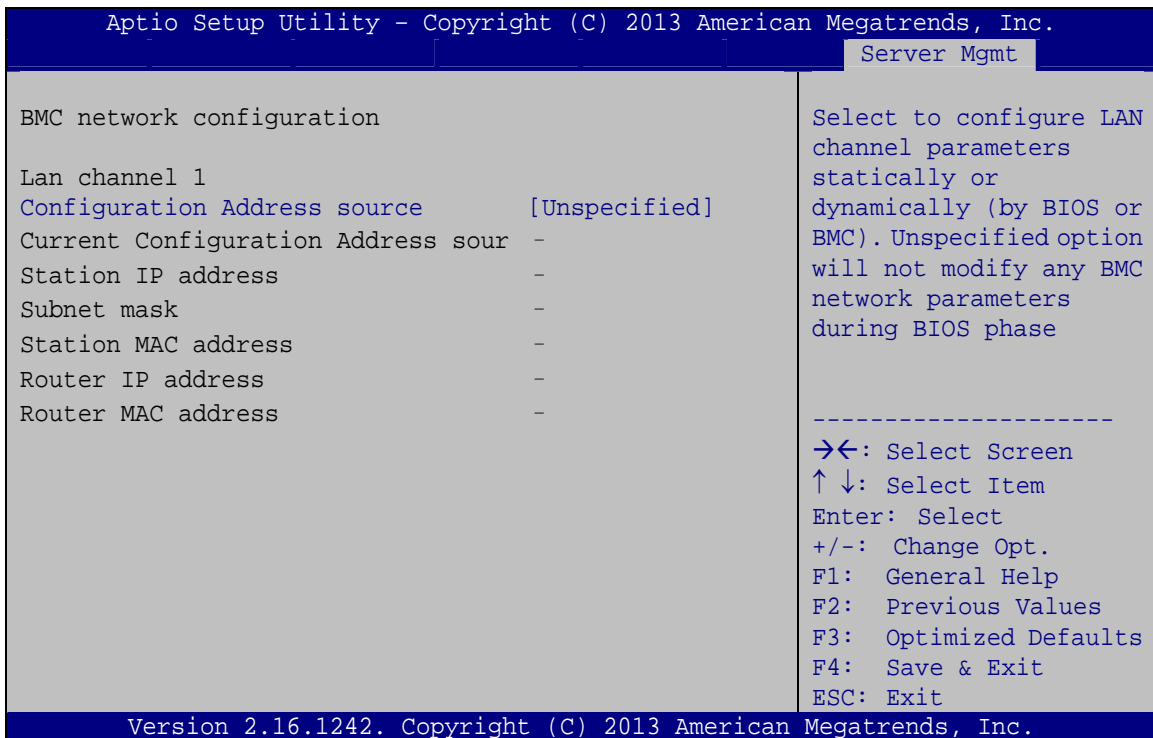

BIOS Menu 23: System Event Log

PPC-F12B/15B/17B/19B-BTi Panel PC**→ Configuration Address source [Unspecified]**

Use the **Configuration Address source** to configure LAN channel parameters statically or dynamically (by BIOS or BMC).

- | | | |
|----------------------------|----------------|--|
| → Unspecified | DEFAULT | BMC network parameters will not be modified during BIOS phase. |
| → Static | | Select to modify the following BMC network parameters: <ul style="list-style-type: none">▪ Station IP address▪ Subnet mask▪ Router IP address▪ Router MAC address |
| → DynamicBmcDhcp | | Select to configure LAN channel parameters dynamically by BMC running DHCP |
| → DynamicBmcNonDhcp | | Select to configure LAN channel parameters dynamically by BMC running other address assignment protocol |

Chapter

6

Interface Connectors

PPC-F12B/15B/17B/19B-BTi Panel PC

6.1 Peripheral Interface Connectors

The PPC-F12B/15B/17B/19B-BTi panel PC motherboard comes with a number of peripheral interface connectors and configuration jumpers. The connector locations are shown in **Figure 6-1** and **Figure 6-2**. The Pin 1 locations of the on-board connectors are also indicated in the diagrams. The connector pinouts for these connectors are listed in the following sections.

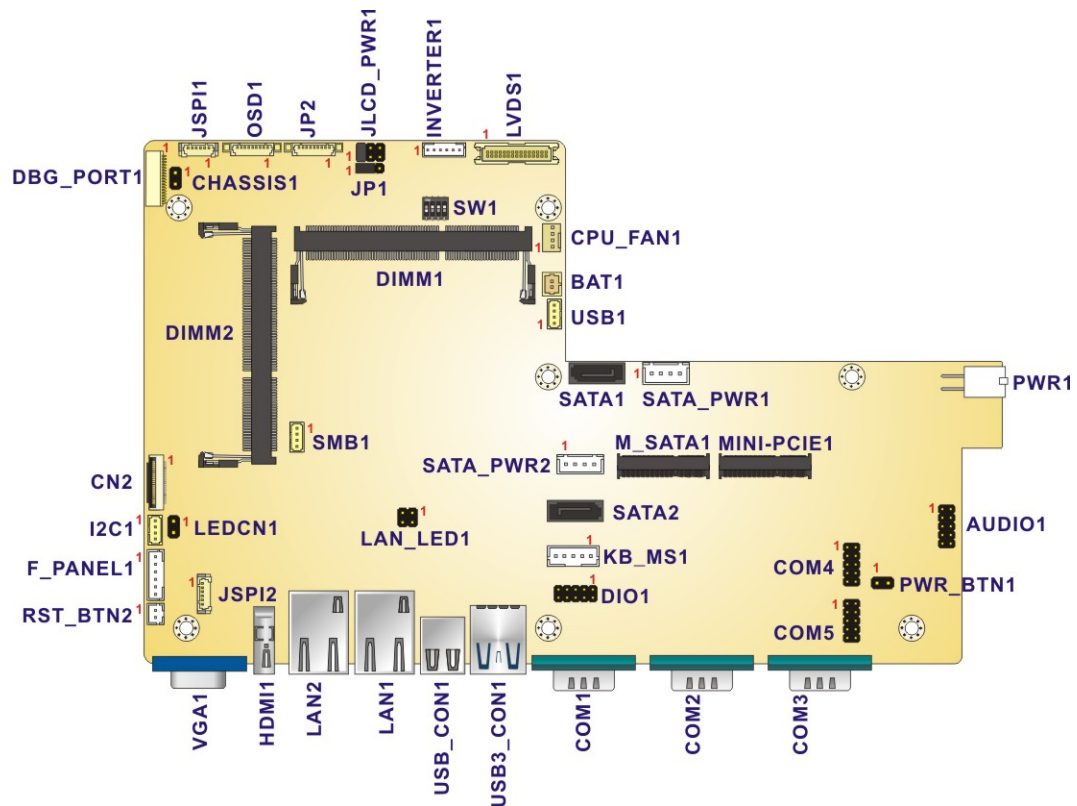

Figure 6-1: Main Board Layout Diagram (Front Side)

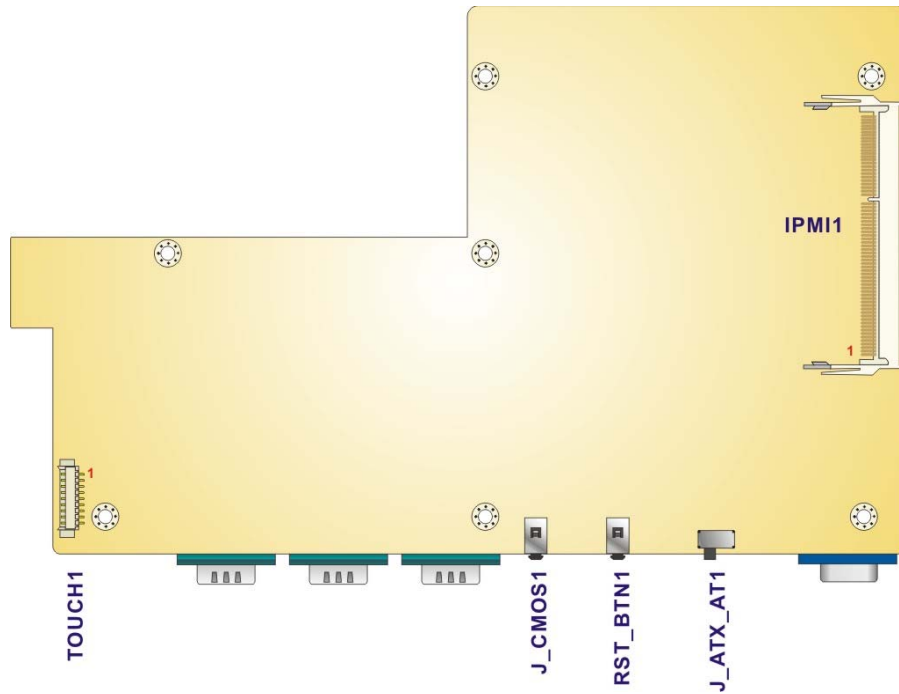

Figure 6-2: Main Board Layout Diagram (Solder Side)

6.2 Internal Peripheral Connectors

Internal peripheral connectors are found on the motherboard and are only accessible when the motherboard is outside of the chassis. The table below shows a list of the peripheral interface connectors on the PPC-F12B/15B/17B/19B-BTi motherboard. Pinouts of these connectors can be found in the following sections.

Connector	Type	Label
Audio connector	10-pin header	AUDIO1
Chassis intrusion connector	2-pin header	CHASSIS1
Debug port	12-pin wafer	DBG_PORT1
DIO connector	10-pin header	DIO1
EC debug port	18-pin wafer	CN2
Fan connector (CPU)	4-pin wafer	CPU_FAN1
Front panel connector	6-pin wafer	F_PANEL1

PPC-F12B/15B/17B/19B-BTi Panel PC

Connector	Type	Label
I ² C connector	4-pin wafer	I2C1
IPMI active LED connector	2-pin header	LEDCN1
iRIS module slot	iRIS-2400 slot	IPMI1
Keyboard and mouse connector	6-pin wafer	KB_MS1
Keypad connector (for RD test)	9-pin wafer	OSD1
LAN active LED connectors	2-pin header	LAN_LED1
LVDS connector	30-pin crimp	LVDS1
LVDS backlight connector	6-pin wafer	INVERTER1
PCIe Mini card slot	PCIe Mini card slot	MINI_PCIE1
PCIe Mini card slot (supports mSATA)	PCIe Mini card slot	M_SATA1
Power button connector	2-pin header	PWR_BTN1
Power source connector	4-pin Molex	PWR1
Reset button connector	2-pin header	RST_BTN2
Resistive touchscreen connector	9-pin wafer	TOUCH1
RS-232 connector	10-pin header	COM4
RS-232 connector	10-pin header	COM5
SATA 6Gb/s connectors	SATA connector	SATA1, SATA2
SATA power connectors	4-pin wafer	SATA_PWR1, SATA_PWR2
SMBus connector	4-pin wafer	SMB1
SO-DIMM connectors	SO-DIMM connector	DIMM1, DIMM2
SPI flash connector	6-pin wafer	JSPI1
SPI flash (EC) connector	6-pin wafer	JSPI2
U3 firmware programming connector	9-pin wafer	JP2
USB 2.0 connector	4-pin wafer	USB1

Table 6-1: Peripheral Interface Connectors

6.2.1 Audio Connector (AUDIO1)

PIN NO.	DESCRIPTION	PIN NO.	DESCRIPTION
1	SPK_OUT-R	2	LINE_IN-R
3	GND	4	GND
5	SPK_OUT-L	6	LINE_IN-L
7	GND	8	GND
9	MIC-R	10	MIC-L

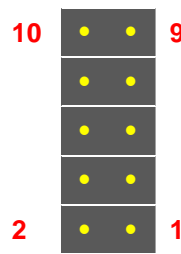

Table 6-2: Audio Connector (AUDIO1) Pinouts

6.2.2 Chassis Intrusion Connector (CHASSIS1)

PIN NO.	DESCRIPTION
1	+V3.3A_EC
2	CHASSIE_EC

Table 6-3: Chassis Intrusion Connector (CHASSIS1) Pinouts

6.2.3 Debug Port (DBG_PORT1)

PIN NO.	DESCRIPTION
1	GND
2	CLK_PCI_TPM
3	PLTRST_N
4	LPC_FRAME#
5	LPC_AD0
6	LPC_AD1
7	LPC_AD2
8	LPC_AD3
9	INT_SERIRQ
10	GND
11	+3.3V
12	--

Table 6-4: Debug Port (DBG_PORT1) Pinouts

6.2.4 DIO Connector (DIO1)

PIN NO.	DESCRIPTION	PIN NO.	DESCRIPTION
1	GND	2	VCC
3	Output 3	4	Output 2
5	Output 1	6	Output 0
7	Input 3	8	Input 2
9	Input 1	10	Input 0

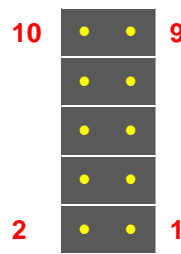

Table 6-5: DIO Connector (DIO1) Pinouts

6.2.5 EC Debug Port (CN2)

PIN NO.	DESCRIPTION
1	EC_EPP_STB#
2	EC_EPP_AFD#
3	EC_EPP_PD0
4	NC
5	EC_EPP_PD1
6	EC_EPP_INIT#
7	EC_EPP_PD2
8	EC_EPP_SLIN#
9	EC_EPP_PD3
10	GND
11	EC_EPP_PD4
12	NC
13	EC_EPP_PD5
14	EC_EPP_BUSY
15	EC_EPP_PD6
16	EC_EPP_KSI5
17	EC_EPP_PD7
18	EC_EPP_KSI4

Table 6-6: EC Debug Port (CN2) Pinouts

6.2.6 Fan Connector (CPU_FAN1)

PIN NO.	DESCRIPTION
1	GND
2	+12V
3	FANIO
4	PWM

Table 6-7: Fan Connector (CPU_FAN1) Pinouts

6.2.7 Front Panel Connector (F_PANEL1)

PIN NO.	DESCRIPTION
1	+5V
2	GND
3	PWR_LED+
4	PWR_LED-
5	HDD_LED+
6	HDD_LED-

Table 6-8: Front Panel Connector (F_PANEL1) Pinouts

6.2.8 I²C Connector (I2C1)

PIN NO.	DESCRIPTION
1	GND
2	I2C_DAT
3	I2C_CLK
4	+5V

Table 6-9: I²C Connector (I2C1) Pinouts

6.2.9 IPMI Active LED Connector (LEDCN1)

PIN NO.	DESCRIPTION
1	IPMI_LED+
2	IPMI_LED-

Table 6-10: IPMI Active LED Connector (LEDCN1) Pinouts

6.2.10 Keyboard and Mouse Connector (KB_MS1)

PIN NO.	DESCRIPTION
1	VCC5_KBMS
2	MSDATA
3	MSCLK
4	KBDATA
5	KBCLK
6	KBGND

Table 6-11: Keyboard and Mouse Connector (KB_MS1) Pinouts

6.2.11 Keypad Connector (OSD1)

PIN NO.	DESCRIPTION
1	+5V
2	AUTO_DIMMING
3	LOCK_BUTTON
4	VOL+
5	VOL-
6	BRIGHT+
7	BRIGHT-
8	LCD ON_OFF
9	GND

Table 6-12: Keypad Connector (OSD1) Pinouts

6.2.12 LAN Active LED Connectors (LAN_LED1)

PIN NO.	DESCRIPTION	PIN NO.	DESCRIPTION
1	LAN1_LINK_ACT1-	2	+V3.3LAN1
3	LAN2_LINK_ACT1-	4	+V3.3LAN2

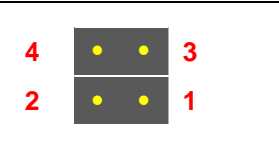

Table 6-13: LAN Active LED Connectors (LAN_LED1) Pinouts

6.2.13 LVDS Connector (LVDS1)

PIN NO.	DESCRIPTION	PIN NO.	DESCRIPTION
1	GND	2	GND
3	LVDS_A_TX0-P	4	LVDS_A_TX0-N
5	LVDS_A_TX1-P	6	LVDS_A_TX1-N
7	LVDS_A_TX2-P	8	LVDS_A_TX2-N
9	LVDS_A_TXCLK-P	10	LVDS_A_TXCLK-N
11	LVDS_A_TX3-P	12	LVDS_A_TX3-N
13	GND	14	GND
15	LVDS_B_TX0-P	16	LVDS_B_TX0-N
17	LVDS_B_TX1-P	18	LVDS_B_TX1-N
19	LVDS_B_TX2-P	20	LVDS_B_TX2-N
21	LVDS_B_TXCLK-P	22	LVDS_B_TXCLK-N
23	LVDS_B_TX3-P	24	LVDS_B_TX3-N
25	GND	26	GND
27	+LCD Vcc	28	+LCD Vcc
29	+LCD Vcc	30	+LCD Vcc

Table 6-14: LVDS Connector (LVDS1) Pinouts

6.2.14 LVDS Backlight Connector (INVERTER1)

PIN NO.	DESCRIPTION
1	+12V
2	+12V
3	Backlight ON/OFF
4	Backlight Brightness Control
5	GND
6	GND

Table 6-15: LVDS Backlight Connector (INVERTER1) Pinouts

6.2.15 PCIe Mini (MINI_PCIE1) and mSATA (M_SATA1) Card Slots

PIN NO.	DESCRIPTION	PIN NO.	DESCRIPTION
1	PCIE_WAKE#	2	+3.3V
3	N/C	4	GND
5	N/C	6	+1.5V
7	N/C	8	N/C
9	GND	10	N/C
11	CLK-	12	N/C
13	CLK+	14	N/C
15	GND	16	N/C
17	PCIRST#	18	GND
19	N/C	20	+3.3V
21	GND	22	PCIRST#
23	PERN (SATA_RX+)	24	+3VDual
25	PERP (SATA_RX-)	26	GND
27	GND	28	+1.5V
29	GND	30	SMBCLK
31	PETN (SATA_TX-)	32	SMBDATA
33	PETP (SATA_TX+)	34	GND
35	GND	36	USBD-

PIN NO.	DESCRIPTION	PIN NO.	DESCRIPTION
37	N/C	38	USBD+
39	N/C	40	GND
41	N/C	42	N/C
43	N/C	44	N/C
45	N/C	46	N/C
47	N/C	48	+1.5V
49	N/C	50	GND
51	MSATA_SEL#	52	+3.3V

Table 6-16: PCIe Mini (MINI_PCIE1) and mSATA (M_SATA1) Card Pinouts

6.2.16 Power Button Connector (PWR_BTN1)

PIN NO.	DESCRIPTION
1	PWR_BTN+
2	PWR_BTN-

Table 6-17: Power Button Connector (PWR_BTN1) Pinouts

6.2.17 Power Source Connector (PWR1)

PIN NO.	DESCRIPTION
1	GND
2	GND
3	DC 9V~36V+
4	DC 9V~36V+

Table 6-18: Power Source Connector (PWR1) Pinouts

6.2.18 Reset Button Connector (RST_BTN2)

PIN NO.	DESCRIPTION
1	BTN_SYSRST#
2	GND

Table 6-19: Reset Button Connector (RST_BTN2) Pinouts

6.2.19 Resistive Touchscreen Connector (TOUCH1)

PIN NO.	8-Wire	4-Wire	5-Wire
1	Right Sense	N/A	N/A
2	Left Sense	N/A	N/A
3	Bottom Sense	N/A	N/A
4	Top Sense	N/A	Sense (S)
5	Right Excite	Right	LR (X)
6	Left Excite	Left	LL (L)
7	Bottom Excite	Bottom	UR (H)
8	Top Excite	Top	UL (Y)
9	GND	GND	GND

Table 6-20: Resistive Touchscreen Connector (TOUCH1) Pinouts

6.2.20 RS-232 Connector (COM4, COM5)

PIN NO.	DESCRIPTION	PIN NO.	DESCRIPTION
1	-NDCD	2	-NDSR
3	NSIN	4	-NRTS
5	NSOUT	6	-NCTS
7	-NDTR	8	-XRI
9	GND	10	GND

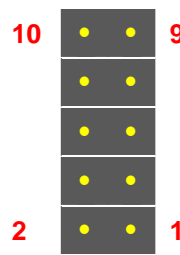

Table 6-21: RS-232 Connector (COM4, COM5) Pinouts

6.2.21 SATA 6Gb/s Connectors (SATA1, SATA2)

PIN NO.	DESCRIPTION
1	GND
2	SATA_TX+
3	SATA_TX-
4	GND
5	SATA_RX-
6	SATA_RX+
7	GND

Table 6-22: SATA 6Gb/s Connectors (SATA1, SATA2) Pinouts

6.2.22 SATA Power Connectors (SATA_PWR1, SATA_PWR2)

PIN NO.	DESCRIPTION
1	+12V
2	GND
3	GND
4	+5V

Table 6-23: SATA Power Connectors (SATA_PWR1, SATA_PWR2) Pinouts

6.2.23 SMBus Connector (SMB1)

PIN NO.	DESCRIPTION
1	GND
2	SMB_DATA
3	SMB_CLK
4	+5V

Table 6-24: SMBus Connector (SMB1) Pinouts

6.2.24 SPI Flash Connector (JSPI1)

PIN NO.	DESCRIPTION
1	+V3.3M_SPI_CON
2	SPI_CS
3	SPI_SO_SW
4	SPI_CLK_SW
5	SPI_SI_SW
6	GND

Table 6-25: SPI Flash Connector (JSPI1) Pinouts

6.2.25 SPI Flash (EC) Connector (JSPI2)

PIN NO.	DESCRIPTION
1	+V3.3M_SPI_CON_EC
2	SPI_CS#0_CN_EC
3	SPI_SO_SW_EC
4	SPI_CLK_SW_EC
5	SPI_SI_SW_EC
6	GND

Table 6-26: SPI Flash (EC) Connector (JSPI2) Pinouts

6.2.26 U3 Firmware Programming Connector (JP2)

PIN NO.	DESCRIPTION
1	MCLR
2	VCC5_MCU
3	GND
4	ICSPCLK
5	ICSPDAT
6	GND
7	MCU_IR
8	AUTO_CLK

9	AUTO_DATA
---	-----------

Table 6-27: U3 Firmware Programming Connector (JP2) Pinouts

6.2.27 USB 2.0 Connector (USB1)

PIN NO.	DESCRIPTION
1	+5V
2	USB_DATA-
3	USB_DATA+
4	GND

Table 6-28: USB 2.0 Connector (USB1) Pinouts

6.3 External Interface Panel Connectors

The table below lists the rear panel connectors on the PPC-F12B/15B/17B/19B-BTi motherboard. Pinouts of these connectors can be found in the following sections.

Connector	Type	Label
ATX/AT mode switch	Switch	J_ATX_AT1
Clear CMOS button	Push button	J_CMOS1
HDMI connector	HDMI	HDMI1
GbE connector	RJ-45	LAN1, LAN2
Reset button	Push button	RST_BTN1
RS-232 serial ports	DB-9	COM1, COM2
RS-232/422/485 serial port	DB-9	COM3
USB 2.0 connectors	USB 2.0 port	USB_CON1
USB 3.0 connectors	USB 3.0 port	USB3_CON1
VGA connector	15-pin female	VGA1

Table 6-29: Rear Panel Connectors

6.3.1 HDMI Connector (HDMI1)

PIN NO.	DESCRIPTION	PIN NO.	DESCRIPTION
1	HDMI_DATA2+	11	GND
2	GND	12	HDMI_CLK#
3	HDMI_DATA2#-	13	N/C
4	HDMI_DATA1+	14	N/C
5	GND	15	HDMI_SCL
6	HDMI_DATA1#-	16	HDMI_SDA
7	HDMI_DATA0+	17	GND
8	GND	18	+5VCC
9	HDMI_DATA0#-	19	HDMI_HPD
10	HDMI_CLK+		

Table 6-30: HDMI Connector (HDMI1) Pinouts

6.3.2 GbE Connectors (LAN1, LAN2)

PIN NO.	DESCRIPTION	PIN NO.	DESCRIPTION
1	MDIA0-	5	MDIA2+
2	MDIA0+	6	MDIA1+
3	MDIA1-	7	MDIA3-
4	MDIA2-	8	MDIA3+

Table 6-31: RJ-45 GbE Connector (LAN1, LAN2) Pinouts

6.3.3 RS-232 Serial Ports (COM1, COM2)

PIN NO.	DESCRIPTION	PIN NO.	DESCRIPTION
1	DCD	2	RXD
3	TXD	4	DTR
5	GND	6	DSR
7	RTS	8	CTS
9	RI		

Table 6-32: RS-232 Serial Port (COM1, COM2) Pinouts

6.3.4 RS-232/422/485 Serial Port (COM3)

PIN NO.	RS-232	RS-422	RS-485
1	DCD	TXD422-	TXD485-
2	RXD	TXD422+	TXD485+
3	TXD	RXD422+	--
4	DTR	RXD422-	--
5	GND	--	--
6	DSR	--	--
7	RTS	--	--
8	CTS	--	--
9	RI	--	--

Table 6-33: RS-232/422/485 Serial Port (COM3) Pinouts

6.3.5 USB 2.0 Connectors (USB_CON1)

PIN NO.	DESCRIPTION
1	VCC
2	USB_DATA-
3	USB_DATA+
4	GND

Table 6-34: USB 2.0 Connector (USB_CON1) Pinouts

6.3.6 USB 3.0 Connectors (USB3_CON1)

PIN NO.	DESCRIPTION	PIN NO.	DESCRIPTION
1	VCC	10	VCC
2	USB_DATA-	11	USB_DATA-
3	USB_DATA+	12	USB_DATA+
4	GND	13	GND
5	USB3_RX-	14	USB3_RX-
6	USB3_RX+	15	USB3_RX+
7	GND	16	GND

PPC-F12B/15B/17B/19B-BTi Panel PC

8	USB3_TX-	17	USB3_TX-
9	USB3_TX+	18	USB3_TX+

Table 6-35: USB 3.0 Connector (USB3_CON1) Pinouts

6.3.7 VGA Connector (VGA1)

PIN NO.	DESCRIPTION	PIN NO.	DESCRIPTION
1	RED	9	VCC
2	GREEN	10	GROUND
3	BLUE	11	NC
4	NC	12	DDCDA
5	GROUND	13	HSYNC
6	GROUND	14	VSYNC
7	GROUND	15	DDCCLK
8	GROUND		

Table 6-36: VGA Connector (VGA1) Pinouts

6.4 Preconfigured Jumpers

The following jumpers are preconfigured for the PPC-F12B/15B/17B/19B-BTi.



WARNING:

Users should not change these jumpers (**Table 6-37**). It is only for reference.

Jumper Name	Type	Label
Backlight voltage selection	3-pin header	JP1
LVDS panel resolution selection	DIP switch	SW1
Panel voltage selection	6-pin header	JLCD_PWR1

Table 6-37: Preconfigured Jumpers

6.4.1 Backlight Voltage Selection Jumper (JP1)

Pin	Description
Short 1-2	+5V
Short 2-3	+3.3V (Default)

Table 6-38: Panel Voltage Selection Jumper (JP1) Settings

6.4.2 LVDS Panel Resolution Selection Switch (SW1)

* ON=0, OFF=1; Single=S, Dual=D

SW1 (4-3-2-1)	Description
0000	800x600 18-bit S (default)
0001	1024x768 18-bit S
0010	1024x768 24-bit S
0011	1280x768 18-bit S
0100	1280x800 18-bit S
0101	1280x960 18-bit S
0110	1280x1024 24-bit D
0111	1366x768 18-bit S
1000	1366x768 24-bit S
1001	1440x960 24-bit D
1010	1400x1050 24-bit D
1011	1600x900 24-bit D
1100	1680x1050 24-bit D
1101	1600x1200 24-bit D
1110	1920x1080 24-bit D
1111	1920x1200 24-bit D

Table 6-39: LVDS Panel Resolution Selection

PPC-F12B/15B/17B/19B-BTi Panel PC

6.4.3 Panel Voltage Selection Jumper (JLCD_PWR1)

Pin	Description
Short 1-2	+3.3V (Default)
Short 3-4	+5V
Short 5-6	+12V

Table 6-40: Panel Voltage Selection Jumper (JLCD_PWR1) Settings

Appendix

A

Regulatory Compliance

DECLARATION OF CONFORMITY

This equipment is in conformity with the following EU directives:

- EMC Directive (2004/108/EC, 2014/30/EU)
- Low-Voltage Directive (2006/95/EC, 2014/35/EU)
- RoHS II Directive (2011/65/EU, 2015/863/EU)
- Ecodesign Directive 2009/125/EC

If the user modifies and/or install other devices in the equipment, the CE conformity declaration may no longer apply.

If this equipment has telecommunications functionality, it also complies with the requirements of the Radio Equipment Directive 2014/53/EU.

English

IEI Integration Corp declares that this equipment is in compliance with the essential requirements and other relevant provisions of Directive 2014/53/EU.

Български [Bulgarian]

IEI Integration Corp. декларира, че този оборудване е в съответствие със съществените изисквания и другите приложими правила на Директива 2014/53/EU.

Česky [Czech]

IEI Integration Corp tímto prohlašuje, že tento zařizení je ve shodě se základními požadavky a dalšími příslušnými ustanoveními směrnice 2014/53/EU.

Dansk [Danish]

IEI Integration Corp erklærer herved, at følgende udstyr overholder de væsentlige krav og øvrige relevante krav i direktiv 2014/53/EU.

Deutsch [German]

IEI Integration Corp, erklärt dieses Gerät entspricht den grundlegenden Anforderungen und den weiteren entsprechenden Vorgaben der Richtlinie 2014/53/EU.

Eesti [Estonian]

IEI Integration Corp deklareerib seadme seadme vastavust direktiivi 2014/53/EÜ põhinõuetele ja nimetatud direktiivist tulenevatele teistele asjakohastele sätetele.

Español [Spanish]

IEI Integration Corp declara que el equipo cumple con los requisitos esenciales y cualesquiera otras disposiciones aplicables o exigibles de la Directiva 2014/53/EU.

Ελληνική [Greek]

IEI Integration Corp ΔΗΛΩΝΕΙ ΟΤΙ ΕΞΟΠΛΙΣΜΟΣ ΣΥΜΜΟΡΦΩΝΕΤΑΙ ΠΡΟΣ ΤΙΣ ΟΥΣΙΩΔΕΙΣ ΑΠΑΙΤΗΣΕΙΣ ΚΑΙ ΤΙΣ ΛΟΙΠΕΣ ΣΧΕΤΙΚΕΣ ΔΙΑΤΑΞΕΙΣ ΤΗΣ ΟΔΗΓΙΑΣ 2014/53/EU.

Français [French]

IEI Integration Corp déclare que l'appareil est conforme aux exigences essentielles et aux autres dispositions pertinentes de la directive 2014/53/EU.

Italiano [Italian]

IEI Integration Corp dichiara che questo apparecchio è conforme ai requisiti essenziali ed alle altre disposizioni pertinenti stabilite dalla direttiva 2014/53/EU.

Latviski [Latvian]

IEI Integration Corp deklarē, ka iekārta atbilst būtiskajām prasībām un citiem ar to saistītajiem noteikumiem Direktīvas 2014/53/EU.

Lietuvių [Lithuanian]

IEI Integration Corp deklaruoja, kad šis įranga atitinka esminius reikalavimus ir kitas 2014/53/EU Direktyvos nuostatas.

Nederlands [Dutch]

IEI Integration Corp dat het toestel toestel in overeenstemming is met de essentiële eisen en de andere relevante bepalingen van richtlijn 2014/53/EU.

Malti [Maltese]

IEI Integration Corp jiddikjara li dan prodott jikkonforma mal-ħtiġijiet essenzjali u ma provvedimenti oħrajn relevanti li hemm fid-Dirrettiva 2014/53/EU.

Magyar [Hungarian]

IEI Integration Corp nyilatkozom, hogy a berendezés megfelel a vonatkozó alapvető követelményeknek és az 2014/53/EU irányelv egyéb előírásainak.

Polski [Polish]

IEI Integration Corp oświadcza, że wyrobu jest zgodny z zasadniczymi wymogami oraz pozostałymi stosownymi postanowieniami Dyrektywy 2014/53/EU.

Português [Portuguese]

IEI Integration Corp declara que este equipamento está conforme com os requisitos essenciais e outras disposições da Directiva 2014/53/EU.

PPC-F12B/15B/17B/19B-BTi Panel PC

Româna [Romanian]

IEI Integration Corp declară că acest echipament este în conformitate cu cerințele esențiale și cu celelalte prevederi relevante ale Directivei 2014/53/EU.

Slovensko [Slovenian]

IEI Integration Corp izjavlja, da je ta opreme v skladu z bistvenimi zahtevami in ostalimi relevantnimi določili direktive 2014/53/EU.

Slovensky [Slovak]

IEI Integration Corp týmto vyhlasuje, že zariadenia spĺňa základné požiadavky a všetky príslušné ustanovenia Smernice 2014/53/EU.

Suomi [Finnish]

IEI Integration Corp vakuuttaa täten että laitteet on direktiivin 2014/53/EU oleellisten vaatimusten ja sitä koskevien direktiivin muiden ehtojen mukainen.

Svenska [Swedish]

IEI Integration Corp förklarar att denna utrustningstyp står i överensstämmelse med de väsentliga egenskapskrav och övriga relevanta bestämmelser som framgår av direktiv 2014/53/EU.

FCC WARNING

This equipment complies with Part 15 of the FCC Rules. Operation is subject to the following two conditions:

- This device may not cause harmful interference, and
- This device must accept any interference received, including interference that may cause undesired operation.

This equipment has been tested and found to comply with the limits for a Class A digital device, pursuant to part 15 of the FCC Rules. These limits are designed to provide reasonable protection against harmful interference when the equipment is operated in a commercial environment. This equipment generates, uses, and can radiate radio frequency energy and, if not installed and used in accordance with the instruction manual, may cause harmful interference to radio communications. Operation of this equipment in a residential area is likely to cause harmful interference in which case the user will be required to correct the interference at his own expense.

Federal Communication Commission Interference Statement

This equipment has been assembled with components that comply with the limits for a Class B digital device, pursuant to Part 15 of the FCC Rules. These limits are designed to provide reasonable protection against harmful interference in a residential installation. This equipment generates, uses and can radiate radio frequency energy and, if not installed and used in accordance with the instructions, may cause harmful interference to radio communications. However, there is no guarantee that interference will not occur in a particular installation. If this equipment does cause harmful interference to radio or television reception, which can be determined by turning the equipment off and on, the user is encouraged to try to correct the interference by one of the following measures:

- Reorient or relocate the receiving antenna.
- Increase the separation between the equipment and receiver.
- Connect the equipment into an outlet on a circuit different from that to which the receiver is connected.
- Consult the dealer or an experienced radio/TV technician for help.

Appendix

B

BIOS Configuration Options

B.1 BIOS Configuration Options

Below is a list of BIOS configuration options described in **Chapter 5**.

System Date [xx/xx/xx]	65
System Time [xx:xx:xx]	65
Serial Port [Enabled].....	67
Change Settings [Auto]	67
Serial Port [Enabled].....	68
Change Settings [Auto]	68
Serial Port [Enabled].....	69
Change Settings [Auto]	69
Serial Port Mode [RS232]	70
PC Health Status	70
Wake system with Fixed Time [Disabled].....	72
Console Redirection [Disabled]	73
Terminal Type [ANSI].....	74
Bits per second [115200].....	74
Data Bits [8]	75
Parity [None].....	75
Stop Bits [1].....	75
Auto Recovery Function [Disabled].....	76
Intel Virtualization Technology [Enabled]	78
EIST [Enabled].....	78
Serial-ATA (SATA) [Enabled]	79
SATA Mode Selection [IDE Mode]	79
USB Devices	80
Legacy USB Support [Enabled].....	80
Primary Display [Auto]	83
DVMT Pre-Allocated [256M]	83
DVMT Total Gfx Mem [Max].....	83
Primary IGFX Boot Display [VBIOS Default]	83
Auto Power Button Status [Enable (AT)].....	84
Restore AC Power Loss [Last State]	85
Audio Controller [Enabled]	85

PPC-F12B/15B/17B/19B-BTi Panel PC

XHCI Mode [Enabled].....	85
Speed [Auto].....	86
Administrator Password	87
User Password	87
Bootup NumLock State [On].....	88
Quiet Boot [Enabled]	89
UEFI Boot [Disabled]	89
OS Selection [Windows 8.x].....	89
Launch PXE OpROM [Disabled]	90
Option ROM Messages [Force BIOS].....	90
Save Changes and Reset	91
Discard Changes and Reset	91
Restore Defaults	91
Save as User Defaults	91
Restore User Defaults	91
SEL Components [Enabled].....	93
Erase SEL [No]	93
When SEL is Full [Do Nothing].....	94
Configuration Address source [Unspecified]	95

Appendix

C

Safety Precautions

**WARNING:**

The precautions outlined in this chapter should be strictly followed. Failure to follow these precautions may result in permanent damage to the PPC-F12B/15B/17B/19B-BTi.

C.1 Safety Precautions

Please follow the safety precautions outlined in the sections that follow:

C.1.1 General Safety Precautions

Please ensure the following safety precautions are adhered to at all times.

- ***Follow the electrostatic precautions*** outlined below whenever the device is opened.
- ***Make sure the power is turned off and the power cord is disconnected*** whenever the PPC-F12B/15B/17B/19B-BTi is being installed, moved or modified.
- ***To prevent the risk of electric shock, make sure power cord is unplugged from wall socket.*** To fully disengage the power to the unit, please disconnect the power cord from the AC outlet. Refer servicing to qualified service personnel. The AC outlet shall be readily available and accessible.
- ***Do not apply voltage levels that exceed the specified voltage range.*** Doing so may cause fire and/or an electrical shock. Use a power cord that matches the voltage of the power outlet, which has been approved and complies with the safety standard of your particular country.
- ***Electric shocks can occur*** if the PPC-F12B/15B/17B/19B-BTi chassis is opened when it is running. To avoid risk of electric shock, this device must only be connected to a supply mains with protective earth.
- ***Do not drop or insert any objects*** into the ventilation openings of the PPC-F12B/15B/17B/19B-BTi.

- **If considerable amounts of dust, water, or fluids enter the device**, turn off the power supply immediately, unplug the power cord, and contact the PPC-F12B/15B/17B/19B-BTi vendor.
- **DO NOT:**
 - Drop the device against a hard surface.
 - Strike or exert excessive force onto the LCD panel.
 - Touch any of the LCD panels with a sharp object
 - In a site where the ambient temperature exceeds the rated temperature

C.1.2 Anti-static Precautions



WARNING:

Failure to take ESD precautions during the installation of the PPC-F12B/15B/17B/19B-BTi may result in permanent damage to the PPC-F12B/15B/17B/19B-BTi and severe injury to the user.

Electrostatic discharge (ESD) can cause serious damage to electronic components, including the PPC-F12B/15B/17B/19B-BTi. Dry climates are especially susceptible to ESD. It is therefore critical that whenever the PPC-F12B/15B/17B/19B-BTi is opened and any of the electrical components are handled, the following anti-static precautions are strictly adhered to.

- **Wear an anti-static wristband:** Wearing a simple anti-static wristband can help to prevent ESD from damaging any electrical component.
- **Self-grounding:** Before handling any electrical component, touch any grounded conducting material. During the time the electrical component is handled, frequently touch any conducting materials that are connected to the ground.
- **Use an anti-static pad:** When configuring or working with an electrical component, place it on an anti-static pad. This reduces the possibility of ESD damage.
- **Only handle the edges of the electrical component:** When handling the electrical component, hold the electrical component by its edges.

C.1.3 Product Disposal

**CAUTION:**

Risk of explosion if battery is replaced by an incorrect type. Only certified engineers should replace the on-board battery.

Dispose of used batteries according to instructions and local regulations.

- Outside the European Union – If you wish to dispose of used electrical and electronic products outside the European Union, please contact your local authority so as to comply with the correct disposal method.
- Within the European Union – The device that produces less waste and is easier to recycle is classified as electronic device in terms of the European Directive 2012/19/EU (WEEE), and must not be disposed of as domestic garbage.

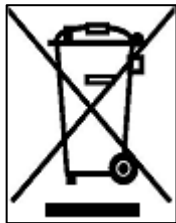

EU-wide legislation, as implemented in each Member State, requires that waste electrical and electronic products carrying the mark (left) must be disposed of separately from normal household waste. This includes monitors and electrical accessories, such as signal cables or power cords. When you need to dispose of your display products, please follow the guidance of your local authority, or ask the shop where you purchased the product. The mark on electrical and electronic products only applies to the current European Union Member States.

Please follow the national guidelines for electrical and electronic product disposal.

C.2 Maintenance and Cleaning Precautions

When maintaining or cleaning the PPC-F12B/15B/17B/19B-BTi, please follow the guidelines below.



WARNING:

- For safety reasons, turn-off the power and unplug the panel PC before cleaning.
 - If you dropped any material or liquid such as water onto the panel PC when cleaning, unplug the power cable immediately and contact your dealer or the nearest service center. Always make sure your hands are dry when unplugging the power cable.
-

C.2.1 Maintenance and Cleaning

Prior to cleaning any part or component of the PPC-F12B/15B/17B/19B-BTi, please read the details below.

- Except for the LCD panel, never spray or squirt liquids directly onto any other components. To clean the LCD panel, gently wipe it with a piece of soft dry cloth or a slightly moistened cloth.
- The interior of the device does not require cleaning. Keep fluids away from the device interior.
- Be cautious of all small removable components when vacuuming the device.
- Never drop any objects or liquids through the openings of the device.
- Be cautious of any possible allergic reactions to solvents or chemicals used when cleaning the device.
- Avoid eating, drinking and smoking within vicinity of the device.

C.2.2 Cleaning Tools

Some components in the PPC-F12B/15B/17B/19B-BTi may only be cleaned using a product specifically designed for the purpose. In such case, the product will be explicitly mentioned in the cleaning tips. Below is a list of items to use when cleaning the PPC-F12B/15B/17B/19B-BTi.

PPC-F12B/15B/17B/19B-BTi Panel PC

- **Cloth** – Although paper towels or tissues can be used, a soft, clean piece of cloth is recommended when cleaning the device.
- **Water or rubbing alcohol** – A cloth moistened with water or rubbing alcohol can be used to clean the device.
- **Using solvents** – The use of solvents is not recommended when cleaning the device as they may damage the plastic parts.
- **Vacuum cleaner** – Using a vacuum specifically designed for computers is one of the best methods of cleaning the device. Dust and dirt can restrict the airflow in the device and cause its circuitry to corrode.
- **Cotton swabs** – Cotton swabs moistened with rubbing alcohol or water are excellent tools for wiping hard to reach areas.
- **Foam swabs** – Whenever possible, it is best to use lint free swabs such as foam swabs for cleaning.

Appendix

D

Watchdog Timer



NOTE:

The following discussion applies to DOS environment. IEI support is contacted or the IEI website visited for specific drivers for more sophisticated operating systems, e.g., Windows and Linux.

The Watchdog Timer is provided to ensure that standalone systems can always recover from catastrophic conditions that cause the CPU to crash. This condition may have occurred by external EMI or a software bug. When the CPU stops working correctly, Watchdog Timer either performs a hardware reset (cold boot) or a Non-Maskable Interrupt (NMI) to bring the system back to a known state.

A BIOS function call (INT 15H) is used to control the Watchdog Timer:

INT 15H:

AH – 6FH Sub-function:	
AL – 2:	Sets the Watchdog Timer's period.
BL:	Time-out value (Its unit-second is dependent on the item "Watchdog Timer unit select" in CMOS setup).

Table D-1: AH-6FH Sub-function

Call sub-function 2 to set the time-out period of Watchdog Timer first. If the time-out value is not zero, the Watchdog Timer starts counting down. While the timer value reaches zero, the system resets. To ensure that this reset condition does not occur, calling sub-function 2 must periodically refresh the Watchdog Timer. However, the Watchdog timer is disabled if the time-out value is set to zero.

A tolerance of at least 10% must be maintained to avoid unknown routines within the operating system (DOS), such as disk I/O that can be very time-consuming.

**NOTE:**

When exiting a program it is necessary to disable the Watchdog Timer, otherwise the system resets.

Example program:

```
; INITIAL TIMER PERIOD COUNTER
;
W_LOOP:

    MOV     AX, 6F02H      ;setting the time-out value
    MOV     BX, 05        ;time-out value is 5 seconds
    INT     15H

;
; ADD THE APPLICATION PROGRAM HERE
;

    CMP     EXIT_AP, 1    ;is the application over?
    JNE     W_LOOP       ;No, restart the application

    MOV     AX, 6F02H    ;disable Watchdog Timer
    MOV     BX, 0        ;
    INT     15H

;
; EXIT ;
```

Appendix

E

Hazardous Materials Disclosure

The details provided in this appendix are to ensure that the product is compliant with the Peoples Republic of China (China) RoHS standards. The table below acknowledges the presences of small quantities of certain materials in the product, and is applicable to China RoHS only.

A label will be placed on each product to indicate the estimated “Environmentally Friendly Use Period” (EFUP). This is an estimate of the number of years that these substances would “not leak out or undergo abrupt change.” This product may contain replaceable sub-assemblies/components which have a shorter EFUP such as batteries and lamps. These components will be separately marked.

Please refer to the following table.

Part Name	Toxic or Hazardous Substances and Elements					
	Lead (Pb)	Mercury (Hg)	Cadmium (Cd)	Hexavalent Chromium (CR(VI))	Polybrominated Biphenyls (PBB)	Polybrominated Diphenyl Ethers (PBDE)
Housing	O	O	O	O	O	O
Display	O	O	O	O	O	O
Printed Circuit Board	O	O	O	O	O	O
Metal Fasteners	O	O	O	O	O	O
Cable Assembly	O	O	O	O	O	O
Fan Assembly	O	O	O	O	O	O
Power Supply Assemblies	O	O	O	O	O	O
Battery	O	O	O	O	O	O
<p>O: This toxic or hazardous substance is contained in all of the homogeneous materials for the part is below the limit requirement in SJ/T11363-2006 (now replaced by GB/T 26572-2011).</p> <p>X: This toxic or hazardous substance is contained in at least one of the homogeneous materials for this part is above the limit requirement in SJ/T11363-2006 (now replaced by GB/T 26572-2011).</p>						

PPC-F12B/15B/17B/19B-BTi Panel PC

此附件旨在确保本产品符合中国 RoHS 标准。以下表格标示此产品中某有毒物质的含量符合中国 RoHS 标准规定的限量要求。

本产品上会附有“环境友好使用期限”的标签，此期限是估算这些物质“不会有泄漏或突变”的年限。本产品可能包含有较短的环境友好使用期限的可替换元件，像是电池或灯管，这些元件将会单独标示出来。

部件名称	有毒有害物质或元素					
	铅 (Pb)	汞 (Hg)	镉 (Cd)	六价铬 (CR(VI))	多溴联苯 (PBB)	多溴二苯 醚 (PBDE)
壳体	○	○	○	○	○	○
显示	○	○	○	○	○	○
印刷电路板	○	○	○	○	○	○
金属螺帽	○	○	○	○	○	○
电缆组装	○	○	○	○	○	○
风扇组装	○	○	○	○	○	○
电力供应组装	○	○	○	○	○	○
电池	○	○	○	○	○	○

○: 表示该有毒有害物质在该部件所有物质材料中的含量均在 SJ/T 11363-2006 (现由 GB/T 26572-2011 取代) 标准规定的限量要求以下。

X: 表示该有毒有害物质至少在该部件的某一均质材料中的含量超出 SJ/T 11363-2006 (现由 GB/T 26572-2011 取代) 标准规定的限量要求。