



MODEL:

TANK-820-H61 Series

Embedded System with 2nd Generation Intel® Core™ desktop processor, VGA, DVI-I, Two Gigabit Ethernet, Four USB 2.0, Two USB 3.0, RS-232/422/485, RoHS Compliant

User Manual

Revision

Date	Version	Changes
7 March 2016	2.06	Update Pin Define of RS-232 Serial Port Connector (COM1~COM4, COM7, COM8) Update Pin Define of RS-422/485 Serial Port Connector (COM5, COM6)
26 May 2015	2.05	Update P.N of System Fan
16 December 2014	2.04	Update Section 3.7.10: RJ-45 RS-422/485 Serial Ports
27 December 2013	2.03	Update BIOS version Updated Section 3.4: System Fan Installation
16 July 2013	2.02	Update Section 1.4: Technical Specifications (Operating Temperature : -20°C ~ 55°C)
19 June 2013	2.01	Update Section 1.2: Model Variations
22 May 2013	2.00	Change to fanless design
2 April 2013	1.01	Add backplane max. size
12 December 2012	1.00	Initial release

Copyright

COPYRIGHT NOTICE

The information in this document is subject to change without prior notice in order to improve reliability, design and function and does not represent a commitment on the part of the manufacturer.

In no event will the manufacturer be liable for direct, indirect, special, incidental, or consequential damages arising out of the use or inability to use the product or documentation, even if advised of the possibility of such damages.

This document contains proprietary information protected by copyright. All rights are reserved. No part of this manual may be reproduced by any mechanical, electronic, or other means in any form without prior written permission of the manufacturer.

TRADEMARKS

All registered trademarks and product names mentioned herein are used for identification purposes only and may be trademarks and/or registered trademarks of their respective owners.

Table of Contents

1 INTRODUCTION.....	1
1.1 OVERVIEW.....	2
1.2 MODEL VARIATIONS	3
1.3 FEATURES.....	3
1.4 TECHNICAL SPECIFICATIONS	3
1.5 FRONT PANEL.....	6
1.6 REAR PANEL.....	7
1.7 LED INDICATORS	8
1.8 BACKPLANE OPTIONS	9
1.9 DIMENSIONS.....	11
2 UNPACKING	12
2.1 ANTI-STATIC PRECAUTIONS	13
2.2 UNPACKING PRECAUTIONS.....	13
2.3 UNPACKING CHECKLIST	14
3 INSTALLATION	17
3.1 INSTALLATION PRECAUTIONS	18
3.2 CF CARD INSTALLATION	18
3.3 HARD DISK DRIVE (HDD) INSTALLATION.....	20
3.4 SYSTEM FAN INSTALLATION	22
3.5 MOUNTING THE SYSTEM WITH MOUNTING BRACKETS	23
3.6 FOOT PAD INSTALLATION	24
3.7 EXTERNAL PERIPHERAL INTERFACE CONNECTORS.....	25
3.7.1 ACC Mode Selection	26
3.7.2 AT/ATX Power Mode Selection.....	26
3.7.3 Audio Connector	27
3.7.4 CompactFlash® Type II.....	27
3.7.5 Digital Input/Output Connector.....	28
3.7.6 DVI Connector.....	28
3.7.7 LAN Connectors.....	29

TANK-820-H61 Embedded System

3.7.8	<i>Power Input, 3-pin Terminal Block</i>	31
3.7.9	<i>Power Input, 4-pin DIN Connector</i>	31
3.7.10	<i>RJ-45 RS-422/485 Serial Ports</i>	31
3.7.11	<i>RS-232 Serial Port Connectors</i>	33
3.7.12	<i>USB Connectors</i>	34
3.7.13	<i>VGA Connector</i>	35
3.8	POWERING ON/OFF THE SYSTEM	36
3.9	POWER	37
3.9.1	<i>ACC ON</i>	38
3.9.1.1	<i>Boot-up</i>	38
3.9.1.2	<i>Shutdown</i>	39
3.9.2	<i>ACC OFF</i>	40
3.9.2.1	<i>Boot-up</i>	40
3.9.2.2	<i>Shutdown</i>	41
4	SYSTEM MOTHERBOARD	42
4.1	OVERVIEW	43
4.1.1	<i>Layout</i>	43
4.2	INTERNAL PERIPHERAL CONNECTORS	44
4.2.1	<i>Battery Connector (BAT1)</i>	45
4.2.2	<i>BIOS Programming Connector (SPI2)</i>	45
4.2.3	<i>CPU Fan Connector (CPU_FAN1)</i>	45
4.2.4	<i>EC Debug Connector (CN4)</i>	45
4.2.5	<i>EC Programming Connector (JSP11)</i>	46
4.2.6	<i>LED Connector (J2)</i>	46
4.2.7	<i>PCH Fan Connector (PCH_FAN)</i>	46
4.2.8	<i>SATA 3Gb/s Drive Connectors (SATA1)</i>	47
4.2.9	<i>SATA Power Connector (CN1)</i>	47
4.2.10	<i>SMBus Connector (CN3)</i>	47
4.2.11	<i>TPM Connector (TPM1)</i>	47
4.3	EXTERNAL INTERFACE PANEL CONNECTORS	48
4.3.1	<i>Audio Jack (JAUDIO1)</i>	49
4.3.2	<i>DIO connector (DIO1)</i>	49
4.3.3	<i>DVI Connector (DVI_1)</i>	49
4.3.4	<i>Ethernet and USB2.0 Connectors (USBLAN1)</i>	50

4.3.5 Ethernet and USB2.0 Connectors (USBLAN2).....	50
4.3.6 Power Connector (PWR2)	51
4.3.7 Power Connector (PWR1)	51
4.3.8 RS-232 Serial Port Connector (COM1).....	51
4.3.9 RS-232 Serial Port Connector (COM2).....	51
4.3.10 RS-232 Serial Port Connector (COM3).....	52
4.3.11 RS-232 Serial Port Connector (COM4).....	52
4.3.12 RS-232 Serial Port Connector (COM7).....	52
4.3.13 RS-232 Serial Port Connector (COM8).....	53
4.3.14 RS-422/485 Serial Port Connectors (COM5).....	53
4.3.15 RS-422/485 Serial Port Connectors (COM6).....	53
4.3.16 USB 3.0 Connectors (USB3_12).....	53
4.3.17 VGA Connector (VGA1).....	54
4.4 JUMPER SETTINGS	54
4.4.1 Clear CMOS Setup (J_CMOS2)	54
5 BIOS.....	55
5.1 INTRODUCTION.....	56
5.1.1 Starting Setup.....	56
5.1.2 Using Setup	56
5.1.3 Getting Help.....	57
5.1.4 Unable to Reboot after Configuration Changes	57
5.1.5 BIOS Menu Bar.....	57
5.2 MAIN.....	59
5.3 ADVANCED.....	60
5.3.1 ACPI Settings	61
5.3.2 RTC Wake Settings	62
5.3.3 Trusted Computing.....	63
5.3.4 CPU Configuration.....	64
5.3.4.1 CPU Information.....	65
5.3.5 SATA Configuration	67
5.3.6 Intel TXT(LT) Configuration.....	67
5.3.7 USB Configuration.....	68
5.3.8 F81216 Secondary Super IO Configuration	69
5.3.8.1 Serial Port n Configuration	70

TANK-820-H61 Embedded System

5.3.9 F81866 Super IO Configuration	72
5.3.9.1 Serial Port n Configuration	72
5.3.10 F81866 H/W Monitor.....	78
5.3.10.1 Smart Fan Mode Configuration	78
5.3.11 Serial Port Console Redirection.....	82
5.3.11.1 Console Redirection Settings	83
5.3.12 iEi Feature.....	86
5.4 CHIPSET	87
5.4.1 PCH-IO Configuration	88
5.4.2 System Agent (SA) Configuration	89
5.4.2.1 Graphics Configuration.....	89
5.5 BOOT.....	91
5.6 SECURITY.....	93
5.7 EXIT	94
A ONE KEY RECOVERY	96
A.1 ONE KEY RECOVERY INTRODUCTION	97
A.1.1 System Requirement.....	98
A.1.2 Supported Operating System	99
A.2 SETUP PROCEDURE FOR WINDOWS.....	100
A.2.1 Hardware and BIOS Setup	101
A.2.2 Create Partitions	101
A.2.3 Install Operating System, Drivers and Applications.....	105
A.2.4 Build-up Recovery Partition.....	106
A.2.5 Create Factory Default Image.....	108
A.3 AUTO RECOVERY SETUP PROCEDURE.....	113
A.4 SETUP PROCEDURE FOR LINUX.....	117
A.5 RECOVERY TOOL FUNCTIONS	121
A.5.1 Factory Restore	122
A.5.2 Backup System.....	123
A.5.3 Restore Your Last Backup.....	124
A.5.4 Manual.....	125
A.6 RESTORE SYSTEMS FROM A LINUX SERVER THROUGH LAN.....	126
A.6.1 Configure DHCP Server Settings	127
A.6.2 Configure TFTP Settings	128

A.6.3	<i>Configure One Key Recovery Server Settings</i>	129
A.6.4	<i>Start the DHCP, TFTP and HTTP</i>	130
A.6.5	<i>Create Shared Directory</i>	130
A.6.6	<i>Setup a Client System for Auto Recovery</i>	131
A.7	OTHER INFORMATION	134
A.7.1	<i>Using AHCI Mode or ALi M5283 / VIA VT6421A Controller</i>	134
A.7.2	<i>System Memory Requirement</i>	136
B	SAFETY PRECAUTIONS	137
B.1	SAFETY PRECAUTIONS	138
B.1.1	<i>General Safety Precautions</i>	138
B.1.2	<i>Anti-static Precautions</i>	138
B.1.3	<i>Product Disposal</i>	139
B.2	MAINTENANCE AND CLEANING PRECAUTIONS	140
B.2.1	<i>Maintenance and Cleaning</i>	140
B.2.2	<i>Cleaning Tools</i>	140
C	HAZARDOUS MATERIALS DISCLOSURE	142
C.1	HAZARDOUS MATERIALS DISCLOSURE TABLE FOR IPB PRODUCTS CERTIFIED AS ROHS COMPLIANT UNDER 2002/95/EC WITHOUT MERCURY	143

List of Figures

Figure 1-1: TANK-820-H61	2
Figure 1-2: TANK-820-H61 Front Panel	6
Figure 1-3: TANK-820-H61 Rear Panel.....	7
Figure 1-4: TANK-820-H61 LED Indicators.....	8
Figure 1-5: HPE-3S6 (2P1E)	9
Figure 1-6: HPE-3S7 (1P2E)	9
Figure 1-7: Physical Dimensions (millimeters).....	11
Figure 3-1: CF Card Socket	19
Figure 3-2: CF Card Socket Cover	19
Figure 3-3: CF Card Installation	20
Figure 3-4: Unscrew the Cover.....	20
Figure 3-5: Remove the Cover from TANK-820-H61	21
Figure 3-6: HDD Installation	21
Figure 3-7: HDD Retention Screws	22
Figure 3-8: System Fan Installation	23
Figure 3-9: Mounting Bracket Retention Screws	24
Figure 3-10: Foot Pad Installation	25
Figure 3-11: ACC Mode Switch	26
Figure 3-12: AT/ATX Power Mode Switch	27
Figure 3-13: Audio Connector	27
Figure 3-14: DIO Connector	28
Figure 3-15: DVI Connector	29
Figure 3-16: LAN Connection	30
Figure 3-17: RJ-45 Ethernet Connector.....	30
Figure 3-18: 3-pin Terminal Block.....	31
Figure 3-19: Power Input Connector.....	31
Figure 3-20: RJ-45 RS-422/485 Serial Device Connection.....	32
Figure 3-21: RJ-45 RS-422/485 Serial Port Connector	32
Figure 3-22: DB-9 Connector Pinout Location	33
Figure 3-23: Serial Device Connector.....	34

Figure 3-24: DB-9 RS-232 Serial Port Connector	34
Figure 3-25: USB Device Connection	35
Figure 3-26: VGA Connector	36
Figure 3-27: VGA Connector	36
Figure 3-28: Power Button	37
Figure 3-29: Power Connectors	38
Figure 3-30: ACC On: AT Mode	39
Figure 3-31: ACC On: ATX Mode.....	39
Figure 3-32: ACC On: Shutdown.....	40
Figure 3-33: ACC Off: AT Mode.....	40
Figure 3-34: ACC Off: ATX Mode	41
Figure 3-35: ACC Off: Shutdown.....	41
Figure 4-1: System Motherboard (Front).....	43
Figure 4-2: System Motherboard (Rear).....	44
Figure A-1: IEI One Key Recovery Tool Menu	97
Figure A-2: Launching the Recovery Tool	102
Figure A-3: Recovery Tool Setup Menu	102
Figure A-4: Command Mode.....	103
Figure A-5: Partition Creation Commands.....	104
Figure A-6: Launching the Recovery Tool	106
Figure A-7: System Configuration for Windows	106
Figure A-8: Building the Recovery Partition.....	107
Figure A-9: Press Any Key to Continue	107
Figure A-10: Press F3 to Boot into Recovery Mode.....	108
Figure A-11: Recovery Tool Menu	108
Figure A-12: About Symantec Ghost Window.....	109
Figure A-13: Symantec Ghost Path	109
Figure A-14: Select a Local Source Drive	110
Figure A-15: Select a Source Partition from Basic Drive	110
Figure A-16: File Name to Copy Image to	111
Figure A-17: Compress Image.....	111
Figure A-18: Image Creation Confirmation	112
Figure A-19: Image Creation Process.....	112
Figure A-20: Image Creation Complete	112
Figure A-21: Press Any Key to Continue	113

TANK-820-H61 Embedded System

Figure A-22: Auto Recovery Utility	114
Figure A-23: Launching the Recovery Tool	114
Figure A-24: Auto Recovery Environment for Windows	114
Figure A-25: Building the Auto Recovery Partition.....	115
Figure A-26: Factory Default Image Confirmation	115
Figure A-27: Image Creation Complete	116
Figure A-28: Press any key to continue	116
Figure A-29: Partitions for Linux.....	118
Figure A-30: Manual Recovery Environment for Linux	119
Figure A-31: Access menu.lst in Linux (Text Mode).....	120
Figure A-32: Recovery Tool Menu	120
Figure A-33: Recovery Tool Main Menu	121
Figure A-34: Restore Factory Default	122
Figure A-35: Recovery Complete Window	123
Figure A-36: Backup System.....	123
Figure A-37: System Backup Complete Window	124
Figure A-38: Restore Backup	124
Figure A-39: Restore System Backup Complete Window	125
Figure A-40: Symantec Ghost Window	125

List of Tables

Table 1-1: TANK-820-H61 Model Variations	3
Table 1-2: Technical Specifications	5
Table 1-3: LED Indicators Description.....	8
Table 1-4: Supported Signals	9
Table 1-5: Rated Voltage and Current	10
Table 3-1: RJ-45 Ethernet Connector LEDs	30
Table 3-2: RJ-45 RS-422/485 Serial Port Pinouts	32
Table 3-3: DB-9 Connector Pinouts	33
Table 3-4: Power LED Indicators Description.....	38
Table 4-1: Peripheral Interface Connectors	45
Table 4-2: Battery Connector Pinouts (BAT1)	45
Table 4-3: BIOS Programming Connector Pinouts (SPI2).....	45
Table 4-4: CPU Fan Connector Pinouts (CPU_FAN1).....	45
Table 4-5: EC Debug Connector Pinouts (CN4).....	46
Table 4-6: EC Programming Connector Pinouts (JSPI1).....	46
Table 4-7: LED Connector Pinouts (J2).....	46
Table 4-8: PCH Fan Connector Pinouts (PCH_FAN).....	46
Table 4-9: SATA 3Gb/s Drive Connectors Pinouts (SATA1)	47
Table 4-10: SATA Power Connector Pinouts (CN1)	47
Table 4-11: SMBus Connector Pinouts (CN3).....	47
Table 4-12: TPM Connector Pinouts (TPM1).....	48
Table 4-13: Rear Panel Connectors	48
Table 4-14: Audio Jack Pinouts (AUDIO1)	49
Table 4-15: DIO connector Pinouts (DIO1).....	49
Table 4-16: DVI Connector Pinouts (DVI_1).....	50
Table 4-17: Ethernet and USB2.0 Connectors Pinouts (USBLAN1)	50
Table 4-18: Ethernet and USB2.0 Connectors Pinouts (USBLAN2)	51
Table 4-19: Power Connector Pinouts (PWR2).....	51
Table 4-20: Power Connector Pinouts (PWR1).....	51
Table 4-21: RS-232 Serial Port Connector Pinouts (COM1)	51

TANK-820-H61 Embedded System

Table 4-22: RS-232 Serial Port Connector Pinouts (COM2)	52
Table 4-23: RS-232 Serial Port Connector Pinouts (COM3)	52
Table 4-24: RS-232 Serial Port Connector Pinouts (COM4)	52
Table 4-25: RS-232 Serial Port Connector Pinouts (COM7)	52
Table 4-26: RS-232 Serial Port Connector Pinouts (COM8)	53
Table 4-27: RS-422/485 Serial Port Connectors Pinouts (COM5)	53
Table 4-28: RS-422/485 Serial Port Connectors Pinouts (COM6)	53
Table 4-29: USB 3.0 Connectors Pinouts (USB3_12)	54
Table 4-30: VGA Connector Pinouts (VGA1)	54
Table 4-31: Jumper	54
Table 4-32: Clear CMOS Setup Jumper Settings (J_CMOS2)	54
Table 5-1: BIOS Navigation Keys	57

Chapter

1

Introduction

1.1 Overview



Figure 1-1: TANK-820-H61

The TANK-820-H61 is an embedded system for wide range temperature environments. It is powered by the 2nd Generation Intel® Core™ low power desktop processor, uses the Intel® H61 chipset and has 2.0 GB of DDR3 memory on-board. The TANK-820-H61 series includes one VGA port, one DVI-I port, two GbE LAN ports, four USB 2.0 ports, two USB 3.0 ports, six RS-232 connectors and two RS-422/485 connectors.

TANK-820-H61 Embedded System

1.2 Model Variations

The model variations of the TANK-820-H61 series are listed below.

Model No.	Variations	CPU	Expansion Slots
TANK-820-H61	TANK-820-H61-I5/2G/2P1E-R10	Intel® Core™ i5 2xxT	Two PCI slots
	TANK-820-H61-I3/2G/2P1E-R10	Intel® Core™ i3 2xxT	One PCIe x16 slot (PCIe x8 signal)
	TANK-820-H61-P/2G/2P1E-R10	Intel® Pentium® G6xxT	
	TANK-820-H61-I5/2G/1P2E-R10	Intel® Core™ i5 2xxT	One PCI slot
	TANK-820-H61-I3/2G/1P2E-R10	Intel® Core™ i3 2xxT	One PCIe x4 slot (PCIe x1 signal)
	TANK-820-H61-P/2G/1P2E-R10	Intel® Pentium® G6xxT	One PCIe x16 slot (PCIe x8 signal)

Table 1-1: TANK-820-H61 Model Variations

1.3 Features

The TANK-820-H61 features are listed below:

- 2nd Generation Intel® Core™ low power desktop processors for TANK-820
- On-board 2GB DDR3 memory and one DDR3 SO-DIMM slot (system max. 10GB)
- Redundant dual wide range DC power support (9 ~ 24 VDC)
- Flexible PCI/PCIe expansion slots satisfy customized requirements
- Rich I/O functions satisfy various applications
- Dual PCIe GbE LAN for high speed network applications
- One CompactFlash® socket

1.4 Technical Specifications

The TANK-820-H61 technical specifications are listed in **Table 1-2**.

Specifications	
System	
CPU	2nd Generation Intel® Core™ low power desktop processor
Chipset	Intel® H61

Specifications	
Memory	1 x 204-pin DDR3 SDRAM SO-DIMM slot (Max. to 10G) On-board 2GB DDR3 memory
Ethernet Controller	Dual Realtek RTL8111E PCIe GbE controllers with ASF 2.0 support
I/O and Indicators	
Ethernet	2 x RJ-45 GbE ports
RS-232	4 x RS-232 serial ports (DB-9) 2 x RS-232 serial ports (DB-9 with isolation)
RS-422/RS-485	2 x RS-422/485 serial ports (RJ-45)
USB Interfaces	4 x USB 2.0 ports on front side 2 x USB 3.0 ports on rear side
Display	1 x VGA port (2048 x 1536 @ 75Hz) 1 x DVI-I port (1920 x 1080 @ 60Hz)
Audio Connector	1 x Line-out port 1 x Mic-in port
Digital I/O	1 x DB-9 port on rear side
Interior Expansions	Either one PCIe x8 (via PCIe x16 slot) and two PCI or one PCIe x1 (via PCIe x4 slot), one PCIe x8 (via PCIe x16 slot) and one PCI
LED Indicators	AT power mode LED ATX power mode LED CPU temperature alert LED HDD LED Power 1 LED Power 2 LED
Storage	
SATA	2.5" SATA HDD bay
CompactFlash®	One CompactFlash® Type II socket

TANK-820-H61 Embedded System

Specifications	
Power	
Power Supply	Redundant dual DC input Terminal Block: 9 ~ 24V DC Jack: 9 ~ 24V
Power Consumption	19V@3.5A (Intel® Core™ i3-2100 processor with 6GB DDR3 memory) without add-on card
Environmental and Mechanical	
Operating Temperature	-20°C ~ 60°C with air flow
Storage Temperature	-30°C~80°C
Humidity	5% ~ 95%, non-condensing
Mounting	Desktop, wall mount
Color	Black C + Silver
Chassis Construction	Extruded Aluminum Alloy
Physical Dimensions	133 mm x 206 mm x 269 mm (W x H x D)
Operating Shock	Half-sine wave shock 5G, 11ms, 3 axis
Operating Vibration	Meet MIL-STD-810F 514.5C-2 (with SSD)
Weight (Net/Gross)	4.2 Kg / 6.3 Kg
Safety & EMC	CE / FCC

Table 1-2: Technical Specifications

1.5 Front Panel

The front panel of the TANK-820-H61 has the following features (**Figure 1-2**):

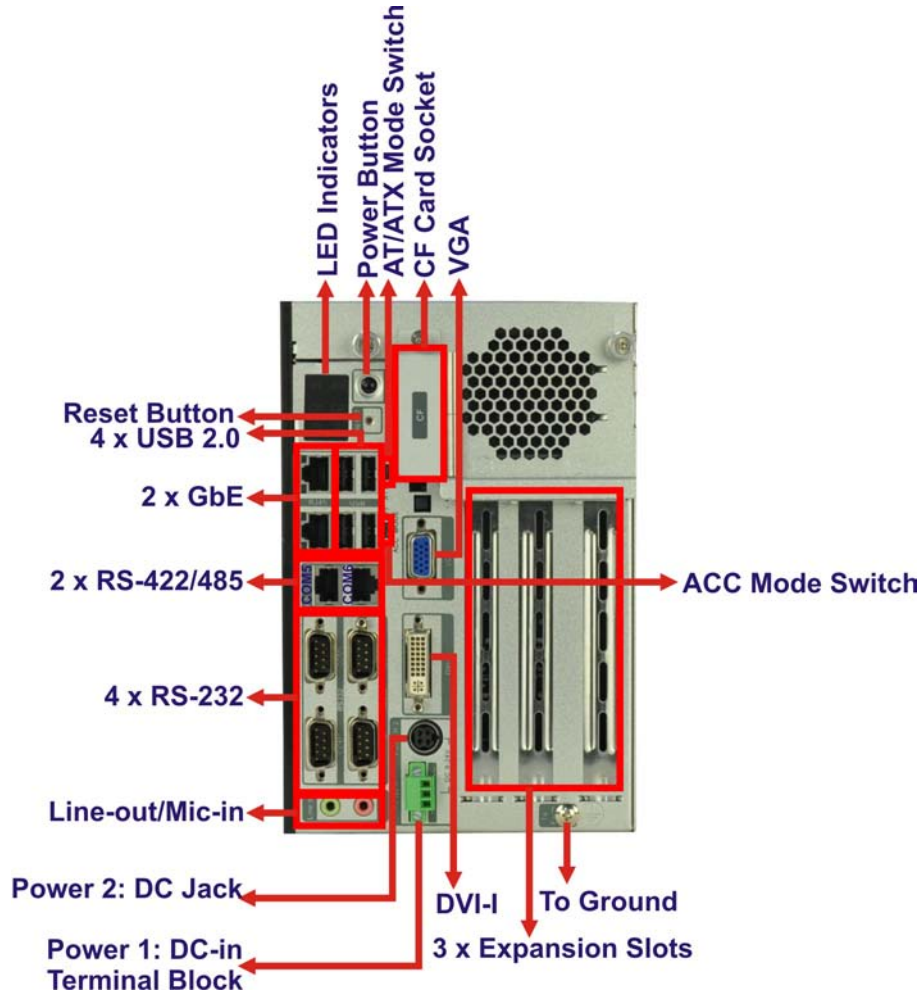

Figure 1-2: TANK-820-H61 Front Panel

Connectors and buttons on the front panel include the following:

- 1 x 4-pin power DC jack for 9 V ~ 24 V power input
- 1 x Power terminal block for 9 V ~ 24 V power input
- 1 x Mic-in port (pink)
- 1 x Line-out port (green)
- 4 x RS-232 serial ports (DB-9)
- 2 x RS-422/485 serial ports (RJ-45)
- 2 x Gigabit Ethernet ports (RJ-45)

TANK-820-H61 Embedded System

- 4 x USB 2.0 ports
- 1 x Reset button
- 6 x LED indicators (**Section 1.7**)
- 1 x Power button
- 1 x CompactFlash® Type II socket
- 1 x VGA port
- 1 X DVI-I port
- 1 x To Ground
- 3 x Expansion slots
- 1 x ACC mode switch
- 1 x AT/ATX mode switch

1.6 Rear Panel

The rear panel of the TANK-820-H61 has the following features (**Figure 1-2**):

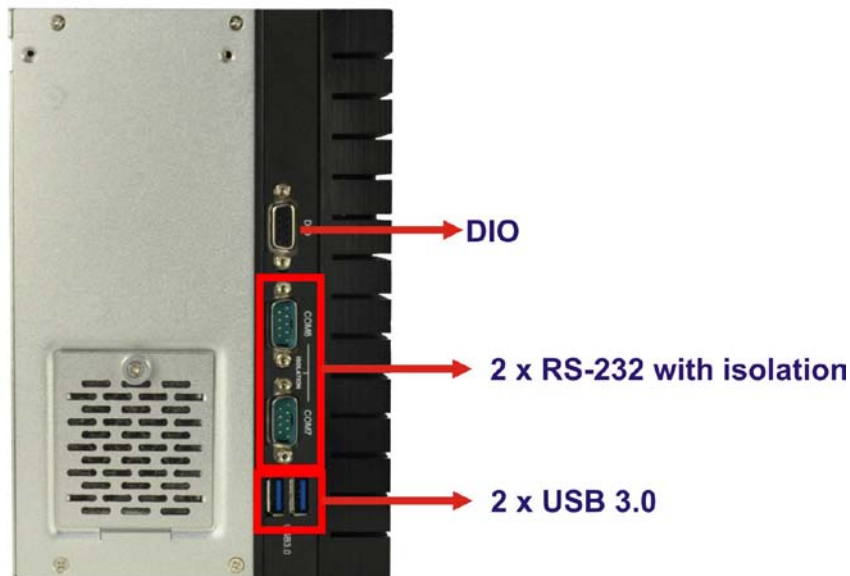

Figure 1-3: TANK-820-H61 Rear Panel

Connectors on the front panel include the following:

- 1 x DIO connector
- 2 x RS-232 serial ports (DB-9 with isolation)
- 2 x USB 3.0 ports

1.7 LED Indicators

There are several indicators on the rear panel of the TANK-820-H61 as shown in **Figure 1-4**.

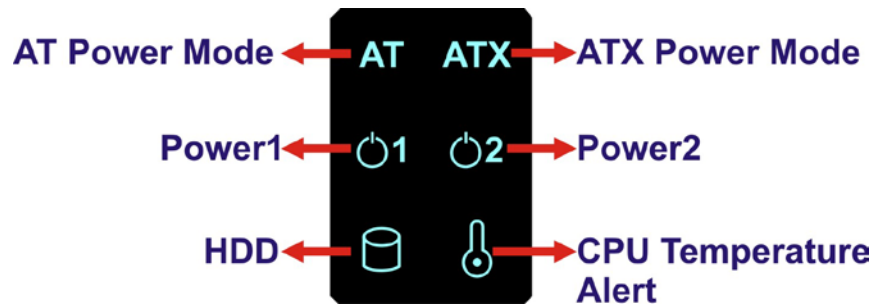

Figure 1-4: TANK-820-H61 LED Indicators

The descriptions of each LED indicator are listed below.

LED Indicator	Description
AT Power Mode	The current power mode status is AT mode. Controlled by the AT/ATX power mode switch.
ATX Power Mode	The current power mode status is ATX mode. Controlled by the AT/ATX power mode switch.
Power 1	Breathing orange: Standby mode.
Power 2	Solid blue: Power-on mode.
HDD	Shows HDD status.
CPU Temperature Alert	BLUE: CPU temperature is normal. RED: CPU temperature is too high.

Table 1-3: LED Indicators Description



WARNING:

The CPU Temperature Alert LED turns red when the CPU temperature is too high. If this situation occurs, lower the environment temperature or close some running applications to cool down the CPU.

TANK-820-H61 Embedded System

1.8 Backplane Options

The backplane options of the TANK-820-H61 are shown below.

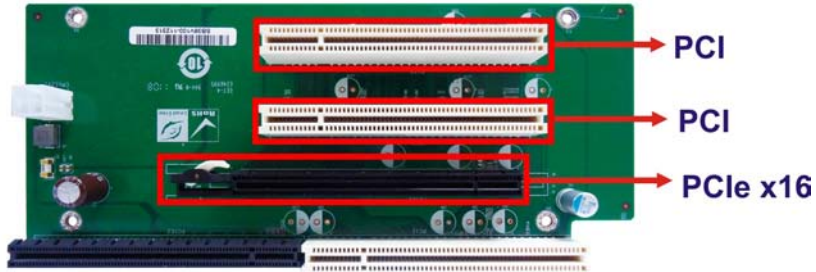

Figure 1-5: HPE-3S6 (2P1E)

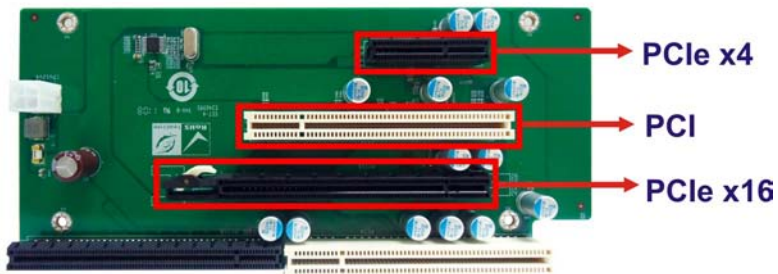

Figure 1-6: HPE-3S7 (1P2E)

The supported signals of the backplane slots are listed below.

Backplane	Slot	Signal
HPE-3S6 (2P1E)	PCI	PCI
	PCIe x16	PCIe x8
HPE-3S7 (1P2E)	PCI	PCI
	PCIe x4	PCIe x1
	PCIe x16	PCIe x8

Table 1-4: Supported Signals

The rated voltage and current of the backplanes are listed below.

Rated Voltage	Rated Current
+5 V	7 A

+12 V	3.75 A
-12 V	0.1 A
+3.3 V	8 A

Table 1-5: Rated Voltage and Current



WARNING:

The system default power is 120 W. The maximum total power of the backplane to support expansion cards is 45 W. The power of the selected expansion cards can not exceed the max. power (45 W), otherwise, the system may be unstable.



NOTE:

When using an expansion card with high power consumption, it is recommended to install an external power supply to the 12V power input connector on the backplane.

The two types of backplane support standard PCI/PCIe cards with maximum dimensions (WxL):110 x 230 mm.

TANK-820-H61 Embedded System

1.9 Dimensions

The physical dimensions are shown below:

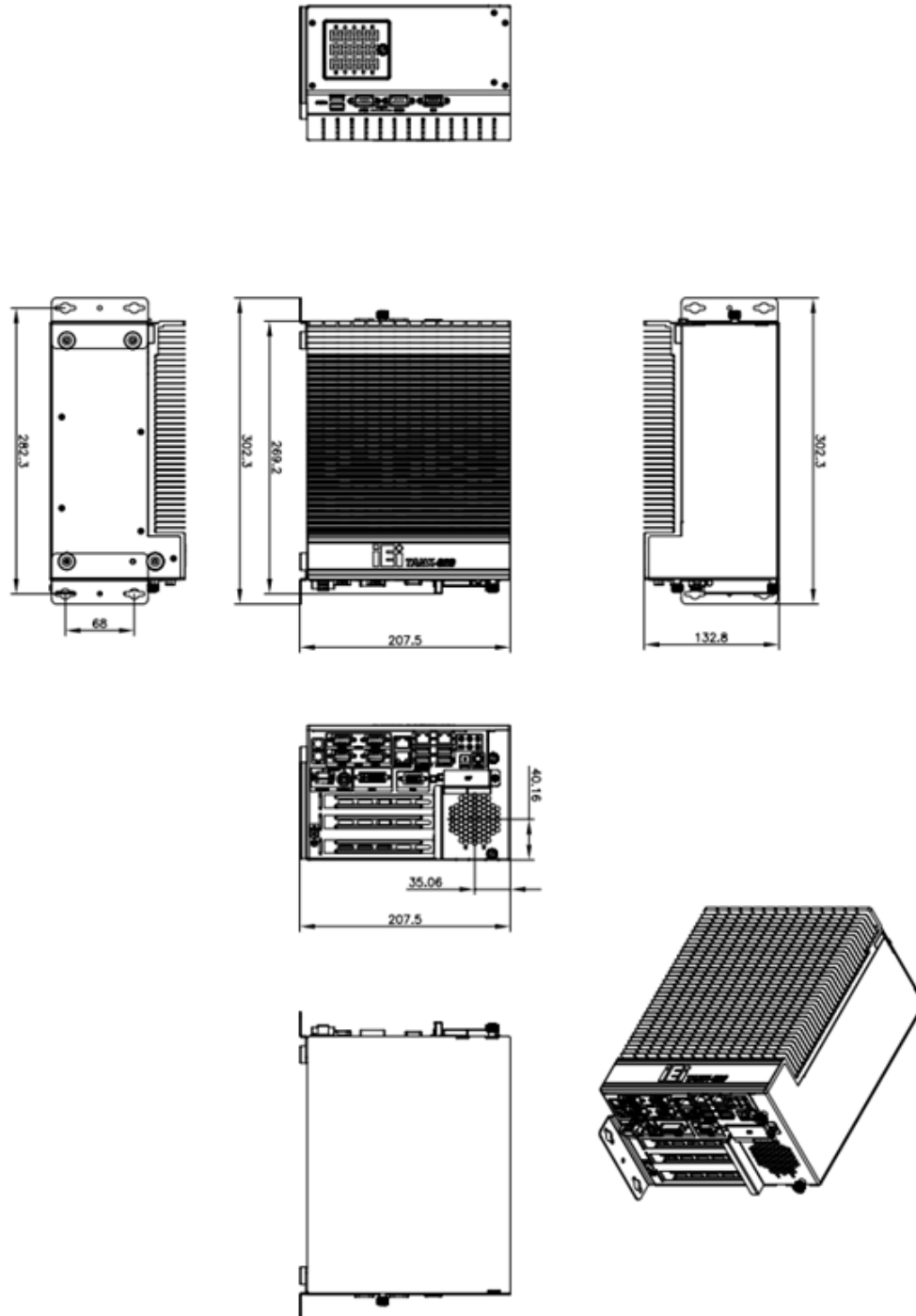

Figure 1-7: Physical Dimensions (millimeters)

Chapter

2

Unpacking

TANK-820-H61 Embedded System

2.1 Anti-static Precautions



WARNING:

Failure to take ESD precautions during installation may result in permanent damage to the TANK-820-H61 and severe injury to the user.

Electrostatic discharge (ESD) can cause serious damage to electronic components, including the TANK-820-H61. Dry climates are especially susceptible to ESD. It is therefore critical that whenever the TANK-820-H61 or any other electrical component is handled, the following anti-static precautions are strictly adhered to.

- **Wear an anti-static wristband:** Wearing a simple anti-static wristband can help to prevent ESD from damaging the board.
- **Self-grounding:** Before handling the board touch any grounded conducting material. During the time the board is handled, frequently touch any conducting materials that are connected to the ground.
- **Use an anti-static pad:** When configuring the TANK-820-H61, place it on an anti-static pad. This reduces the possibility of ESD damaging the TANK-820-H61.

2.2 Unpacking Precautions

When the TANK-820-H61 is unpacked, please do the following:

- Follow the anti-static precautions outlined in **Section 2.1**.
- Make sure the packing box is facing upwards so the TANK-820-H61 does not fall out of the box.
- Make sure all the components shown in **Section 2.3** are present.





2.3 Unpacking Checklist











NOTE:

If some of the components listed in the checklist below are missing, please do not proceed with the installation. Contact the IEI reseller or vendor you purchased the TANK-820-H61 from or contact an IEI sales representative directly. To contact an IEI sales representative, please send an email to sales@iei.com.tw.

The TANK-820-H61 is shipped with the following components:

Quantity	Item and Part Number	Image
Standard		
1	TANK-820-H61	
1	Power Adapter (P/N: 63000-FSP120AAB-RS)	
1	Power Cord (P/N: 32702-000401-100-RS)	
1	Power Transfer Cord (P/N: 32702-000300-100-RS)	
4	Mounting Bracket Screws (P/N: 44033-040062-RS)	

TANK-820-H61 Embedded System

Quantity	Item and Part Number	Image
Standard		
2	Mounting Brackets (P/N: 41020-0366E4-00-RS)	
4	HDD Screws (P/N: 44043-030051-RS)	
4	Rubber Foot Pad Screws (P/N: 44033-040061-RS)	
4	Rubber Foot Pads (P/N: 46015-006300-RS)	
2	RJ-45 to DB-9 COM Port Cable (P/N: 32005-000200-200-RS)	
1	Pluggable DC-in Terminal Block (P/N: 33502-000007-RS)	
1	One Key Recovery CD (P/N: 7B000-000724-RS)	
1	User Manual and Driver CD	
4	Fan Screws (P/N: 44003-030151-RS)	

The following table lists the optional items that can be purchased separately.

Optional	
System Fan (50mmx50mmx15mm) (P/N: 19FR125015BU-000002-RS: For R20 Version, support CPU card: 1.02 version above)	
System Fan (40mmx40mmx10mm) (P/N: 19FR124010BL-000006-RS: For R21 Version, support CPU card: 1.02 version above)	
OS: Win CE 6.0 (128MB CF Card) (P/N: TANKCF-820-H61-CE060-128M-R10)	
OS: Win XPE (4GB CF Card) (P/N: TANKCF-820-H61-XPE-4G-R10)	
OS: Linux (2GB CF Card) (P/N: TANKCF-820-H61-LNX-2G-R10)	
OS: Win 7 Embedded (4GB CF Card) (P/N: TANKCF-820-H61-WES7E-4G-R10)	

Chapter

3

Installation

3.1 Installation Precautions

During installation, be aware of the precautions below:

- **Read the user manual:** The user manual provides a complete description of the TANK-820-H61, installation instructions and configuration options.
- **DANGER! Disconnect Power:** Power to the TANK-820-H61 must be disconnected during the installation process, or before any attempt is made to access the rear panel. Electric shock and personal injury might occur if the rear panel of the TANK-820-H61 is opened while the power cord is still connected to an electrical outlet.
- **Qualified Personnel:** The TANK-820-H61 must be installed and operated only by trained and qualified personnel. Maintenance, upgrades, or repairs may only be carried out by qualified personnel who are familiar with the associated dangers.
- **Air Circulation:** Make sure there is sufficient air circulation when installing the TANK-820-H61. The TANK-820-H61's cooling vents must not be obstructed by any objects. Blocking the vents can cause overheating of the TANK-820-H61. Leave at least 5 cm of clearance around the TANK-820-H61 to prevent overheating.
- **Grounding:** The TANK-820-H61 should be properly grounded. The voltage feeds must not be overloaded. Adjust the cabling and provide external overcharge protection per the electrical values indicated on the label attached to the back of the TANK-820-H61.

3.2 CF Card Installation

To install the CF card, please follow the steps below:

Step 1: Locate the CF card socket, and then loosen the thumbscrew (**Figure 3-1**).

TANK-820-H61 Embedded System



Figure 3-1: CF Card Socket

Step 2: Open the CF card socket cover (**Figure 3-2**).

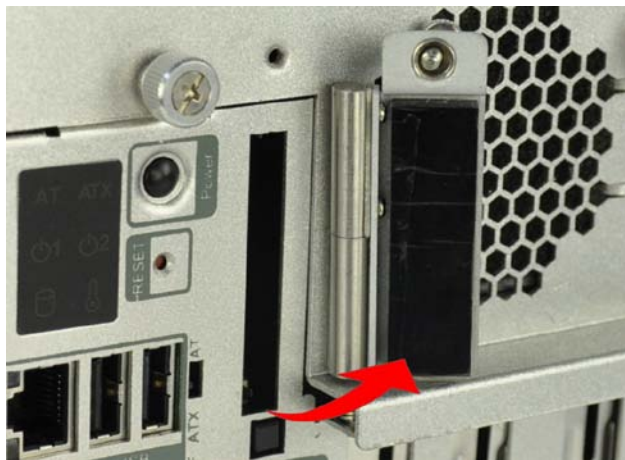

Figure 3-2: CF Card Socket Cover

Step 3: Correctly align the CF card with the socket and insert the CF card into the socket (**Figure 3-3**).



Figure 3-3: CF Card Installation

Step 4: Reinstall the cover.

3.3 Hard Disk Drive (HDD) Installation

To install the hard drive, please follow the steps below:

Step 1: Remove the two retention screws on the rear panel and loosen the two thumbscrews on the front panel, slide the cover inwards, and then lift the cover up gently (**Figure 3-4**).



Figure 3-4: Unscrew the Cover

TANK-820-H61 Embedded System

Step 2: Unplug the SATA signal and power cables connected to the TANK-820-H61, and then put the cover on a flat surface (**Figure 3-5**).

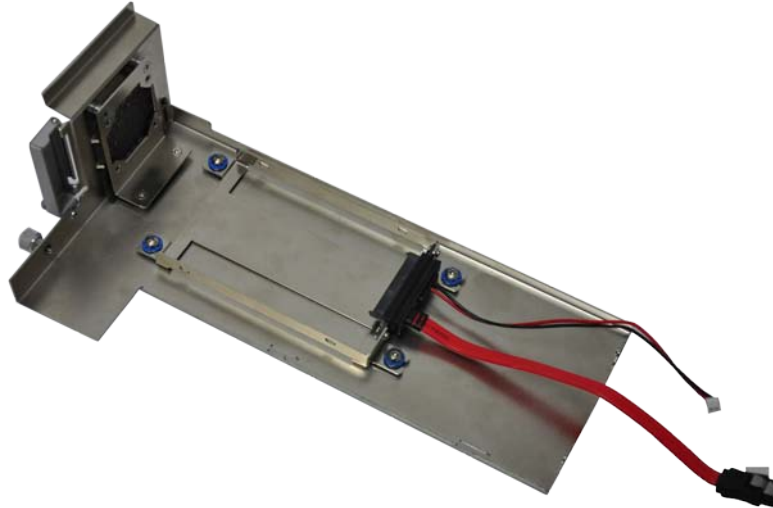

Figure 3-5: Remove the Cover from TANK-820-H61

Step 3: Attach the HDD to the HDD bracket, and then slide the HDD to connect the HDD to the SATA connector (**Figure 3-6**).

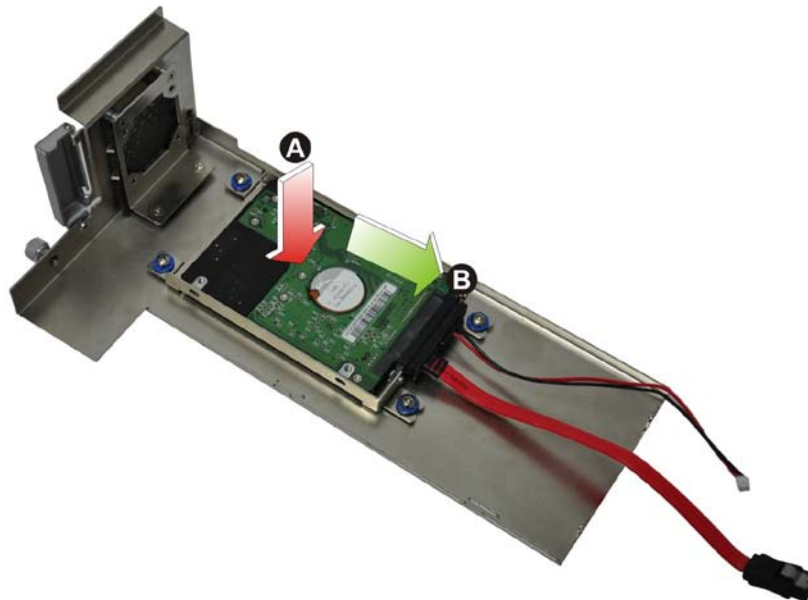

Figure 3-6: HDD Installation

Step 4: Secure the HDD with the HDD bracket by four retention screws (**Figure 3-7**).

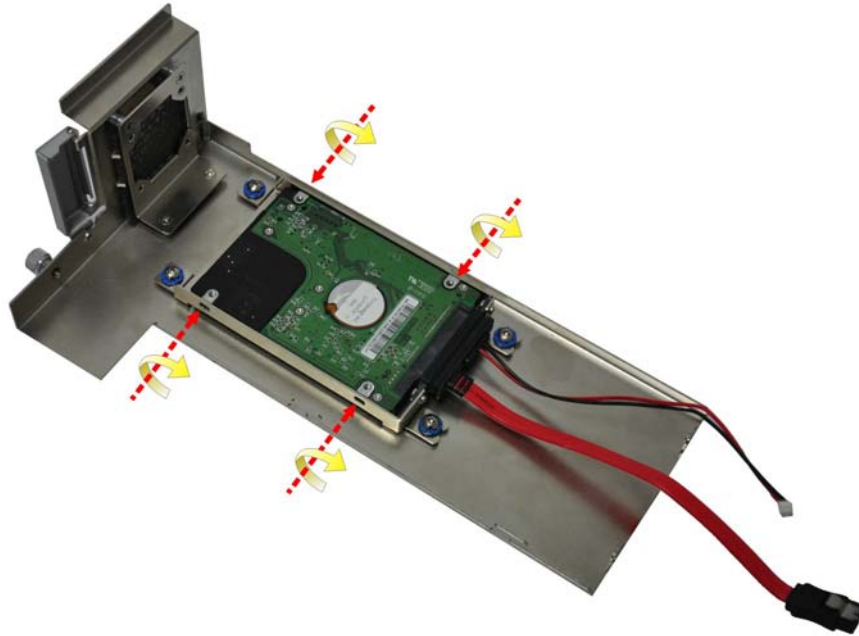

Figure 3-7: HDD Retention Screws

Step 5: Reconnect the SATA signal and power cables to the TANK-820-H61.

Step 6: Reinstall the cover.

3.4 System Fan Installation

To install the optional system fan, please follow the steps below:

Step 1: Remove the two retention screws on the rear panel and loosen the two thumbscrews on the front panel, slide the cover inwards, and then lift the cover up gently (**Figure 3-4**).

Step 2: Unplug the SATA signal and power cables connected to the TANK-820-H61, and then place the cover on a flat surface (**Figure 3-5**).

Step 3: Attach the system fan to the TANK-820-H61 and secure it by four retention screws (**Figure 3-8**).

TANK-820-H61 Embedded System

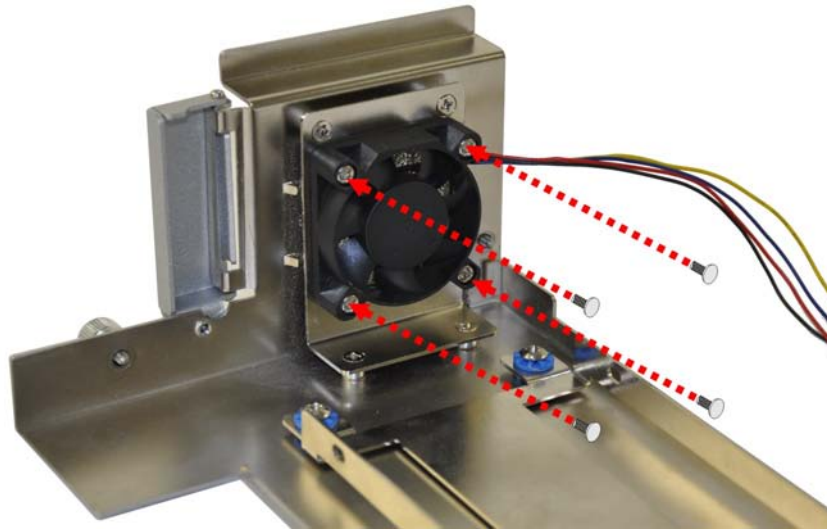

Figure 3-8: System Fan Installation

- Step 4:** Connect the system fan cable to the **CPU_FAN1** connector on the motherboard of TANK-820-H61.
- Step 5:** Reconnect the SATA signal and power cables to the TANK-820-H61.
- Step 6:** Reinstall the cover.

3.5 Mounting the System with Mounting Brackets

To mount the embedded system onto a wall or some other surface using the two mounting brackets, please follow the steps below.

- Step 1:** Turn the embedded system to the left side panel.
- Step 2:** Align the two retention screw holes in each bracket with the corresponding retention screw holes on the bottom surface or the left side panel (**Figure 3-9**).

Left Side Panel



Figure 3-9: Mounting Bracket Retention Screws

- Step 3:** Secure the brackets to the system by inserting two retention screws into each bracket (**Figure 3-9**).
- Step 4:** Drill holes in the intended installation surface.
- Step 5:** Align the mounting holes in the sides of the mounting brackets with the predrilled holes in the mounting surface.
- Step 6:** Insert four retention screws, two in each bracket, to secure the system to the wall.

3.6 Foot Pad Installation

The TANK-820-H61 is shipped with four foot pads. To install the foot pads, follow the instructions below.

- Step 1:** Turn the TANK-820-H61 to the left side panel.
- Step 2:** Locate the four retention screw holes for the foot pad in the bottom surface.
- Step 3:** Align the hole of the foot pad with the retention screw holes on the bottom surface.
- Step 4:** Secure the foot pad to the chassis by inserting the retention screw.

TANK-820-H61 Embedded System



Figure 3-10: Foot Pad Installation

3.7 External Peripheral Interface Connectors

The TANK-820-H61 has the following connectors. Detailed descriptions of the connectors can be found in the subsections below.

- ACC mode switch
- AT/ATX power mode switch
- Audio
- CompactFlash® Type II
- DIO
- DVI-I
- Ethernet
- Power button
- Power DC jack
- Power terminal block
- Reset button
- RS-232

- RS-422/485
- USB
- VGA

3.7.1 ACC Mode Selection

The TANK-820-H61 allows turning the ACC mode on or off. The setting can be made through the ACC mode switch on the external peripheral interface panel as shown below.

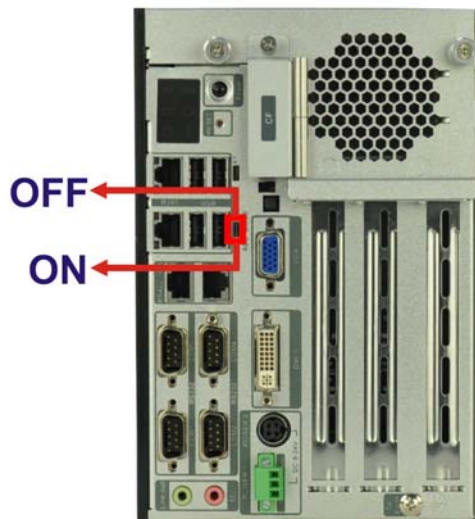

Figure 3-11: ACC Mode Switch

3.7.2 AT/ATX Power Mode Selection

The TANK-820-H61 supports AT and ATX power modes. The setting can be made through the AT/ATX power mode switch on the external peripheral interface panel as shown below.

TANK-820-H61 Embedded System

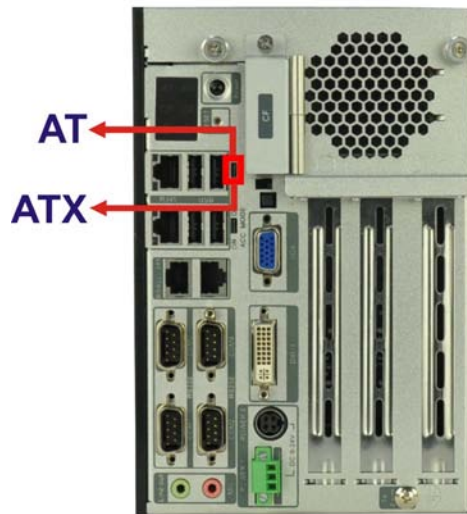

Figure 3-12: AT/ATX Power Mode Switch

3.7.3 Audio Connector

The audio jacks connect to external audio devices.

- **Line Out port (Green):** Connects to a headphone or a speaker. With multi-channel configurations, this port can also connect to front speakers.
- **Microphone (Pink):** Connects a microphone.



Figure 3-13: Audio Connector

3.7.4 CompactFlash® Type II

The TANK-820-H61 has one CF Type II socket. The location of the socket is shown in **Figure 1-2**. To install the CF card, refer to **Section 3.2**.

3.7.5 Digital Input/Output Connector

The digital I/O connector provides programmable input and output for external devices. The pinouts for the digital I/O connector are listed in the table below.

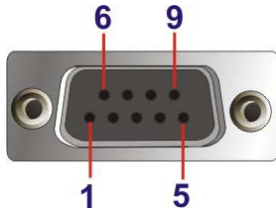

Figure 3-14: DIO Connector

3.7.6 DVI Connector

The TANK-820-H61 has one female DVI-I connector on the front panel. The DVI connectors are connected to digital display devices. To connect a digital display device to the TANK-820-H61, please follow the instructions below.

- Step 1:** **Locate the DVI connector.** The location of the DVI connector is shown in **Chapter 1**.
- Step 2:** **Align the DVI connector.** Align the male DVI connector on the digital display device cable with the female DVI connector on the external peripheral interface.
- Step 3:** **Insert the DVI connector.** Once the connectors are properly aligned with the male connector, insert the male connector from the digital display device into the female connector on the TANK-820-H61. See **Figure 3-15**.

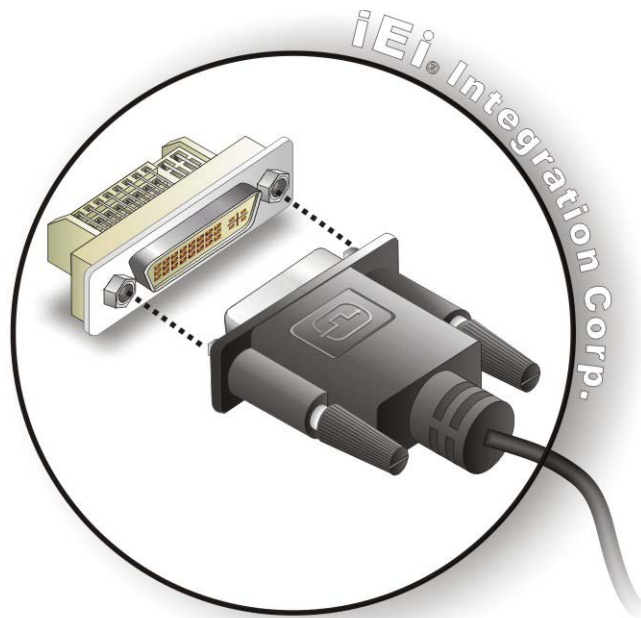

Figure 3-15: DVI Connector

- Step 4: Secure the connector.** Secure the DVI connector from the digital display device to the external interface by tightening the two retention screws on either side of the connector.

3.7.7 LAN Connectors

The LAN connectors allow connection to an external network.

- Step 1: Locate the RJ-45 connectors.** The locations of the RJ-45 connectors are shown in **Figure 1-2**.
- Step 2: Align the connectors.** Align the RJ-45 connector on the LAN cable with one of the RJ-45 connectors on the TANK-820-H61. See **Figure 3-16**.

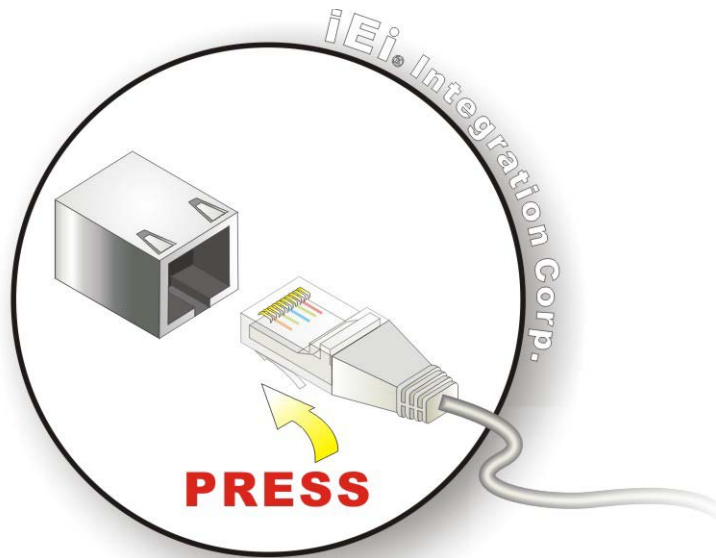

Figure 3-16: LAN Connection

Step 3: Insert the LAN cable RJ-45 connector. Once aligned, gently insert the LAN cable RJ-45 connector into the on-board RJ-45 connector.



Figure 3-17: RJ-45 Ethernet Connector

The RJ-45 Ethernet connector has two status LEDs, one green and one yellow. The green LED indicates activity on the port and the yellow LED indicates the port is linked. See **Table 3-1**.

Activity/Link LED		Speed LED	
STATUS	DESCRIPTION	STATUS	DESCRIPTION
Off	No link	Off	10 Mbps connection
Yellow	Linked	Green	100 Mbps connection
Blinking	TX/RX activity	Orange	1 Gbps connection

Table 3-1: RJ-45 Ethernet Connector LEDs

TANK-820-H61 Embedded System

3.7.8 Power Input, 3-pin Terminal Block

The power connector connects the leads of a 9 V~24 V DC power supply into the terminal block. Make sure that the power and ground wires are attached to the correct sockets of the connector.

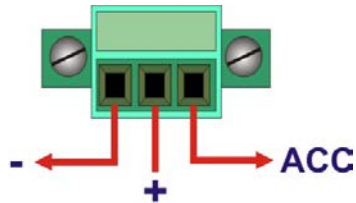

Figure 3-18: 3-pin Terminal Block

3.7.9 Power Input, 4-pin DIN Connector

The power connector connects to the 9 V~24 V DC power adapter.

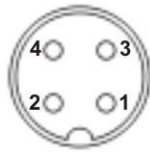

Figure 3-19: Power Input Connector

3.7.10 RJ-45 RS-422/485 Serial Ports

RS-422/485 serial port devices can be attached to the RJ-45 RS-422/485 serial ports on the rear panel.

Step 1: Locate the RJ-45 RS-422/RS485 connectors. The locations of the RJ-45 RS-422/RS-485 connectors are shown in **Figure 1-2**.

Step 2: Insert the RJ-45 connector. Insert the RJ-45 connector on the RJ-45 to DB-9 COM port cable to one of the RJ-45 RS-422/485 connectors on the TANK-820-H61. See **Figure 3-20**.

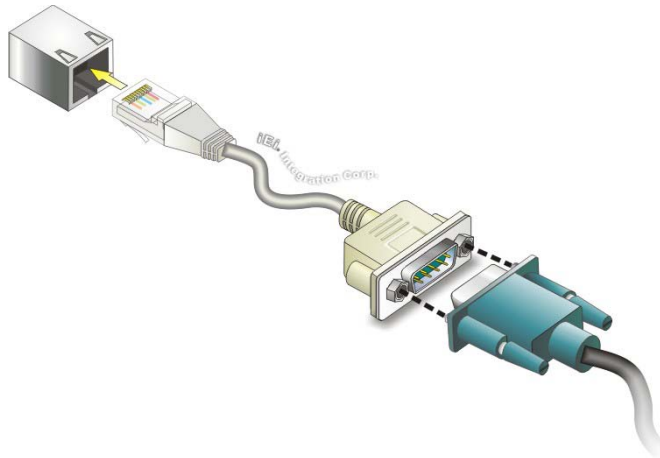

Figure 3-20: RJ-45 RS-422/485 Serial Device Connection

- Step 3: Insert the serial connector.** Insert the DB-9 connector of a serial device into the DB-9 connector on the RJ-45 to DB-9 COM port cable.
- Step 4: Secure the connector.** Secure the serial device connector to the external interface by tightening the two retention screws on either side of the connector.

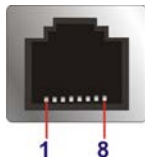

Figure 3-21: RJ-45 RS-422/485 Serial Port Connector

Pin	Description (RS-422)	Description (RS-485)
1	N/A	N/A
2	TXD422#	TXD485#
3	N/A	N/A
4	TXD422+	TXD485+
5	GND	GND
6	RXD422#	N/A
7	N/A	N/A
8	RXD422+	N/A

Table 3-2: RJ-45 RS-422/485 Serial Port Pinouts

TANK-820-H61 Embedded System

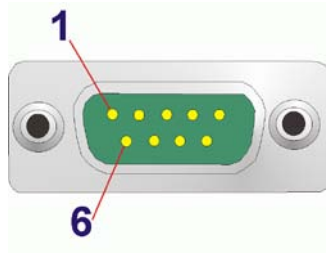

Figure 3-22: DB-9 Connector Pinout Location

Pin	Description (RS-422)	Description (RS-485)
1	RXD422+	N/A
2	RXD422#	N/A
3	TXD422+	TXD485+
4	TXD422#	TXD485#
5	GND	GND
6	N/A	N/A
7	N/A	N/A
8	N/A	N/A
9	N/A	N/A

Table 3-3: DB-9 Connector Pinouts

3.7.11 RS-232 Serial Port Connectors

RS-232 serial port devices can be attached to the DB-9 ports on the rear panel.

Step 1: **Locate the DB-9 connector.** The locations of the DB-9 connectors are shown in **Figure 1-2**.

Step 2: **Insert the serial connector.** Insert the DB-9 connector of a serial device into the DB-9 connector on the external peripheral interface. See **Figure 3-23**.

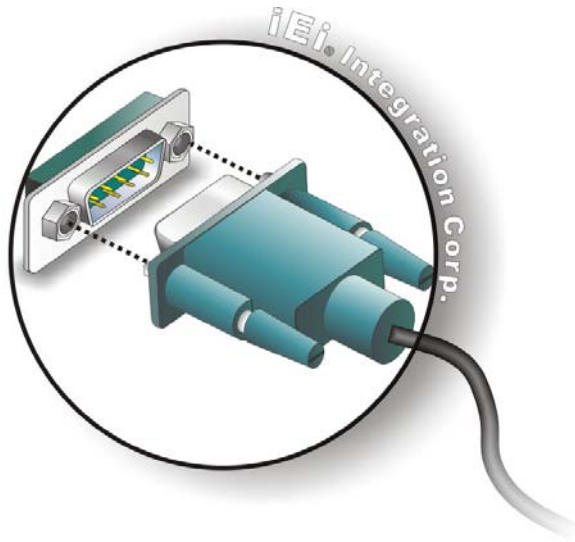

Figure 3-23: Serial Device Connector

Step 3: Secure the connector. Secure the serial device connector to the external interface by tightening the two retention screws on either side of the connector.

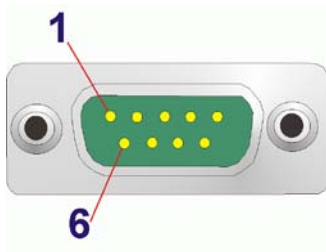

Figure 3-24: DB-9 RS-232 Serial Port Connector

3.7.12 USB Connectors

The USB ports are for connecting USB peripheral devices to the system.

Step 1: Locate the USB connectors. The locations of the USB connectors are shown in **Figure 1-2**.

Step 2: Align the connectors. Align the USB device connector with one of the connectors. See **Figure 3-25**.

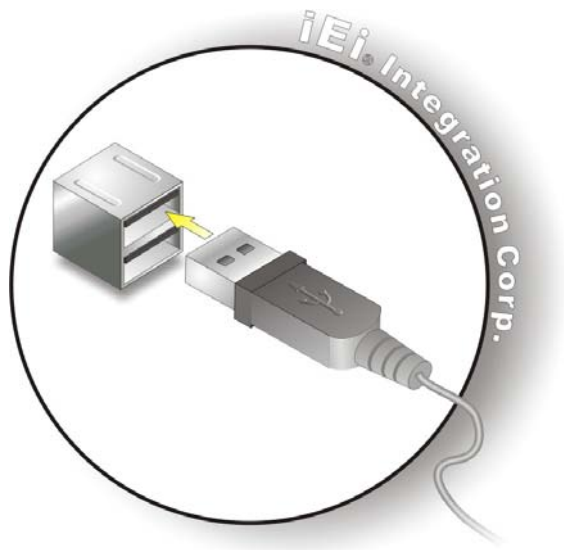

Figure 3-25: USB Device Connection

Step 3: **Insert the device connector.** Once aligned, gently insert the USB device connector into the on-board connector.

3.7.13 VGA Connector

The VGA connector connects to a monitor that accepts VGA video input.

- Step 1:** **Locate the female DB-15 connector.** The location of the female DB-15 connector is shown in **Figure 1-2**.
- Step 2:** **Align the VGA connector.** Align the male DB-15 connector on the VGA screen cable with the female DB-15 connector on the external peripheral interface.
- Step 3:** **Insert the VGA connector** Once the connectors are properly aligned with, insert the male connector from the VGA screen into the female connector on the TANK-820-H61. See **Figure 3-26**.

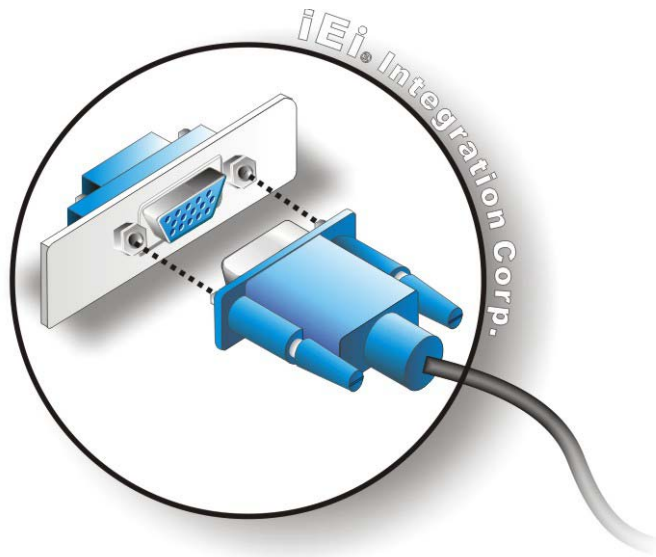

Figure 3-26: VGA Connector

Step 4: Secure the connector. Secure the DB-15 VGA connector from the VGA monitor to the external interface by tightening the two retention screws on either side of the connector.

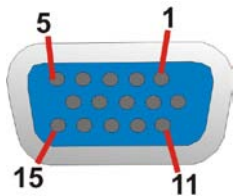

Figure 3-27: VGA Connector

3.8 Powering On/Off the System



WARNING:

Make sure a power supply with the correct input voltage is being fed into the system. Incorrect voltages applied to the system may cause damage to the internal electronic components and may also cause injury to the user.

TANK-820-H61 Embedded System

- **Power on** the system: press the power button for 3 seconds
- **Power off** the system: press the power button for 6 seconds



Figure 3-28: Power Button

3.9 Power

The TANK-820-H61 embedded system supports single DC power input mode, but can be simultaneously connected to two power sources. When both power connectors are connected to power sources, prior to use the corresponding power supply which with higher voltage.

There are two power connectors on the rear panel. Power 1 connector is a 3-pin terminal block that supports ACC On signal. Power 2 connector is a DIN connector that can directly connect to a power adapter. The supported power input voltages are:

- **Power 1 (terminal block):** 9 V~ 24 V
- **Power 2 (DC jack):** 9 V ~ 24 V

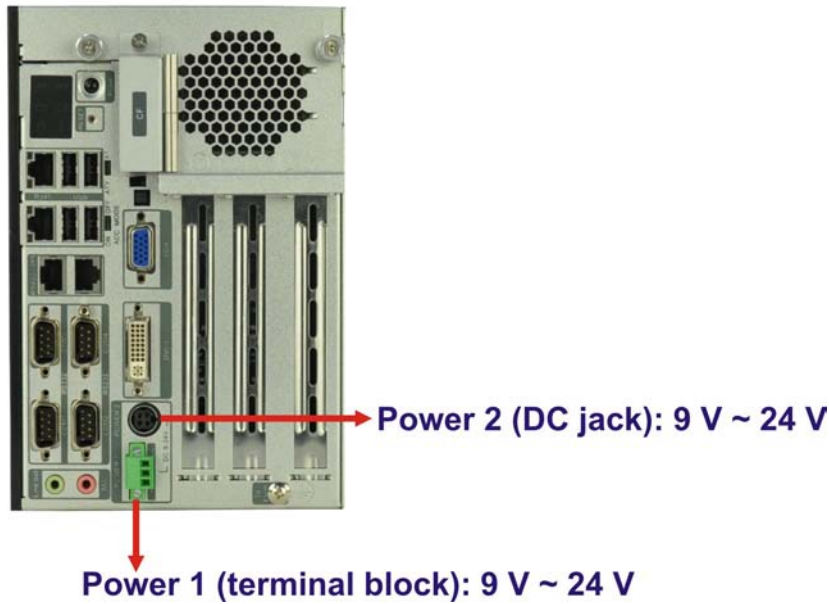

Figure 3-29: Power Connectors

LED Indicator	Description
Power 1	Breathing Orange: Standby mode.
Power 2	Solid blue: Power-on mode.

Table 3-4: Power LED Indicators Description

3.9.1 ACC ON



NOTE:

In ACC On mode, the Power 1 connector must connect to ACC on signal to be able to control the system power.

The ACC On mode is designed for vehicle applications.

3.9.1.1 Boot-up

When both power connectors are connected to power source with over 9 V power input, the two power LEDs on the front panel remain off until **the ACC ON signal jump from**

TANK-820-H61 Embedded System

low to high. The system will detect the Power1 and Power2 voltages and prior to use the corresponding power supply which with higher voltage. The user can choose to use AT power mode or ATX power mode to control the system. The following flow diagrams show the boot-up process and the LED status in AT and ATX power modes.

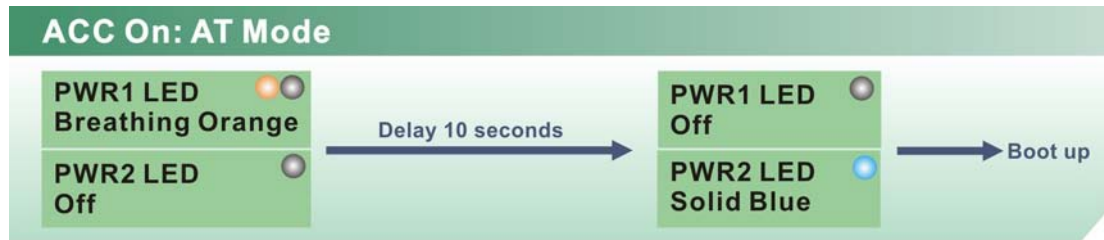

Figure 3-30: ACC On: AT Mode

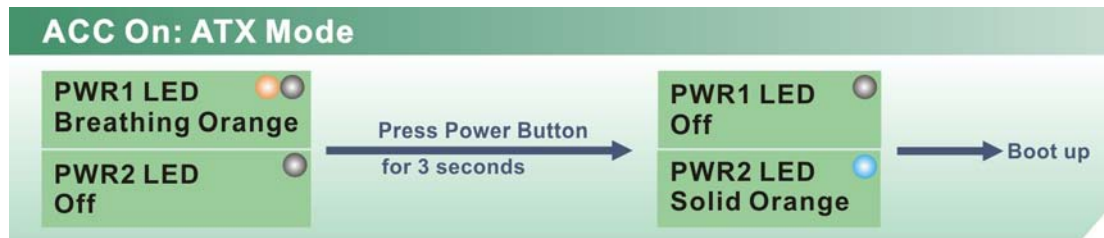

Figure 3-31: ACC On: ATX Mode

3.9.1.2 Shutdown

The system will shutdown in the following situations:

- Power 1 < 9 V and Power 2 < 9 V
- ACC ON signal jump from high to low
- Press Power button for 6 seconds

The following flow diagram shows the system shutdown process and the LED statuses.

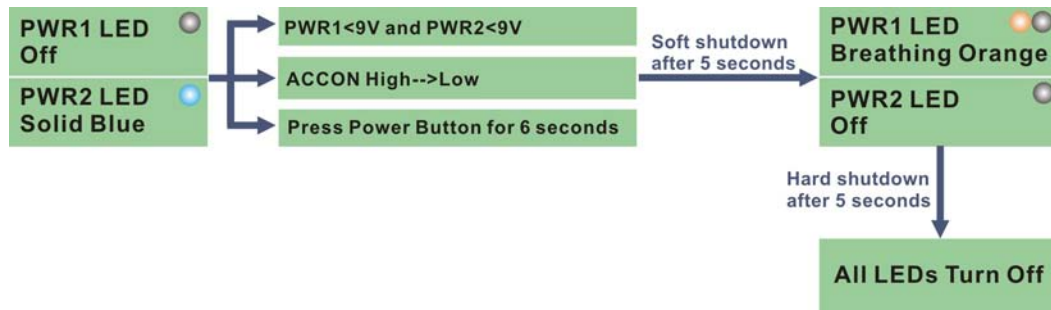

Figure 3-32: ACC On: Shutdown



NOTE:

To turn on the system in the ATX power mode, press the Power button for three seconds. Press the Power button for six seconds to turn off the system.

3.9.2 ACC OFF

When the TANK-820-H61 is in the ACC Off mode, the system does not require an external ACC on signal.

3.9.2.1 Boot-up

When both power connectors are connected to power source with over 9 V power input, the Power 1 LED blinks breathing orange and the Power 2 LED shows off. The user can choose to use AT power mode or ATX power mode to control the system. The following flow diagrams show the boot-up process and the LED status in AT and ATX power modes.

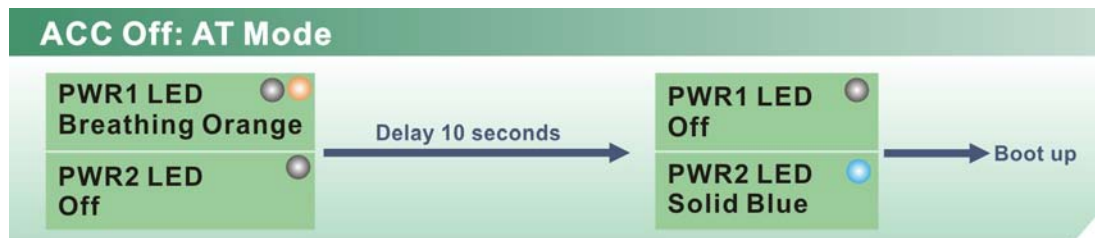

Figure 3-33: ACC Off: AT Mode

TANK-820-H61 Embedded System

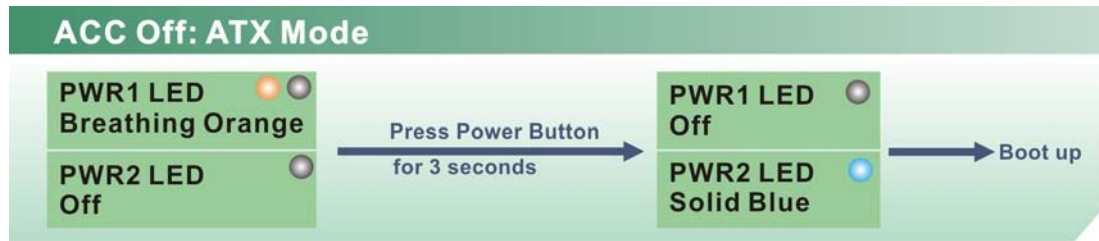

Figure 3-34: ACC Off: ATX Mode

3.9.2.2 Shutdown

The system will shutdown in the following situations:

- Power 1 < 9 V and Power 2 < 9 V
- Press Power buttons for 6 seconds

The following flow diagram shows the system shutdown process and the LED statuses.

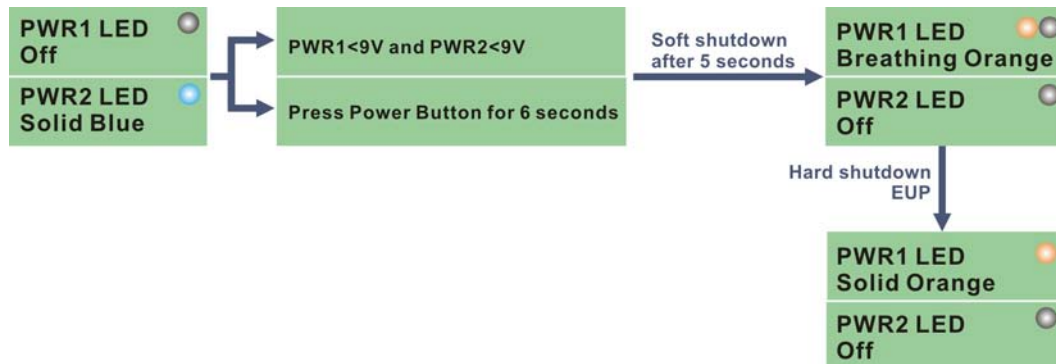

Figure 3-35: ACC Off: Shutdown



NOTE:

The power LED turns off when the power cable is unplugged from the system.

Chapter

4

System Motherboard

TANK-820-H61 Embedded System

4.1 Overview

This chapter details all the jumpers and connectors of the system motherboard.

4.1.1 Layout

The figures below show all the connectors and jumpers of the system motherboard. The Pin 1 locations of the on-board connectors are also indicated in the diagram below.

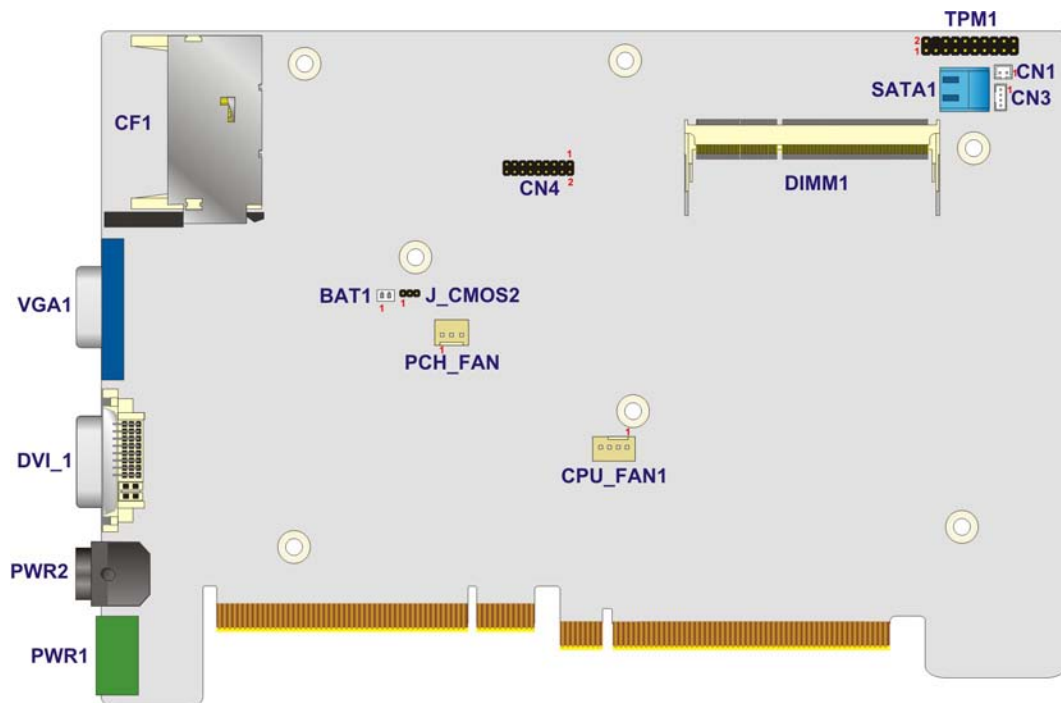

Figure 4-1: System Motherboard (Front)

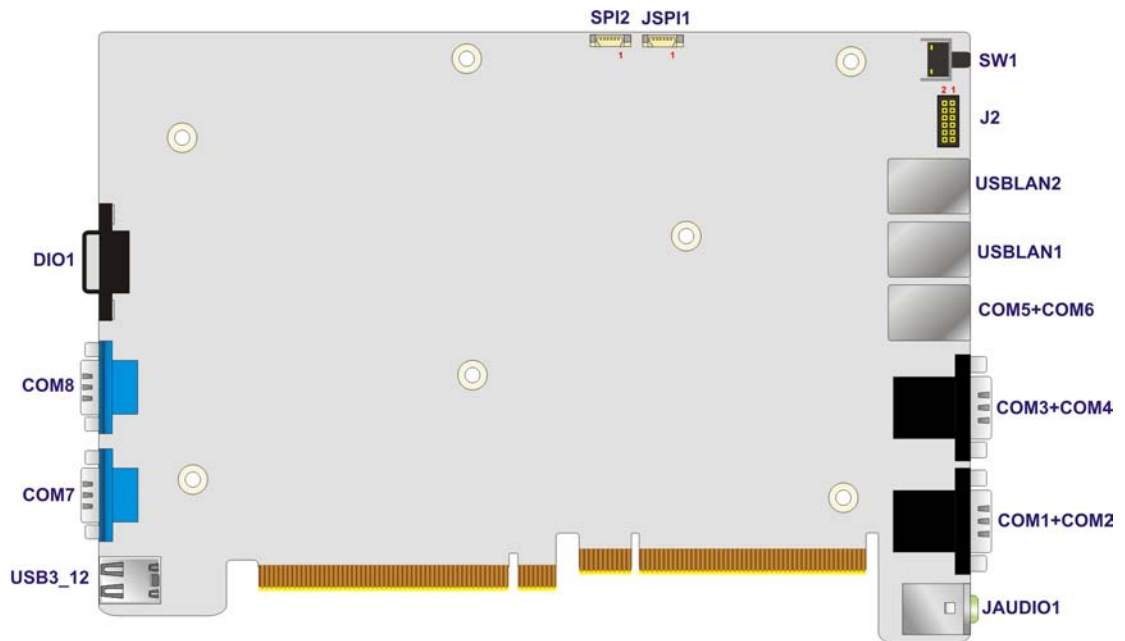

Figure 4-2: System Motherboard (Rear)

4.2 Internal Peripheral Connectors

The table below shows a list of the internal peripheral interface connectors on the system motherboard. Pinouts of these connectors can be found in the following sections.

Connector	Type	Label
Battery connector	2-pin wafer	BAT1
BIOS programming connector	6-pin wafer	SPI2
CompactFlash® Type II socket	CompactFlash® Type II socket	CF1
CPU fan connector	4-pin wafer	CPU_FAN1
DDR3 SO-DIMM slot	DDR3 SO-DIMM slot	DIMM1
EC debug connector	18-pin header	CN4
EC programming connector	6-pin wafer	JSPI1
LED connector	12-pin header	J2
PCH fan connector	3-pin wafer	PCH_FAN
SATA 3Gb/s drive connectors	14-pin SATA connector	SATA1

TANK-820-H61 Embedded System

Connector	Type	Label
SATA power connector	2-pin wafer	CN1
SMBus connector	4-pin wafer	CN3
TPM connector	20-pin header	TPM1

Table 4-1: Peripheral Interface Connectors

4.2.1 Battery Connector (BAT1)

PIN NO.	DESCRIPTION
1	VBATT
2	GND

Table 4-2: Battery Connector Pinouts (BAT1)

4.2.2 BIOS Programming Connector (SPI2)

PIN NO.	DESCRIPTION	PIN NO.	DESCRIPTION
1	+SPI_VCC	2	SPI_CS#0_CN
3	SPI_S00_CN	4	SPI_CLK0_CN
5	SPI_S10_CN	6	GND

Table 4-3: BIOS Programming Connector Pinouts (SPI2)

4.2.3 CPU Fan Connector (CPU_FAN1)

PIN NO.	DESCRIPTION	PIN NO.	DESCRIPTION
1	GND	2	VCC
3	FANPWM1	4	FANIN1

Table 4-4: CPU Fan Connector Pinouts (CPU_FAN1)

4.2.4 EC Debug Connector (CN4)

PIN NO.	DESCRIPTION	PIN NO.	DESCRIPTION
1	EC_EPP_STB#	2	EC_EPP_AFD#
3	EC_EPP_PDO	4	EC_EPP_ERR#

5	EC_EPP_PD1	6	EC_EPP_INIT#
7	EC_EPP_PD2	8	EC_EPP_SLIN#
9	EC_EPP_PD3	10	GND
11	EC_EPP_PD4	12	EC_EPP_ACK#
13	EC_EPP_PD5	14	EC_EPP_BUSY
15	EC_EPP_PD6	16	EC_EPP_PE
17	EC_EPP_PD7	18	EC_EPP_SLCT

Table 4-5: EC Debug Connector Pinouts (CN4)

4.2.5 EC Programming Connector (JSPI1)

PIN NO.	DESCRIPTION	PIN NO.	DESCRIPTION
1	+V3.3A_EC_CONN	2	FSCE#_S
3	FMISO_S	4	FSCK_S
5	FMOSI_S	6	GND

Table 4-6: EC Programming Connector Pinouts (JSPI1)

4.2.6 LED Connector (J2)

PIN NO.	DESCRIPTION	PIN NO.	DESCRIPTION
1	VCC3_IO	2	ISBAT_ORANGE#
3	ICPU_LED02#	4	+V3.3A_EC_IO
5	ICPU_LED01#	6	IDISKLED-
7	IPWRLED02#	8	IATX_LED#
9	IPWRLED01#	10	IAT_LED#
11	IRST_PD#	12	IMPWR_ORANGE#

Table 4-7: LED Connector Pinouts (J2)

4.2.7 PCH Fan Connector (PCH_FAN)

PIN NO.	DESCRIPTION	PIN NO.	DESCRIPTION
1	GND	2	FANOUT2
3	FANIO2		

Table 4-8: PCH Fan Connector Pinouts (PCH_FAN)

4.2.8 SATA 3Gb/s Drive Connectors (SATA1)

PIN NO.	DESCRIPTION	PIN NO.	DESCRIPTION
1	GND	2	SATA20_PTX_C_DRX_P2
3	SATA20_PTX_C_DRX_N2	4	GND
5	SATA20_PRX_C_DTX_N2	6	SATA20_PRX_C_DTX_P2
7	GND	8	GND
9	SATA20_PTX_C_DRX_P3	10	SATA20_PTX_C_DRX_N3
11	GND	12	SATA20_PRX_C_DTX_N3
13	SATA20_PRX_C_DTX_P3	14	GND

Table 4-9: SATA 3Gb/s Drive Connectors Pinouts (SATA1)

4.2.9 SATA Power Connector (CN1)

PIN NO.	DESCRIPTION
1	VCC5
2	GND

Table 4-10: SATA Power Connector Pinouts (CN1)

4.2.10 SMBus Connector (CN3)

PIN NO.	DESCRIPTION	PIN NO.	DESCRIPTION
1	GND	2	SMBDATA_MAIN
3	SMBCLK_MAIN	4	+V5S

Table 4-11: SMBus Connector Pinouts (CN3)

4.2.11 TPM Connector (TPM1)

PIN NO.	DESCRIPTION	PIN NO.	DESCRIPTION
1	TPMPCLK	2	GND
3	LPC_FRAME#	4	NC
5	BUF_PLT_RST#	6	+V5S

7	LPC_AD3	8	LPC_AD2
9	+V3.3S	10	LPC_AD1
11	LPC_AD0	12	GND
13	SMBCLK_MAIN	14	SMBDATA_MAIN
15	+V3.3A	16	INT_SERIRQ
17	GND	18	PM_CLKRUN#
19	PM_SUS_STAT#	20	SIO_DRQ#0

Table 4-12: TPM Connector Pinouts (TPM1)

4.3 External Interface Panel Connectors

The table below shows a list of the external interface panel connectors on the system motherboard. Pinouts of these connectors can be found in the following sections.

Connector	Type	Label
Audio jack (mic, line-out)	Audio jack	JAUDIO1
DIO connector	DB-9	DIO1
DVI connector	24-pin female	DVI_1
Ethernet and USB2.0 connectors	RJ-45, USB 2.0 port	USBLAN1, USBLAN2
Power connector	4-pin DC jack	PWR2
Power connector	3-pin terminal block	PWR1
RS-232 serial port connectors	DB-9	COM1,COM2, COM3,COM4, COM7,COM8
RS-422/485 serial port connectors	Dual RJ-45	COM5, COM6
USB 3.0 connectors	USB 3.0 port	USB3_12
VGA connector	DB-15	VGA1

Table 4-13: Rear Panel Connectors

4.3.1 Audio Jack (J AUDIO1)

PIN NO.	DESCRIPTION	PIN NO.	DESCRIPTION
1	GND	2	ILMIC1-L
3	GND	4	IMIC1_JD
5	ILMIC1-R	22	ILINE_OUTL
23	GND	24	ISPK_JD
25	ILINE_OUTR		

Table 4-14: Audio Jack Pinouts (AUDIO1)

4.3.2 DIO connector (DIO1)

PIN NO.	DESCRIPTION	PIN NO.	DESCRIPTION
1	DIN1	2	DOUT1
3	DIN2	4	DOUT2
5	DIN3	6	DOUT3
7	DIN4	8	DOUT4
9	VCC5		

Table 4-15: DIO connector Pinouts (DIO1)

4.3.3 DVI Connector (DVI_1)

PIN NO.	DESCRIPTION	PIN NO.	DESCRIPTION
1	DVI_TMDS_C_DATA2#	2	DVI_TMDS_C_DATA2
3	GND	4	NC
5	NC	6	DVI_VGA_DDC_SCLK
7	DVI_VGA_DDC_SDATA	8	VSYNC-2
9	DVI_TMDS_C_DATA1#	10	DVI_TMDS_C_DATA1
11	GND	12	NC
13	NC	14	VCC
15	GND	16	DVI_HPD
17	DVI_TMDS_C_DATA0#	18	DVI_TMDS_C_DATA0
19	GND	20	NC
21	NC	22	GND

23	DVI_TMDS_C_CLK	24	DVI_TMDS_C_CLK#
25	GND	26	GND
C1	BR-2	C2	BG-2
C3	BB-2	C4	HSYNC-2
C5	GND		

Table 4-16: DVI Connector Pinouts (DVI_1)

4.3.4 Ethernet and USB2.0 Connectors (USBLAN1)

PIN NO.	DESCRIPTION	PIN NO.	DESCRIPTION
P1	NC	P2	ILAN1_MDIO+
P 3	ILAN1_MDIO-	P 4	ILAN1_MDI1+
P 5	ILAN1_MDI1-	P 6	ILAN1_MDI2+
P 7	ILAN1_MDI2-	P 8	ILAN1_MDI3+
P 9	ILAN1_MDI3-	P 1 0	GND
P 11	ILAN1_LINK100	P 12	ILAN1_LINK1000
P 13	ILAN1_ACT-1	P 14	ILAN1_P
1	IUSBV1L	2	IDATA0_N
3	IDATA0_P	4	GND
5	IUSBV1L	6	IDATA1_N
7	IDATA1_P	8	GND

Table 4-17: Ethernet and USB2.0 Connectors Pinouts (USBLAN1)

4.3.5 Ethernet and USB2.0 Connectors (USBLAN2)

PIN NO.	DESCRIPTION	PIN NO.	DESCRIPTION
P1	NC	P2	ILAN2_MDIO+
P 3	ILAN2_MDIO-	P 4	ILAN2_MDI1+
P 5	ILAN2_MDI1-	P 6	ILAN2_MDI2+
P 7	ILAN2_MDI2-	P 8	ILAN2_MDI3+
P 9	ILAN2_MDI3-	P 1 0	GND
P 11	ILAN2_LINK100	P 12	ILAN2_LINK1000
P 13	ILAN2_ACT-1	P 14	ILAN2_P
1	IUSBV2L	2	IDATA2_N

TANK-820-H61 Embedded System

3	IDATA2_P	4	GND
5	IUSBV2L	6	IDATA3_N
7	IDATA3_P	8	GND

Table 4-18: Ethernet and USB2.0 Connectors Pinouts (USBLAN2)

4.3.6 Power Connector (PWR2)

PIN NO.	DESCRIPTION	PIN NO.	DESCRIPTION
1	VCC	2	GND
3	VCC	4	GND
5	GND		

Table 4-19: Power Connector Pinouts (PWR2)

4.3.7 Power Connector (PWR1)

PIN NO.	DESCRIPTION	PIN NO.	DESCRIPTION
1	ACCON	2	VCC
3	GND		

Table 4-20: Power Connector Pinouts (PWR1)

4.3.8 RS-232 Serial Port Connector (COM1)

PIN NO.	DESCRIPTION	PIN NO.	DESCRIPTION
1	INDCD1	2	INRX1
3	INTX1	4	INDTR1
5	GND	6	INDSR1
7	INRTS1	8	INCTS1
9	INRI1		

Table 4-21: RS-232 Serial Port Connector Pinouts (COM1)

4.3.9 RS-232 Serial Port Connector (COM2)

PIN NO.	DESCRIPTION	PIN NO.	DESCRIPTION
1	INDCD2	2	INRX2
3	INTX2	4	INDTR2

5	GND	6	INDSR2
7	INRTS2	8	INCTS2
9	INRI12		

Table 4-22: RS-232 Serial Port Connector Pinouts (COM2)

4.3.10 RS-232 Serial Port Connector (COM3)

PIN NO.	DESCRIPTION	PIN NO.	DESCRIPTION
1	INDCD3	2	INRX3
3	INTX3	4	INDTR3
5	GND	6	INDSR3
7	INRTS3	8	INCTS3
9	INRI3		

Table 4-23: RS-232 Serial Port Connector Pinouts (COM3)

4.3.11 RS-232 Serial Port Connector (COM4)

PIN NO.	DESCRIPTION	PIN NO.	DESCRIPTION
1	INDCD4	2	INRX4
3	INTX4	4	INDTR4
5	GND	6	INDSR4
7	INRTS4	8	INCTS4
9	INRI4		

Table 4-24: RS-232 Serial Port Connector Pinouts (COM4)

4.3.12 RS-232 Serial Port Connector (COM7)

PIN NO.	DESCRIPTION	PIN NO.	DESCRIPTION
1	-NDCD7	2	NSIN7
3	NSOUT7	4	-NDTR7
5	GND	6	-NDSR7
7	-NRTS7	8	-NCTS7
9	-XRI7		

Table 4-25: RS-232 Serial Port Connector Pinouts (COM7)

4.3.13 RS-232 Serial Port Connector (COM8)

PIN NO.	DESCRIPTION	PIN NO.	DESCRIPTION
1	-NDCD8	2	NSIN8
3	NSOUT8	4	-NDTR8
5	GND	6	-NDSR8
7	-NRTS8	8	-NCTS8
9	-XR18		

Table 4-26: RS-232 Serial Port Connector Pinouts (COM8)

4.3.14 RS-422/485 Serial Port Connectors (COM5)

PIN NO.	DESCRIPTION	PIN NO.	DESCRIPTION
A1	N/A	A2	ITXD5485#
A3	N/A	A4	ITXD5485+
A5	N/A	A6	IRXD5485#
A7	N/A	A8	IRXD5485+

Table 4-27: RS-422/485 Serial Port Connectors Pinouts (COM5)

4.3.15 RS-422/485 Serial Port Connectors (COM6)

PIN NO.	DESCRIPTION	PIN NO.	DESCRIPTION
B1	N/A	B2	ITXD6485#
B3	N/A	B4	ITXD6485+
B5	N/A	B6	IRXD6485#
B7	N/A	B8	IRXD6485+

Table 4-28: RS-422/485 Serial Port Connectors Pinouts (COM6)

4.3.16 USB 3.0 Connectors (USB3_12)

PIN NO.	DESCRIPTION	PIN NO.	DESCRIPTION
1	USB3_PWR1	2	USB2P0_DM1_L
3	USB2P0_DP1_L	4	GND
5	USB3P0_RXDN1	6	USB3P0_RXDP1
7	GND	8	USB3P0_TXDN1

9	USB3P0_TXDP1	10	USB3_PWR1
11	USB2P0_DM2_L	12	USB2P0_DP2_L
13	GND	14	USB3P0_RXDN2
15	USB3P0_RXDP2	16	GND
17	USB3P0_TXDN2	18	USB3P0_TXDP2

Table 4-29: USB 3.0 Connectors Pinouts (USB3_12)

4.3.17 VGA Connector (VGA1)

PIN NO.	DESCRIPTION	PIN NO.	DESCRIPTION
1	CRT_RED	2	CRT_GREEN
3	CRT_BLUE	4	NC
5	GND	6	GND
7	GND	8	GND
9	CRT_VCC	10	CRT_PLUG#
11	NC	12	CRT_DDC_DATA
13	CRT_HSYNC	14	CRT_VSYNC
15	CRT_DDC_CLK		

Table 4-30: VGA Connector Pinouts (VGA1)

4.4 Jumper Settings

The jumpers on the system motherboard are listed in **Table 4-31**.

Connector	Type	Label
Clear CMOS setup	3-pin header	J_CMOS2

Table 4-31: Jumper

4.4.1 Clear CMOS Setup (J_CMOS2)

Pin	Description
Short 1-2	Keep CMOS Setup (Default)
Short 2-3	Clear CMOS Setup

Table 4-32: Clear CMOS Setup Jumper Settings (J_CMOS2)

Chapter

5

BIOS

5.1 Introduction

The BIOS is programmed onto the BIOS chip. The BIOS setup program allows changes to certain system settings. This chapter outlines the options that can be changed.



NOTE:

Some of the BIOS options may vary throughout the life cycle of the product and are subject to change without prior notice.

5.1.1 Starting Setup

The UEFI BIOS is activated when the computer is turned on. The setup program can be activated in one of two ways.

1. Press the **DEL** or **F2** key as soon as the system is turned on or
2. Press the **DEL** or **F2** key when the “**Press DEL or F2 to enter SETUP**” message appears on the screen.

If the message disappears before the **DEL** or **F2** key is pressed, restart the computer and try again.

5.1.2 Using Setup

Use the arrow keys to highlight items, press **ENTER** to select, use the PageUp and PageDown keys to change entries, press **F1** for help and press **ESC** to quit. Navigation keys are shown in.

Key	Function
Up arrow	Move to previous item
Down arrow	Move to next item
Left arrow	Move to the item on the left hand side
Right arrow	Move to the item on the right hand side
+	Increase the numeric value or make changes

Key	Function
-	Decrease the numeric value or make changes
Page Up key	Increase the numeric value or make changes
Page Dn key	Decrease the numeric value or make changes
Esc key	Main Menu – Quit and not save changes into CMOS Status Page Setup Menu and Option Page Setup Menu -- Exit current page and return to Main Menu
F1	General help, only for Status Page Setup Menu and Option Page Setup Menu
F2	Previous values
F3	Load optimized defaults
F4	Save changes and Exit BIOS

Table 5-1: BIOS Navigation Keys

5.1.3 Getting Help

When **F1** is pressed a small help window describing the appropriate keys to use and the possible selections for the highlighted item appears. To exit the Help Window press **Esc** or the **F1** key again.

5.1.4 Unable to Reboot after Configuration Changes

If the computer cannot boot after changes to the system configuration is made, CMOS defaults. Use the jumper described in Chapter 2.

5.1.5 BIOS Menu Bar

The **menu bar** on top of the BIOS screen has the following main items:

- Main – Changes the basic system configuration.
- Advanced – Changes the advanced system settings.
- Chipset – Changes the chipset settings.
- Boot – Changes the system boot configuration.
- Security – Sets User and Supervisor Passwords.

- Save & Exit – Selects exit options and loads default settings.

The following sections completely describe the configuration options found in the menu items at the top of the BIOS screen and listed above.

TANK-820-H61 Embedded System

5.2 Main

The **Main** BIOS menu (**BIOS Menu 1**) appears when the **BIOS Setup** program is entered.

The **Main** menu gives an overview of the basic system information.

Aptio Setup Utility - Copyright (C) 2011 American Megatrends, Inc.					
Main	Advanced	Chipset	Boot	Security	Save & Exit
BIOS Information					
BIOS Vendor	American Megatrends			Set the Date. Use Tab to switch between Data elements.	
Core Version	4.6.5.3-0.19				
Compliancy	UEFI 2.3; PI 1.2				
Project Version	SE21AR33.ROM				
Build Date	08/28/2013 16:11:35				
Processor Information					
Name	IvyBridge				
Brand String	Genuine Intel(R) CPU				
Frequency	2400 MHz				
Processor ID	306a5				
Stepping	K0/M0				
Number of Processors	2Core(s) / 4Thread(s)				
Microcode Revision	7				
GT Info	GT2 (900 MHz)				
IGFX VBIOS Version 2137					
Memory RC Version 1.2.0.0					
Total Memory 2048 MB (DDR3 1333)					
Memory Frequency 1333 MHz					
PCH Information					
Name	CougarPoint				
Stepping	05/B3				
TXT Capability of Platform/PCH	Unsupported				
LAN PHY Revision	N/A			-----	
ME FW Version 8.0.3.1427					
ME Firmware SKU 1.5MB					
SPI Clock Frequency					
DOFR Support Supported					
Read Status Clock Frequency 33 MHz					
Write Status Clock Frequency 33 MHz					
Fast Read Status Clock Frequency 33 MHz					
iWDD Vendor iEi					
iWDD Version SE21ER10.bin					
System Date [Thu 12/26/2013]					
System Time [15:43:27]					
Access Level Administrator					
Version 2.14.1219. Copyright (C) 2011 American Megatrends, Inc.					

BIOS Menu 1: Main

The Main menu lists the following system details:

- BIOS Information
- Processor Information
- Memory Information
- PCH Information
- SPI Clock Frequency

The Main menu has two user configurable fields:

→ System Date [xx/xx/xx]

Use the **System Date** option to set the system date. Manually enter the day, month and year.

→ System Time [xx:xx:xx]

Use the **System Time** option to set the system time. Manually enter the hours, minutes and seconds.

5.3 Advanced

Use the **Advanced** menu (**BIOS Menu 2**) to configure the CPU and peripheral devices through the following sub-menus:



WARNING!

Setting the wrong values in the sections below may cause the system to malfunction. Make sure that the settings made are compatible with the hardware.

TANK-820-H61 Embedded System

```

Aptio Setup Utility - Copyright (C) 2011 American Megatrends, Inc.
Main  Advanced  Chipset  Boot  Security  Save & Exit

> ACPI Settings
> RTC Wake Settings
> Trusted Computing
> CPU Configuration
> SATA Configuration
> Intel TXT(LT) Configuration
> USB Configuration
> F81216 Secondary Super IO Configuration
> F81866 Super IO Configuration
> F81866 H/M Monitor
> Serial Port Console Redirection
> iEi Feature

System ACPI Parameters
-----
<=>: Select Screen
↑↓: Select Item
EnterSelect
+/-: Change Opt.
F1: General Help
F2: Previous Values
F3: Optimized Defaults
F4: Save & Exit
ESC: Exit

Version 2.14.1219. Copyright (C) 2011 American Megatrends, Inc.
  
```

BIOS Menu 2: Advanced

5.3.1 ACPI Settings

The **ACPI Settings** menu (**BIOS Menu 3**) configures the Advanced Configuration and Power Interface (ACPI) options.

```

Aptio Setup Utility - Copyright (C) 2011 American Megatrends, Inc.
Advanced

ACPI Settings
ACPI Sleep State          [S1 (CPU Stop Clock)]

Select ACPI sleep state
the system will enter
when the SUSPEND button
is pressed.
-----
<=>: Select Screen
↑↓: Select Item
EnterSelect
+/-: Change Opt.
F1: General Help
F2: Previous Values
F3: Optimized Defaults
F4: Save & Exit
ESC: Exit

Version 2.14.1219. Copyright (C) 2011 American Megatrends, Inc.
  
```

BIOS Menu 3: ACPI Configuration

➔ ACPI Sleep State [S1 (CPU Stop Clock)]

Use the **ACPI Sleep State** option to specify the sleep state the system enters when it is not being used.

➔ **S1 (CPU Stop Clock)** **DEFAULT** The system enters S1(POS) sleep state. The system appears off. The CPU is stopped; RAM is refreshed; the system is running in a low power mode.

➔ **S3 (Suspend to RAM)** The caches are flushed and the CPU is powered off. Power to the RAM is maintained. The computer returns slower to a working state, but more power is saved.

5.3.2 RTC Wake Settings

The **RTC Wake Settings** menu (**BIOS Menu 4**) configures RTC wake event.

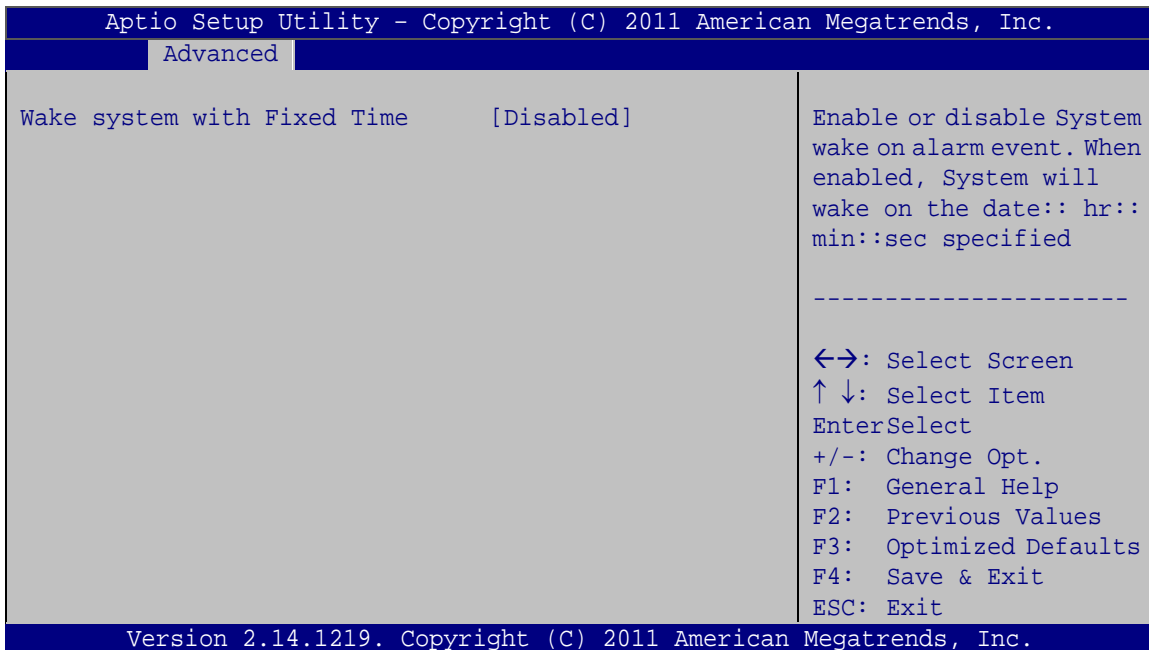

BIOS Menu 4: RTC Wake Settings

TANK-820-H61 Embedded System

→ Wake System with Fixed Time [Disabled]

Use the **Wake System with Fixed Time** option to specify the time the system should be roused from a suspended state.

→ **Disabled** **DEFAULT** The real time clock (RTC) cannot generate a wake event

→ **Enabled** If selected, the following appears with values that can be selected:

*Wake up every day

*Wake up date

*Wake up hour

*Wake up minute

*Wake up second

After setting the alarm, the computer turns itself on from a suspend state when the alarm goes off.

5.3.3 Trusted Computing

Use the **Trusted Computing** menu (**BIOS Menu 5**) to configure settings related to the Trusted Computing Group (TCG) Trusted Platform Module (TPM).

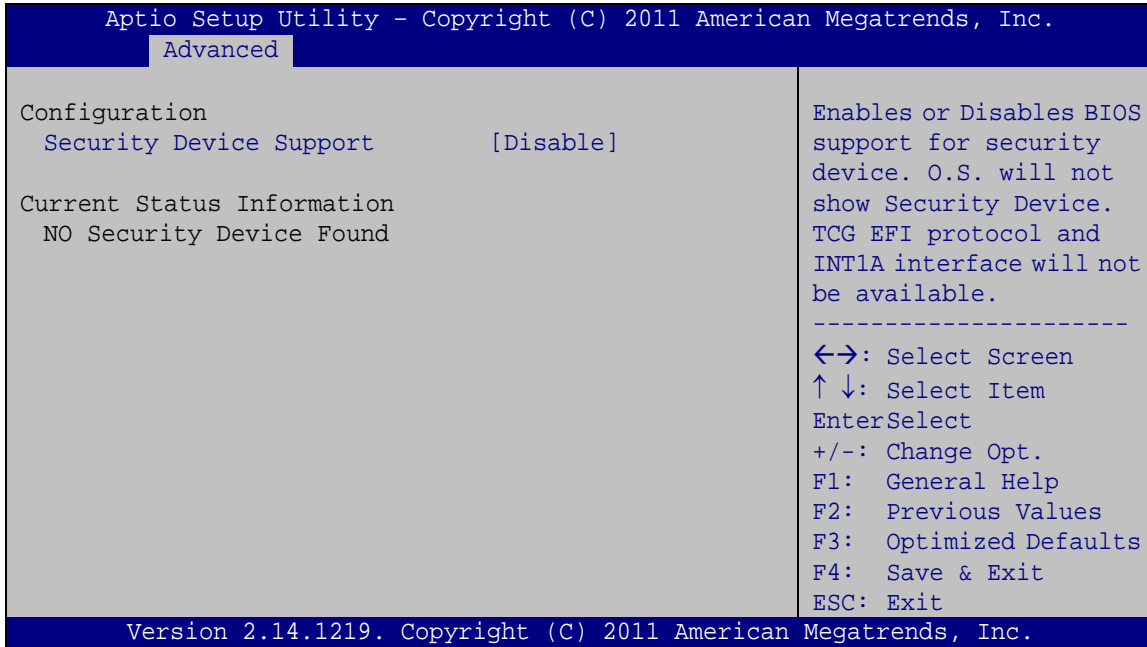

BIOS Menu 5: TPM Configuration

➔ Security Device Support [Disable]

Use the **Security Device Support** option to configure support for the security device.

➔ **Disable** **DEFAULT** Security device support is disabled.

➔ **Enable** Security device support is enabled.

5.3.4 CPU Configuration

Use the **CPU Configuration** menu (**BIOS Menu 6**) to enter the **CPU Information** submenu or enable Intel Virtualization Technology.

TANK-820-H61 Embedded System

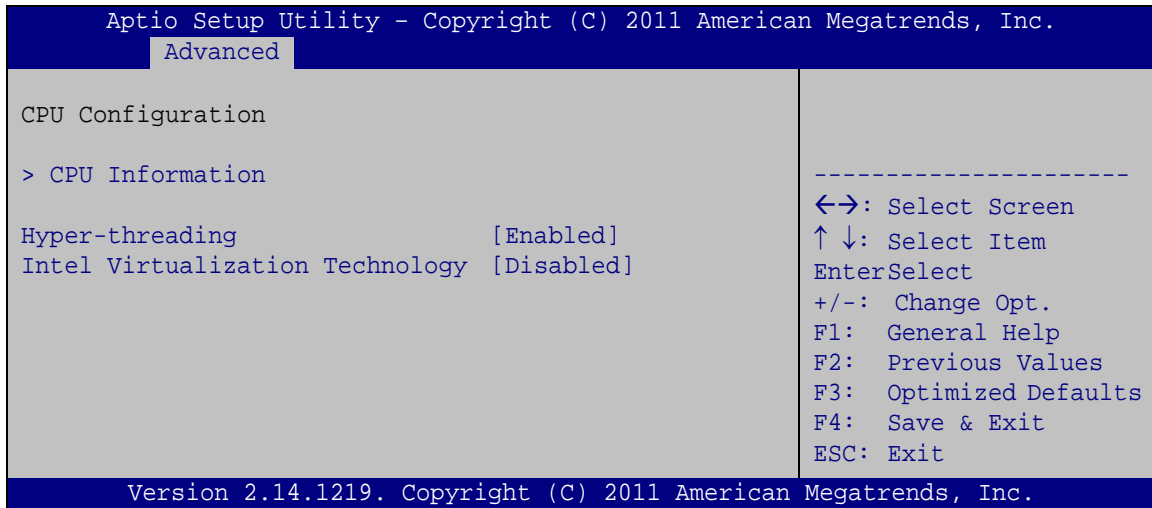
**BIOS Menu 6: CPU Configuration**

→ Hyper-threading [Enabled]

Use the **Hyper-threading** BIOS option to enable or disable the Intel Hyper-Threading Technology.

→ **Disabled** Disables the Intel Hyper-Threading Technology.

→ **Enabled** **DEFAULT** Enables the Intel Hyper-Threading Technology.

→ Intel Virtualization Technology [Disabled]

Use the **Intel Virtualization Technology** option to enable or disable virtualization on the system. When combined with third party software, Intel Virtualization technology allows several OSs to run on the same system at the same time.

→ **Disabled** **DEFAULT** Disables Intel Virtualization Technology.

→ **Enabled** Enables Intel Virtualization Technology.

5.3.4.1 CPU Information

Use the **CPU Information** submenu (**BIOS Menu 7**) to view detailed CPU specifications and configure the CPU.

Aptio Setup Utility - Copyright (C) 2011 American Megatrends, Inc.

Advanced

CPU Information		
Genuine Intel(R) CPU @ 2.40GHz		
CPU Signature	306a5	-----
Microcode Patch	7	
Max CPU Speed	2400 MHz	
Min CPU Speed	1600 MHz	
CPU Speed	2400 MHz	
Processor Cores	2	
Intel HT Technology	Supported	
Intel VT-x Technology	Supported	
Intel SMX Technology	Not Supported	
64-bit	Supported	
L1 Data Cache	32 kB x 2	
L1 Code Cache	32 kB x 2	
L2 Cache	256 kB x 2	
L3 Cache	3072 kB	

←→: Select Screen
 ↑ ↓: Select Item
 Enter>Select
 +/-: Change Opt.
 F1: General Help
 F2: Previous Values
 F3: Optimized Defaults
 F4: Save & Exit
 ESC: Exit

Version 2.14.1219. Copyright (C) 2011 American Megatrends, Inc.

BIOS Menu 7: CPU Configuration

The CPU Configuration menu (**BIOS Menu 7**) lists the following CPU details:

- Processor Type: Lists the brand name of the CPU being used
- CPU Signature: Lists the CPU signature value.
- Microcode Patch: Lists the microcode patch being used.
- Max CPU Speed: Lists the maximum CPU processing speed.
- Min CPU Speed: Lists the minimum CPU processing speed.
- CPU Speed: Lists the CPU processing speed.
- Processor Cores: Lists the number of the processor core
- Intel HT Technology: Indicates if Intel HT Technology is supported by the CPU.
- Intel VT-x Technology: Indicates if Intel VT-x Technology is supported by the CPU.
- Intel SMX Technology: Indicates if Intel SMX Technology is supported by the CPU.
- 64-bit: Indicates if 64-bit is supported by the CPU.
- L1 Data Cache: Lists the amount of data storage space on the L1 cache.
- L1 Code Cache: Lists the amount of code storage space on the L1 cache.

TANK-820-H61 Embedded System

- L2 Cache: Lists the amount of storage space on the L2 cache.
- L3 Cache: Lists the amount of storage space on the L3 cache.

5.3.5 SATA Configuration

Use the **SATA Configuration** menu (**BIOS Menu 8**) to change and/or set the configuration of the SATA devices installed in the system.

```

Aptio Setup Utility - Copyright (C) 2011 American Megatrends, Inc.
  Advanced
SATA Controller(s)          [Enabled]          Enable or disable SATA
SATA Mode Selection        [IDE]              Device.
Serial ATA Port 1          Empty
-----
<->: Select Screen
↑ ↓: Select Item
EnterSelect
+/-: Change Opt.
F1:  General Help
F2:  Previous Values
F3:  Optimized Defaults
F4:  Save & Exit
ESC: Exit
Version 2.14.1219. Copyright (C) 2011 American Megatrends, Inc.
  
```

BIOS Menu 8: IDE Configuration

➔ SATA Controller(s) [Enabled]

Use the **SATA Controller(s)** option to configure the serial ATA controller.

- ➔ **Enabled** **DEFAULT** Enables the on-board SATA controller.
- ➔ **Disabled** Disables the on-board SATA controller.

5.3.6 Intel TXT(LT) Configuration

Use the **Intel TXT(LT) Configuration** menu (**BIOS Menu 9**) to configure Intel Trusted Execution Technology support.

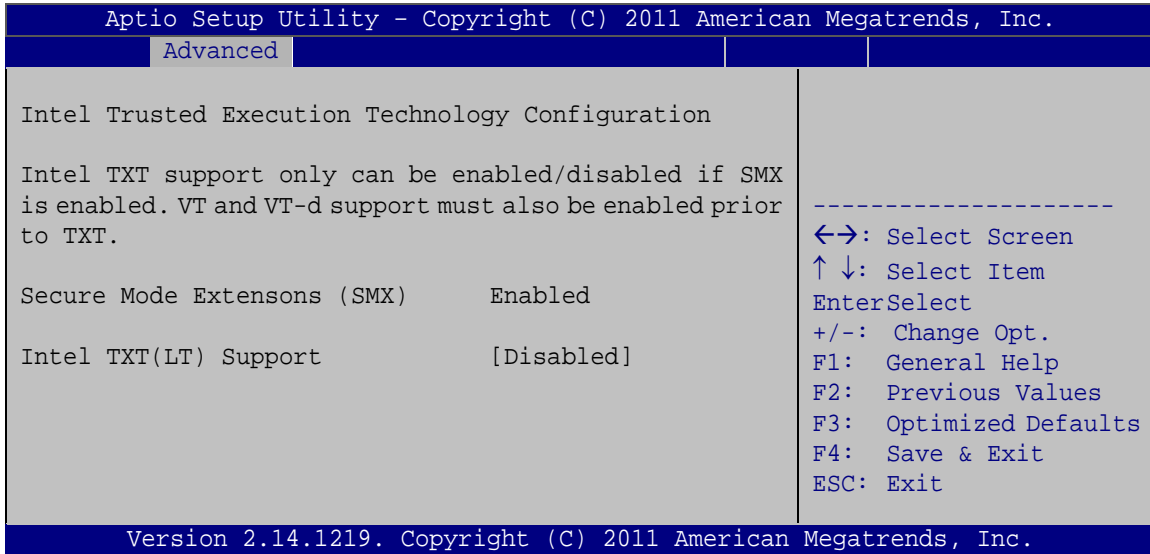

BIOS Menu 9: Intel TXT(LT) Configuration

5.3.7 USB Configuration

Use the **USB Configuration** menu (**BIOS Menu 10**) to read USB configuration information and configure the USB settings.

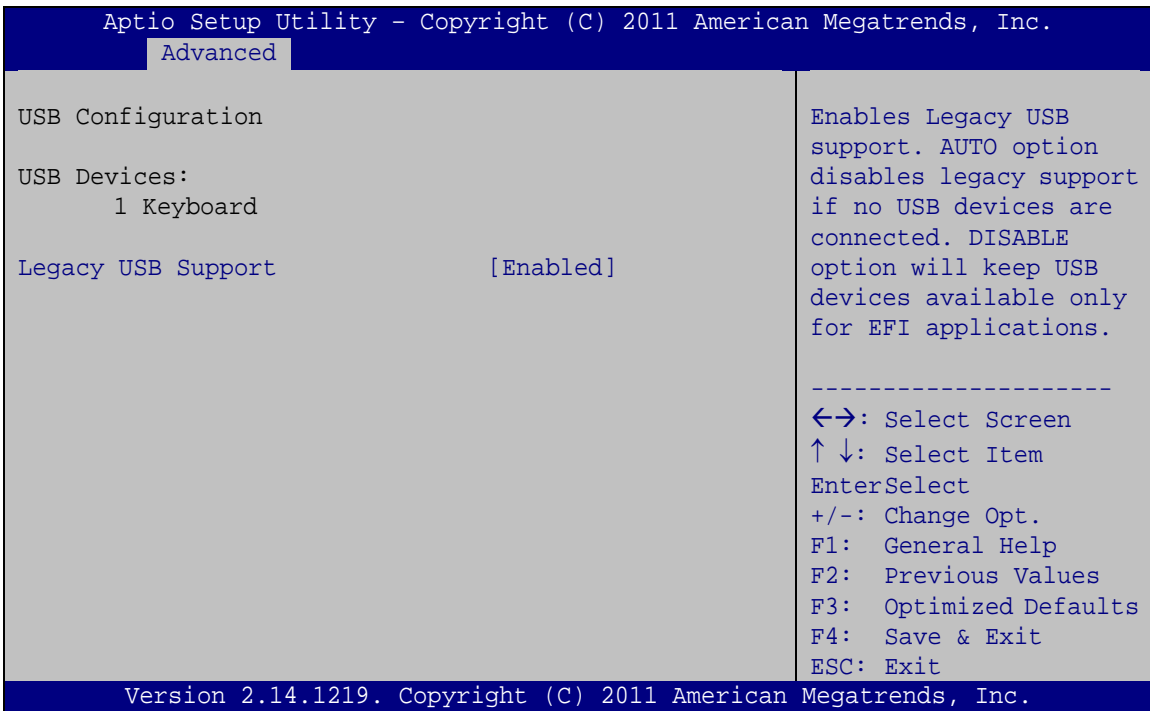

BIOS Menu 10: USB Configuration

TANK-820-H61 Embedded System

➔ USB Devices

The **USB Devices** field lists the USB devices that are enabled on the system

➔ Legacy USB Support [Enabled]

Use the **Legacy USB Support** BIOS option to enable USB mouse and USB keyboard support. Normally if this option is not enabled, any attached USB mouse or USB keyboard does not become available until a USB compatible operating system is fully booted with all USB drivers loaded. When this option is enabled, any attached USB mouse or USB keyboard can control the system even when there is no USB driver loaded onto the system.

- ➔ **Enabled** **DEFAULT** Legacy USB support enabled
- ➔ **Disabled** Legacy USB support disabled
- ➔ **Auto** Legacy USB support disabled if no USB devices are connected

5.3.8 F81216 Secondary Super IO Configuration

Use the **F81216 Secondary Super IO Configuration** menu (**BIOS Menu 11**) to set or change the configurations for the serial ports.

```

Aptio Setup Utility - Copyright (C) 2011 American Megatrends, Inc.
  Advanced
F81216 Secondary Super IO Configuration
Second Super IO Chip          F81216 SecondIO
> Serial Port 7 Configuration
> Serial Port 8 Configuration
Set Parameters of Serial
Port 7 (COMA)
-----
<->: Select Screen
↑ ↓: Select Item
Enter>Select
+/-: Change Opt.
F1:  General Help
F2:  Previous Values
F3:  Optimized Defaults
F4:  Save & Exit
ESC: Exit
Version 2.14.1219. Copyright (C) 2011 American Megatrends, Inc.
  
```

BIOS Menu 11: Secondary Super IO Configuration

5.3.8.1 Serial Port n Configuration

Use the **Serial Port n Configuration** menu (**BIOS Menu 12**) to configure the serial port n.

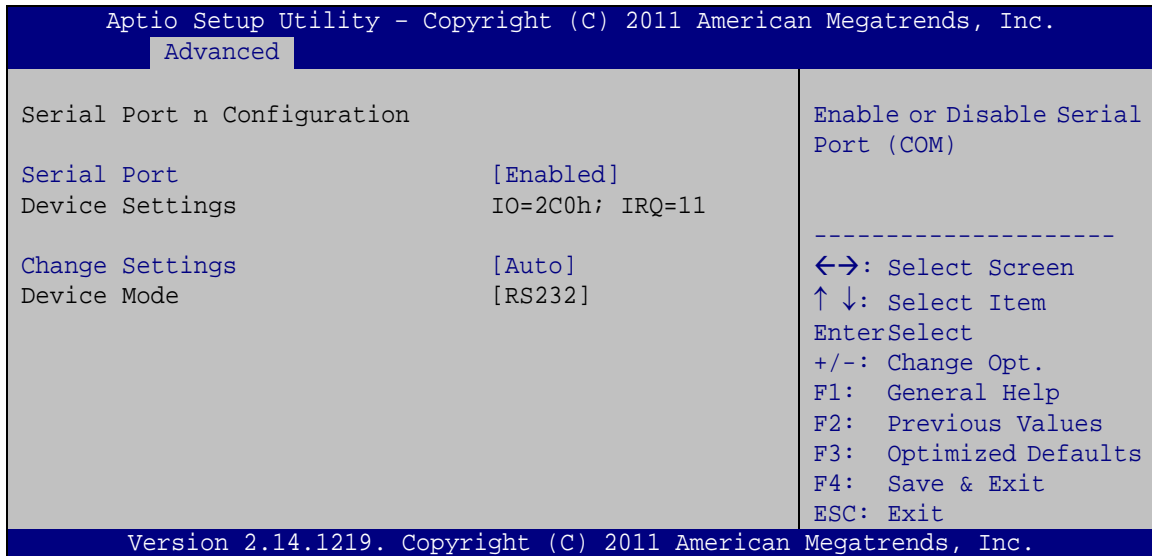

BIOS Menu 12: Serial Port n Configuration Menu

5.3.8.1.1 Serial Port 7 Configuration

→ Serial Port [Enabled]

Use the **Serial Port** option to enable or disable the serial port.

- **Disabled** Disable the serial port
- **Enabled** **DEFAULT** Enable the serial port

→ Change Settings [Auto]

Use the **Change Settings** option to change the serial port IO port address and interrupt address.

- **Auto** **DEFAULT** The serial port IO port address and interrupt address are automatically detected.
- **IO=2C0h;**
IRQ=11 Serial Port I/O port address is 2C0h and the interrupt address is IRQ11

TANK-820-H61 Embedded System

- ➔ **IO=2C0h;** Serial Port I/O port address is 2C0h and the interrupt
IRQ=10, 11 address is IRQ10, 11
- ➔ **IO=2C8h;** Serial Port I/O port address is 2C8h and the interrupt
IRQ=10, 11 address is IRQ10, 11

➔ Device Mode [RS232]

The **Device Mode** shows Serial Port 7 provides RS-232 communications.

5.3.8.1.2 Serial Port 8 Configuration

➔ Serial Port [Enabled]

Use the **Serial Port** option to enable or disable the serial port.

- ➔ **Disabled** Disable the serial port
- ➔ **Enabled DEFAULT** Enable the serial port

➔ Change Settings [Auto]

Use the **Change Settings** option to change the serial port IO port address and interrupt address.

- ➔ **Auto DEFAULT** The serial port IO port address and interrupt address
are automatically detected.
- ➔ **IO=2C8h;** Serial Port I/O port address is 2C8h and the interrupt
IRQ=11 address is IRQ11
- ➔ **IO=2C0h;** Serial Port I/O port address is 2C0h and the interrupt
IRQ=10, 11 address is IRQ10, 11
- ➔ **IO=2C8h;** Serial Port I/O port address is 2C8h and the interrupt
IRQ=10, 11 address is IRQ10, 11

➔ Device Mode [RS232]

The **Device Mode** shows Serial Port 8 provides RS-232 communications.

5.3.9 F81866 Super IO Configuration

Use the **F81866 Super IO Configuration** menu (**BIOS Menu 13**) to set or change the configurations for the serial ports.

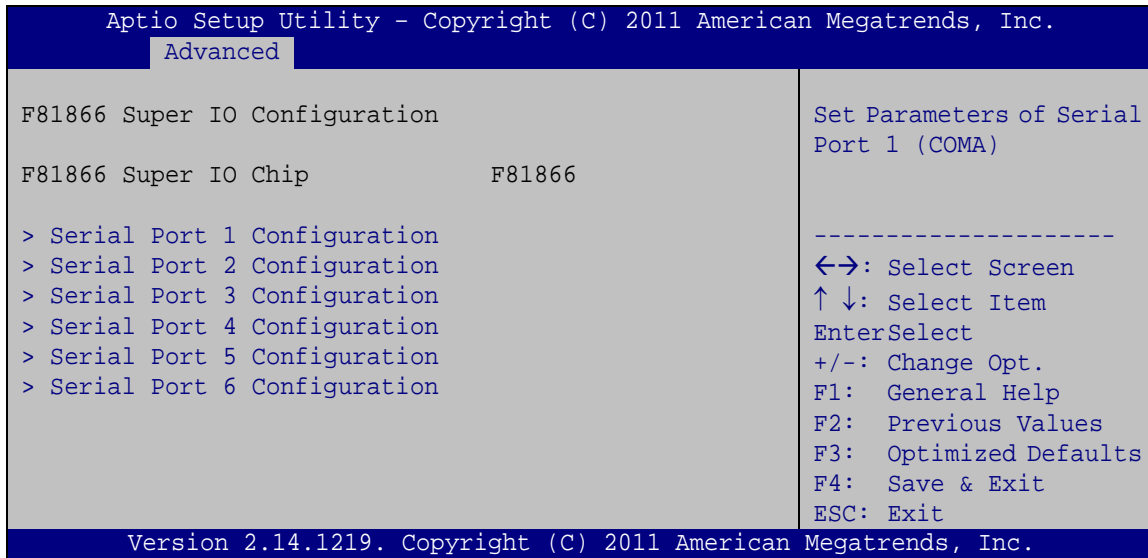

BIOS Menu 13: F81866 Super IO Configuration

5.3.9.1 Serial Port n Configuration

Use the **Serial Port n Configuration** menu (**BIOS Menu 14**) to configure the serial port n.

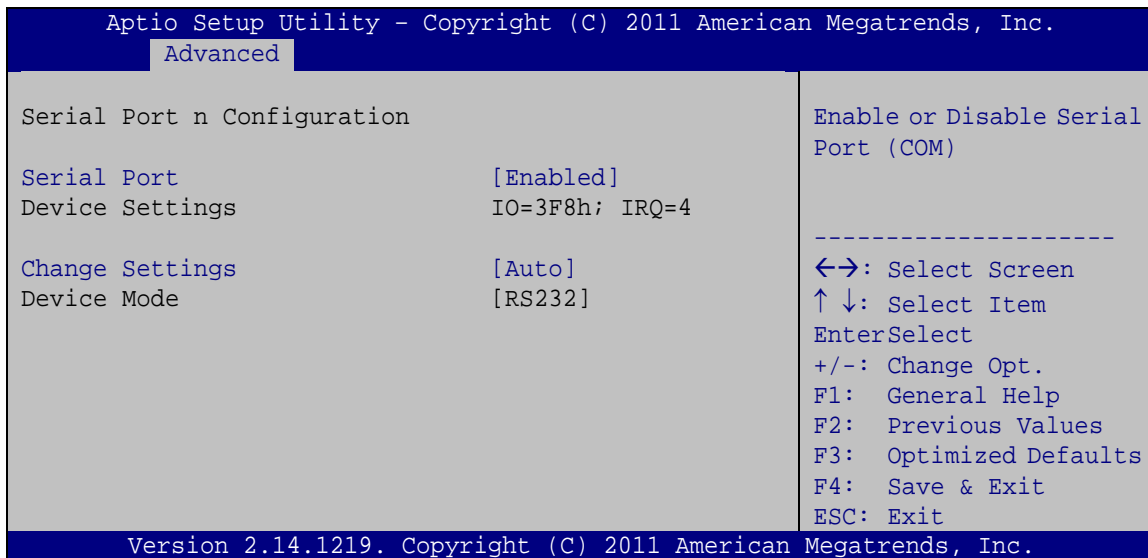

BIOS Menu 14: Serial Port n Configuration Menu

TANK-820-H61 Embedded System

5.3.9.1.1 Serial Port 1 Configuration

→ Serial Port [Enabled]

Use the **Serial Port** option to enable or disable the serial port.

- **Disabled** Disable the serial port
- **Enabled** **DEFAULT** Enable the serial port

→ Change Settings [Auto]

Use the **Change Settings** option to change the serial port IO port address and interrupt address.

- **Auto** **DEFAULT** The serial port IO port address and interrupt address are automatically detected.
- **IO=3F8h;**
IRQ=4 Serial Port I/O port address is 3F8h and the interrupt address is IRQ4
- **IO=3F8h;**
IRQ=3, 4 Serial Port I/O port address is 3F8h and the interrupt address is IRQ3, 4
- **IO=2F8h;**
IRQ=3, 4 Serial Port I/O port address is 2F8h and the interrupt address is IRQ3, 4

→ Device Mode [RS232]

The **Device Mode** shows Serial Port 1 provides RS-232 communications.

5.3.9.1.2 Serial Port 2 Configuration

→ Serial Port [Enabled]

Use the **Serial Port** option to enable or disable the serial port.

- **Disabled** Disable the serial port
- **Enabled** **DEFAULT** Enable the serial port

→ Change Settings [Auto]

Use the **Change Settings** option to change the serial port IO port address and interrupt address.

- **Auto** **DEFAULT** The serial port IO port address and interrupt address are automatically detected.
- **IO=2F8h;**
IRQ=3 Serial Port I/O port address is 2F8h and the interrupt address is IRQ3
- **IO=3F8h;**
IRQ=3, 4 Serial Port I/O port address is 3F8h and the interrupt address is IRQ3, 4
- **IO=2F8h;**
IRQ=3, 4 Serial Port I/O port address is 2F8h and the interrupt address is IRQ3, 4

→ Device Mode [RS232]

The **Device Mode** shows Serial Port 2 provides RS-232 communications.

5.3.9.1.3 Serial Port 3 Configuration

→ Serial Port [Enabled]

Use the **Serial Port** option to enable or disable the serial port.

- **Disabled** Disable the serial port
- **Enabled** **DEFAULT** Enable the serial port

→ Change Settings [Auto]

Use the **Change Settings** option to change the serial port IO port address and interrupt address.

- **Auto** **DEFAULT** The serial port IO port address and interrupt address are automatically detected.

TANK-820-H61 Embedded System

- ➔ **IO=3E8h;**
IRQ=10 Serial Port I/O port address is 3E8h and the interrupt address is IRQ10
- ➔ **IO=3E8h;**
IRQ=10, 11 Serial Port I/O port address is 3E8h and the interrupt address is IRQ10, 11
- ➔ **IO=2E8h;**
IRQ=10, 11 Serial Port I/O port address is 2E8h and the interrupt address is IRQ10, 11

➔ Device Mode [RS232]

The **Device Mode** shows Serial Port 3 provides RS-232 communications.

5.3.9.1.4 Serial Port 4 Configuration

➔ Serial Port [Enabled]

Use the **Serial Port** option to enable or disable the serial port.

- ➔ **Disabled** Disable the serial port
- ➔ **Enabled DEFAULT** Enable the serial port

➔ Change Settings [Auto]

Use the **Change Settings** option to change the serial port IO port address and interrupt address.

- ➔ **Auto DEFAULT** The serial port IO port address and interrupt address are automatically detected.
- ➔ **IO=2E8h;**
IRQ=10 Serial Port I/O port address is 2E8h and the interrupt address is IRQ10
- ➔ **IO=3E8h;**
IRQ=10, 11 Serial Port I/O port address is 3E8h and the interrupt address is IRQ10, 11
- ➔ **IO=2E8h;**
IRQ=10, 11 Serial Port I/O port address is 2E8h and the interrupt address is IRQ10, 11

➔ Device Mode [RS232]

The **Device Mode** shows Serial Port 4 provides RS-232 communications.

5.3.9.1.5 Serial Port 5 Configuration

➔ Serial Port [Enabled]

Use the **Serial Port** option to enable or disable the serial port.

- ➔ **Disabled** Disable the serial port
- ➔ **Enabled DEFAULT** Enable the serial port

➔ Change Settings [Auto]

Use the **Change Settings** option to change the serial port IO port address and interrupt address.

- ➔ **Auto DEFAULT** The serial port IO port address and interrupt address are automatically detected.
- ➔ **IO=2D0h;
IRQ=10** Serial Port I/O port address is 2D0h and the interrupt address is IRQ10
- ➔ **IO=2D0h;
IRQ=10, 11** Serial Port I/O port address is 2D0h and the interrupt address is IRQ10, 11
- ➔ **IO=2D8h;
IRQ=10, 11** Serial Port I/O port address is 2D8h and the interrupt address is IRQ10, 11

➔ Device Mode [RS422/485]

The **Device Mode** shows Serial Port 5 provides RS-422/485 communications.

TANK-820-H61 Embedded System

5.3.9.1.6 Serial Port 6 Configuration

→ Serial Port [Enabled]

Use the **Serial Port** option to enable or disable the serial port.

- **Disabled** Disable the serial port
- **Enabled** **DEFAULT** Enable the serial port

→ Change Settings [Auto]

Use the **Change Settings** option to change the serial port IO port address and interrupt address.

- **Auto** **DEFAULT** The serial port IO port address and interrupt address are automatically detected.
- **IO=2D8h;**
IRQ=10 Serial Port I/O port address is 2D8h and the interrupt address is IRQ10
- **IO=2D0h;**
IRQ=10, 11 Serial Port I/O port address is 2D0h and the interrupt address is IRQ10, 11
- **IO=2D8h;**
IRQ=10, 11 Serial Port I/O port address is 2D8h and the interrupt address is IRQ10, 11

→ Device Mode [RS422/485]

The **Device Mode** shows Serial Port 6 provides RS-422/485 communications.

5.3.10 F81866 H/W Monitor

The **F8186 H/W Monitor** menu (**BIOS Menu 15**) shows the operating temperature, fan speeds and system voltages.

```

Aptio Setup Utility - Copyright (C) 2011 American Megatrends, Inc.
Advanced
PC Health Status
> Smart Fan Mode Configuration
CPU Temperature           :+62 C
System Temperature       :+37 C
Fan1 Speed                :2325 RPM
Fan2 Speed                :N/A
Smart Fan Mode Select
-----
<=>: Select Screen
↑↓: Select Item
Enter>Select
+/-: Change Opt.
F1:  General Help
F2:  Previous Values
F3:  Optimized
Defaults
F4:  Save & Exit
ESC: Exit
Version 2.14.1219. Copyright (C) 2011 American Megatrends, Inc.

```

BIOS Menu 15: Hardware Health Configuration

→ PC Health Status

The following system parameters and values are shown. The system parameters that are monitored are:

- System Temperatures:
 - CPU Temperature
 - System Temperature
- Fan Speeds:
 - Fan1 Speed
 - Fan2 Speed

5.3.10.1 Smart Fan Mode Configuration

Use the **Smart Fan Mode Configuration** submenu (**BIOS Menu 16**) to configure the smart fan temperature and speed settings.

TANK-820-H61 Embedded System

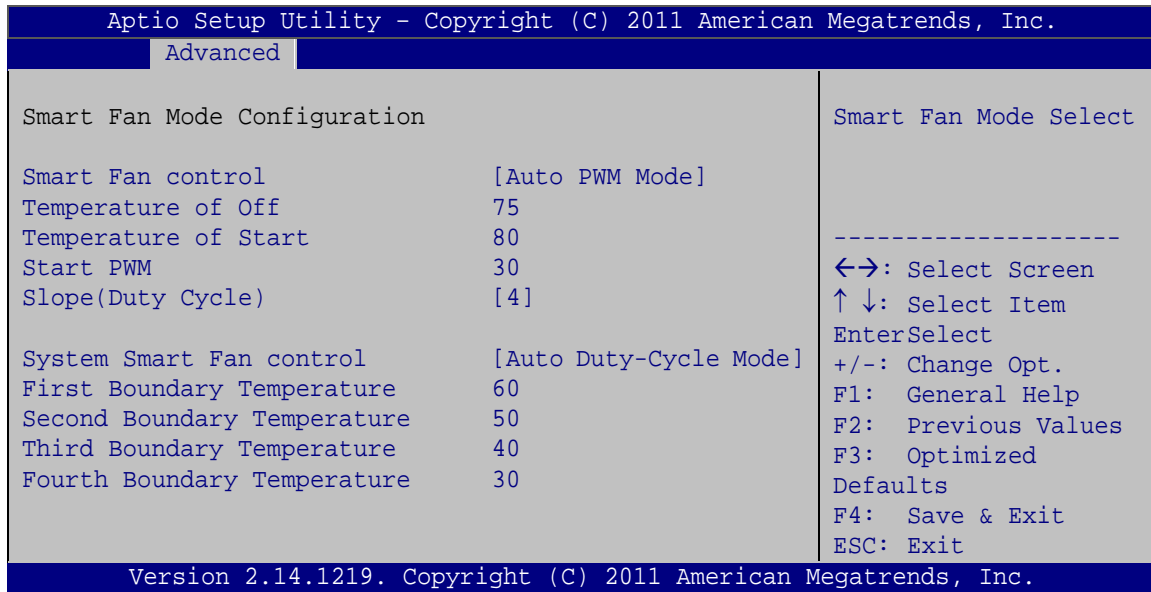

BIOS Menu 16: FAN Configuration

→ Smart Fan control [Auto PWM Mode]

Use the **Smart Fan control** BIOS option to configure the CPU Smart Fan.

- **Full Mode** Fan is on all the time
- **Manual PWM Mode** The fan spins at the speed set in the manual setting
- **Auto PWM Mode** **DEFAULT** The fan adjusts its speed using these settings:
 - Temperature of Start
 - Temperature of Off
 - Start PWM
 - Slope (Duty Cycle)

→ Temperature of Off [75]



WARNING:

Setting this value too high may cause the fan to speed up only when

the CPU is at a very high temperature and therefore cause the system to be damaged.

The **Temperature of Off** option can only be set if the **Smart Fan control** option is set to **Auto PWM Mode**. When the **CPU Temperature** is lower than **Temperature of Off**, the fan will be rotate at lowest speed. To set a value, select the **Temperature of Off** option and enter a decimal number between 0 and 127. The temperature range is specified below.

- Minimum Value: 0°C
- Maximum Value: 127°C

→ Temperature of Start [80]



WARNING:

Setting this value too high may cause the fan to rotate at full speed only when the CPU is at a very high temperature and therefore cause the system to be damaged.

The **Temperature of Start** option can only be set if the **Smart Fan control** option is set to **Auto PWM Mode**. Use the **Temperature of Start** option to set the CPU temperature at which the cooling fan starts to rotate using the starting pulse width modulation (PWM) specified in the **Start PWM** option below. To set a value, select the **Temperature of Start** option and enter a decimal number between 0 and 127. The temperature range is specified below.

- Minimum Value: 0°C
- Maximum Value: 127°C

→ Start PWM [30]

The **Start PWM** option can only be set if the **Smart Fan control** option is set to **Auto PWM Mode**. Use the **Start PWM** option to set the PWM start value. To set a value, select

TANK-820-H61 Embedded System

the **Start PWM** option and enter a decimal number between 0 and 100. The temperature range is specified below.

- Minimum Value: 0
- Maximum Value: 100

➔ Slope (Duty Cycle) [4 (PWM)]

The **Slope (Duty Cycle)** option can only be set if the **Smart Fan control** option is set to **Auto PWM Mode**. Use the **Slope (Duty Cycle)** option to select the linear rate at which the PWM mode increases with respect to an increase in temperature. A list of available options is shown below:

- 0
- 1
- 2
- 4
- 8
- 16

➔ System Smart Fan control [Auto Duty-Cycle Mode]

Use the **System Smart Fan control** BIOS option to configure the System Smart Fan.

- | | |
|-------------------------------|---|
| ➔ Manual Duty Mode | The fan spins at the speed set in the manual setting |
| ➔ Auto Duty-Cycle Mode | <p>The fan adjusts its speed using these settings:</p> <ul style="list-style-type: none"> First Boundary Temperature Second Boundary Temperature Third Boundary Temperature Fourth Boundary Temperature |

→ First Boundary Temperature

Use the + or – key to change the **First Boundary Temperature** value. Enter a decimal number between 1 and 100.

→ Second Boundary Temperature

Use the + or – key to change the **Second Boundary Temperature** value. Enter a decimal number between 1 and 100.

→ Third Boundary Temperature

Use the + or – key to change the **Third Boundary Temperature** value. Enter a decimal number between 1 and 100.

→ Fourth Boundary Temperature

Use the + or – key to change the **Fourth Boundary Temperature** value. Enter a decimal number between 1 and 100.

5.3.11 Serial Port Console Redirection

The **Serial Port Console Redirection** menu (**BIOS Menu 17**) allows the console redirection options to be configured. Console redirection allows users to maintain a system remotely by re-directing keyboard input and text output through the serial port.

TANK-820-H61 Embedded System

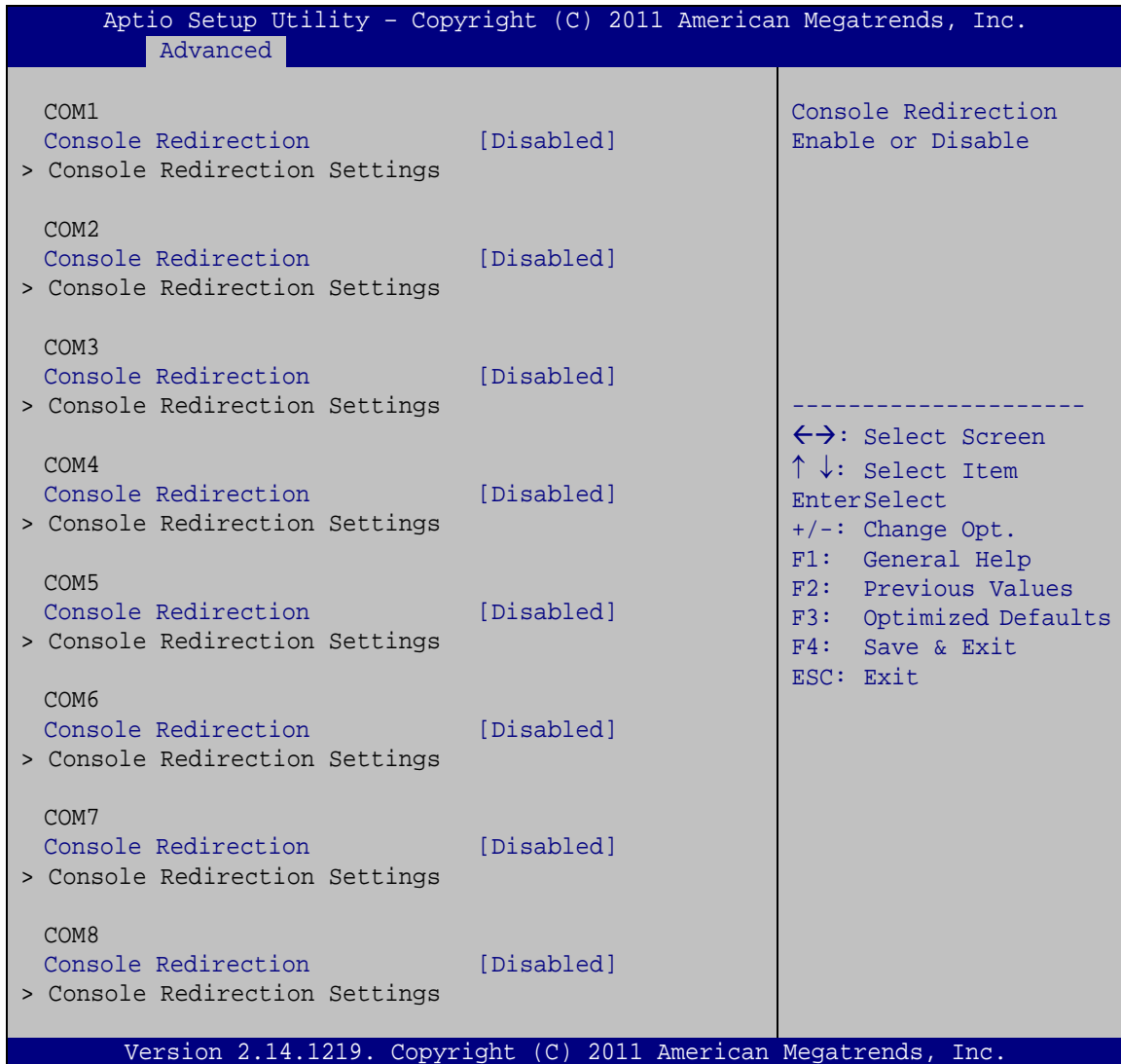

BIOS Menu 17: Serial Port Console Redirection

➔ Console Redirection [Disabled]

Use **Console Redirection** option to enable or disable the console redirection function.

➔ **Disabled** **DEFAULT** Disabled the console redirection function

➔ **Enabled** Enabled the console redirection function

5.3.11.1 Console Redirection Settings

The **Console Redirection Settings** menu (**BIOS Menu 18**) allows the console redirection options to be configured. The option is active when Console Redirection option is enabled.

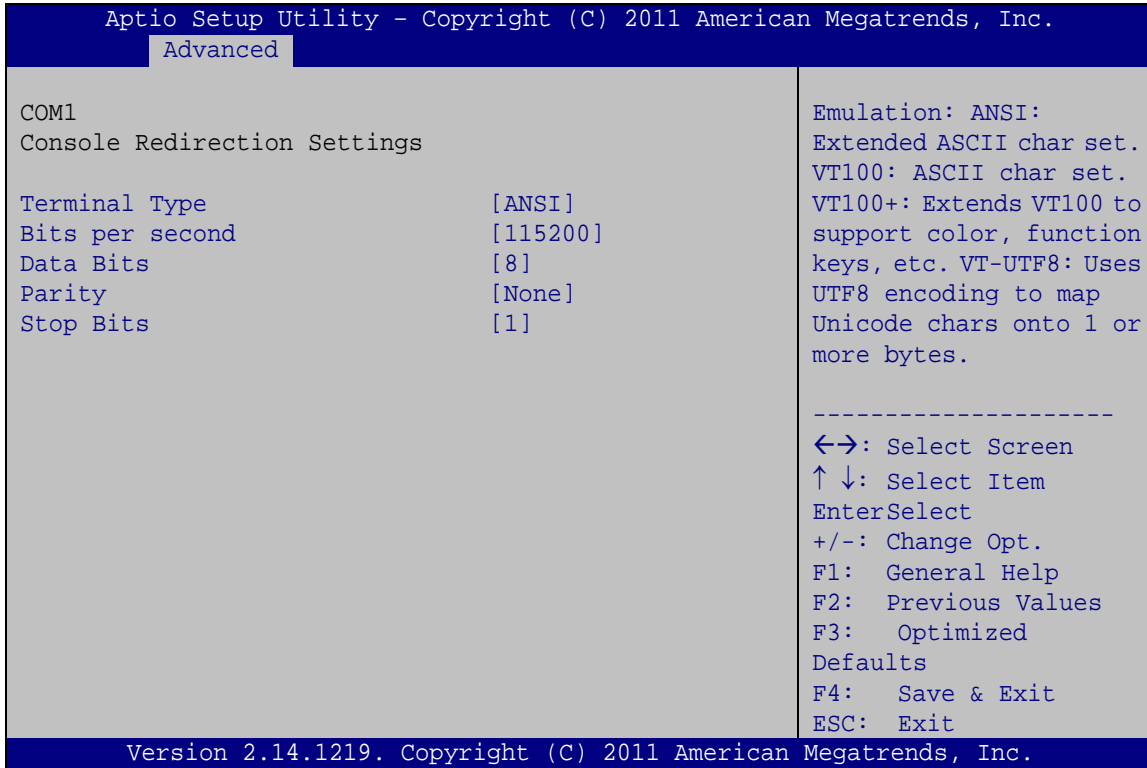

BIOS Menu 18: Console Redirection Settings

→ Terminal Type [ANSI]

Use the **Terminal Type** option to specify the remote terminal type..

- **VT100** The target terminal type is VT100
- **VT100+** The target terminal type is VT100+
- **VT-UTF8** The target terminal type is VT-UTF8
- **ANSI** **DEFAULT** The target terminal type is ANSI

→ Bits per second [115200]

Use the **Bits per second** option to specify the transmission speed of the serial port.

- **9600** The transmission speed is 9600
- **19200** The transmission speed is 19200
- **38400** The transmission speed is 38400

TANK-820-H61 Embedded System

- **57600** The transmission speed is 57600
- **115200** **DEFAULT** The transmission speed is 115200

→ Data Bits [8]

Use the **Data Bits** option to specify the number of data bits.

- **7** Sets the data bits at 7.
- **8** **DEFAULT** Sets the data bits at 8.

→ Parity [None]

Use the **Parity** option to specify the parity bit that can be sent with the data bits for detecting the transmission errors.

- **None** **DEFAULT** No parity bit is sent with the data bits.
- **Even** The parity bit is 0 if the number of ones in the data bits is even.
- **Odd** The parity bit is 0 if the number of ones in the data bits is odd.
- **Mark** The parity bit is always 1. This option does not provide error detection.
- **Space** The parity bit is always 0. This option does not provide error detection.

→ Stop Bits [1]

Use the **Stop Bits** option to specify the number of stop bits used to indicate the end of a serial data packet. Communication with slow devices may require more than 1 stop bit.

- **1** **DEFAULT** Sets the number of stop bits at 1.
- **2** Sets the number of stop bits at 2.

5.3.12 iEi Feature

Use the **iEi Feature** menu (**BIOS Menu 19**) to configure the iEi features.

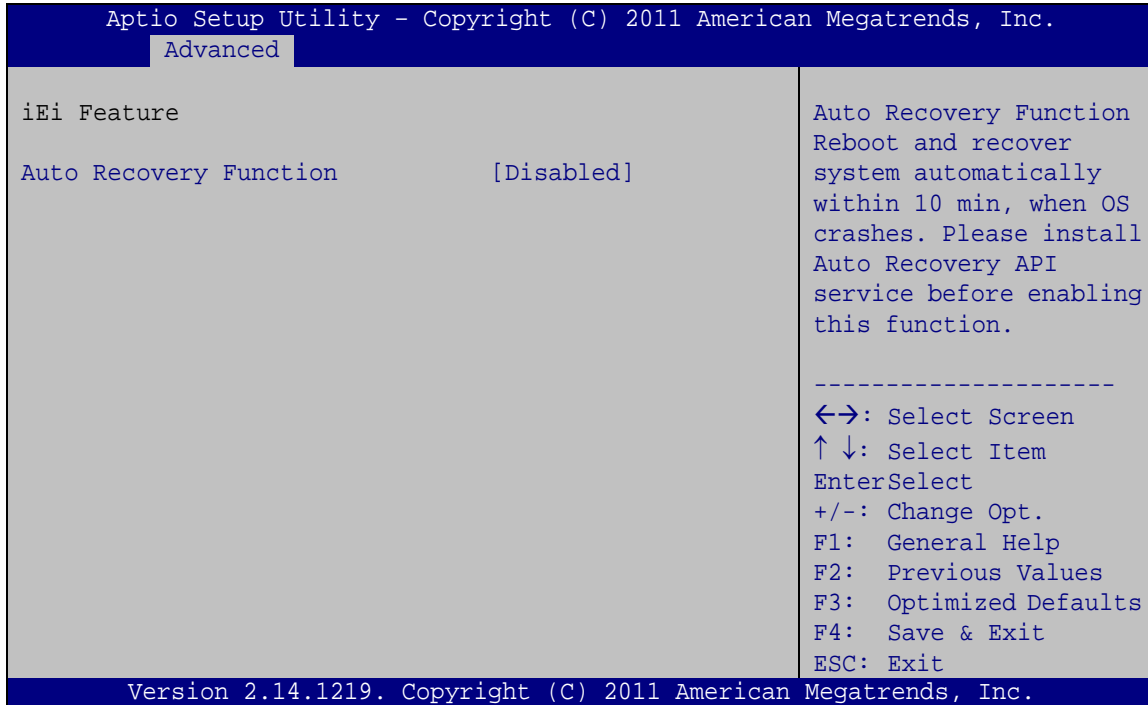

BIOS Menu 19: iEi Feature

➔ Auto Recovery Function [Disabled]

Use **Auto Recovery Function** option to enable or disable the auto recovery function.

- ➔ **Disabled** **DEFAULT** Disabled the auto recovery function
- ➔ **Enabled** Enabled the auto recovery function

TANK-820-H61 Embedded System

5.4 Chipset

Use the **Chipset** menu (**BIOS Menu 20**) to access the Northbridge and Southbridge configuration menus.

**WARNING!**

Setting the wrong values for the Chipset BIOS selections in the Chipset BIOS menu may cause the system to malfunction.

```
Aptio Setup Utility - Copyright (C) 2011 American Megatrends, Inc.
Main   Advanced  Chipset  Boot   Security  Save & Exit
-----
> PCH-IO Configuration          PCH Parameters
> System Agent (SA) Configuration

-----
<=>: Select Screen
↑ ↓: Select Item
EnterSelect
+/-: Change Opt.
F1:  General Help
F2:  Previous Values
F3:  Optimized Defaults
F4:  Save & Exit
ESC: Exit

Version 2.14.1219. Copyright (C) 2011 American Megatrends, Inc.
```

BIOS Menu 20: Chipset

5.4.1 PCH-IO Configuration

Use the **PCH-IO Configuration** menu (**BIOS Menu 21**) to configure the PCH parameters.

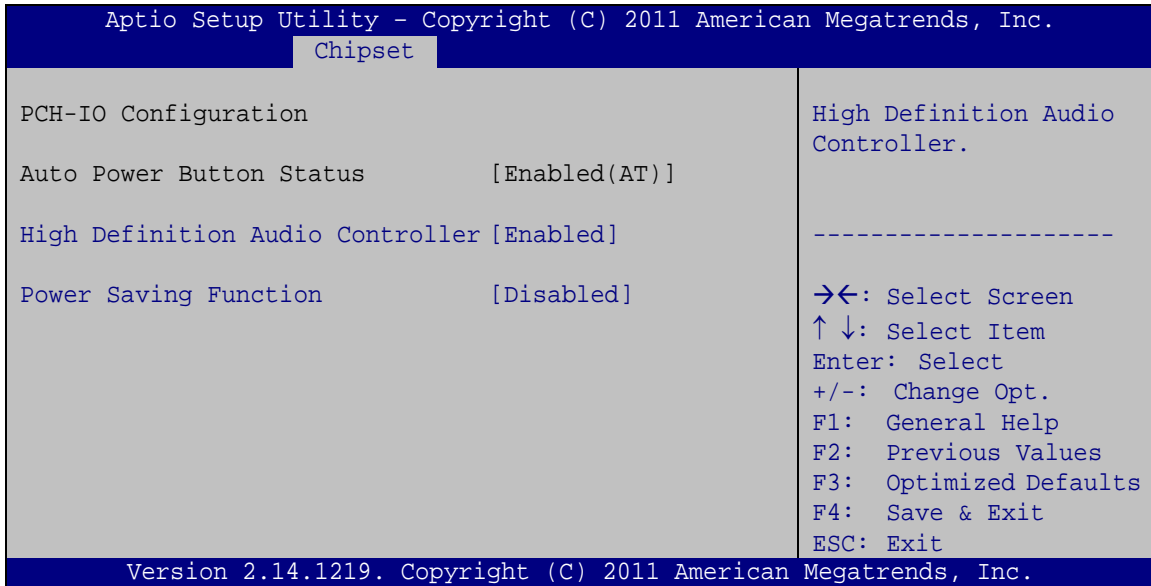

BIOS Menu 21: PCH-IO Configuration

→ High Definition Audio Controller [Enabled]

Use the **High Definition Audio Controller** BIOS option to enable or disable the High Definition Audio controller.

- **Disabled** The onboard High Definition Audio controller is disabled
- **Enabled** **DEFAULT** The onboard High Definition Audio controller automatically detected and enabled

→ Power Saving Function [Disabled]

Use the **Power Saving Function** BIOS option to enable or disable the power saving function.

- **Disabled** **DEFAULT** Power saving function is disabled.
- **Enabled** Power saving function is enabled. It will reduce power consumption when the system is off.

TANK-820-H61 Embedded System

5.4.2 System Agent (SA) Configuration

Use the **System Agent (SA) Configuration** menu (**BIOS Menu 22**) to configure the graphics setting and memory setting.

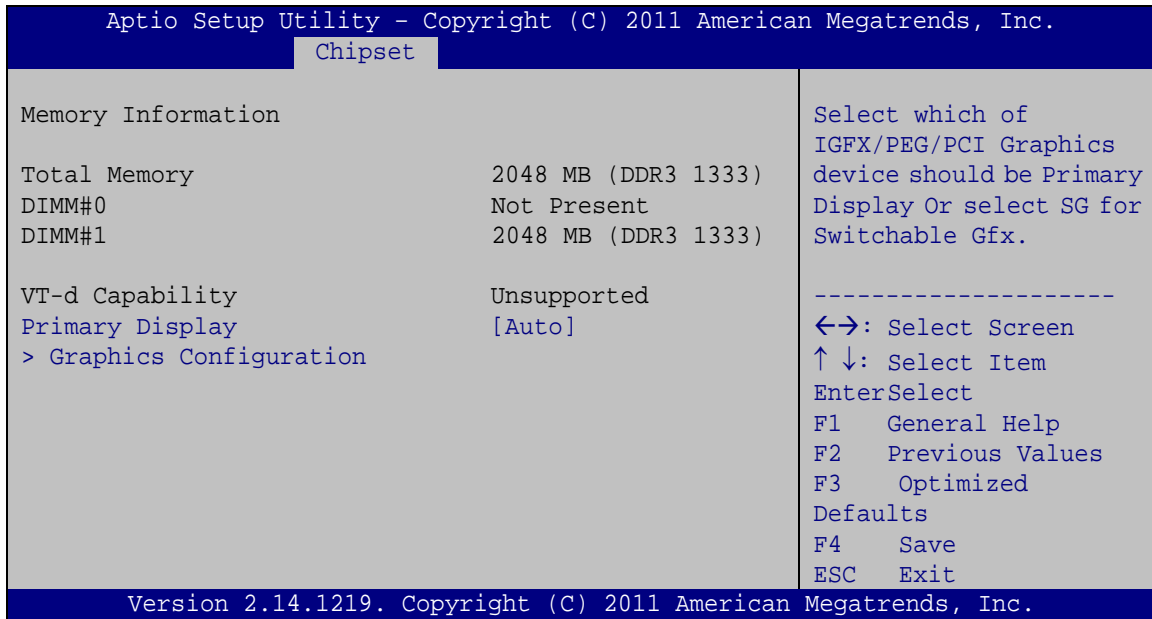

BIOS Menu 22: System Agent (SA) Configuration

→ Primary Display [Auto]

Use the **Primary Display** option to select the display device used by the system when it boots. Configuration options are listed below.

- Auto **DEFAULT**
- IGFX
- PEG
- PCI
- SG

5.4.2.1 Graphics Configuration

Use the **Graphics Configuration** menu (**BIOS Menu 23**) to configure the video device connected to the system.

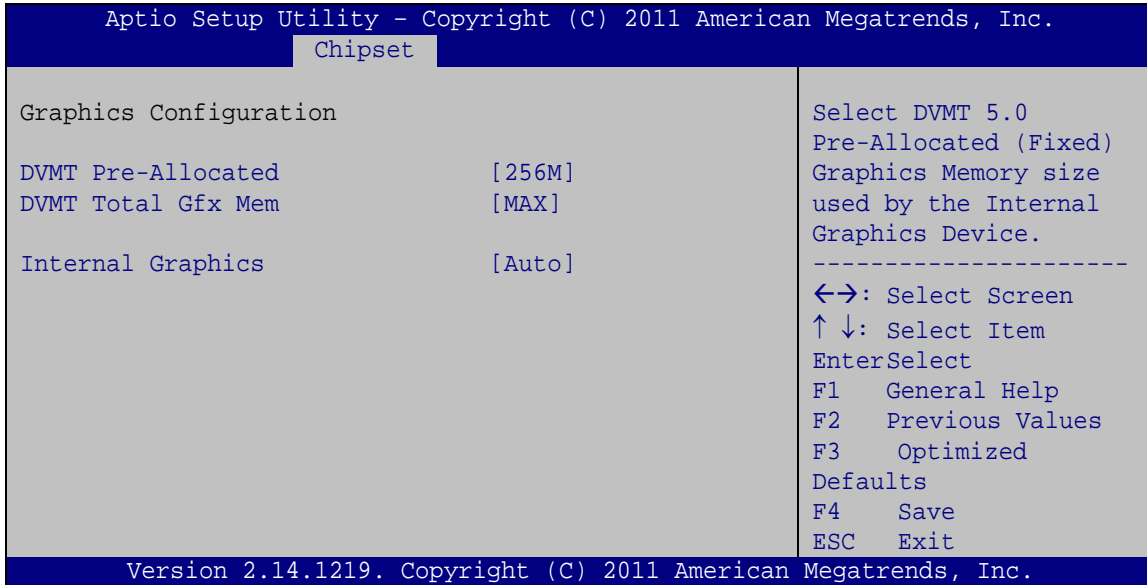

BIOS Menu 23: Graphics Configuration

→ DVMT Pre-Allocated [256MB]

Use the **DVMT Pre-Allocated** option to set the amount of system memory allocated to the integrated graphics processor when the system boots. The system memory allocated can then only be used as graphics memory, and is no longer available to applications or the operating system. Configuration options are listed below:

- 32M
- 64M
- 128M
- 256M **Default**
- 512M

→ DVMT Total Gfx Mem [MAX]

Use the **DVMT Total Gfx Mem** option to select DVMT5.0 total graphic memory size used by the internal graphic device. The following options are available:

- 128M
- 256M
- MAX **Default**

TANK-820-H61 Embedded System

→ Internal Graphics [Auto]

Use the **Internal Graphics** option to keep IGD enabled based on the setup option. The following options are available:

- Auto **Default**
- Disabled
- Enabled

5.5 Boot

Use the **Boot** menu (**BIOS Menu 24**) to configure system boot options.

```

Aptio Setup Utility - Copyright (C) 2011 American Megatrends, Inc.
Main   Advanced  Chipset  Boot   Security  Save & Exit
-----
Boot Configuration
Bootup NumLock State      [On]
Quiet Boot                 [Enabled]
Launch PXE OpROM          [Disabled]
Option ROM Messages       [Force BIOS]
UEFI Boot                 [Disabled]

Boot Option Priorities

-----
Select the keyboard NumLock state

<->: Select Screen
↑ ↓: Select Item
Enter>Select
+/-: Change Opt.
F1:  General Help
F2:  Previous Values
F3:  Optimized Defaults
F4:  Save & Exit
ESC: Exit

Version 2.14.1219. Copyright (C) 2011 American Megatrends, Inc.

```

BIOS Menu 24: Boot

→ Bootup NumLock State [On]

Use the **Bootup NumLock State** BIOS option to specify if the number lock setting must be modified during boot up.

→ **On** **DEFAULT** Allows the Number Lock on the keyboard to be enabled automatically when the computer system boots up. This allows the immediate use of the 10-key numeric keypad located on the right side of the keyboard. To confirm this, the Number Lock LED light on the keyboard is lit.

→ **Off** Does not enable the keyboard Number Lock automatically. To use the 10-keys on the keyboard, press the Number Lock key located on the upper left-hand corner of the 10-key pad. The Number Lock LED on the keyboard lights up when the Number Lock is engaged.

→ **Quiet Boot [Enabled]**

Use the **Quiet Boot** BIOS option to select the screen display when the system boots.

→ **Disabled** Normal POST messages displayed

→ **Enabled** **DEFAULT** OEM Logo displayed instead of POST messages

→ **Launch PXE OpROM [Disabled]**

Use the **Launch PXE OpROM** option to enable or disable boot option for legacy network devices.

→ **Disabled** **DEFAULT** Ignore all PXE Option ROMs

→ **Enabled** Load PXE Option ROMs.

→ **Option ROM Messages [Force BIOS]**

Use the **Option ROM Messages** option to set the Option ROM display mode.

→ **Force BIOS** **DEFAULT** Sets display mode to force BIOS.

TANK-820-H61 Embedded System

→ **Keep Current** Sets display mode to current.

→ **UEFI Boot [Disabled]**

Use the **UEFI Boot** option to enable or disable to boot from the UEFI devices.

→ **Enabled** Boot from UEFI devices is enabled.

→ **Disabled** **DEFAULT** Boot from UEFI devices is disabled.

5.6 Security

Use the **Security** menu (**BIOS Menu 25**) to set system and user passwords.

```

Aptio Setup Utility - Copyright (C) 2011 American Megatrends, Inc.
Main   Advanced  Chipset  Boot   Security  Save & Exit
-----
Password Description
If ONLY the Administrator's password is set,
then this only limits access to Setup and is
only asked for when entering Setup.
If ONLY the User's password is set, then this
is a power on password and must be entered to
boot or enter Setup. In Setup the User will
have Administrator rights.
The password length must be:
Minimum length           3
Maximum length          20

Administrator Password
User Password

Set Administrator
Password

-----
←→: Select Screen
↑↓: Select Item
EnterSelect
+/-: Change Opt.
F1:  General Help
F2:  Previous Values
F3:  Optimized Defaults
F4:  Save & Exit
ESC: Exit

Version 2.14.1219. Copyright (C) 2011 American Megatrends, Inc.

```

BIOS Menu 25: Security

→ **Administrator Password**

Use the **Administrator Password** to set or change an administrator password.

→ **User Password**

Use the **User Password** to set or change a user password.

5.7 Exit

Use the **Exit** menu (**BIOS Menu 26**) to load default BIOS values, optimal failsafe values and to save configuration changes.

```
Aptio Setup Utility - Copyright (C) 2011 American Megatrends, Inc.
Main   Advanced  Chipset   Boot     Security  Save & Exit
-----
Save Changes and Reset
Discard Changes and Reset

Restore Defaults
Save as User Defaults
Restore User Defaults

Exit the system after
saving the changes.

-----
<->: Select Screen
↑ ↓: Select Item
Enter>Select
+/-: Change Opt.
F1:  General Help
F2:  Previous Values
F3:  Optimized Defaults
F4:  Save & Exit
ESC: Exit

Version 2.14.1219. Copyright (C) 2011 American Megatrends, Inc.
```

BIOS Menu 26:Exit

→ Save Changes and Reset

Use the **Save Changes and Reset** option to save the changes made to the BIOS options and reset the system.

→ Discard Changes and Reset

Use the **Discard Changes and Reset** option to exit the system without saving the changes made to the BIOS configuration setup program.

→ Restore Defaults

Use the **Restore Defaults** option to load the optimal default values for each of the parameters on the Setup menus. **F3 key can be used for this operation.**

TANK-820-H61 Embedded System

➔ Save as User Defaults

Use the **Save as User Defaults** option to save the changes done so far as user defaults.

➔ Restore User Defaults

Use the **Restore User Defaults** option to restore the user defaults to all the setup options.

Appendix

A

One Key Recovery

A.1 One Key Recovery Introduction

The IEI one key recovery is an easy-to-use front end for the Norton Ghost system backup and recovery tool. This tool provides quick and easy shortcuts for creating a backup and reverting to that backup or reverting to the factory default settings.



NOTE:

The latest One Key Recovery software provides an auto recovery function that allows a system running Microsoft Windows OS to automatically restore from the factory default image after encountering a Blue Screen of Death (BSoD) or a hang for around 10 minutes. Please refer to Section A.3 for the detailed setup procedure.

The IEI One Key Recovery tool menu is shown below.

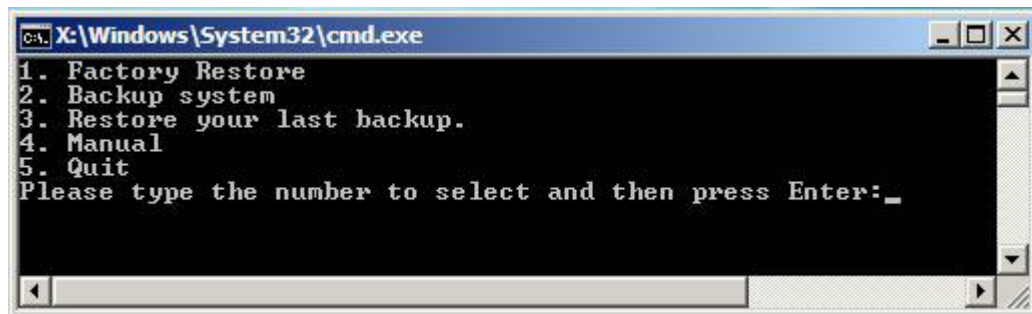

Figure A-1: IEI One Key Recovery Tool Menu

Prior to using the IEI One Key Recovery tool (as shown in **Figure A-1**) to backup or restore Windows system, five setup procedures are required.

1. Hardware and BIOS setup (see Section A.2.1)
2. Create partitions (see **Section A.2.2**)
3. Install operating system, drivers and system applications (see **Section A.2.3**)
4. Build the recovery partition (see **Section A.2.4**)
5. Create factory default image (see **Section A.2.5**)

After completing the five initial setup procedures as described above, users can access the recovery tool by pressing <F3> while booting up the system. The detailed information of each function is described in **Section A.5**.

**NOTE:**

The initial setup procedures for Linux system are described in **Section A.3**.

A.1.1 System Requirement

**NOTE:**

The recovery CD can only be used with IEI products. The software will fail to run and a warning message will appear when used on non-IEI hardware.



To create the system backup, the main storage device must be split into two partitions (three partitions for Linux). The first partition will be for the operating system, while the second partition will be invisible to the operating system and contain the backup made by the one key recovery software.

The partition created for recovery images must be big enough to contain both the factory default image and the user backup image. The size must be calculated before creating the

TANK-820-H61 Embedded System

partitions. Please take the following table as a reference when calculating the size of the partition.

	OS	OS Image after Ghost	Compression Ratio
Windows® 7	7 GB	5 GB	70%
Windows® XPE	776 MB	560 MB	70%
Windows® CE 6.0	36 MB	28 MB	77%



NOTE:

Specialized tools are required to change the partition size if the operating system is already installed.

A.1.2 Supported Operating System

The recovery CD is compatible with both Microsoft Windows and Linux operating system (OS). The supported OS versions are listed below.

- Microsoft Windows
 - Windows XP (Service Pack 2 or 3 required)
 - Windows Vista
 - Windows 7
 - Windows CE 5.0
 - Windows CE 6.0
 - Windows XP Embedded
- Linux
 - Fedora Core 12 (Constantine)
 - Fedora Core 11 (Leonidas)
 - Fedora Core 10 (Cambridge)
 - Fedora Core 8 (Werewolf)
 - Fedora Core 7 (Moonshine)
 - RedHat RHEL-5.4
 - RedHat 9 (Ghirke)

- Ubuntu 8.10 (Intrepid)
- Ubuntu 7.10 (Gutsy)
- Ubuntu 6.10 (Edgy)
- Debian 5.0 (Lenny)
- Debian 4.0 (Etch)
- SuSe 11.2
- SuSe 10.3

**NOTE:**

Installing unsupported OS versions may cause the recovery tool to fail.

A.2 Setup Procedure for Windows

Prior to using the recovery tool to backup or restore Windows system, a few setup procedures are required.

Step 1: Hardware and BIOS setup (see **Section A.2.1**)

Step 2: Create partitions (see **Section A.2.2**)

Step 3: Install operating system, drivers and system applications (see **Section A.2.3**)

Step 4: Build the recovery partition (see **Section A.2.4**) or build the auto recovery partition (see **Section A.3**)

Step 5: Create factory default image (see **Section A.2.5**)

The detailed descriptions are described in the following sections.

**NOTE:**

The setup procedures described below are for Microsoft Windows operating system users. For Linux, most of the setup procedures are the same except for several steps described in **Section A.3**.

TANK-820-H61 Embedded System

A.2.1 Hardware and BIOS Setup

- Step 1:** Make sure the system is powered off and unplugged.
- Step 2:** Install a hard drive or SSD in the system. An unformatted and unpartitioned disk is recommended.
- Step 3:** Connect an optical disk drive to the system and insert the recovery CD.
- Step 4:** Turn on the system.
- Step 5:** Press the <DELETE> key as soon as the system is turned on to enter the BIOS.
- Step 6:** Select the connected optical disk drive as the 1st boot device. (**Boot → Boot Device Priority → 1st Boot Device**).
- Step 7:** Save changes and restart the computer. Continue to the next section for instructions on partitioning the internal storage.

A.2.2 Create Partitions

To create the system backup, the main storage device must be split into two partitions (three partitions for Linux). The first partition will be for the operating system, while the second partition will be invisible to the operating system and contain the backup made by the one key recovery software.

- Step 1:** Put the recovery CD in the optical drive of the system.
- Step 2:** **Boot the system from recovery CD.** When prompted, press any key to boot from the recovery CD. It will take a while to launch the recovery tool. Please be patient!



Figure A-2: Launching the Recovery Tool

Step 3: The recovery tool setup menu is shown as below.

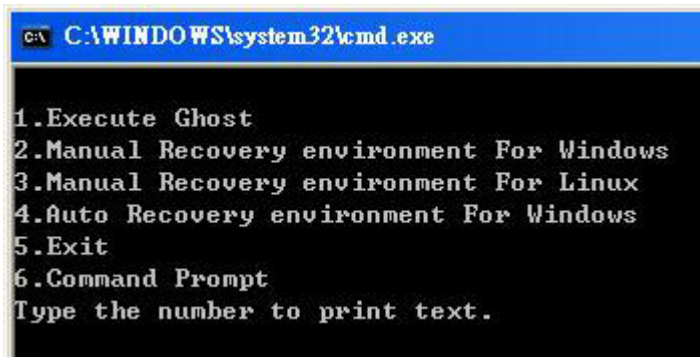
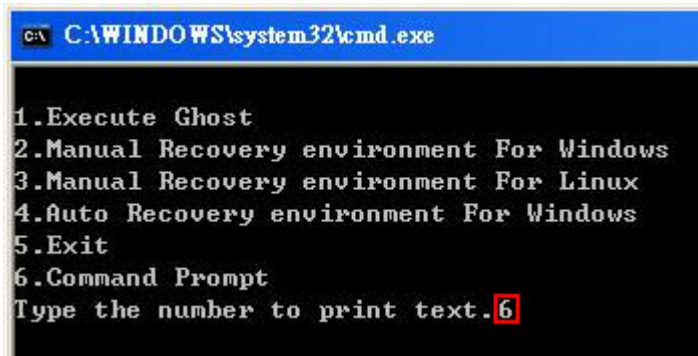

Figure A-3: Recovery Tool Setup Menu

Step 4: Press <6> then <Enter>.

TANK-820-H61 Embedded System



```
C:\WINDOWS\system32\cmd.exe

1.Execute Ghost
2.Manual Recovery environment For Windows
3.Manual Recovery environment For Linux
4.Auto Recovery environment For Windows
5.Exit
6.Command Prompt
Type the number to print text. 6
```

Figure A-4: Command Mode

Step 5: The command prompt window appears. Type the following commands (marked in red) to create two partitions. One is for the OS installation; the other is for saving recovery files and images which will be an invisible partition. (Press <Enter> after entering each line below)

```
system32>diskpart
DISKPART>list vol
DISKPART>sel disk 0
DISKPART>create part pri size= ____
DISKPART>assign letter=N
DISKPART>create part pri size= ____
DISKPART>assign letter=F
DISKPART>exit
system32>format N: /fs:ntfs /q /y
system32>format F: /fs:ntfs /q /v:Recovery /y
system32>exit
```

```

X:\I386\SYSTEM32\CMD.EXE
X:\I386\SYSTEM32>diskpart → Starts the Microsoft disk partitioning tool.
Microsoft DiskPart version 5.2.3790.1830
Copyright (C) 1999-2001 Microsoft Corporation.
On computer: MININT-JUC

DISKPART> list vol → Show partition information

Volume ### Ltr Label Fs Type Size Status Info
-----
Volume 0 X CD_ROM CDFS DUD-ROM 405 MB Healthy Boot
Volume 1 D FAT32 Removeable 3854 MB Healthy

DISKPART> sel disk 0 → Select a disk
Disk 0 is now the selected disk.

DISKPART> create part pri size=2000 → Create partition 1 and assign a size.
This partition is for OS installation.
DiskPart succeeded in creating the specified partition.

DISKPART> assign letter=N → Assign partition 1 a code name (N).
DiskPart successfully assigned the drive letter or mount point.

DISKPART> create part pri size=1800 → Create partition 2 and assign a size.
This partition is for recovery images.
DiskPart succeeded in creating the specified partition.

DISKPART> assign letter=F → Assign partition 2 a code name (F).
DiskPart successfully assigned the drive letter or mount point.

DISKPART> exit → Exit diskpart
X:\I386\SYSTEM32>format n: /fs:ntfs /q /y → Format partition 1 (N) as NTFS format.
The type of the file system is RAW.
The new file system is NTFS.
QuickFormatting 2000M
Creating file system structures.
Format complete.
2048254 KB total disk space.
2035620 KB are available.

X:\I386\SYSTEM32>format f: /fs:ntfs /q /v:Recovery /y → Formate partition 2 (F) as NTFS formate and
name it as "Recovery".
The type of the file system is RAW.
The new file system is NTFS.
QuickFormatting 1804M
Creating file system structures.
Format complete.
1847474 KB total disk space.
1835860 KB are available.

X:\I386\SYSTEM32>exit → Exit Windows PE
  
```

Figure A-5: Partition Creation Commands

**NOTE:**

Use the following commands to check if the partitions were created successfully.

```
X:\I386\SYSTEM32>diskpart
Microsoft DiskPart version 5.2.3790.1830
Copyright (C) 1999-2001 Microsoft Corporation.
On computer: MININT-JUC

DISKPART> sel disk 0
Disk 0 is now the selected disk.

DISKPART> list part

   Partition ###   Type              Size              Offset
-----
   Partition 1     Primary           2000 MB           32 KB
   Partition 2     Primary           1804 MB          2000 MB

DISKPART> exit
```

Step 6: Press any key to exit the recovery tool and automatically reboot the system.

Please continue to the following procedure: Build-up Recovery Partition.

A.2.3 Install Operating System, Drivers and Applications

Install the operating system onto the unlabelled partition. The partition labeled "Recovery" is for use by the system recovery tool and should not be used for installing the operating system or any applications.

**NOTE:**

The operating system installation program may offer to reformat the chosen partition. DO NOT format the partition again. The partition has already been formatted and is ready for installing the new operating system.

To install the operating system, insert the operating system installation CD into the optical drive. Restart the computer and follow the installation instructions.

A.2.4 Build-up Recovery Partition

- Step 1:** Put the recover CD in the optical drive.
- Step 2:** Start the system.
- Step 3:** **Boot the system from recovery CD.** When prompted, press any key to boot from the recovery CD. It will take a while to launch the recovery tool. Please be patient!

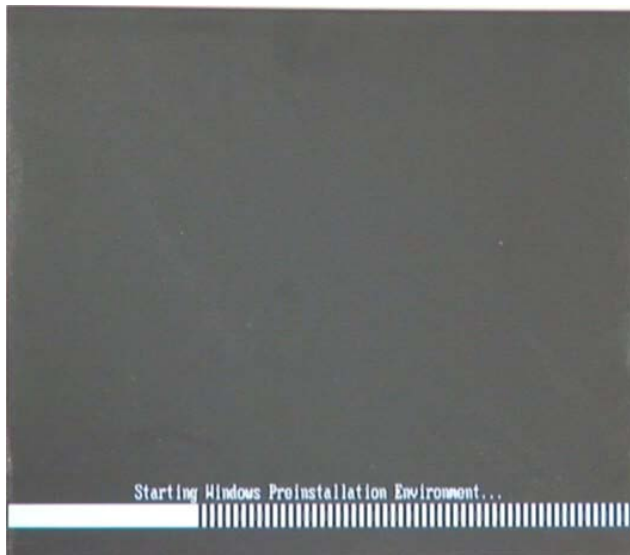

Figure A-6: Launching the Recovery Tool

- Step 4:** When the recovery tool setup menu appears, press <2> then <Enter>.

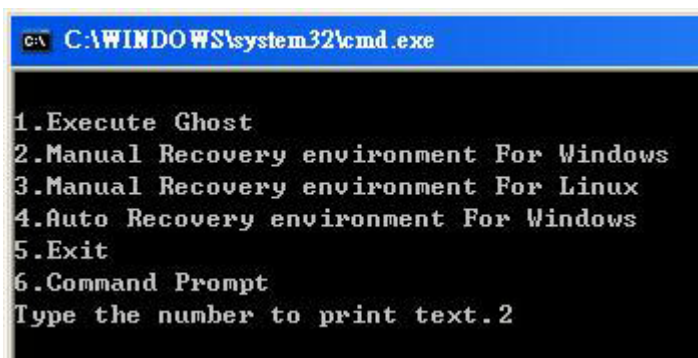

Figure A-7: System Configuration for Windows

TANK-820-H61 Embedded System

Step 5: The Symantec Ghost window appears and starts configuring the system to build a recovery partition. In this process the partition created for recovery files in **Section A.2.2** is hidden and the recovery tool is saved in this partition.

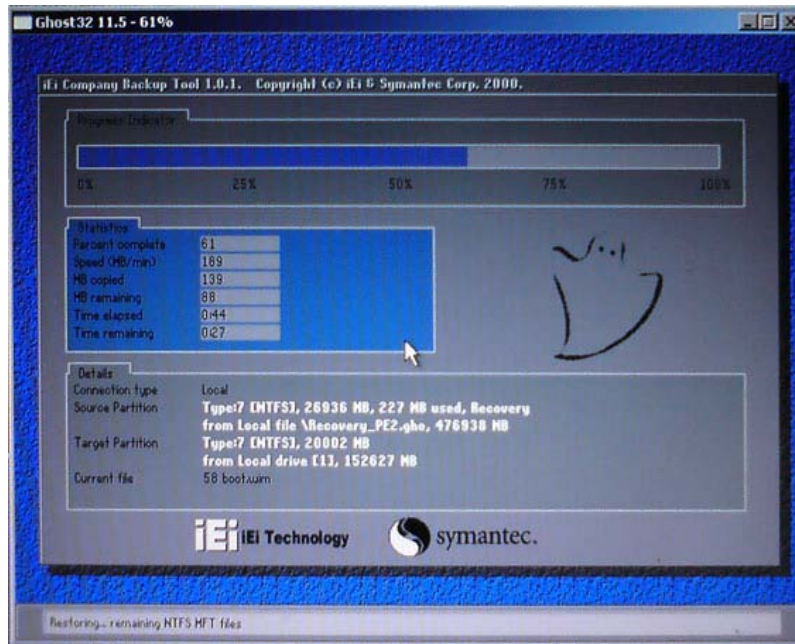

Figure A-8: Building the Recovery Partition

Step 6: After completing the system configuration, press any key in the following window to reboot the system.

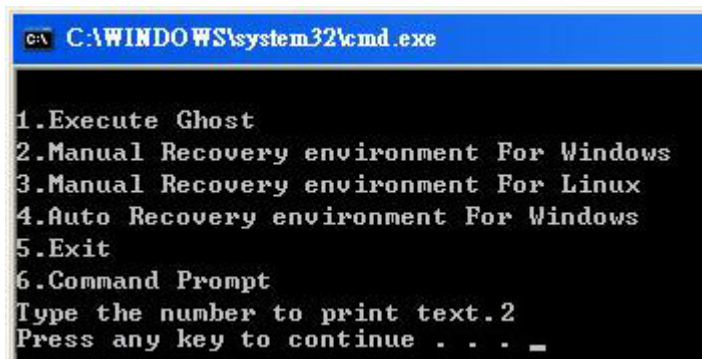

Figure A-9: Press Any Key to Continue

Step 7: Eject the recovery CD.

A.2.5 Create Factory Default Image



NOTE:

Before creating the factory default image, please configure the system to a factory default environment, including driver and application installations.

To create a factory default image, please follow the steps below.

Step 1: Turn on the system. When the following screen displays (**Figure A-10**), press the <F3> key to access the recovery tool. The message will display for 10 seconds, please press F3 before the system boots into the operating system.

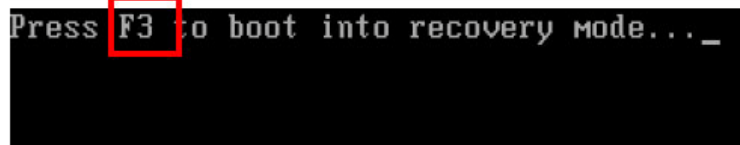

Figure A-10: Press F3 to Boot into Recovery Mode

Step 2: The recovery tool menu appears. Type <4> and press <Enter>. (**Figure A-11**)

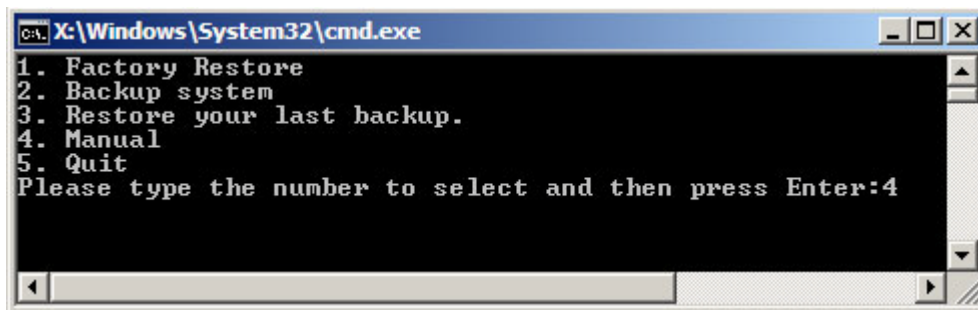

Figure A-11: Recovery Tool Menu

Step 3: The About Symantec Ghost window appears. Click **OK** button to continue.

TANK-820-H61 Embedded System

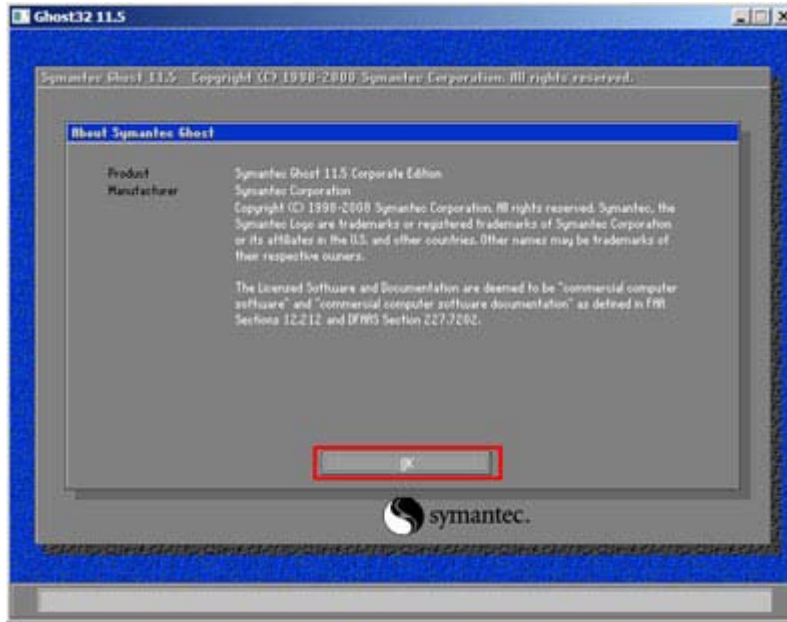

Figure A-12: About Symantec Ghost Window

Step 4: Use mouse to navigate to the option shown below (Figure A-13).

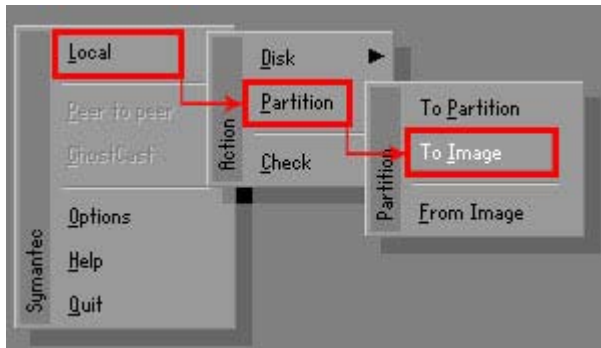

Figure A-13: Symantec Ghost Path

Step 5: Select the local source drive (Drive 1) as shown in Figure A-14. Then click OK.

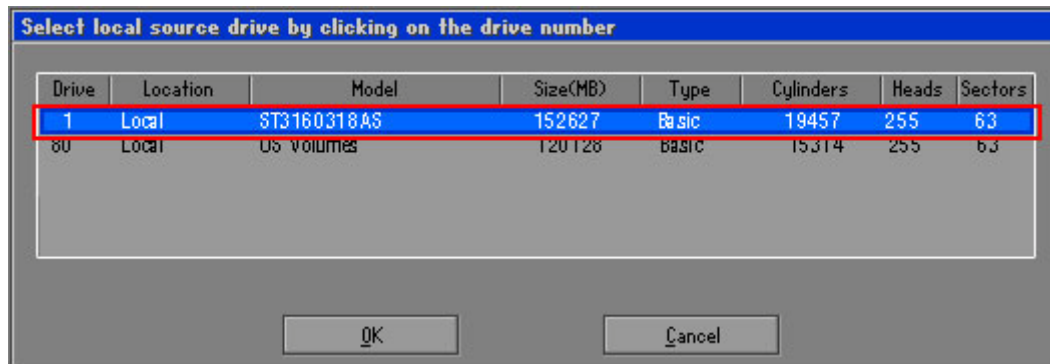

Figure A-14: Select a Local Source Drive

Step 6: Select a source partition (Part 1) from basic drive as shown in **Figure A-15**. Then click OK.

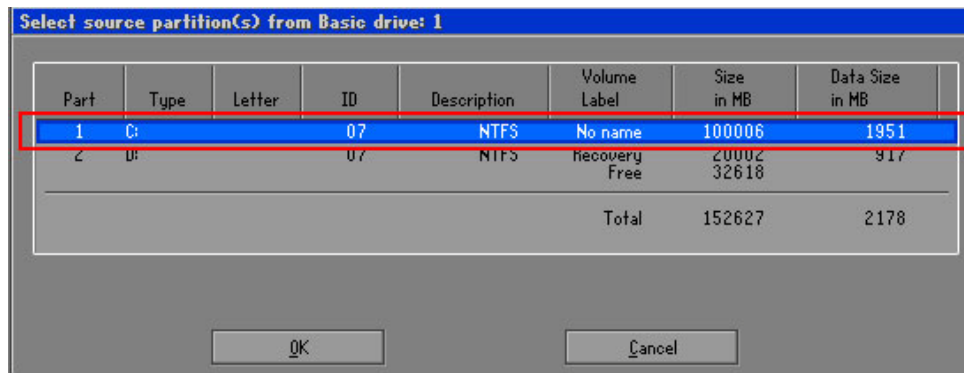

Figure A-15: Select a Source Partition from Basic Drive

Step 7: Select **1.2: [Recovery] NTFS drive** and enter a file name called **iei** (**Figure A-16**). Click **Save**. The factory default image will then be saved in the selected recovery drive and named **IEI.GHO**.



WARNING:

The file name of the factory default image must be **iei.GHO**.

TANK-820-H61 Embedded System

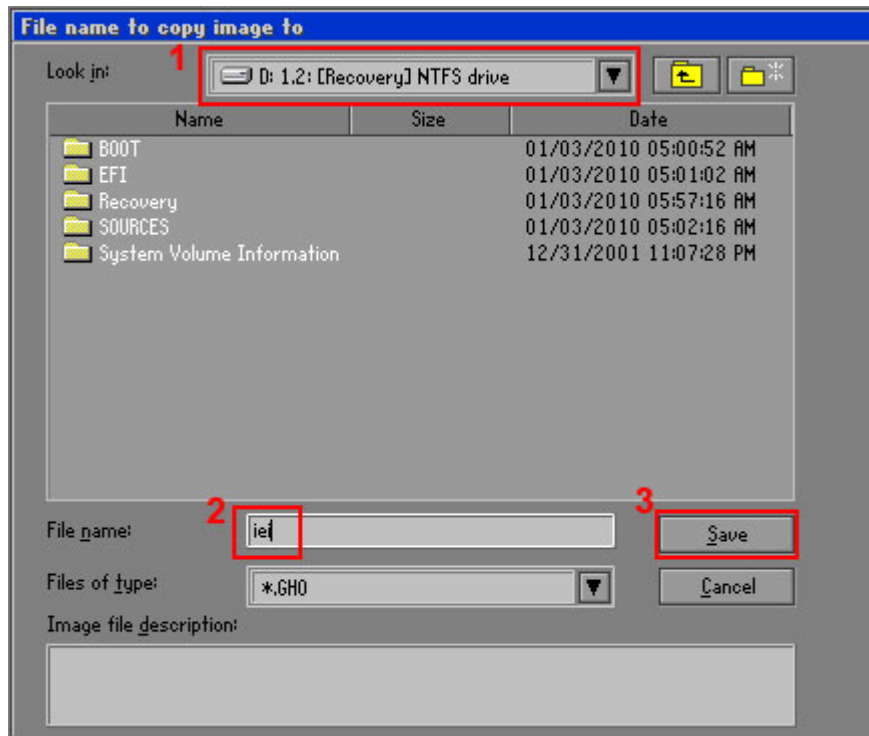

Figure A-16: File Name to Copy Image to

Step 8: When the Compress Image screen in Figure A-17 prompts, click **High** to make the image file smaller.

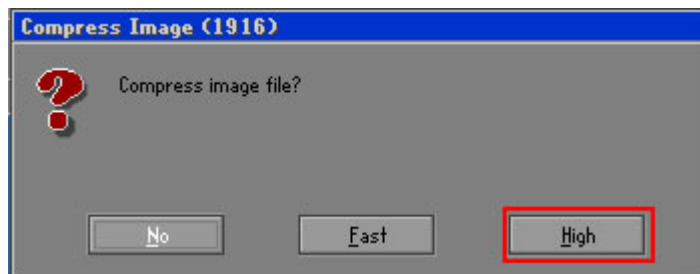

Figure A-17: Compress Image

Step 9: The Proceed with partition image creation window appears, click **Yes** to continue.

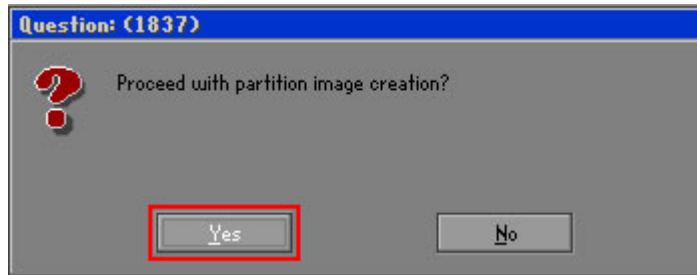

Figure A-18: Image Creation Confirmation

Step 10: The Symantec Ghost starts to create the factory default image (**Figure A-19**).

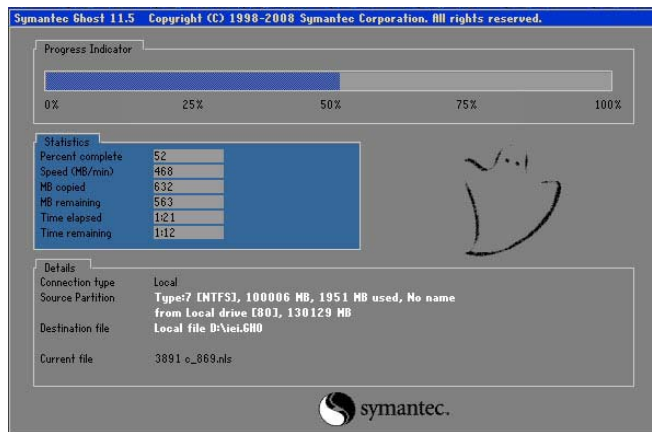

Figure A-19: Image Creation Process

Step 11: When the image creation completes, a screen prompts as shown in **Figure A-20**.

Click **Continue** and close the Ghost window to exit the program.



Figure A-20: Image Creation Complete

TANK-820-H61 Embedded System

Step 12: The recovery tool main menu window is shown as below. Press any key to reboot the system.

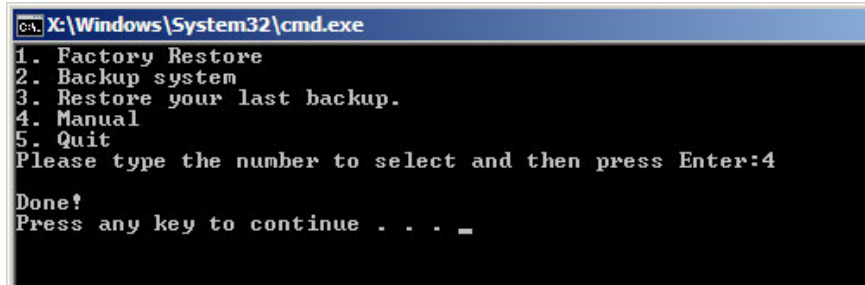
A screenshot of a Windows command prompt window. The title bar reads "C:\Windows\System32\cmd.exe". The window content shows a numbered menu:

```
1. Factory Restore
2. Backup system
3. Restore your last backup.
4. Manual
5. Quit
Please type the number to select and then press Enter:4
Done!
Press any key to continue . . . _
```

Figure A-21: Press Any Key to Continue

A.3 Auto Recovery Setup Procedure

The auto recovery function allows a system to automatically restore from the factory default image after encountering a Blue Screen of Death (BSoD) or a hang for around 10 minutes. To use the auto recovery function, follow the steps described in the following sections.



CAUTION:

The setup procedure may include a step to create a factory default image. It is suggested to configure the system to a factory default environment before the configuration, including driver and application installations.

Step 1: Follow the steps described in **Section A.2.1 ~ Section A.2.3** to setup BIOS, create partitions and install operating system.

Step 2: Install the auto recovery utility into the system by double clicking the **Utility/AUTORECOVERY-SETUP.exe** in the One Key Recovery CD. This utility **MUST** be installed in the system, otherwise, the system will automatically restore from the factory default image every ten (10) minutes.



Figure A-22: Auto Recovery Utility

Step 3: Reboot the system from the recovery CD. When prompted, press any key to boot from the recovery CD. It will take a while to launch the recovery tool. Please be patient!

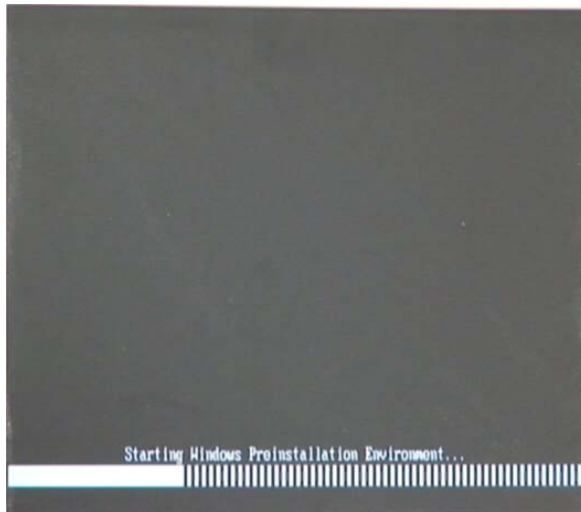

Figure A-23: Launching the Recovery Tool

Step 4: When the recovery tool setup menu appears, press <4> then <Enter>.

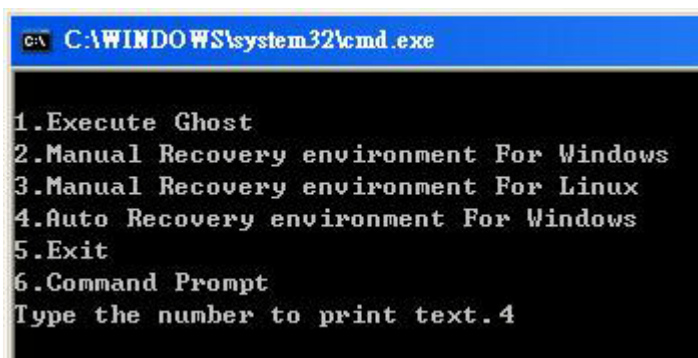

Figure A-24: Auto Recovery Environment for Windows

TANK-820-H61 Embedded System

- Step 5:** The Symantec Ghost window appears and starts configuring the system to build an auto recovery partition. In this process the partition created for recovery files in **Section A.2.2** is hidden and the auto recovery tool is saved in this partition.

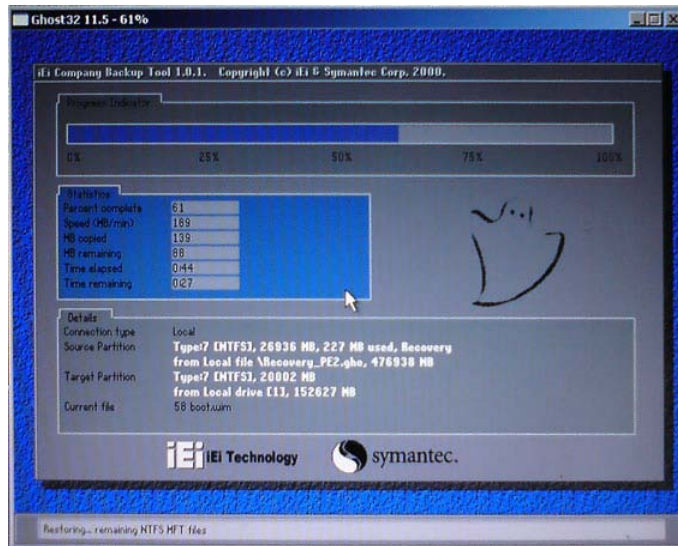

Figure A-25: Building the Auto Recovery Partition

- Step 6:** After completing the system configuration, the following message prompts to confirm whether to create a factory default image. Type **Y** to have the system create a factory default image automatically. Type **N** within 6 seconds to skip this process (The default option is YES). It is suggested to choose YES for this option.



Figure A-26: Factory Default Image Confirmation

Step 7: The Symantec Ghost starts to create the factory default image (**Figure A-27**).

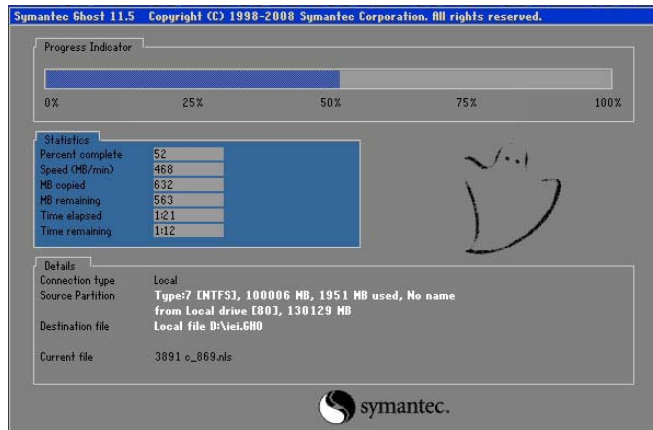

Figure A-27: Image Creation Complete

Step 8: After completing the system configuration, press any key in the following window to restart the system.

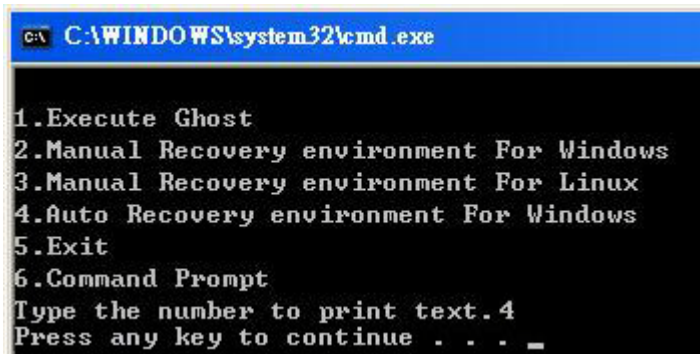

Figure A-28: Press any key to continue

Step 9: Eject the One Key Recovery CD and restart the system.

Step 10: Press the <DELETE> key as soon as the system is turned on to enter the BIOS.

Step 11: Enable the Auto Recovery Function option (**Advanced** → **iEi Feature** → **Auto Recovery Function**).

TANK-820-H61 Embedded System

```

BIOS SETUP UTILITY
Main  Advanced  PCIPNP  Boot  Security  Chipset  Exit
-----
iEi Feature
-----
Auto Recovery Function      [Enabled]
  Recover from PXE         [Disabled]

                                  ←→  Select Screen
                                  ↑↓  Select Item
                                  Enter Go to SubScreen
                                  F1   General Help
                                  F10  Save and Exit
                                  ESC  Exit

v02.61 ©Copyright 1985-2006, American Megatrends, Inc.

```

BIOS Menu 27: IEI Feature

Step 12: Save changes and restart the system. If the system encounters a Blue Screen of Death (BSoD) or a hang for around 10 minutes, it will automatically restore from the factory default image.

**CAUTION:**

The auto recovery function can only apply on a Microsoft Windows system running the following OS versions:

- Windows XP
- Windows Vista
- Windows 7

A.4 Setup Procedure for Linux

The initial setup procedures for a Linux system are mostly the same with the procedure for Microsoft Windows. Please follow the steps below to setup the recovery tool for Linux OS.

Step 1: **Hardware and BIOS setup.** Refer to **Section A.2.1.**

Step 2: Install Linux operating system. Make sure to install GRUB (v0.97 or earlier) MBR type and Ext3 partition type. Leave enough space on the hard drive to create the recover partition later.

**NOTE:**

If the Linux OS is not installed with GRUB (v0.97 or earlier) and Ext3, the Symantec Ghost may not function properly.

While installing Linux OS, please create two partitions:

- Partition 1: /
- Partition 2: **SWAP**

**NOTE:**

Please reserve enough space for partition 3 for saving recovery images.

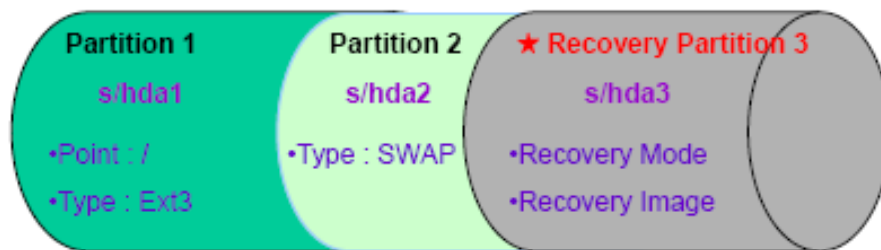

Figure A-29: Partitions for Linux

Step 3: Create a recovery partition. Insert the recovery CD into the optical disk drive. Follow **Step 1 ~ Step 3** described in **Section A.2.2**. Then type the following commands (marked in red) to create a partition for recovery images.

```
system32>diskpart
```

```
DISKPART>list vol
```

```
DISKPART>sel disk 0
```

TANK-820-H61 Embedded System

```
DISKPART>create part pri size= ____  
DISKPART>assign letter=N  
DISKPART>exit  
system32>format N: /fs:ntfs /q /v:Recovery /y  
system32>exit
```

- Step 4:** **Build-up recovery partition.** Press any key to boot from the recovery CD. It will take a while to launch the recovery tool. Please be patient. When the recovery tool setup menu appears, type <3> and press <Enter> (**Figure A-30**). The Symantec Ghost window appears and starts configuring the system to build-up a recovery partition. After completing the system configuration, press any key to reboot the system. Eject the recovery CD.

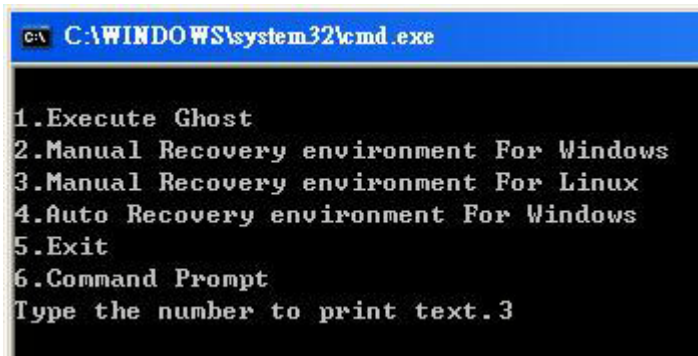

```
C:\WINDOWS\system32\cmd.exe  
1.Execute Ghost  
2.Manual Recovery environment For Windows  
3.Manual Recovery environment For Linux  
4.Auto Recovery environment For Windows  
5.Exit  
6.Command Prompt  
Type the number to print text.3
```

Figure A-30: Manual Recovery Environment for Linux

- Step 5:** **Access the recovery tool main menu by modifying the “menu.lst”.** To first access the recovery tool main menu, the menu.lst must be modified. In Linux system, enter Administrator (root). When prompt appears, type:

```
cd /boot/grub  
vi menu.lst
```



```
Fedora release 9 (Sulphur)
Kernel 2.6.25-14.fc9.i686 on an i686 (tty2)

localhost login: root
Password:
[root@localhost ~]# cd /boot/grub/
[root@localhost grub]# vi menu.lst _
```

Figure A-31: Access menu.lst in Linux (Text Mode)

Step 6: Modify the menu.lst as shown below.

```
#boot=/dev/sda
default=0
timeout=10 ← Modify timeout=10
splashimage=(hd0,0)/grub/splash.xpm.gz
hiddenmenu
title Fedora (2.6.25-14.fc9.i686)
    root (hd0,0)
    kernel /vmlinuz-2.6.25-14.fc9.i686 ro root=UUID=10f1acda
    ac38b5c78910 rhgb quiet
    initrd /initrd-2.6.25-14.fc9.i686.img

title Recovery Partition
root (hd0,2) ← Type command
makeactive
chainloader +1
```

- Type command:
title Recovery Partition
root (hd0,2)
makeactive
chainloader +1

Step 7: The recovery tool menu appears. (Figure A-32)

```
1. Factory Restore
2. Backup system
3. Restore your last backup.
4. Manual
5. Quit
Please type the number to select and then press Enter:
```

Figure A-32: Recovery Tool Menu

Step 8: Create a factory default image. Follow Step 2 ~ Step 12 described in Section A.2.5 to create a factory default image.

A.5 Recovery Tool Functions

After completing the initial setup procedures as described above, users can access the recovery tool by pressing <F3> while booting up the system. However, if the setup procedure in Section A.3 has been completed and the auto recovery function is enabled, the system will automatically restore from the factory default image without pressing the F3 key. The recovery tool main menu is shown below.

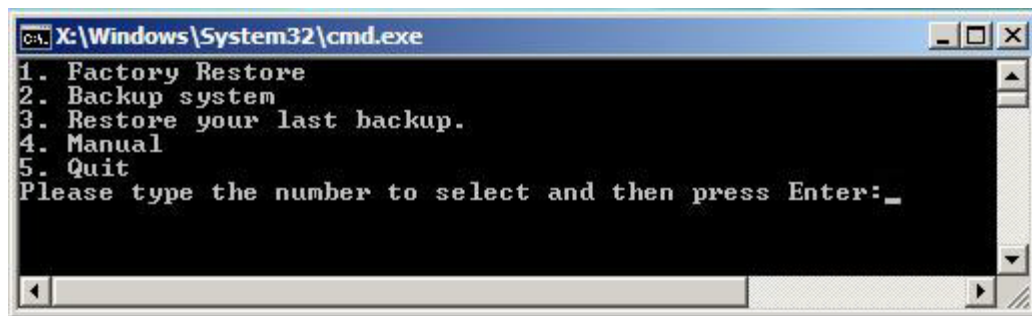

Figure A-33: Recovery Tool Main Menu

The recovery tool has several functions including:

1. **Factory Restore:** Restore the factory default image (iei.GHO) created in **Section A.2.5**.
2. **Backup system:** Create a system backup image (iei_user.GHO) which will be saved in the hidden partition.
3. **Restore your last backup:** Restore the last system backup image
4. **Manual:** Enter the Symantec Ghost window to configure manually.
5. **Quit:** Exit the recovery tool and restart the system.



WARNING:

Please do not turn off the system power during the process of system recovery or backup.

**WARNING:**

All data in the system will be deleted during the system recovery. Please backup the system files before restoring the system (either Factory Restore or Restore Backup).

A.5.1 Factory Restore

To restore the factory default image, please follow the steps below.

Step 1: Type <1> and press <Enter> in the main menu.

Step 2: The Symantec Ghost window appears and starts to restore the factory default. A factory default image called **iei.GHO** is created in the hidden Recovery partition.

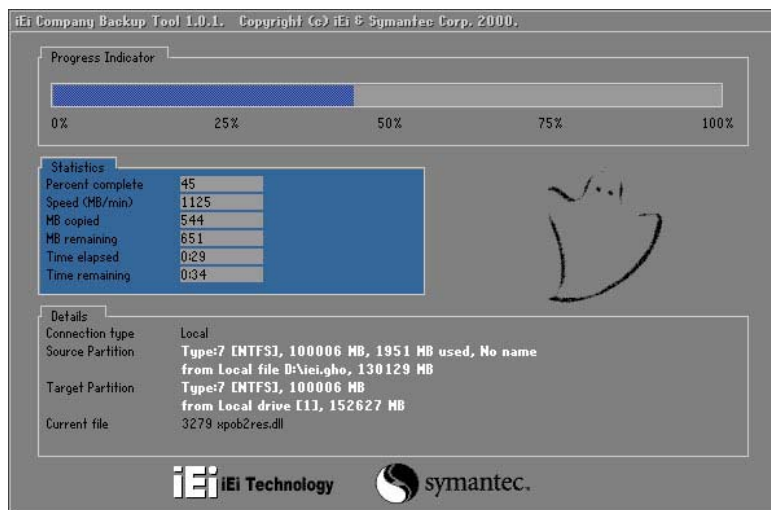

Figure A-34: Restore Factory Default

Step 3: The screen is shown as in **Figure A-35** when completed. Press any key to reboot the system.

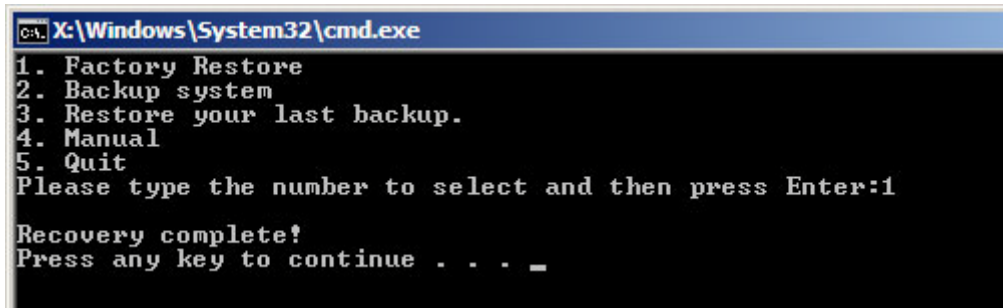

Figure A-35: Recovery Complete Window

A.5.2 Backup System

To backup the system, please follow the steps below.

Step 1: Type <2> and press <Enter> in the main menu.

Step 2: The Symantec Ghost window appears and starts to backup the system. A backup image called **iei_user.GHO** is created in the hidden Recovery partition.

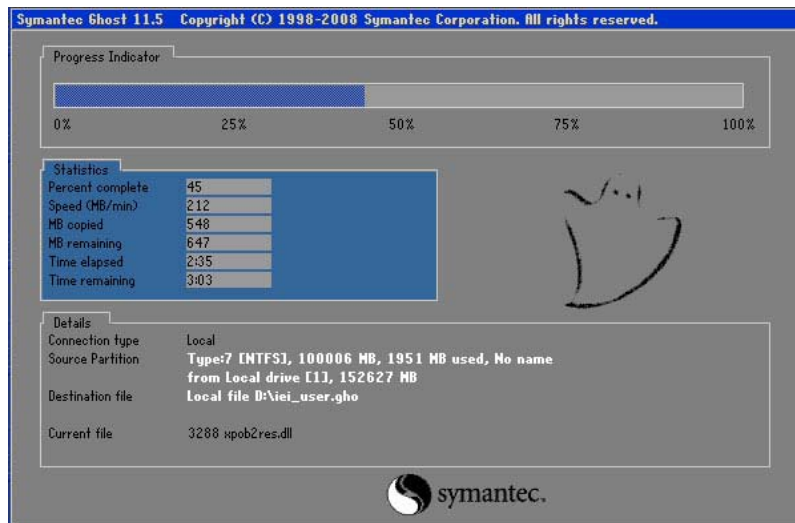

Figure A-36: Backup System

Step 3: The screen is shown as in **Figure A-37** when system backup is completed.

Press any key to reboot the system.

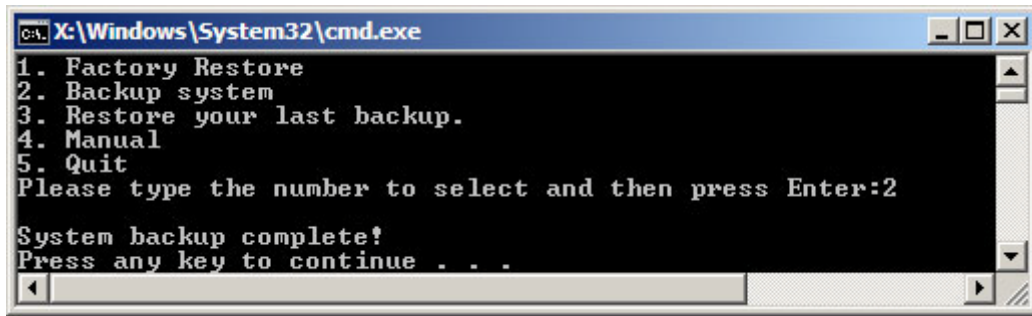

Figure A-37: System Backup Complete Window

A.5.3 Restore Your Last Backup

To restore the last system backup, please follow the steps below.

Step 1: Type <3> and press <Enter> in the main menu.

Step 2: The Symantec Ghost window appears and starts to restore the last backup image (iei_user.GHO).

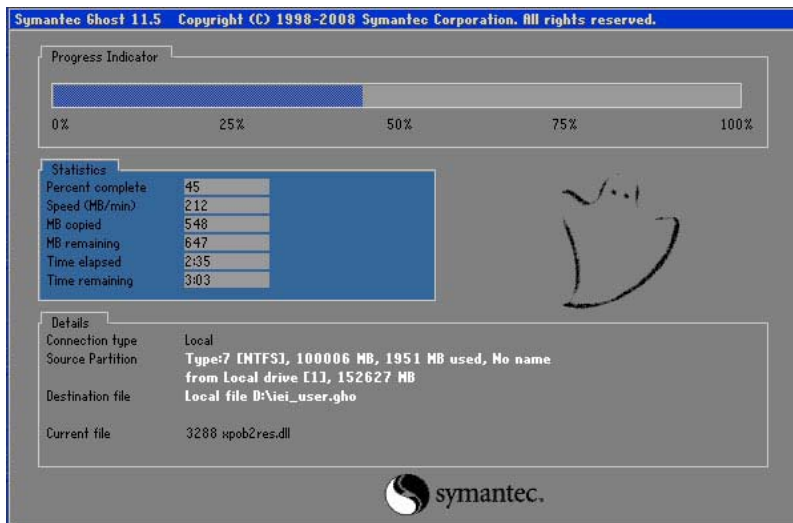
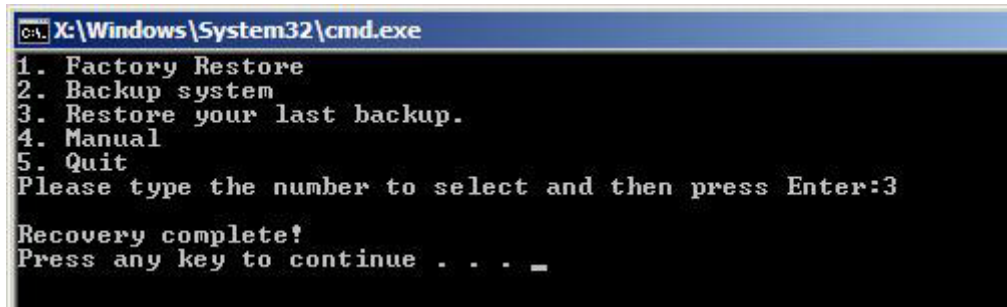

Figure A-38: Restore Backup

Step 3: The screen is shown as in **Figure A-39** when backup recovery is completed. Press any key to reboot the system.

TANK-820-H61 Embedded System



```
C:\X:\Windows\System32\cmd.exe
1. Factory Restore
2. Backup system
3. Restore your last backup.
4. Manual
5. Quit
Please type the number to select and then press Enter:3
Recovery complete!
Press any key to continue . . . _
```

Figure A-39: Restore System Backup Complete Window

A.5.4 Manual

To restore the last system backup, please follow the steps below.

Step 1: Type <4> and press <Enter> in the main menu.

Step 2: The Symantec Ghost window appears. Use the Ghost program to backup or recover the system manually.

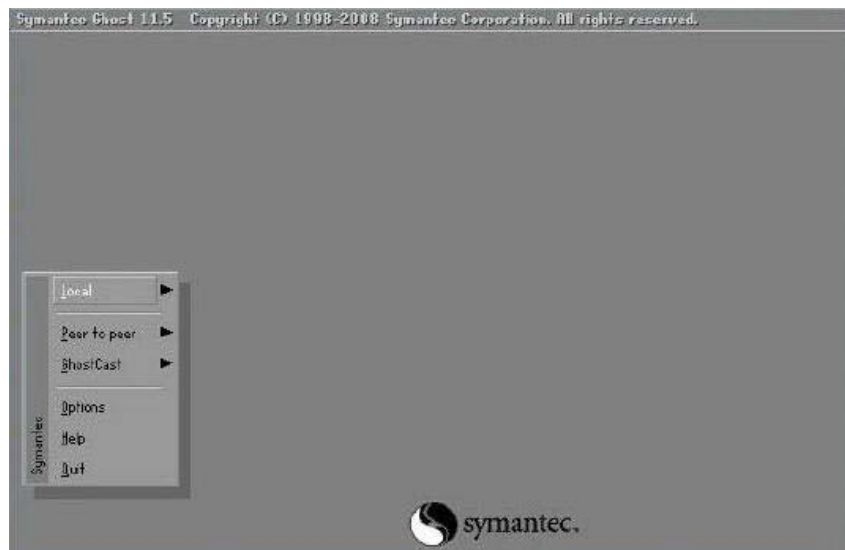
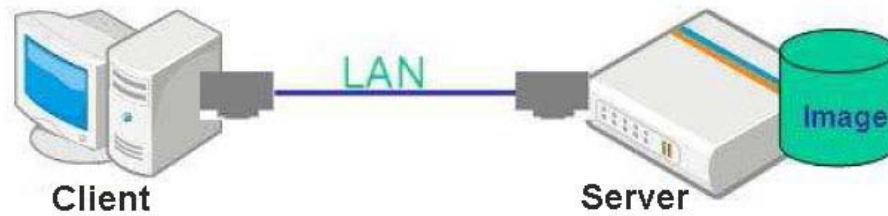

Figure A-40: Symantec Ghost Window

Step 3: When backup or recovery is completed, press any key to reboot the system.

A.6 Restore Systems from a Linux Server through LAN

The One Key Recovery allows a client system to automatically restore to a factory default image saved in a Linux system (the server) through LAN connectivity after encountering a Blue Screen of Death (BSOD) or a hang for around 10 minutes. To be able to use this function, the client system and the Linux system MUST reside in the same domain.



NOTE:

The supported client OS includes:

- Windows 2000
- Windows XP
- Windows Vista
- Windows 7
- Windows CE
- Windows XP Embedded

Prior to restoring client systems from a Linux server, a few setup procedures are required.

Step 1: Configure DHCP server settings

Step 2: Configure TFTP settings

Step 3: Configure One Key Recovery server settings

Step 4: Start DHCP, TFTP and HTTP

Step 5: Create a shared directory

Step 6: Setup a client system for auto recovery

The detailed descriptions are described in the following sections. In this document, two types of Linux OS are used as examples to explain the configuration process – CentOS 5.5 (Kernel 2.6.18) and Debian 5.0.7 (Kernel 2.6.26).

TANK-820-H61 Embedded System

A.6.1 Configure DHCP Server Settings

Step 1: Install the DHCP

`#yum install dhcp` (CentOS, commands marked in red)

`#apt-get install dhcp3-server` (Debian, commands marked in blue)

Step 2: Confirm the operating system default settings: dhcpd.conf.

CentOS

Use the following command to show the DHCP server sample location:

`#vi /etc/dhcpd.conf`

The DHCP server sample location is shown as below:

```
# DHCP Server Configuration file.
# see /usr/share/doc/dhcp*/dhcpd.conf.sample
#
```

Use the following command to copy the DHCP server sample to etc/dhcpd.conf:

`#cp /usr/share/doc/dhcp-3.0.5/dhcpd.conf.sample /etc/dhcpd.conf`

`#vi /etc/dhcpd.conf`

```
ddns-update-style interim;
ignore client-updates;

subnet 192.168.0.0 netmask 255.255.255.0 {
# --- default gateway
    option routers          192.168.0.2;
    option subnet-mask     255.255.255.0;

    option nis-domain      "domain.org";
    option domain-name     "domain.org";
    option domain-name-servers 192.168.0.1;
    next-server 192.168.0.6;
    filename "pxelinux.0";
    option time-offset     -18000; # Eastern Standard Time
    option ntp-servers     192.168.1.1;
    #
```

Debian

`#vi /etc/dhcpd.conf`

Edit “/etc/dhcpd.conf” for your environment. For example, add

`next-server PXE server IP address;`

filename "pxelinux.0";

```
ddns-update-style interim;
ignore client-updates;

subnet 192.168.0.0 netmask 255.255.255.0 {
# --- default gateway
    option routers                192.168.0.2;
    option subnet-mask            255.255.255.0;

    option nis-domain             "domain.org";
    option domain-name            "domain.org";
    option domain-name-servers   192.168.0.1;
    next-server 192.168.0.6;
    filename "pxelinux.0";
    option time-offset            -18000; # Eastern Standard Time
    option ntp-servers            192.168.1.1;
}
```

A.6.2 Configure TFTP Settings

Step 1: Install the tftp, httpd and syslinux.

```
#yum install tftp-server httpd syslinux (CentOS)
```

```
#apt-get install tftpd-hpa xinetd syslinux (Debian)
```

Step 2: Enable the TFTP server by editing the "/etc/xinetd.d/tftp" file and make it use the remap file. The "-vvv" is optional but it could definitely help on getting more information while running the remap file. For example:

CentOS

```
#vi /etc/xinetd.d/tftp
```

Modify:

```
disable = no
```

```
server_args = -s /tftpboot -m /tftpboot/tftpd.remap -vvv_
```

```
socket_type      = dgram
protocol         = udp
wait            = yes
user            = root
server          = /usr/sbin/in.tftpd
server_args     = -s /tftpboot -m /tftpboot/tftpd.remap -vvv
disable         = no
per_source      = 11
cps             = 100 2
flags           = IPv4
```

TANK-820-H61 Embedded System

Debian

Replace the TFTP settings from “inetd” to “xinetd” and annotate the “inetd” by adding “#”.

`#vi /etc/inetd.conf`

Modify: `#tftp dgram udp wait root /usr/sbin.....` (as shown below)

```
#:BOOT: TFTP service is provided primarily for booting. Most sites
#      run this only on machines acting as "boot servers."
#tftp  dgram  udp   wait  root  /usr/sbin/in.tftpd /usr/sbin/in.tftpd -s
#      /var/lib/tftpboot
```

`#vi /etc/xinetd.d/tftp`

```
socket_type      = dgram
protocol        = udp
wait            = yes
user            = root
server          = /usr/sbin/in.tftpd
server_args     = -s /tftpboot -m /tftpboot/tftpd.remap -vvv
disable         = no
per_source      = 11
cps             = 100 2
flags           = IPv4
```

A.6.3 Configure One Key Recovery Server Settings

Step 1: Copy the **Utility/RECOVERYR10.TAR.BZ2** package from the One Key Recovery CD to the system (server side).



Step 2: Extract the recovery package to /.

```
#cp RecoveryR10.tar.bz2 /
#cd /
#tar -xvjf RecoveryR10.tar.bz2
```

Step 3: Copy “pxelinux.0” from “syslinux” and install to “tftpboot”.

```
#cp /usr/lib/syslinux/pxelinux.0 /tftpboot/
```

A.6.4 Start the DHCP, TFTP and HTTP

Start the DHCP, TFTP and HTTP. For example:

CentOS

```
#service xinetd restart
```

```
#service httpd restart
```

```
#service dhcpd restart
```

Debian

```
#/etc/init.d/xinetd reload
```

```
#/etc/init.d/xinetd restart
```

```
#/etc/init.d/dhcp3-server restart
```

A.6.5 Create Shared Directory

Step 1: Install the samba.

```
#yum install samba
```

Step 2: Create a shared directory for the factory default image.

```
#mkdir /share
```

```
#cd /share
```

```
#mkdir /image
```

```
#cp iei.gho /image
```



WARNING:

The file name of the factory default image must be **iei.gho**.

Step 3: Confirm the operating system default settings: smb.conf.

```
#vi /etc/samba/smb.conf
```

TANK-820-H61 Embedded System

Modify:

[image]

comment = One Key Recovery

path = /share/image

browseable = yes

writable = yes

public = yes

create mask = 0644

directory mask = 0755

Step 4: Edit "/etc/samba/smb.conf" for your environment. For example:

```
# "security = user" is always a good idea. This will require a Unix account
# in this server for every user accessing the server. See
# /usr/share/doc/samba-doc/htmldocs/Samba3-HOWTO/ServerType.html
# in the samba-doc package for details.
security = share
```

```
[image]
comment = One Key Recovery
path = /share/image
browseable = yes
writable = yes
public = yes
create mask = 0644
directory mask = 0755
```

Step 5: Modify the hostname

```
#vi /etc/hostname
```

Modify: RecoveryServer

```
RecoveryServer
```

A.6.6 Setup a Client System for Auto Recovery

Step 1: Configure the following BIOS options of the client system.

Advanced → iEi Feature → Auto Recovery Function → **Enabled**

Advanced → iEi Feature → Recover from PXE → **Enabled**

Boot → Launch PXE OpROM → **Enabled**

Step 2: Continue to configure the **Boot Option Priorities** BIOS option of the client system:

Boot Option #1 → remain the default setting to boot from the original OS.

Boot Option #2 → select the boot from LAN option.

Step 3: Save changes and exit BIOS menu.

Exit → **Save Changes and Exit**

Step 4: Install the auto recovery utility into the system by double clicking the **Utility/AUTORECOVERY-SETUP.exe** in the One Key Recovery CD. This utility **MUST** be installed in the system, otherwise, the system will automatically restore from the factory default image every ten (10) minutes.



Step 5: Restart the client system from LAN. If the system encounters a Blue Screen of Death (BSoD) or a hang for around 10 minutes, it will automatically restore from the factory default image. The following screens will show when the system starts auto recovering.

```
Realtek PCIe GBE Family Controller Series v2.35 (06/14/10)
CLIENT MAC ADDR: 00 18 7D 13 E6 89  GUID: 00020003-0004-0005-0006-0007000000
DHCP . ./
```

TANK-820-H61 Embedded System

```

My IP address seems to be C0A80009 192.168.0.9
ip=192.168.0.9:192.168.0.8:192.168.0.2:255.255.255.0
TFTP prefix:
Trying to load: pxelinux.cfg/00020003-0004-0005-0006-000700080009
Trying to load: pxelinux.cfg/01-00-18-7d-13-e6-89
Trying to load: pxelinux.cfg/C0A80009
Trying to load: pxelinux.cfg/C0A8000
Trying to load: pxelinux.cfg/C0A800
Trying to load: pxelinux.cfg/C0A80
Trying to load: pxelinux.cfg/C0A8
Trying to load: pxelinux.cfg/C0A
Trying to load: pxelinux.cfg/C0
Trying to load: pxelinux.cfg/C
Trying to load: pxelinux.cfg/default
boot:
  
```

Windows is loading files...

IP: 192.168.0.8, File: \Boot\WinPE.wim

Symantec Ghost 11.5 Copyright (C) 1998-2008 Symantec Corporation. All rights reserved.

Progress Indicator

0% 25% 50% 75% 100%

Statistics

Percent complete	52
Speed (MB/min)	468
MB copied	632
MB remaining	563
Time elapsed	1:21
Time remaining	1:12

Details

Connection type	Local
Source Partition	Type:7 [NTFS], 100006 MB, 1951 MB used, No name from Local drive [80], 130129 MB
Destination file	Local file D:\iei.GHO
Current file	3891 e_869.nls

 symantec.



NOTE:

A firewall or a SELinux is not in use in the whole setup process. If there is a firewall or a SELinux protecting the system, modify the configuration information to accommodate them.

A.7 Other Information

A.7.1 Using AHCI Mode or ALi M5283 / VIA VT6421A Controller

When the system uses AHCI mode or some specific SATA controllers such as ALi M5283 or VIA VT6421A, the SATA RAID/AHCI driver must be installed before using one key recovery. Please follow the steps below to install the SATA RAID/AHCI driver.

Step 1: Copy the SATA RAID/AHCI driver to a floppy disk and insert the floppy disk into a USB floppy disk drive. The SATA RAID/AHCI driver must be especially designed for the on-board SATA controller.

Step 2: Connect the USB floppy disk drive to the system.

Step 3: Insert the One Key Recovery CD into the system and boot the system from the CD.

Step 4: When launching the recovery tool, press <F6>.

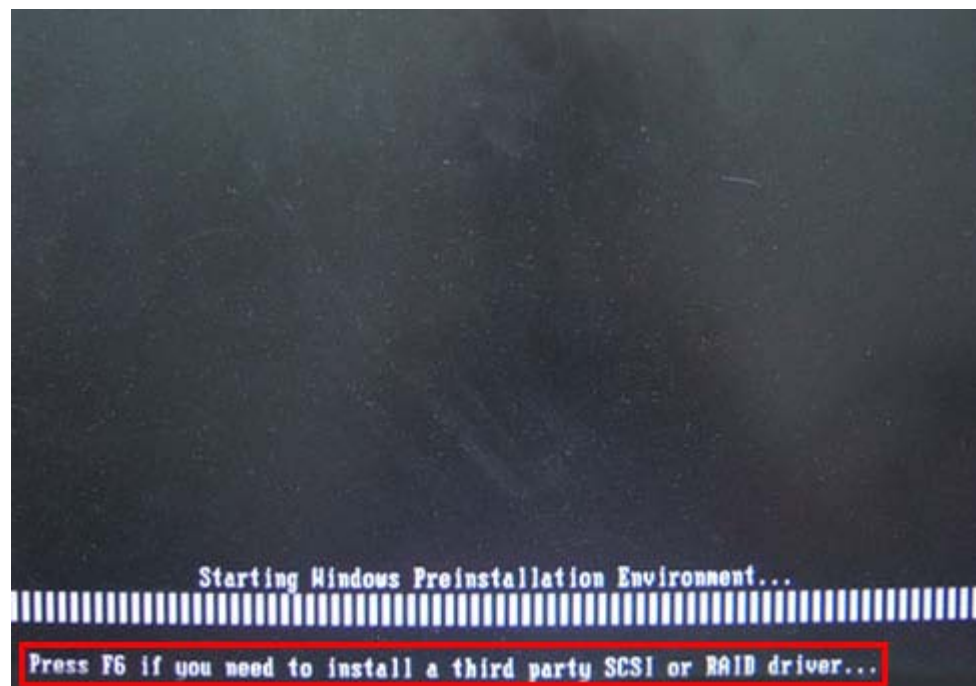

TANK-820-H61 Embedded System

Step 5: When the following window appears, press <S> to select “Specify Additional Device”.

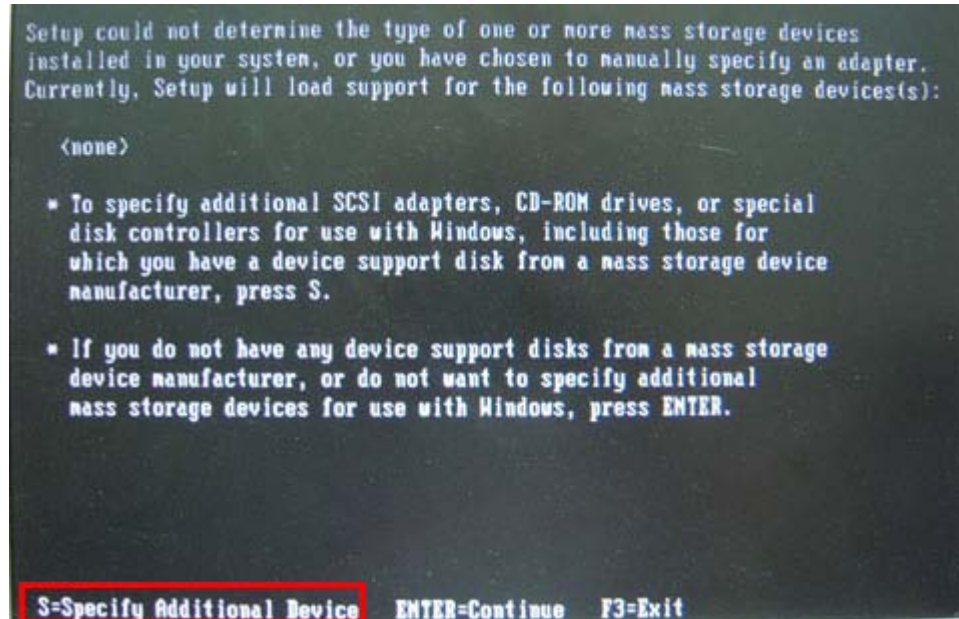

Step 6: In the following window, select a SATA controller mode used in the system. Then press <Enter>. The user can now start using the SATA HDD.

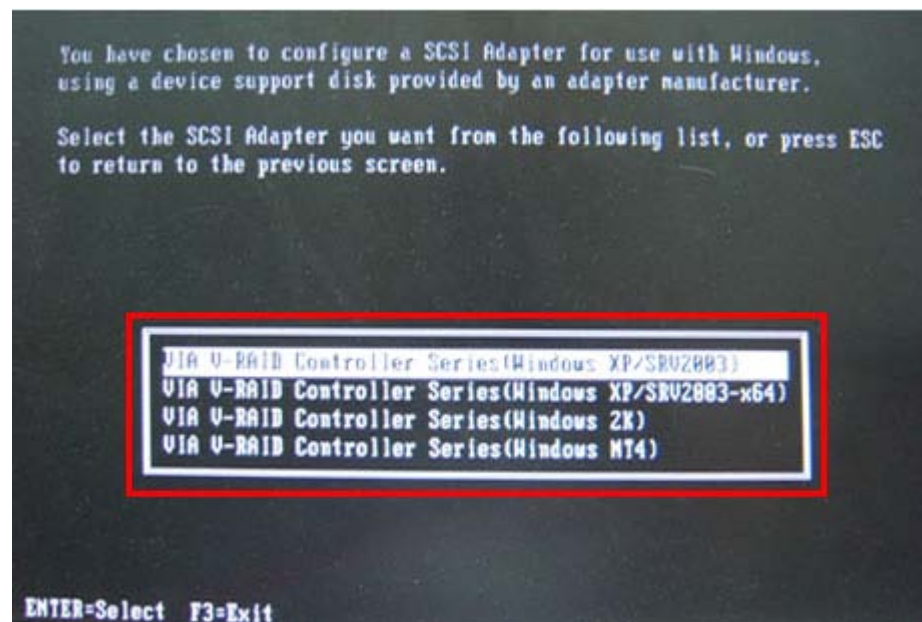

Step 7: After pressing <Enter>, the system will get into the recovery tool setup menu. Continue to follow the setup procedure from **Step 4** in **Section A.2.2 Create Partitions** to finish the whole setup process.

A.7.2 System Memory Requirement

To be able to access the recovery tool by pressing <F3> while booting up the system, please make sure to have enough system memory. The minimum memory requirement is listed below.

- **Using Award BIOS:** 128 MB system memory
- **Using AMI BIOS:** 512 MB system memory.

Appendix

B

Safety Precautions

B.1 Safety Precautions



WARNING:

The precautions outlined in this appendix should be strictly followed. Failure to follow these precautions may result in permanent damage to the TANK-820-H61.

Please follow the safety precautions outlined in the sections that follow:

B.1.1 General Safety Precautions

Please ensure the following safety precautions are adhered to at all times.

- ***Make sure the power is turned off and the power cord is disconnected*** when moving, installing or modifying the system.
- ***Do not apply voltage levels that exceed the specified voltage range.*** Doing so may cause fire and/or an electrical shock.
- ***Electric shocks can occur*** if opened while still powered on.
- ***Do not drop or insert any objects*** into the ventilation openings.
- ***If considerable amounts of dust, water, or fluids enter the system***, turn off the power supply immediately, unplug the power cord, and contact the system vendor.
- **DO NOT:**
 - Drop the system against a hard surface.
 - In a site where the ambient temperature exceeds the rated temperature

B.1.2 Anti-static Precautions



WARNING:

Failure to take ESD precautions during the installation of the TANK-820-H61 may result in permanent damage to the TANK-820-H61 and severe injury to the user.

TANK-820-H61 Embedded System

Electrostatic discharge (ESD) can cause serious damage to electronic components, including the TANK-820-H61. Dry climates are especially susceptible to ESD. It is therefore critical that whenever the TANK-820-H61 is opened and any of the electrical components are handled, the following anti-static precautions are strictly adhered to.

- **Wear an anti-static wristband:** Wearing a simple anti-static wristband can help to prevent ESD from damaging any electrical component.
- **Self-grounding:** Before handling any electrical component, touch any grounded conducting material. During the time the electrical component is handled, frequently touch any conducting materials that are connected to the ground.
- **Use an anti-static pad:** When configuring or working with an electrical component, place it on an anti-static pad. This reduces the possibility of ESD damage.
- **Only handle the edges of the electrical component:** When handling the electrical component, hold the electrical component by its edges.

B.1.3 Product Disposal



CAUTION:

Risk of explosion if battery is replaced by an incorrect type. Only certified engineers should replace the on-board battery.

Dispose of used batteries according to instructions and local regulations.

-
- Outside the European Union - If you wish to dispose of used electrical and electronic products outside the European Union, please contact your local authority so as to comply with the correct disposal method.
 - Within the European Union:

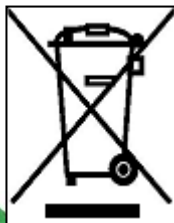

EU-wide legislation, as implemented in each Member State, requires that waste electrical and electronic products carrying the mark (left) must be disposed of separately from normal household waste. This includes

monitors and electrical accessories, such as signal cables or power cords. When you need to dispose of your display products, please follow the guidance of your local authority, or ask the shop where you purchased the product. The mark on electrical and electronic products only applies to the current European Union Member States.

Please follow the national guidelines for electrical and electronic product disposal.

B.2 Maintenance and Cleaning Precautions

When maintaining or cleaning the TANK-820-H61, please follow the guidelines below.

B.2.1 Maintenance and Cleaning

Prior to cleaning any part or component of the TANK-820-H61, please read the details below.

- The interior of the TANK-820-H61 does not require cleaning. Keep fluids away from the TANK-820-H61 interior.
- Be cautious of all small removable components when vacuuming the TANK-820-H61.
- Turn the TANK-820-H61 off before cleaning the TANK-820-H61.
- Never drop any objects or liquids through the openings of the TANK-820-H61.
- Be cautious of any possible allergic reactions to solvents or chemicals used when cleaning the TANK-820-H61.
- Avoid eating, drinking and smoking within vicinity of the TANK-820-H61.

B.2.2 Cleaning Tools

Some components in the TANK-820-H61 may only be cleaned using a product specifically designed for the purpose. In such case, the product will be explicitly mentioned in the cleaning tips. Below is a list of items to use when cleaning the TANK-820-H61.

- **Cloth** – Although paper towels or tissues can be used, a soft, clean piece of cloth is recommended when cleaning the TANK-820-H61.
- **Water or rubbing alcohol** – A cloth moistened with water or rubbing alcohol can be used to clean the TANK-820-H61.
- **Using solvents** – The use of solvents is not recommended when cleaning the TANK-820-H61 as they may damage the plastic parts.

TANK-820-H61 Embedded System

- **Vacuum cleaner** – Using a vacuum specifically designed for computers is one of the best methods of cleaning the TANK-820-H61. Dust and dirt can restrict the airflow in the TANK-820-H61 and cause its circuitry to corrode.
- **Cotton swabs** - Cotton swabs moistened with rubbing alcohol or water are excellent tools for wiping hard to reach areas.
- **Foam swabs** - Whenever possible, it is best to use lint free swabs such as foam swabs for cleaning.

Appendix

C

Hazardous Materials Disclosure

C.1 Hazardous Materials Disclosure Table for IPB Products Certified as RoHS Compliant Under 2002/95/EC Without Mercury

The details provided in this appendix are to ensure that the product is compliant with the Peoples Republic of China (China) RoHS standards. The table below acknowledges the presences of small quantities of certain materials in the product, and is applicable to China RoHS only.

A label will be placed on each product to indicate the estimated “Environmentally Friendly Use Period” (EFUP). This is an estimate of the number of years that these substances would “not leak out or undergo abrupt change.” This product may contain replaceable sub-assemblies/components which have a shorter EFUP such as batteries and lamps. These components will be separately marked.

Please refer to the table on the next page.

Part Name	Toxic or Hazardous Substances and Elements					
	Lead (Pb)	Mercury (Hg)	Cadmium (Cd)	Hexavalent Chromium (CR(VI))	Polybrominated Biphenyls (PBB)	Polybrominated Diphenyl Ethers (PBDE)
Housing	O	O	O	O	O	O
Display	O	O	O	O	O	O
Printed Circuit Board	O	O	O	O	O	O
Metal Fasteners	O	O	O	O	O	O
Cable Assembly	O	O	O	O	O	O
Fan Assembly	O	O	O	O	O	O
Power Supply Assemblies	O	O	O	O	O	O
Battery	O	O	O	O	O	O

O: This toxic or hazardous substance is contained in all of the homogeneous materials for the part is below the limit requirement in SJ/T11363-2006

X: This toxic or hazardous substance is contained in at least one of the homogeneous materials for this part is above the limit requirement in SJ/T11363-2006

TANK-820-H61 Embedded System

此附件旨在确保本产品符合中国 RoHS 标准。以下表格标示此产品中某有毒物质的含量符合中国 RoHS 标准规定的限量要求。

本产品上会附有“环境友好使用期限”的标签，此期限是估算这些物质“不会有泄漏或突变”的年限。本产品可能包含有较短的环境友好使用期限的可替换元件，像是电池或灯管，这些元件将会单独标示出来。

部件名称	有毒有害物质或元素					
	铅 (Pb)	汞 (Hg)	镉 (Cd)	六价铬 (CR(VI))	多溴联苯 (PBB)	多溴二苯 醚 (PBDE)
壳体	O	O	O	O	O	O
显示	O	O	O	O	O	O
印刷电路板	O	O	O	O	O	O
金属螺帽	O	O	O	O	O	O
电缆组装	O	O	O	O	O	O
风扇组装	O	O	O	O	O	O
电力供应组装	O	O	O	O	O	O
电池	O	O	O	O	O	O

O: 表示该有毒有害物质在该部件所有物质材料中的含量均在 SJ/T11363-2006 标准规定的限量要求以下。
X: 表示该有毒有害物质至少在该部件的某一均质材料中的含量超出 SJ/T11363-2006 标准规定的限量要求。