

MODEL:
PCISA-PV-D4251/N4551/D5251

**Half-Size CPU Card for Intel® Atom™ CPU,
DDR3, VGA, LAN, SATA 3Gb/s,
USB, HD Audio, RoHS Compliant**

User Manual

Revision

Date	Version	Changes
October 6, 2015	1.05	Updated memory specifications
July 1, 2013	1.04	Modified Table 3-20: COM2 Pinouts
December 3, 2012	1.03	Modified Table 3-18: Parallel Port Connector Pinouts Modified Section 2.4: Optional Items
July 25, 2011	1.02	Modified Table 3-17: LVDS LCD Connector Pinouts
December 7, 2010	1.01	Added model variations Updated specifications Added optional CPU fan installation instruction
September 10, 2010	1.00	Initial release

Copyright

COPYRIGHT NOTICE

The information in this document is subject to change without prior notice in order to improve reliability, design and function and does not represent a commitment on the part of the manufacturer.

In no event will the manufacturer be liable for direct, indirect, special, incidental, or consequential damages arising out of the use or inability to use the product or documentation, even if advised of the possibility of such damages.

This document contains proprietary information protected by copyright. All rights are reserved. No part of this manual may be reproduced by any mechanical, electronic, or other means in any form without prior written permission of the manufacturer.

TRADEMARKS

All registered trademarks and product names mentioned herein are used for identification purposes only and may be trademarks and/or registered trademarks of their respective owners.

Manual Conventions



WARNING

Warnings appear where overlooked details may cause damage to the equipment or result in personal injury. Warnings should be taken seriously.



CAUTION

Cautionary messages should be heeded to help reduce the chance of losing data or damaging the product.



NOTE

These messages inform the reader of essential but non-critical information. These messages should be read carefully as any directions or instructions contained therein can help avoid making mistakes.



HOT SURFACE

This symbol indicates a hot surface that should not be touched without taking care.

Table of Contents

1 INTRODUCTION.....	1
1.1 INTRODUCTION.....	2
1.2 MODEL VARIATIONS	2
1.3 BENEFITS	3
1.4 FEATURES.....	3
1.5 CONNECTORS	4
1.6 DIMENSIONS.....	6
1.7 DATA FLOW	7
1.8 TECHNICAL SPECIFICATIONS	8
2 PACKING LIST.....	10
2.1 ANTI-STATIC PRECAUTIONS	11
2.2 UNPACKING PRECAUTIONS.....	11
2.3 PACKING LIST.....	12
2.4 OPTIONAL ITEMS	13
3 CONNECTORS	15
3.1 PERIPHERAL INTERFACE CONNECTORS.....	16
3.1.1 <i>Layout</i>	16
3.1.2 <i>Peripheral Interface Connectors</i>	16
3.1.3 <i>External Interface Panel Connectors</i>	18
3.2 INTERNAL PERIPHERAL CONNECTORS	18
3.2.1 <i>ATX Power Supply Enable Connector</i>	18
3.2.2 <i>Audio Connector</i>	19
3.2.3 <i>Battery Connector</i>	20
3.2.4 <i>CompactFlash® Socket</i>	21
3.2.5 <i>Digital Input/Output Connector</i>	22
3.2.6 <i>Fan Connector</i>	23
3.2.7 <i>Floppy Disk Connector (34-pin)</i>	24
3.2.8 <i>Flash SPI ROM Connector</i>	25
3.2.9 <i>Front Panel Connector</i>	26

3.2.10 IDE Connector	27
3.2.11 Infrared Interface Connector	28
3.2.12 Keyboard/Mouse Connector	29
3.2.13 LCD Backlight Connector.....	30
3.2.14 LVDS LCD connector	31
3.2.15 Parallel Port Connector	32
3.2.16 RS-232 Serial Port Connectors (COM1, COM3 and COM4)	33
3.2.17 RS-232/422/485 Serial Port Connector (COM2)	34
3.2.18 SATA Drive Connectors	34
3.2.19 SMBus Connector	35
3.2.20 USB Connectors (Internal)	36
3.3 EXTERNAL PERIPHERAL INTERFACE CONNECTOR PANEL	37
3.3.1 CRT Connector	38
3.3.2 Ethernet Connectors	38
3.3.3 USB Connector	40
4 INSTALLATION	41
4.1 ANTI-STATIC PRECAUTIONS	42
4.2 INSTALLATION CONSIDERATIONS.....	42
4.3 BASIC INSTALLATION	44
4.3.1 SO-DIMM Installation	44
4.3.2 Airflow.....	44
4.3.3 Backplane Installation	45
4.3.4 CPU Card Installation.....	45
4.3.5 Optional CPU Fan Installation	45
4.4 JUMPER SETTINGS	46
4.4.1 CF Card Setup	47
4.4.2 Clear CMOS Jumper.....	48
4.4.3 COM 2 Function Select Jumper.....	49
4.4.4 LVDS Voltage Selection.....	50
4.4.5 LVDS Panel Resolution Selection	51
4.4.6 PCIe Interface Setup.....	52
4.5 INTERNAL PERIPHERAL DEVICE CONNECTIONS.....	53
4.5.1 SATA Drive Connection	53
4.5.2 USB Cable (Dual Port) with Slot Bracket	55

PCISA-PV-D4251/N4551/D5251 CPU Card

4.6 SOFTWARE INSTALLATION	56
5 BIOS	57
5.1 INTRODUCTION.....	58
5.1.1 Starting Setup.....	58
5.1.2 Using Setup	58
5.1.3 Getting Help.....	59
5.1.4 Unable to Reboot After Configuration Changes.....	59
5.1.5 BIOS Menu Bar.....	59
5.2 MAIN.....	60
5.3 ADVANCED	61
5.3.1 Trusted Computing	61
5.3.2 CPU Configuration.....	62
5.3.3 SATA Configuration	64
5.3.4 USB Configuration.....	65
5.3.5 Super IO Configuration	66
5.3.5.1 Floppy Disk Controller Configuration.....	67
5.3.5.2 Serial Port n Configuration	68
5.3.5.3 IrDA Configuration.....	71
5.3.5.4 Parallel Port Configuration	72
5.3.6 H/W Monitor	73
5.3.7 Serial Port Console Redirection	75
5.4 CHIPSET	76
5.4.1 Host Bridge Configuration	77
5.4.1.1 OnChip VGA Configuration.....	78
5.4.2 South Bridge Configuration.....	79
5.4.3 Intel IGD SWSCI OpRegion.....	80
5.5 BOOT.....	82
5.6 SECURITY.....	84
5.7 EXIT	85
A REGULATORY COMPLIANCE	87
B BIOS OPTIONS	89
C TERMINOLOGY	92
D WATCHDOG TIMER	96

E DIGITAL I/O INTERFACE	99
E.1 INTRODUCTION	100
E.2 DIO CONNECTOR PINOUTS	100
E.3 ASSEMBLY LANGUAGE EXAMPLE	100
F HAZARDOUS MATERIALS DISCLOSURE.....	101
F.1 HAZARDOUS MATERIALS DISCLOSURE TABLE FOR IPB PRODUCTS CERTIFIED AS ROHS COMPLIANT UNDER 2002/95/EC WITHOUT MERCURY	102

List of Figures

Figure 1-1: PCISA-PV-D4251/N4551/D5251	2
Figure 1-2: Connectors (Front Side).....	4
Figure 1-3: Connectors (Solder Side).....	5
Figure 1-4: Dimensions (mm).....	6
Figure 1-5: Data Flow Diagram.....	7
Figure 3-1: Connectors and Jumpers.....	16
Figure 3-2: ATX Power Supply Enable Connector Location	18
Figure 3-3: Audio Connector Location	19
Figure 3-4: Battery Connector Location.....	20
Figure 3-5: CF Card Socket Location	21
Figure 3-6: DIO Connector Location.....	22
Figure 3-7: Fan Connector Locations.....	23
Figure 3-8: 34-pin FDD Connector Location	24
Figure 3-9: Flash SPI ROM Connector Locations	25
Figure 3-10: Front Panel Connector Location	26
Figure 3-11: IDE Device Connector Location	27
Figure 3-12: Infrared Connector Pinout Locations	29
Figure 3-13: Keyboard/Mouse Connector Location	29
Figure 3-14: LCD Backlight Connector Location	30
Figure 3-15: LVDS LCD Connector Location	31
Figure 3-16: Parallel Port Connector Location	32
Figure 3-17: RS-232 Connector Pinout Locations.....	33
Figure 3-18: COM2 Location.....	34
Figure 3-19: SATA Drive Connector Locations	35
Figure 3-20: SMBus Connector Location	36
Figure 3-21: Internal USB Connector Locations	37
Figure 3-22: External Peripheral Interface Connector	37
Figure 3-23: VGA Connector	38
Figure 3-24: RJ-45 Ethernet Connector.....	39
Figure 4-1: SO-DIMM Installation	44

Figure 4-2: Connect Fan Cable.....	46
Figure 4-3: CF Card Setup Jumper Location	48
Figure 4-4: Clear CMOS Jumper	49
Figure 4-5: COM 2 Function Select Jumper Location.....	50
Figure 4-6: LVDS Voltage Selection Jumper Pinout Locations	51
Figure 4-7: LVDS Resolution Selection Jumper Pinout Locations	52
Figure 4-8: PCIe Slot Jumper Location	53
Figure 4-9: SATA Drive Cable Connection.....	54
Figure 4-10: SATA Power Drive Connection.....	54
Figure 4-11: Dual USB Cable Connection	55

List of Tables

Table 1-1: Model Variations	3
Table 1-2: Technical Specifications.....	9
Table 2-1: Packing List.....	13
Table 2-2: Optional Items	14
Table 3-1: Internal Peripheral Connectors	17
Table 3-2: External Peripheral Connectors	18
Table 3-3: ATX Power Supply Enable Connector Pinouts	19
Table 3-4: AT/ATX Power Mode Setting	19
Table 3-5: Audio Connector Pinouts	20
Table 3-6: Battery Connector Pinouts	20
Table 3-7: CF Card Socket Pinouts.....	22
Table 3-8: DIO Connector Pinouts	23
Table 3-9: Fan Connector Pinouts	24
Table 3-10: 34-pin FDD Connector Pinouts	25
Table 3-11: Flash SPI ROM Connector Pinouts.....	26
Table 3-12: Front Panel Connector Pinouts.....	27
Table 3-13: IDE Connector Pinouts.....	28
Table 3-14: Infrared Connector Pinouts	29
Table 3-15: Keyboard/Mouse Connector Pinouts	30
Table 3-16: LCD Backlight Connector Pinouts.....	31
Table 3-17: LVDS LCD Connector Pinouts	31
Table 3-18: Parallel Port Connector Pinouts	32
Table 3-19: RS-232 Connector Pinouts	33
Table 3-20: COM2 Pinouts	34
Table 3-21: SATA Drive Connector Pinouts.....	35
Table 3-22: SMBus Connector Pinouts	36
Table 3-23: USB3 and USB4 Pinouts.....	37
Table 3-24: VGA Connector Pinouts.....	38
Table 3-25: LAN1 and LAN2 Pinouts	39
Table 3-26: RJ-45 Ethernet Connector LEDs	39

Table 3-27: External USB Connector Pinouts.....	40
Table 4-1: Jumpers	47
Table 4-2: CF Card Setup Jumper Settings	47
Table 4-3: Clear CMOS Jumper Settings.....	48
Table 4-4: COM 2 Function Select Jumper Settings	49
Table 4-5: LVDS Voltage Selection Jumper Settings.....	51
Table 4-6: LVDS Resolution Selection Jumper Settings	52
Table 4-7: PCIe Slot Jumper Setting.....	52
Table 5-1: BIOS Navigation Keys	59

BIOS Menus

BIOS Menu 1: Main	60
BIOS Menu 2: Advanced	61
BIOS Menu 3: TPM Configuration	62
BIOS Menu 4: CPU Configuration	63
BIOS Menu 5: IDE Configuration	64
BIOS Menu 6: USB Configuration	65
BIOS Menu 7: Super IO Configuration.....	66
BIOS Menu 8: Floppy Disk Controller Configuration Menu	67
BIOS Menu 9: Serial Port n Configuration Menu	68
BIOS Menu 10: IrDA Configuration Menu.....	71
BIOS Menu 11: Parallel Port Configuration Menu	72
BIOS Menu 12: Hardware Health Configuration	74
BIOS Menu 13: Serial Port Console Redirection	75
BIOS Menu 14: Chipset	76
BIOS Menu 15: Host Bridge Chipset Configuration.....	77
BIOS Menu 16: OnChip VGA Configuration.....	78
BIOS Menu 17:South Bridge Chipset Configuration.....	79
BIOS Menu 18:South Bridge Chipset Configuration.....	80
BIOS Menu 19: Boot	82
BIOS Menu 20: Security	84
BIOS Menu 21:Exit.....	85

Chapter

1

Introduction

1.1 Introduction

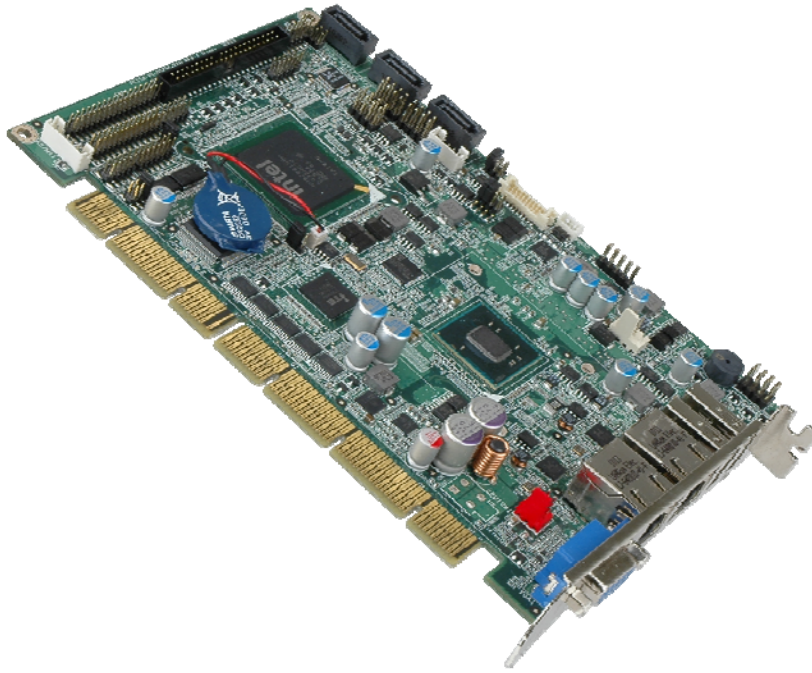

Figure 1-1: PCISA-PV-D4251/N4551/D5251

The PCISA-PV-D4251/N4551/D5251 half-size PCISA CPU card is an Intel® Atom™ dual-core CPU platform. The PCISA-PV-D4251/N4551/D5251 comes with a DDR3 SO-DIMM socket, VGA interface and dual PCI Express (PCIe) Gigabit Ethernet (GbE). The PCISA-PV-D4251/N4551/D5251 supports up to three, second-generation serial ATA (SATA) hard disk drives (HDD) with maximum transfer rates of 3Gb/s and up to six USB 2.0 devices. The PCISA-PV-D4251/N4551/D5251 also has a CompactFlash® card socket for additional system storage. Multiple display support adds versatility to the system enabling system integrators and designers increased flexibility in selecting display panel options.

1.2 Model Variations

The PCISA-PV series has six models. The model variations are list below.

Model Name	CPU	CPU Core	TPM
PCISA-PV-D5251	Intel® Atom™ D525	Dual core	No
PCISA-PV-D5251T	Intel® Atom™ D525	Dual core	Yes

PCISA-PV-D4251/N4551/D5251 CPU Card

PCISA-PV-D4251	Intel® Atom™ D425	Single core	No
PCISA-PV-D4251T	Intel® Atom™ D425	Single core	Yes
PCISA-PV-N4551	Intel® Atom™ N455	Single core	No
PCISA-PV-N4551T	Intel® Atom™ N455	Single core	Yes

Table 1-1: Model Variations

1.3 Benefits

Some of the PCISA-PV-D4251/N4551/D5251 motherboard benefits include:

- Powerful graphics
- Staying connected with both wired LAN connections
- Speedy running of multiple programs and applications

1.4 Features

Some of the PCISA-PV-D4251/N4551/D5251 motherboard features are listed below:

- RoHS compliant
- Supports Intel® Atom™ dual-core/single-core processor
- Supports one 204-pin 800 MHz DDR3 SDRAM SO-DIMM
- Dual PCIe GbE connectors
- Supports three SATA drives with transfer rates up to 3Gb/s
- Supports six USB 2.0 devices
- Supports four serial ports
- Support 18-bit LVDS and VGA for dual display

1.5 Connectors

The connectors on the PCISA-PV-D4251/N4551/D5251 are shown in the figure below.

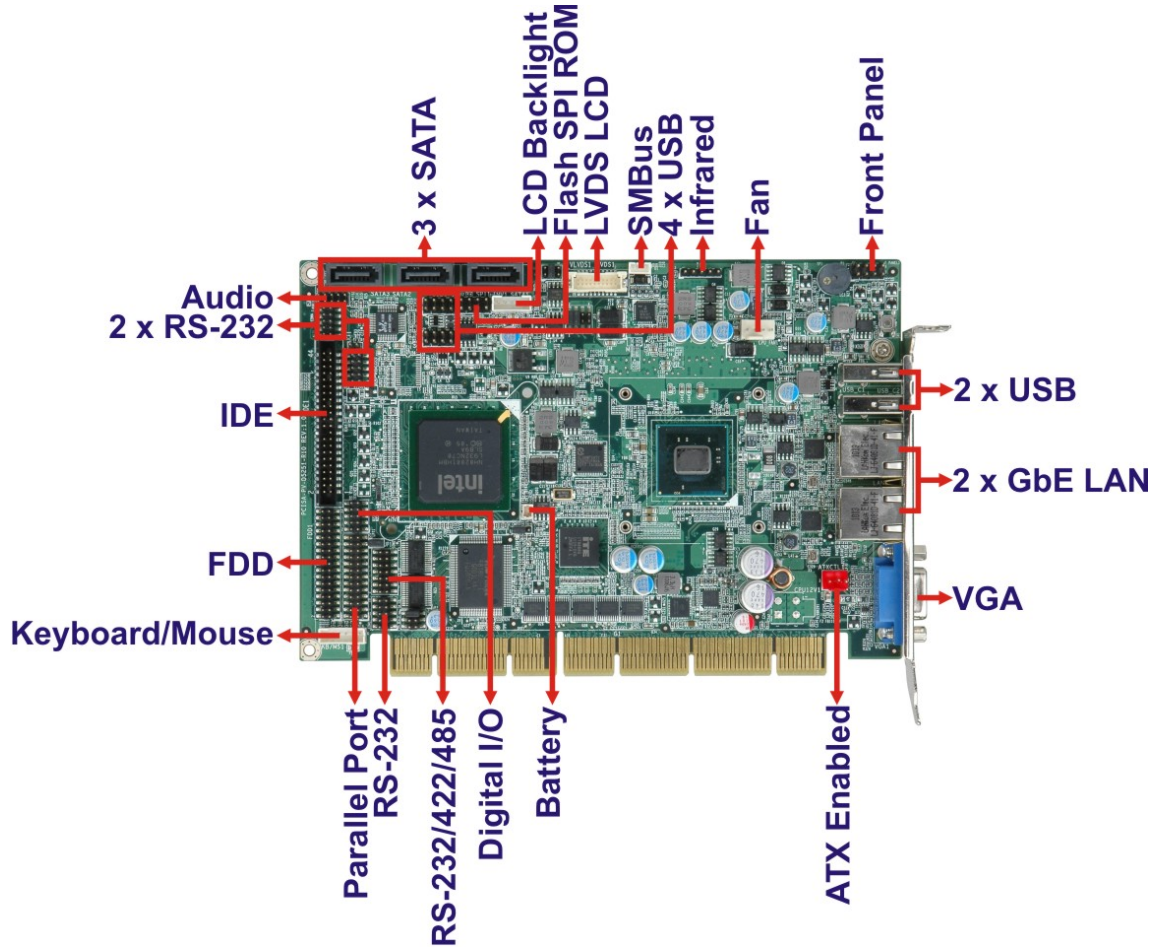

Figure 1-2: Connectors (Front Side)

PCISA-PV-D4251/N4551/D5251 CPU Card

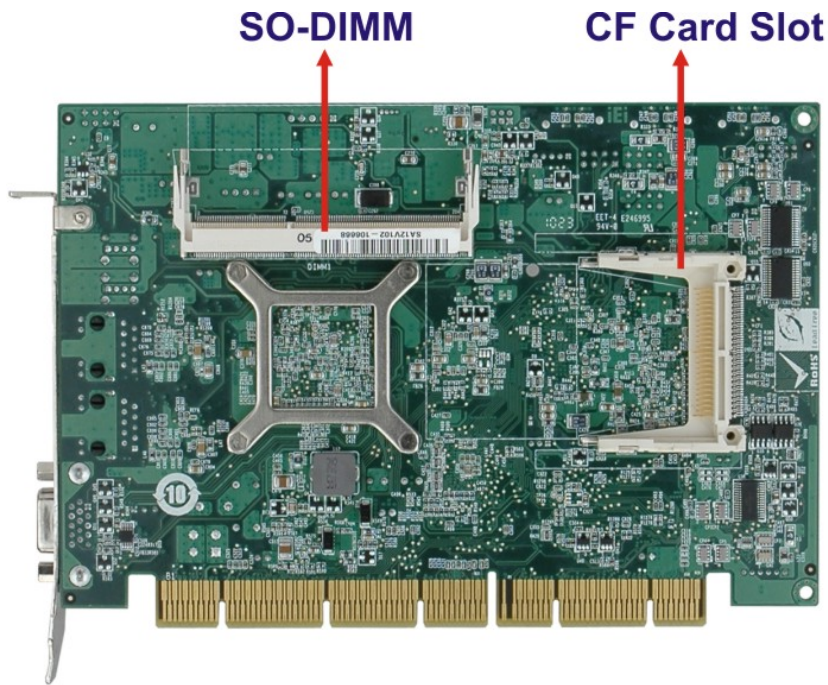

Figure 1-3: Connectors (Solder Side)

1.6 Dimensions

The main dimensions of the PCISA-PV-D4251/N4551/D5251 are shown in the diagram below.

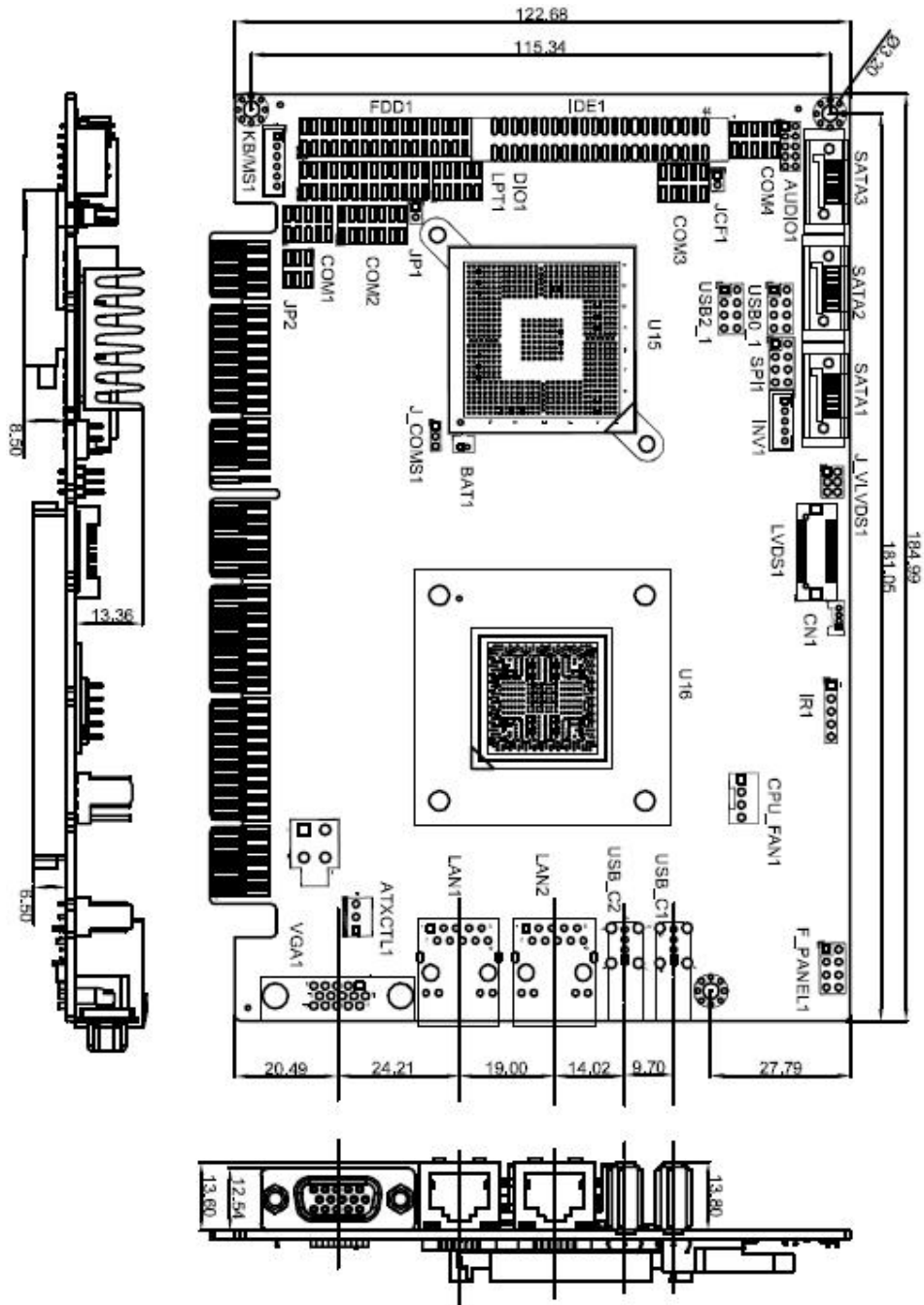

Figure 1-4: Dimensions (mm)

PCISA-PV-D4251/N4551/D5251 CPU Card

1.7 Data Flow

Figure 1-5 shows the data flow between the system chipset, the CPU and other components installed on the motherboard.

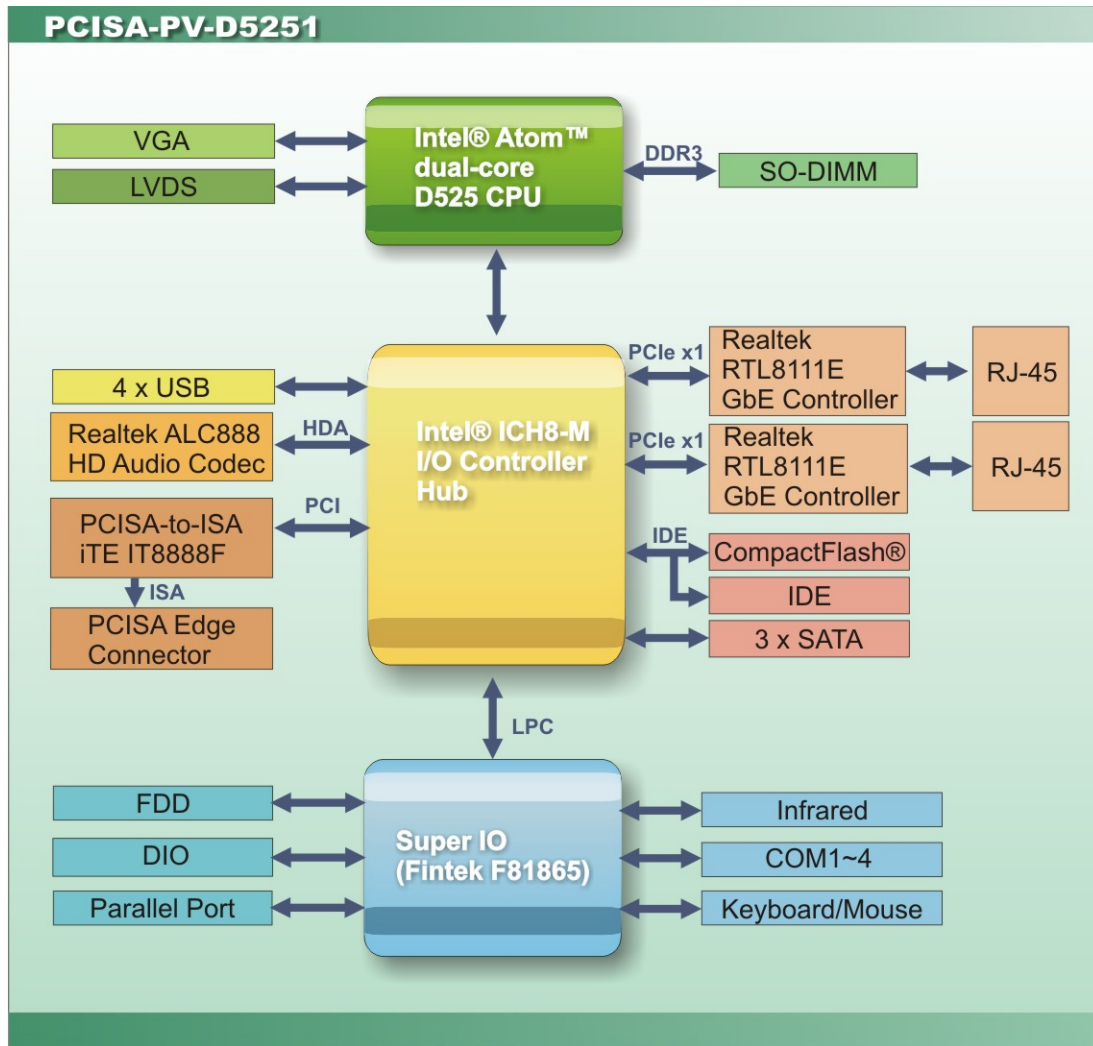

Figure 1-5: Data Flow Diagram

1.8 Technical Specifications

PCISA-PV-D4251/N4551/D5251 technical specifications are shown below.

Specifications	PCISA-PV-D4251/N4551/D5251
CPU Supported	Intel® Atom™ D525 dual core processor (1.80GHz/1MB L2 cache) Intel® Atom™ D425 single core processor (1.80GHz/512KB L2 cache) Intel® Atom™ N455 single core processor (1.66GHz/512KB L2 cache)
Chipset	Intel® ICH8M
Memory	One 204-pin 800 MHz DDR3 SDRAM SO-DIMM (system max. 4 GB for D525/D425 and 2 GB for N455)
Graphic Engine	Intel® GMA3150 <ul style="list-style-type: none"> ▪ D525/D425: Gen 3.5 DX9, 400 MHz ▪ N455: Gen 3.5 DX9, 200 MHz
Integrated Graphics	Analog CRT (CRT hot plug supported) <ul style="list-style-type: none"> ▪ D525/D425: up to 2048 x 1536 ▪ N455: up to 1400 x 1050 18-bit single-channel LVDS supports up to WXGA 1366x768 or XGA 1024x768 resolution
BIOS	UEFI BIOS
Digital I/O	8-bit, 4-bit input/4-bit output
Ethernet Controllers	Two Realtek RTL8111E PCIe GbE controllers (LAN1 supports ASF2.0)
Super I/O Controller	Fintek F81865
Watchdog Timer	Software programmable supports 1~255 sec. system reset
Audio	Realtek ALC888 HD Audio codec
Expansion	4 x PCI bus ISA bus supported by ITE IT8888G PCI-to-ISA bridge
TPM (Optional)	On-board Infineon trusted platform module (TPM) SLB9635 TT1.2
I/O Interface	
CompactFlash®	One CompactFlahs® Type II slot

PCISA-PV-D4251/N4551/D5251 CPU Card

Fan connector	One 4-pin wafer for CPU fan
Keyboard/Mouse	One internal 6-pin wafer connector
Serial Ports	Three RS-232 COM connectors One RS-232/422/485 COM connector
USB 2.0/1.1 ports	Four internal via pin header Two external USB ports
Infrared	One infrared connector
Parallel Port	One parallel port via 26-pin header
Serial ATA	Three independent SATA channels with 3.0 Gb/s data transfer rates
Floppy Disk Drive	One FDD connector via 34-pin header
IDE	One IDE connector via 44-pin box header
Environmental and Power Specifications	
Power Supply	AT/ATX supported; 5 V or 12 V by PCISA bus
Power Consumption	12 V @ 0.57 A 5 V @ 3.36 A (1.8 GHz Intel® Atom™ D525 dual-core CPU with one 1 GB 1066 MHz DDR3 SO-DIMM) 12 V @ 0.42 A 5 V @ 1.52 A (1.66GHz Intel Atom™ N455 single-core CPU with one 1 GB 1066 MHz DDR3 running 3Dmark®2001)
Operating temperature	D525: -20°C ~ 60°C with free air; -20°C ~ 70°C with force air D425: -20°C ~ 65°C with free air; -20°C ~ 70°C with force air N455: -20°C ~ 70°C with free air; -20°C ~ 75°C with force air
Humidity	5% ~ 95% (non-condensing)
Physical Specifications	
Dimensions	185 mm x 127.6 mm
Weight (Gross/Net)	1000 g / 250 g

Table 1-2: Technical Specifications

Chapter

2

Packing List

2.1 Anti-static Precautions



WARNING!

Static electricity can destroy certain electronics. Make sure to follow the ESD precautions to prevent damage to the product, and injury to the user.

Make sure to adhere to the following guidelines:

- **Wear an anti-static wristband:** Wearing an anti-static wristband can prevent electrostatic discharge.
- **Self-grounding:** Touch a grounded conductor every few minutes to discharge any excess static buildup.
- **Use an anti-static pad:** When configuring any circuit board, place it on an anti-static mat.
- **Only handle the edges of the PCB:** Don't touch the surface of the motherboard. Hold the motherboard by the edges when handling.

2.2 Unpacking Precautions

When the PCISA-PV-D4251/N4551/D5251 is unpacked, please do the following:

- Follow the antistatic guidelines above.
- Make sure the packing box is facing upwards when opening.
- Make sure all the packing list items are present.





2.3 Packing List



NOTE:

If any of the components listed in the checklist below are missing, do not proceed with the installation. Contact the IEI reseller or vendor the PCISA-PV-D4251/N4551/D5251 was purchased from or contact an IEI sales representative directly by sending an email to sales@ieiworld.com.

The PCISA-PV-D4251/N4551/D5251 is shipped with the following components:

Quantity	Item and Part Number	Image
1	PCISA-PV-D4251, PCISA-PV-N4551, PCISA-PV-D5251, PCISA-PV-D4251T, PCISA-PV-N4551T or PCISA-PV-D5251T	
3	SATA cable (P/N: 32000-062800-RS)	
1	LPT/RS-232 cable (P/N: 19800-002300-200-RS)	
1	USB cable (P/N: 19800-003100-300-RS)	
1	Audio cable (P/N: 19800-000111-RS)	

PCISA-PV-D4251/N4551/D5251 CPU Card







Quantity	Item and Part Number	Image
1	Mini jumper pack (2.0mm) (P/N:33100-000033-RS)	
1	Utility CD	
1	One Key Recovery CD	
1	Quick Installation Guide	

Table 2-1: Packing List

2.4 Optional Items

The following are optional components which may be separately purchased:

Item and Part Number	Image
CPU fan (P/N: 19FFD124010HB2A7-000001-RS)	
FDD cable (P/N: 32229-000400-100-RS)	
KB/MS cable (P/N: 19800-000075-RS)	



Item and Part Number	Image
IDE flat cable (P/N: 32200-000009-RS)	 A white IDE flat cable with a black plastic housing at one end.
SATA power cable (P/N: 32102-000100-200-RS)	 A black SATA power cable with a SATA power connector at one end and a SATA data connector at the other.

Table 2-2: Optional Items

Chapter

3

Connectors

3.1 Peripheral Interface Connectors

This chapter details all the jumpers and connectors.

3.1.1 Layout

The figure below shows all the connectors and jumpers.

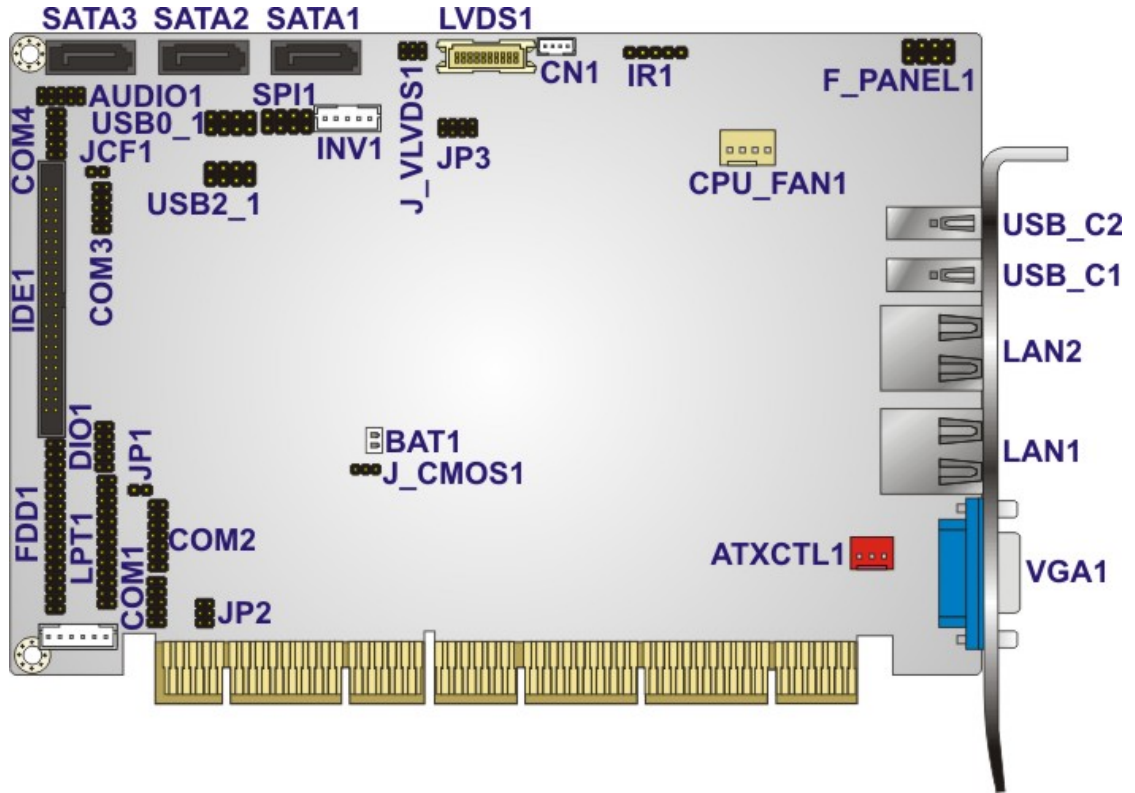

Figure 3-1: Connectors and Jumpers

3.1.2 Peripheral Interface Connectors

The table below lists all the connectors on the board.

Connector	Type	Label
ATX enable connector	3-pin wafer	ATXCTL1
Audio connector	10-pin header	AUDIO1
Battery connector	2-pin wafer	BAT1

PCISA-PV-D4251/N4551/D5251 CPU Card

Connector	Type	Label
CompactFlash® card slot	50-pin slot (solder side)	CF1
DDR3 DIMM socket	204-pin slot (solder side)	DIMM1
Digital input/output connector	10-pin header	DIO1
Fan connector, CPU	4-pin wafer connector	CPU_FAN1
FDD connector	34-pin header	FDD1
Flash SPI ROM connector	8-pin header	SPI1
Front panel connector	8-pin header	F_PANEL1
IDE Interface connector	44-pin box header	IDE1
Infrared interface connector	5-pin header	IR1
Keyboard/Mouse connector	6-pin wafer	KB/MS1
LCD backlight connector	5-pin wafer connector	INV1
LVDS LCD connector	20-pin crimp connector	LVDS1
Parallel port connector	26-pin header	LPT1
RS-232 serial port connector	10-pin header	COM1
RS-232/422/485 serial port connector	14-pin header	COM2
RS-232 serial port connector	10-pin header	COM3
RS-232 serial port connector	10-pin header	COM4
SATA drive connector (1)	7-pin SATA connector	SATA1
SATA drive connector (2)	7-pin SATA connector	SATA2
SATA drive connector (3)	7-pin SATA connector	SATA3
SMBus connector	4-pin wafer connector	CN1
USB connector (1)	8-pin header	USB0_1
USB connector (2)	8-pin header	USB2_1

Table 3–1: Internal Peripheral Connectors

3.1.3 External Interface Panel Connectors

The table below lists the connectors on the external I/O panel.

Connector	Type	Label
CRT connector	15-pin female connector	VGA1
Ethernet connector (1)	RJ-45 connector	LAN1
Ethernet connector (2)	RJ-45 connector	LAN2
USB 2.0 port (1)	USB port connector	USB_C1
USB 2.0 port (2)	USB port connector	USB_C2

Table 3–2: External Peripheral Connectors

3.2 Internal Peripheral Connectors

The section describes all of the connectors on the PCISA-PV-D4251/N4551/D5251.

3.2.1 ATX Power Supply Enable Connector

- CN Label:** ATXCTL1
- CN Type:** 3-pin wafer (1x3)
- CN Location:** See **Figure 3-2**
- CN Pinouts:** See **Table 3-3**

The ATX power supply enable connector enables the PCISA-PV-D4251/N4551/D5251 to be connected to an ATX power supply.

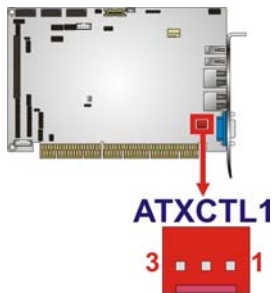

Figure 3-2: ATX Power Supply Enable Connector Location

PCISA-PV-D4251/N4551/D5251 CPU Card

PIN NO.	DESCRIPTION
1	+5V Standby
2	PS-ON
3	GND

Table 3-3: ATX Power Supply Enable Connector Pinouts

The AT/ATX power mode settings are listed below.

PIN NO.	DESCRIPTION
AT Mode	Short 2-3
ATX Mode	Use PS_ON# and 5VSB cable

Table 3-4: AT/ATX Power Mode Setting

3.2.2 Audio Connector

- CN Label:** AUDIO1
- CN Type:** 10-pin header (2x5)
- CN Location:** See **Figure 3-3**
- CN Pinouts:** See **Table 3-5**

The audio connector connects to the optional audio cable.

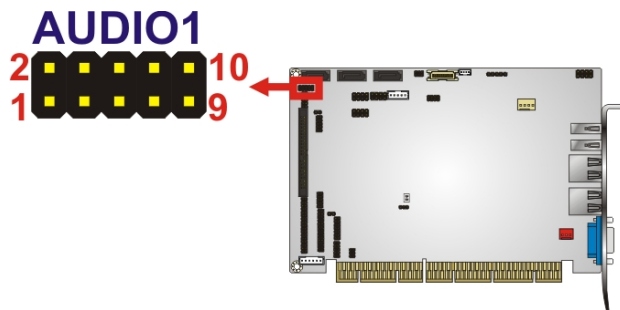

Figure 3-3: Audio Connector Location

PIN NO.	DESCRIPTION	PIN NO.	DESCRIPTION
1	SPK_R	2	LINE1R
3	GND	4	GND
5	SPK_L	6	LINE1L
7	GND	8	GND
9	FMIC1R	10	FMIC1L

Table 3-5: Audio Connector Pinouts

3.2.3 Battery Connector

- CN Label:** **BAT1**
- CN Type:** 2-pin wafer (1x2)
- CN Location:** See **Figure 3-4**
- CN Pinouts:** See **Table 3-6**

This is connected to the system battery. The battery provides power to the system clock to retain the time when power is turned off.

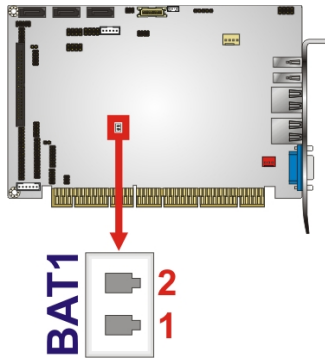

Figure 3-4: Battery Connector Location

Pin	Description
1	Battery+ (+3V)
2	Ground

Table 3-6: Battery Connector Pinouts

PCISA-PV-D4251/N4551/D5251 CPU Card

3.2.4 CompactFlash® Socket

CN Label: CF1 (solder side)

CN Type: 50-pin slot (2x25)

CN Location: See **Figure 3-5**

CN Pinouts: See **Table 3-7**

A CF Type I or Type II memory card is inserted to the CF socket on the solder side of the PCISA-PV-D4251/N4551/D5251.

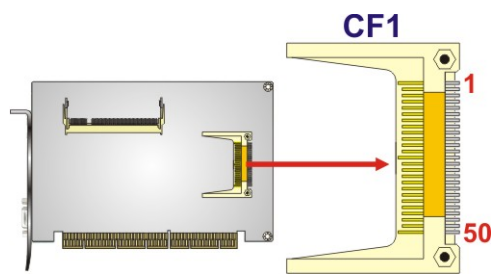

Figure 3-5: CF Card Socket Location

PIN NO.	DESCRIPTION	PIN NO.	DESCRIPTION
1	GROUND	26	VCC-IN CHECK1
2	DATA 3	27	DATA 11
3	DATA 4	28	DATA 12
4	DATA 5	29	DATA 13
5	DATA 6	30	DATA 14
6	DATA 7	31	DATA 15
7	HDC_CS0#	32	HDC_CS1
8	N/C	33	N/C
9	GROUND	34	IOR#
10	N/C	35	IOW#
11	N/C	36	VCC_COM
12	N/C	37	IRQ15
13	VCC_COM	38	VCC_COM
14	N/C	39	CSEL
15	N/C	40	N/C

16	N/C	41	HDD_RESET
17	N/C	42	IORDY
18	SA2	43	SDREQ
19	SA1	44	SDACK#
20	SA0	45	HDD_ACTIVE#
21	DATA 0	46	66DET
22	DATA 1	47	DATA 8
23	DATA 2	48	DATA 9
24	N/C	49	DATA 10
25	VCC-IN CHECK2	50	GROUND

Table 3-7: CF Card Socket Pinouts

3.2.5 Digital Input/Output Connector

- CN Label:** DIO1
- CN Type:** 10-pin header (2x5)
- CN Location:** See **Figure 3-6**
- CN Pinouts:** See **Table 3-8**

The DIO connector is managed through a Super I/O chip. The DIO connector pins are user programmable. The digital IO port of PCISA-PV-D4251/N4551/D5251 is 5V CMOS level.

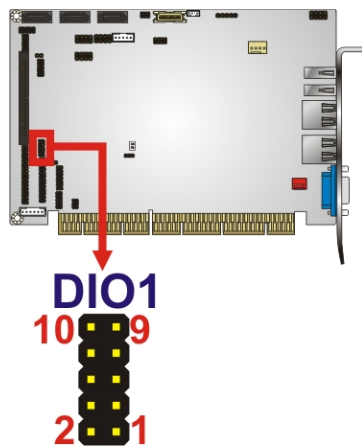

Figure 3-6: DIO Connector Location

PCISA-PV-D4251/N4551/D5251 CPU Card

PIN NO.	DESCRIPTION	PIN NO.	DESCRIPTION
1	GND	2	+5 V
3	OUTPUT 3	4	OUTPUT 2
5	OUTPUT 1	6	OUTPUT 0
7	INPUT 3	8	INPUT 2
9	INPUT 1	10	INPUT 0

Table 3-8: DIO Connector Pinouts

3.2.6 Fan Connector

- CN Label:** CPU_FAN1
- CN Type:** 4-pin wafer connector (1x4)
- CN Location:** See **Figure 3-7**
- CN Pinouts:** See **Table 3-9**

The cooling fan connector provides a 12V, 500mA current to a CPU cooling fan. The connector has a "rotation" pin to get rotation signals from fans and notify the system so the system BIOS can recognize the fan speed. Please note that only specified fans can issue the rotation signals.

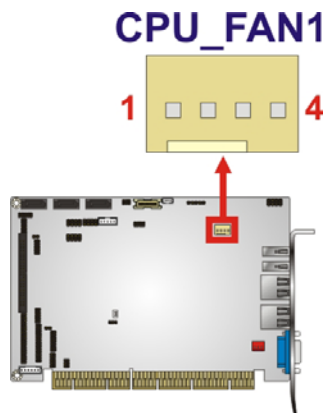

Figure 3-7: Fan Connector Locations

PIN NO.	DESCRIPTION
1	GND
2	+12V
3	Sense
4	Control

Table 3-9: Fan Connector Pinouts

3.2.7 Floppy Disk Connector (34-pin)

- CN Label:** FDD1
- CN Type:** 34-pin header (2x17)
- CN Location:** See **Figure 3-8**
- CN Pinouts:** See **Table 3-10**

The floppy disk connector is connected to a floppy disk drive.

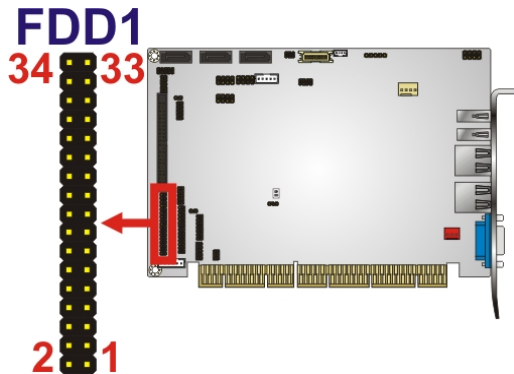

Figure 3-8: 34-pin FDD Connector Location

PIN NO.	DESCRIPTION	PIN NO.	DESCRIPTION
1	GND	2	REDUCE WRITE
3	GND	4	N/C
5	N/C	6	N/C
7	GND	8	INDEX#
9	GND	10	MOTOR ENABLE A#
11	GND	12	DRIVE SELECT B#
13	GND	14	DRIVE SELECT A#

PCISA-PV-D4251/N4551/D5251 CPU Card

15	GND	16	MOTOR ENABLE B#
17	GND	18	DIRECTION#
19	GND	20	STEP#
21	GND	22	WRITE DATA#
23	GND	24	WRITE GATE#
25	GND	26	TRACK 0#
27	GND	28	WRITE PROTECT#
29	GND	30	READ DATA#
31	GND	32	SIDE 1 SELECT#
33	GND	34	DISK CHANGE#

Table 3-10: 34-pin FDD Connector Pinouts

3.2.8 Flash SPI ROM Connector

- CN Label:** SPI1
- CN Type:** 8-pin header (2x4)
- CN Location:** See **Figure 3-9**
- CN Pinouts:** See **Table 3-11**

Use the Flash SPI ROM connector to flash SPI ROM.

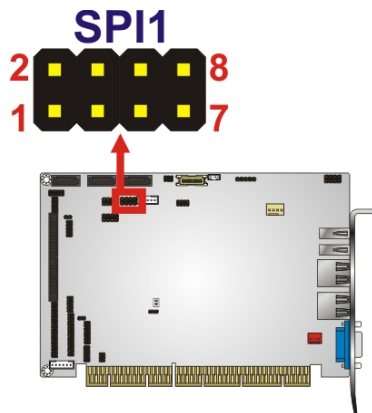

Figure 3-9: Flash SPI ROM Connector Locations

PIN NO.	DESCRIPTION	PIN NO.	DESCRIPTION
1	3.3V	2	GND
3	SPI_CS	4	SPI_CLK
5	SPI_SO	6	SPI_SI
7	NC	8	NC

Table 3-11: Flash SPI ROM Connector Pinouts

3.2.9 Front Panel Connector

- CN Label:** F_PANEL1
- CN Type:** 8-pin header (2x4)
- CN Location:** See **Figure 3-10**
- CN Pinouts:** See **Table 3-12**

The front panel connector connects to several external switches and indicators to monitor and control the motherboard. These indicators and switches include:

- Power LED
- Power button
- Reset button
- HDD LED

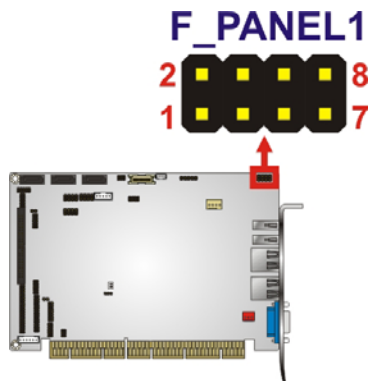

Figure 3-10: Front Panel Connector Location

PCISA-PV-D4251/N4551/D5251 CPU Card

FUNCTION	PIN	DESCRIPTION	FUNCTION	PIN	DESCRIPTION
Power Button	1	PWR_BTN+	Power LED	2	PWR_LED+
	3	PWR_BTN-		4	PWR_LED-
HDD LED	5	HDD_LED+	Reset	6	RESET+
	7	HDD_LED-		8	RESET-

Table 3-12: Front Panel Connector Pinouts

3.2.10 IDE Connector

- CN Label:** IDE1
- CN Type:** 44-pin box header (2x22)
- CN Location:** See **Figure 3-11**
- CN Pinouts:** See **Table 3-13**

One primary 44-pin IDE device connector on the PCISA-PV-D4251/N4551/D5251 supports connectivity to ATA 100/66/33 IDE devices with data transfer rates up to 100MB/s.

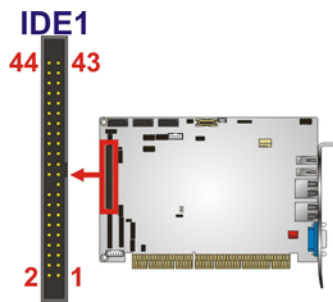

Figure 3-11: IDE Device Connector Location

PIN NO.	DESCRIPTION	PIN NO.	DESCRIPTION
1	RESET#	2	GND
3	DATA 7	4	DATA 8
5	DATA 6	6	DATA 9
7	DATA 5	8	DATA 10
9	DATA 4	10	DATA 11
11	DATA 3	12	DATA 12

PIN NO.	DESCRIPTION	PIN NO.	DESCRIPTION
13	DATA 2	14	DATA 13
15	DATA 1	16	DATA 14
17	DATA 0	18	DATA 15
19	GND	20	N/C
21	IDE DRQ	22	GND
23	IOW#	24	GND
25	IOR#	26	GND
27	IDE IORDY#	28	CSEL
29	IDE DACK	30	GND
31	INT_IRQ14	32	N/C
33	SDA1	34	IDE_PATADET
35	SDA0	36	SDA2
37	IDE CS1#	38	IDE CS3#
39	HDD ACTIVE#	40	GND
41	VCC	42	VCC
43	GND	44	NC

Table 3-13: IDE Connector Pinouts

3.2.11 Infrared Interface Connector

- CN Label:** IR1
- CN Type:** 5-pin header (1x5)
- CN Location:** See **Figure 3-12**
- CN Pinouts:** See **Table 3-14**

The infrared interface connector supports both Serial Infrared (SIR) and Amplitude Shift Key Infrared (ASKIR) interfaces.

PCISA-PV-D4251/N4551/D5251 CPU Card

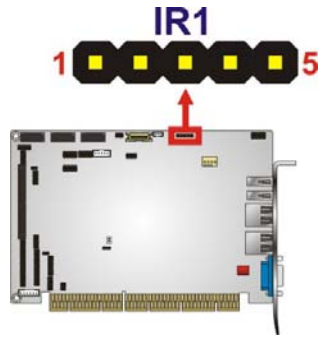

Figure 3-12: Infrared Connector Pinout Locations

PIN NO.	DESCRIPTION
1	VCC
2	NC
3	IR-RX
4	GND
5	IR-TX

Table 3-14: Infrared Connector Pinouts

3.2.12 Keyboard/Mouse Connector

- CN Label:** KB/MS1
- CN Type:** 6-pin wafer (1x6)
- CN Location:** See **Figure 3-13**
- CN Pinouts:** See **Table 3-15**

The keyboard/mouse connector can be connected to a standard PS/2 cable or PS/2 Y cable to add keyboard and mouse functionality to the system.

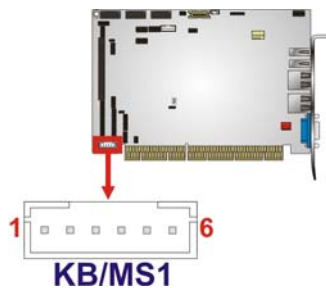

Figure 3-13: Keyboard/Mouse Connector Location

PIN NO.	DESCRIPTION
1	+5 V
2	MS DATA
3	MS CLK
4	KB DATA
5	KB CLK
6	GROUND

Table 3-15: Keyboard/Mouse Connector Pinouts

3.2.13 LCD Backlight Connector

- CN Label:** INV1
- CN Type:** 5-pin wafer (1x5)
- CN Location:** See **Figure 3-14**
- CN Pinouts:** See **Table 3-16**

The LCD backlight connector is for the LCD inverter connection.

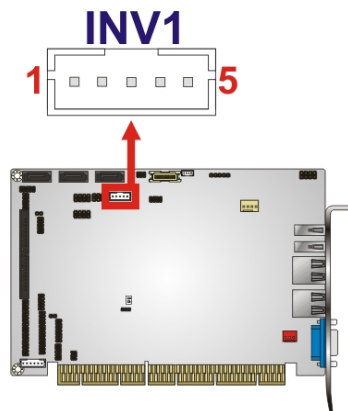

Figure 3-14: LCD Backlight Connector Location

PIN NO.	DESCRIPTION
1	BRIGHTNESS
2	GND1
3	+12 V
4	GND2

PCISA-PV-D4251/N4551/D5251 CPU Card

5	BL_EN
---	-------

Table 3-16: LCD Backlight Connector Pinouts

3.2.14 LVDS LCD connector

- CN Label:** LVDS1
- CN Type:** 20-pin crimp connector (2x10)
- CN Location:** See **Figure 3-15**
- CN Pinouts:** See **Table 3-17**

The connector supports one or one channel 18-bit LVDS panel.

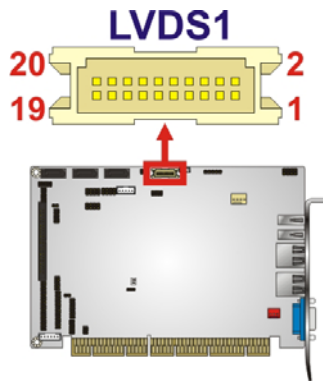

Figure 3-15: LVDS LCD Connector Location

PIN NO.	DESCRIPTION	PIN NO.	DESCRIPTION
1	GND	2	GND
3	LVDSA_DATA0	4	LVDSA_DATA#0
5	LVDSA_DATA1	6	LVDSA_DATA#1
7	LVDSA_DATA2	8	LVDSA_DATA#2
9	LVDSA_CLK	10	LVDSA_CLK#
11	NC	12	NC
13	GND	14	GND
15	NC	16	NC
17	VCC_LCD	18	VCC_LCD
19	VCC_LCD	20	VCC_LCD

Table 3-17: LVDS LCD Connector Pinouts

3.2.15 Parallel Port Connector

- CN Label:** LPT1
- CN Type:** 26-pin header (2x13)
- CN Location:** See **Figure 3-16**
- CN Pinouts:** See **Table 3-18**

The 26-pin parallel port connector connects to a parallel port connector interface or some other parallel port device such as a printer.

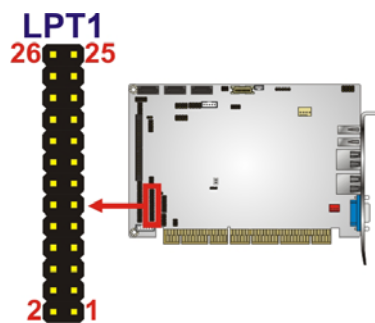

Figure 3-16: Parallel Port Connector Location

PIN NO.	DESCRIPTION	PIN NO.	DESCRIPTION
1	-STB	2	-AFD
3	PTD0	4	-ERR
5	PTD1	6	-INIT
7	PTD2	8	-SLIN
9	PTD3	10	GND
11	PTD4	12	GND
13	PTD5	14	GND
15	PTD6	16	GND
17	PTD7	18	GND
19	-ACK	20	GND
21	BUSY	22	GND
23	PE	24	GND
25	SLCT	26	NC

Table 3-18: Parallel Port Connector Pinouts

PCISA-PV-D4251/N4551/D5251 CPU Card

3.2.16 RS-232 Serial Port Connectors (COM1, COM3 and COM4)

- CN Label:** COM1, COM3 and COM4
- CN Type:** 10-pin header (2x5)
- CN Location:** See **Figure 3-17**
- CN Pinouts:** See **Table 3-19**

The 10-pin serial port connector provides a RS-232 serial communications channel. The COM1, COM3 and COM4 serial port connectors can be connected to external RS-232 serial port devices.

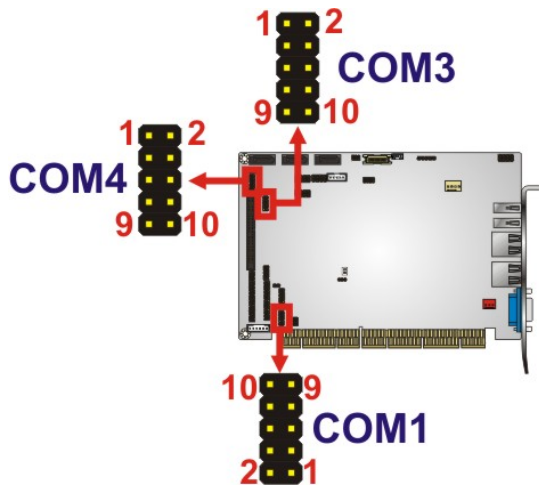

Figure 3-17: RS-232 Connector Pinout Locations

PIN NO.	DESCRIPTION	PIN NO.	DESCRIPTION
1	Data Carrier Direct (DCD)	2	Data Set Ready (DSR)
3	Receive Data (RXD)	4	Request To Send (RTS)
5	Transmit Data (TXD)	6	Clear To Send (CTS)
7	Data Terminal Ready (DTR)	8	Ring Indicator (RI)
9	Ground (GND)	10	Ground (GND)

Table 3-19: RS-232 Connector Pinouts

3.2.17 RS-232/422/485 Serial Port Connector (COM2)

- CN Label:** COM2
- CN Type:** 14-pin header (2x7)
- CN Location:** See **Figure 3-18**
- CN Pinouts:** See **Table 3-20**

The serial ports connectors connect to RS-232/422/485 serial port device.

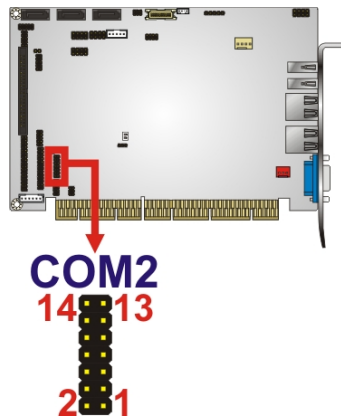

Figure 3-18: COM2 Location

PIN NO.	DESCRIPTION	PIN NO.	DESCRIPTION
1	-NDCDB	2	-NDSRB
3	NSINB	4	-NRTSB
5	NSOUTB	6	-NCTSB
7	-NDTRB	8	-XRI2
9	GND	10	GND
11	TXD422+/TXD485+	12	TXD422-/TXD485-
13	RXD422+	14	RXD422-

Table 3-20: COM2 Pinouts

3.2.18 SATA Drive Connectors

- CN Label:** **SATA1, SATA2 and SATA3**
- CN Type:** 7-pin SATA drive connectors (1x7)

PCISA-PV-D4251/N4551/D5251 CPU Card

CN Location: See **Figure 3-19**

CN Pinouts: See **Table 3-21**

The three SATA drive connectors are connected to three SATA 3Gb/s drives. SATA 3Gb/s drives transfer data at speeds as high as 3Gb/s.

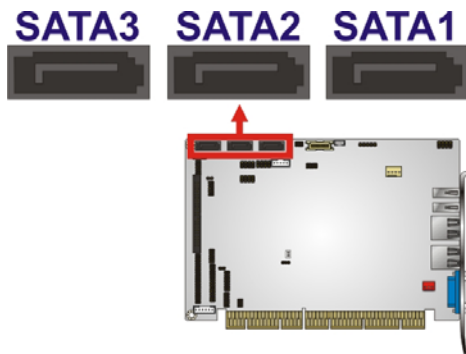

Figure 3-19: SATA Drive Connector Locations

PIN NO.	DESCRIPTION
1	GND
2	TXP
3	TXN
4	GND
5	RXN
6	RXP
7	GND

Table 3-21: SATA Drive Connector Pinouts

3.2.19 SMBus Connector

CN Label: **CN1**

CN Type: 4-pin wafer (1x4)

CN Location: See **Figure 3-20**

CN Pinouts: See **Table 3-22**

The SMBus (System Management Bus) connector provides low-speed system management communications.

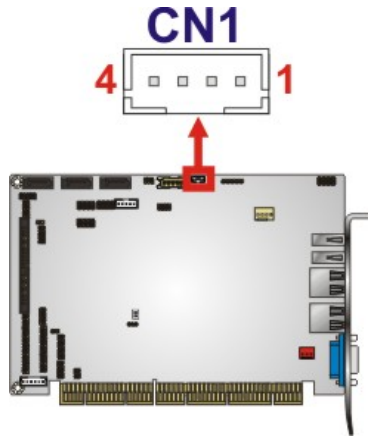

Figure 3-20: SMBus Connector Location

Pin	Description
1	GND
2	SMBDATA
3	SMBCLK
4	+5V

Table 3-22: SMBus Connector Pinouts

3.2.20 USB Connectors (Internal)

CN Label: USB0_1 and USB0_2

CN Type: 8-pin header (2x4)

CN Location: See **Figure 3-21**

CN Pinouts: See **Table 3-23**

One 2x4 pin connector provides connectivity to two USB 2.0 ports. The USB ports are used for I/O bus expansion.

PCISA-PV-D4251/N4551/D5251 CPU Card

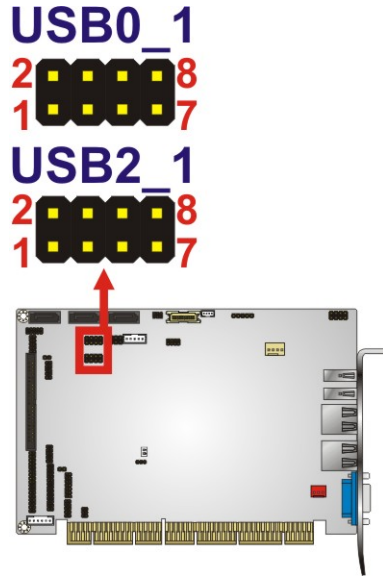

Figure 3-21: Internal USB Connector Locations

PIN NO.	DESCRIPTION	PIN NO.	DESCRIPTION
1	VCC (+5V)	2	GND
3	DATA-	4	DATA+
5	DATA+	6	DATA-
7	GND	8	VCC (+5V)

Table 3-23: USB3 and USB4 Pinouts

3.3 External Peripheral Interface Connector Panel

The figure below shows the external peripheral interface connector (EPIC) panel. The EPIC panel consists of the following:

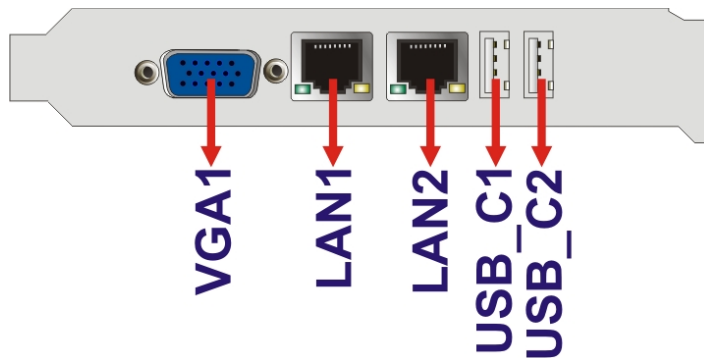

Figure 3-22: External Peripheral Interface Connector

3.3.1 CRT Connector

- CN Label:** VGA1
- CN Type:** 15-pin female connector
- CN Location:** See **Figure 3-22**
- CN Pinouts:** See **Table 3-24** and **Figure 3-23**

The standard 15-pin VGA connector connects to a CRT or LCD display monitor.

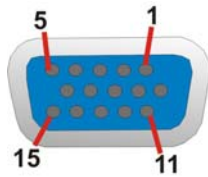

Figure 3-23: VGA Connector

PIN NO.	DESCRIPTION	PIN NO.	DESCRIPTION
1	RED	2	GREEN
3	BLUE	4	N/C
5	GND	6	GND
7	GND	8	GND
9	VCC	10	GND
11	N/C	12	DDC DAT
13	HSYNC	14	VSYNC
15	DDC CLK		

Table 3-24: VGA Connector Pinouts

3.3.2 Ethernet Connectors

- CN Label:** LAN1 and LAN2
- CN Type:** RJ-45
- CN Location:** See **Figure 3-22**
- CN Pinouts:** See **Table 3-25**

The PCISA-PV-D4251/N4551/D5251 is equipped with two built-in GbE Ethernet controllers. The controllers can connect to the LAN through two RJ-45 LAN connectors.

PCISA-PV-D4251/N4551/D5251 CPU Card

There are two LEDs on the connector indicating the status of LAN. The pin assignments are listed in the following table:

PIN	DESCRIPTION	PIN	DESCRIPTION
1	LAN#_MDIO+	10	LAN_MDI3-
2	LAN#_MDIO-	11	LAN#_LINK100
3	LAN#_MDI1+	12	LAN#_LED3/EEDO
4	LAN#_MDI1-	13	LAN#_ACT-1
5	GND	14	VCC
6	GND	15	GND
7	LAN#_MDI2+	16	GND
8	LAN#_MDI2-	17	NC
9	LAN#_MDI3+	18	NC

Table 3-25: LAN1 and LAN2 Pinouts

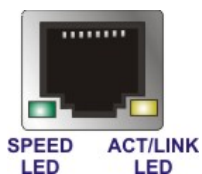

Figure 3-24: RJ-45 Ethernet Connector

The RJ-45 Ethernet connector has two status LEDs, one green and one yellow. The green LED indicates activity on the port and the yellow LED indicates the port is linked. See **Table 3-26**.

SPEED LED		ACT/LINK LED	
STATUS	DESCRIPTION	STATUS	DESCRIPTION
OFF	10Mbps connection	OFF	No link
GREEN	100Mbps connection	YELLOW	Linked
ORANGE	1Gbps connection	BLINKING	Data Activity

Table 3-26: RJ-45 Ethernet Connector LEDs

3.3.3 USB Connector

CN Label: USB_C1 and USB_C2

CN Type: USB port

CN Location: See **Figure 3-22**

CN Pinouts: See **Table 3-27**

USB devices can be connected directly to the USB connectors on the rear panel.

PIN NO.	DESCRIPTION
1	VCC
2	DATA-
3	DATA+
4	GND

Table 3-27: External USB Connector Pinouts

Chapter

4

Installation

4.1 Anti-static Precautions



WARNING:

Failure to take ESD precautions during the installation of the PCISA-PV-D4251/N4551/D5251 may result in permanent damage to the PCISA-PV-D4251/N4551/D5251 and severe injury to the user.

Electrostatic discharge (ESD) can cause serious damage to electronic components, including the PCISA-PV-D4251/N4551/D5251. Dry climates are especially susceptible to ESD. It is therefore critical that whenever the PCISA-PV-D4251/N4551/D5251 or any other electrical component is handled, the following anti-static precautions are strictly adhered to.

- **Wear an anti-static wristband:** Wearing a simple anti-static wristband can help to prevent ESD from damaging the board.
- **Self-grounding:** Before handling the board, touch any grounded conducting material. During the time the board is handled, frequently touch any conducting materials that are connected to the ground.
- **Use an anti-static pad:** When configuring the PCISA-PV-D4251/N4551/D5251, place it on an anti-static pad. This reduces the possibility of ESD damaging the PCISA-PV-D4251/N4551/D5251.
- **Only handle the edges of the PCB:** When handling the PCB, hold the PCB by the edges.

4.2 Installation Considerations



NOTE:

The following installation notices and installation considerations should be read and understood before installation. All installation notices must be strictly adhered to. Failing to adhere to these precautions may lead to severe damage and injury to the person performing the installation.

**WARNING:**

The installation instructions described in this manual should be carefully followed in order to prevent damage to the components and injury to the user.

Before and during the installation please **DO** the following:

- Read the user manual:
 - The user manual provides a complete description of the PCISA-PV-D4251/N4551/D5251 installation instructions and configuration options.
- Wear an electrostatic discharge cuff (ESD):
 - Electronic components are easily damaged by ESD. Wearing an ESD cuff removes ESD from the body and helps prevent ESD damage.
- Place the PCISA-PV-D4251/N4551/D5251 on an antistatic pad:
 - When installing or configuring the motherboard, place it on an antistatic pad. This helps to prevent potential ESD damage.
- Turn all power to the PCISA-PV-D4251/N4551/D5251 off:
 - When working with the PCISA-PV-D4251/N4551/D5251, make sure that it is disconnected from all power supplies and that no electricity is being fed into the system.

Before and during the installation of the PCISA-PV-D4251/N4551/D5251 **DO NOT:**

- Remove any of the stickers on the PCB board. These stickers are required for warranty validation.
- Use the product before verifying all the cables and power connectors are properly connected.
- Allow screws to come in contact with the PCB circuit, connector pins, or its components.

4.3 Basic Installation

This section outlines the parts that must be installed for the system to function correctly.

4.3.1 SO-DIMM Installation

To install an SO-DIMM, please follow the steps below and refer to Figure 4-1.

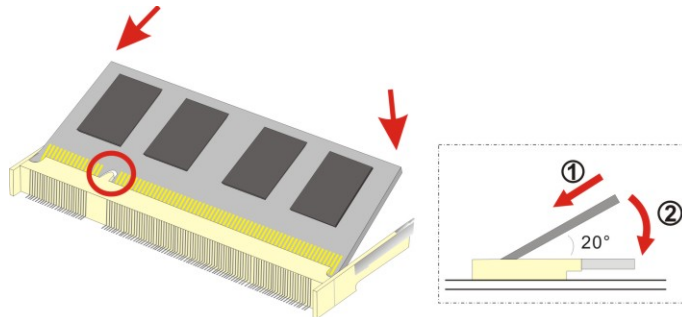

Figure 4-1: SO-DIMM Installation

- Step 1:** Locate the SO-DIMM socket. Place the board on an anti-static mat.
- Step 2:** Align the SO-DIMM with the socket. Align the notch on the memory with the notch on the memory socket.
- Step 3:** Insert the SO-DIMM. Push the memory in at a 20° angle. (See Figure 4-1)
- Step 4:** Seat the SO-DIMM. Gently push downwards and the arms clip into place. (See Figure 4-1)

4.3.2 Airflow



WARNING:

Airflow is critical for keeping components within recommended operating temperatures. The chassis should have fans and vents as necessary to keep things cool.

The PCISA-PV-D4251/N4551/D5251 must be installed in a chassis with ventilation holes on the sides allowing airflow to travel through the heat sink surface. In a system with an

PCISA-PV-D4251/N4551/D5251 CPU Card

individual power supply unit, the cooling fan of a power supply can also help generate airflow through the board surface.

4.3.3 Backplane Installation

Before the PCISA-PV-D4251/N4551/D5251 can be installed into the chassis, a backplane must first be installed. Please refer to the installation instructions that came with the backplane and the chassis to see how to install the backplane into the chassis.



NOTE:

IEI has a wide range of backplanes available. Please contact a vendor, reseller or an IEI sales representative at sales@ieiworld.com or visit the IEI website (<http://www.ieiworld.com>) to find out more about the available chassis.

4.3.4 CPU Card Installation

To install the CPU card onto the backplane, carefully align the CPU card edge connector with the CPU card socket on the backplane. To do this, please refer to the reference material that came with the backplane. Next, secure the CPU card to the chassis. To do this, please refer to the reference material that came with the chassis.

4.3.5 Optional CPU Fan Installation

IEI also provides an optional CPU fan which can be easily installed on the preinstalled CPU heatsink by two push pins. To install the cooling kit, please follow the steps below.

- Step 1: Properly align the CPU fan.** Line up the two push pins with the holes on the CPU heatsink.
- Step 2: Install the CPU fan.** Push the two push pins into the holes on the CPU heatsink.
- Step 3: Connect the fan cable.** Connect the CPU fan cable to the fan connector on the board. Carefully route the cable away from heat generating chips and fan blades.

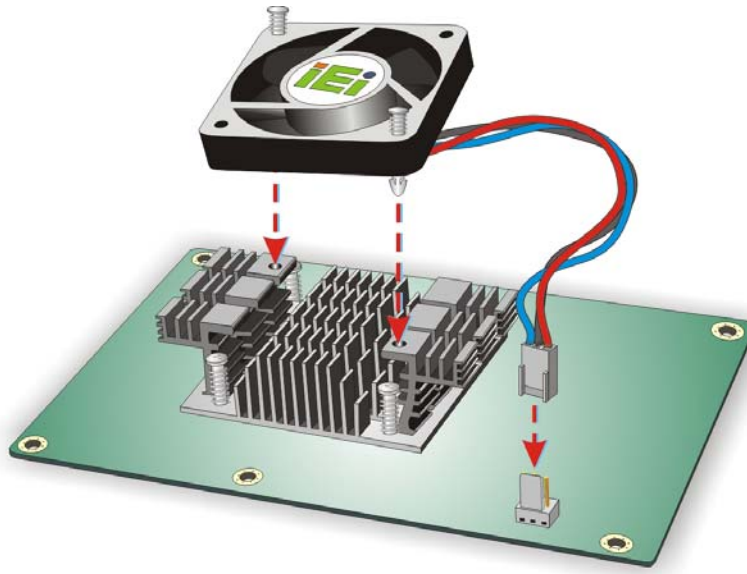

Figure 4-2: Connect Fan Cable

4.4 Jumper Settings



NOTE:

A jumper is a metal bridge used to close an electrical circuit. It consists of two or three metal pins and a small metal clip (often protected by a plastic cover) that slides over the pins to connect them. To CLOSE/SHORT a jumper means connecting the pins of the jumper with the plastic clip and to OPEN a jumper means removing the plastic clip from a jumper.

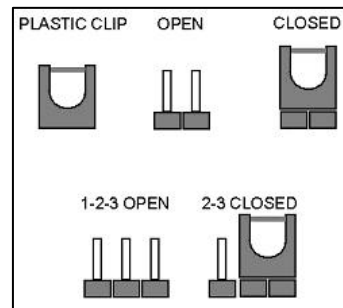

The PCISA-PV-D4251/N4551/D5251 includes one jumper shown in **Table 4-1**.

PCISA-PV-D4251/N4551/D5251 CPU Card

Description	Label	Type
CF card setup	JCF1	2-pin header
Clear CMOS	J_CMOS1	3-pin header
COM 2 function selection	JP2	6-pin header
LVDS LCD voltage selection	J_VLVDS1	6-pin header
LVDS LCD resolution selection	JP3	6-pin header
PCIe interface setup	JP1	2-pin header

Table 4-1: Jumpers

4.4.1 CF Card Setup

- Jumper Label:** JCF1
- Jumper Type:** 2-pin header
- Jumper Settings:** See **Table 4-2**
- Jumper Location:** See **Figure 4-3**

The CF Card Setup jumper sets the CF Type I card or CF Type II cards as either the slave device or the master device. CF Card Setup jumper settings are shown in **Table 4-2**.

CF Card Setup	Description	
Open	Slave	Default
Closed	Master	

Table 4-2: CF Card Setup Jumper Settings

The CF Card Setup jumper location is shown in **Figure 4-3**.

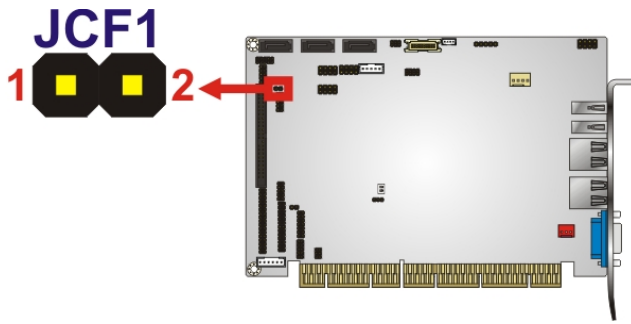

Figure 4-3: CF Card Setup Jumper Location

4.4.2 Clear CMOS Jumper

- Jumper Label:** J_COMS1
- Jumper Type:** 3-pin header
- Jumper Settings:** See **Table 4-3**
- Jumper Location:** See **Figure 4-4**

If the PCISA-PV-D4251/N4551/D5251 fails to boot due to improper BIOS settings, the clear CMOS jumper clears the CMOS data and resets the system BIOS information. To do this, use the jumper cap to close pins 2 and 3 for a few seconds then reinstall the jumper clip back to pins 1 and 2.

If the “CMOS Settings Wrong” message is displayed during the boot up process, the fault may be corrected by pressing the F1 to enter the CMOS Setup menu. Do one of the following:

- Enter the correct CMOS setting
- Load Optimal Defaults
- Load Failsafe Defaults.

After having done one of the above, save the changes and exit the CMOS Setup menu.

Clear CMOS	Description	
Short 1 - 2	Keep CMOS Setup	Default
Short 2 - 3	Clear CMOS Setup	

Table 4-3: Clear CMOS Jumper Settings

PCISA-PV-D4251/N4551/D5251 CPU Card

The location of the clear CMOS jumper is shown in **Figure 4-4** below.

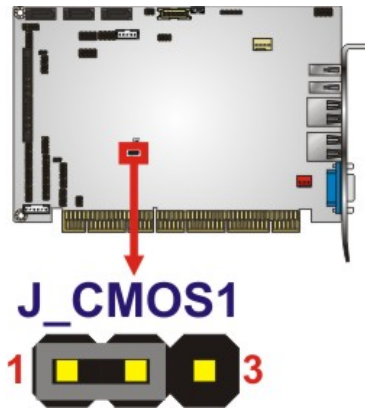

Figure 4-4: Clear CMOS Jumper

4.4.3 COM 2 Function Select Jumper

- Jumper Label:** JP2
- Jumper Type:** 6-pin header
- Jumper Settings:** See **Table 4-4**
- Jumper Location:** See **Figure 4-5**

The COM 2 Function Select jumper sets the communication protocol used by the second serial communications port (COM 2) as RS-232, RS-422 or RS-485. The COM 2 Function Select settings are shown in **Table 4-4**.

COM 2 Function Select	Description	
Short 1-2	RS-232	Default
Short 3-4	RS-422	
Short 5-6	RS-485	

Table 4-4: COM 2 Function Select Jumper Settings

The COM 2 Function Select jumper location is shown in **Figure 4-5**.

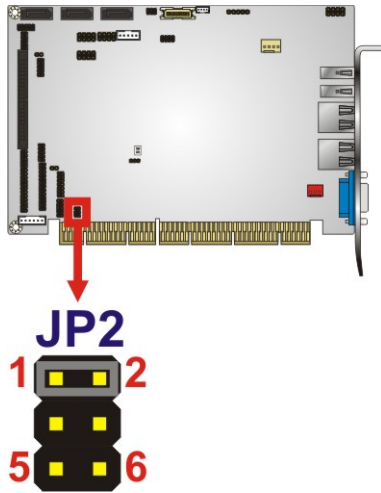

Figure 4-5: COM 2 Function Select Jumper Location

4.4.4 LVDS Voltage Selection



WARNING:

Permanent damage to the screen and PCISA-PV-D4251/N4551/D5251 may occur if the wrong voltage is selected with this jumper. Please refer to the user guide that came with the monitor to select the correct voltage.

- Jumper Label:** J_VLVDS1
- Jumper Type:** 6-pin header
- Jumper Settings:** See **Table 4-5**
- Jumper Location:** See **Figure 4-6**

The **LVDS Voltage Selection** jumper allows the LVDS screen voltage to be set. The **LVDS Voltage Selection** jumper settings are shown in **Table 4-5**.

LVDS Voltage Select	Description	
Short 1-2	+3.3 V	Default
Short 2-3	+5 V	

PCISA-PV-D4251/N4551/D5251 CPU Card

Short 5-6	+12 V	
-----------	-------	--

Table 4-5: LVDS Voltage Selection Jumper Settings

The LVDS Voltage Selection jumper location is shown in Figure 4-6.

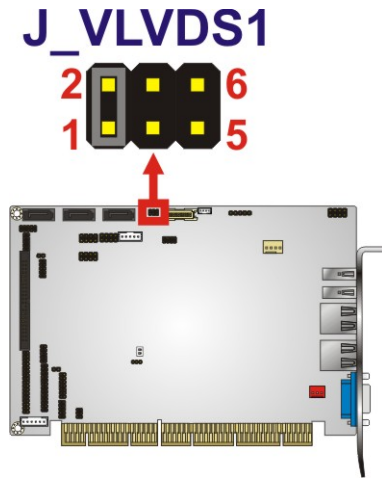

Figure 4-6: LVDS Voltage Selection Jumper Pinout Locations

4.4.5 LVDS Panel Resolution Selection

- Jumper Label:** JP3
- Jumper Type:** 6-pin header
- Jumper Settings:** See Table 4-6
- Jumper Location:** See Figure 4-7

The LVDS Panel Resolution Selection jumper allows the LVDS screen resolution to be set. The LVDS Panel Resolution Selection jumper settings are shown in Table 4-6.

LVDS Resolution Select	Description	
Open	640 x 480 (18-bit)	
Short 1-2	800 x 480 (18-bit)	
Short 3-4	800 x 600 (18-bit)	
Short 5-6	1280 x 1024 (18-bit)	
Short 1-2, 3-4	1024 x 768 (18-bit)	Default
Short 1-2, 5-6	1366 x 768 (18-bit)	

Short 3-4, 5-6	1280 x 800 (18-bit)	
Short 1-2, 3-4, 5-6	1280 x 600 (18-bit)	

Table 4-6: LVDS Resolution Selection Jumper Settings

The LVDS Voltage Selection jumper location is shown in **Figure 4-7**.

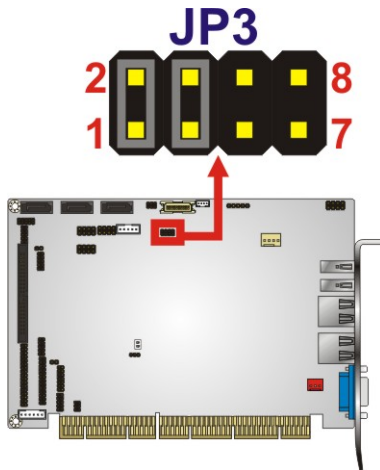

Figure 4-7: LVDS Resolution Selection Jumper Pinout Locations

4.4.6 PCIe Interface Setup

- Jumper Label:** JP1
- Jumper Type:** 2-pin header
- Jumper Settings:** See **Table 4-7**
- Jumper Location:** See **Figure 4-8**

This jumper sets the PCIe slot as PCIe x4 or PCIe x1.

Setting	Description
Short	Four PCIe x1
Close	One PCIe x4

Table 4-7: PCIe Slot Jumper Setting

PCISA-PV-D4251/N4551/D5251 CPU Card

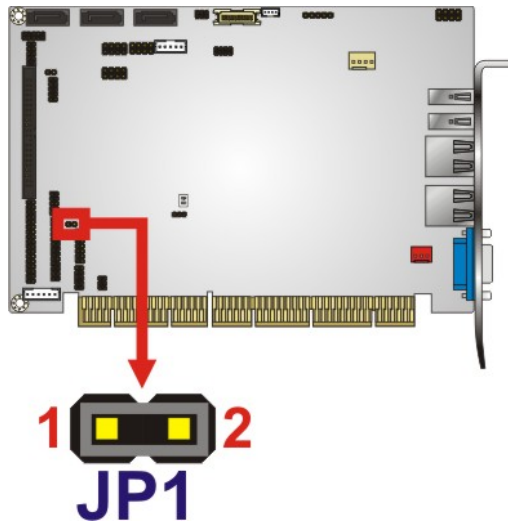

Figure 4-8: PCIe Slot Jumper Location

4.5 Internal Peripheral Device Connections

This section outlines the installation of peripheral devices to the onboard connectors.

4.5.1 SATA Drive Connection

The PCISA-PV-D4251/N4551/D5251 is shipped with three SATA drive cables. To connect the SATA drives to the connectors, please follow the steps below.

Step 1: **Locate the connectors.** The locations of the SATA drive connectors are shown in **Chapter 3**.

Step 2: **Insert the cable connector** into the on-board SATA drive connector. See **Figure 4-9**.

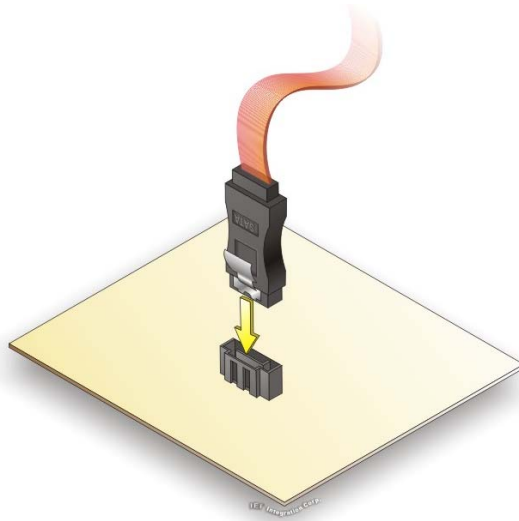

Figure 4-9: SATA Drive Cable Connection

Step 3: Connect the cable to the SATA disk. Connect the connector on the other end of the cable to the connector at the back of the SATA drive. See **Figure 4-10**.

Step 4: Connect the SATA power cable. Connect the SATA power connector to the back of the SATA drive. See **Figure 4-10**.

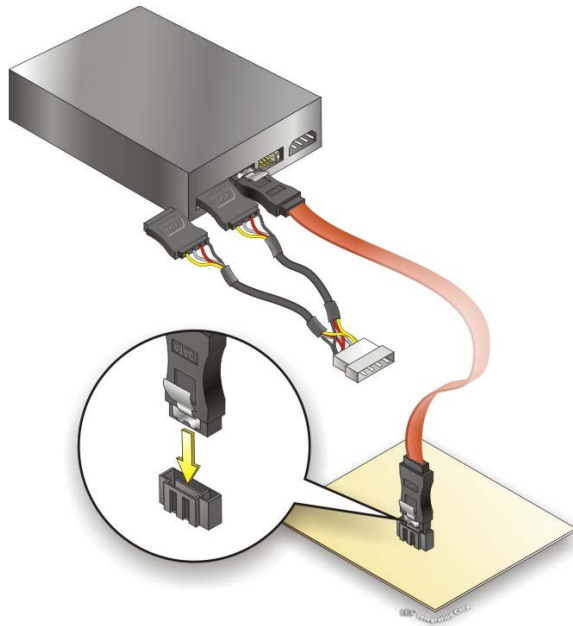

Figure 4-10: SATA Power Drive Connection

PCISA-PV-D4251/N4551/D5251 CPU Card

4.5.2 USB Cable (Dual Port) with Slot Bracket

The PCISA-PV-D4251/N4551/D5251 is shipped with a dual port USB 2.0 cable. To connect the USB cable connector, please follow the steps below.

Step 1: Locate the connectors. The locations of the USB connectors are shown in Chapter 3.



WARNING:

If the USB pins are not properly aligned, the USB device can burn out.

Step 2: Align the connectors. The cable has two connectors. Correctly align pin 1 of the cable connector with pin 1 on the PCISA-PV-D4251/N4551/D5251 USB connector.

Step 3: Insert the cable connectors Once the cable connectors are properly aligned with the USB connectors on the PCISA-PV-D4251/N4551/D5251, connect the cable connectors to the on-board connectors. See **Figure 4-11**.

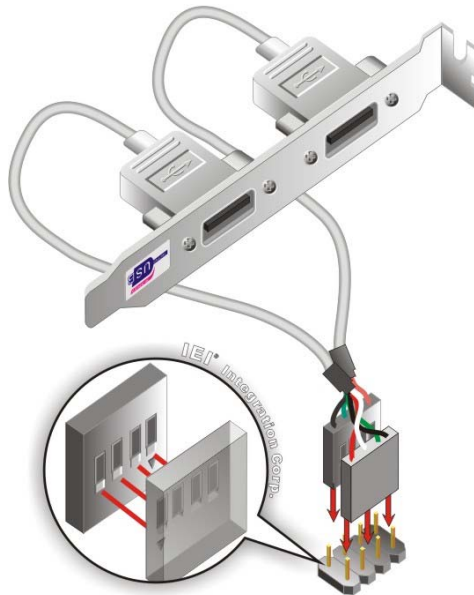

Figure 4-11: Dual USB Cable Connection

Step 4: Attach the bracket to the chassis. The USB 2.0 connectors are attached to a bracket. To secure the bracket to the chassis please refer to the installation instructions that came with the chassis.

4.6 Software Installation

All the drivers for the PCISA-PV-D4251/N4551/D5251 are on the CD that came with the system. To install the drivers, please follow the steps below.

Step 1: Insert the CD into a CD drive connected to the system.



NOTE:

If the installation program doesn't start automatically:
Click "Start->My Computer->CD Drive->autorun.exe"

Step 2: The driver main menu appears.

Step 3: Click PCISA-PV-D4251/N4551/D5251.

Step 4: A new screen with a list of available drivers appears.

Step 5: Install all of the necessary drivers in this menu.

Chapter

5

BIOS

5.1 Introduction

The BIOS is programmed onto the BIOS chip. The BIOS setup program allows changes to certain system settings. This chapter outlines the options that can be changed.



NOTE:

Some of the BIOS options may vary throughout the life cycle of the product and are subject to change without prior notice.

5.1.1 Starting Setup

The UEFI BIOS is activated when the computer is turned on. The setup program can be activated in one of two ways.

1. Press the **F2** key as soon as the system is turned on or
2. Press the **F2** key when the “**Press F2 to enter SETUP**” message appears on the screen.

If the message disappears before the **F2** key is pressed, restart the computer and try again.

5.1.2 Using Setup

Use the arrow keys to highlight items, press **ENTER** to select, use the PageUp and PageDown keys to change entries, press **F1** for help and press **ESC** to quit. Navigation keys are shown in.

Key	Function
Up arrow	Move to previous item
Down arrow	Move to next item
Left arrow	Move to the item on the left hand side
Right arrow	Move to the item on the right hand side

PCISA-PV-D4251/N4551/D5251 CPU Card

Key	Function
F1 key	General help, only for Status Page Setup Menu and Option Page Setup Menu
F2 key	Load previous values.
F3 key	Load optimized defaults
F4 key	Save all the CMOS changes
Esc key	Main Menu – Quit and not save changes into CMOS Status Page Setup Menu and Option Page Setup Menu -- Exit current page and return to Main Menu

Table 5-1: BIOS Navigation Keys

5.1.3 Getting Help

When **F1** is pressed a small help window describing the appropriate keys to use and the possible selections for the highlighted item appears. To exit the Help Window press **Esc** or the **F1** key again.

5.1.4 Unable to Reboot After Configuration Changes

If the computer cannot boot after changes to the system configuration is made, CMOS defaults. Use the jumper described in **Chapter 4**.

5.1.5 BIOS Menu Bar

The **menu bar** on top of the BIOS screen has the following main items:

- Main – Changes the basic system configuration.
- Advanced – Changes the advanced system settings.
- Chipset – Changes the chipset settings.
- Boot – Changes the system boot configuration.
- Security – Sets User and Supervisor Passwords.
- Save & Exit – Selects exit options and loads default settings

The following sections completely describe the configuration options found in the menu items at the top of the BIOS screen and listed above.

5.2 Main

The **Main** BIOS menu (**BIOS Menu 1**) appears when the **BIOS Setup** program is entered. The **Main** menu gives an overview of the basic system information.

```

Aptio Setup Utility - Copyright (C) 2010 American Megatrends, Inc.
Main  Advanced  Chipset  Boot  Security  Save & Exit

BIOS Information
BIOS Vendor                American Megatrends
Core Version               4.6.4.0 0.20
Compliancy                 UEFI 2.0
Project Version            SA12AR11.ROM
Build Date                 08/18/2010 09:00:13

System Date                [Tue 05/06/2008]
System Time                [14:20:27]

Access Level               Administrator

Set the Time. Use Tab to
switch between Time
elements.

-----
<->: Select Screen
↑ ↓: Select Item
Enter>Select
F1  General Help
F2  Previous Values
F3  Optimized Defaults
F4  Save
ESC Exit

Version 2.01.1204. Copyright (C) 2010 American Megatrends, Inc.
    
```

BIOS Menu 1: Main

→ BIOS Information

The **BIOS Information** lists a brief summary of the BIOS. The fields in **BIOS Information** cannot be changed. The items shown in the system overview include:

- **BIOS Vendor:** Installed BIOS vendor
- **Core Version:** Current BIOS version
- **Project Version:** the board version
- **Build Date:** Date the current BIOS version was made

The System Overview field also has two user configurable fields:

→ System Date [xx/xx/xx]

Use the **System Date** option to set the system date. Manually enter the day, month and year.

PCISA-PV-D4251/N4551/D5251 CPU Card

→ System Time [xx:xx:xx]

Use the **System Time** option to set the system time. Manually enter the hours, minutes and seconds.

5.3 Advanced

Use the **Advanced** menu (**BIOS Menu 2**) to configure the CPU and peripheral devices through the following sub-menus:



WARNING!

Setting the wrong values in the sections below may cause the system to malfunction. Make sure that the settings made are compatible with the hardware.

```

Aptio Setup Utility - Copyright (C) 2010 American Megatrends, Inc.
Main  Advanced  Chipset  Boot  Security  Save & Exit
-----
> Trusted Computing
> CPU Configuration
> SATA Configuration
> USB Configuration
> Super IO Configuration
> H/M Monitor
> Serial Port Console Redirection

System ACPI Parameters
-----
<=>: Select Screen
↑ ↓: Select Item
Enter>Select
F1  General Help
F2  Previous Values
F3  Optimized
Defaults
F4  Save
ESC Exit

Version 2.01.1204. Copyright (C) 2010 American Megatrends, Inc.
    
```

BIOS Menu 2: Advanced

5.3.1 Trusted Computing

Use the **Trusted Computing** menu (**BIOS Menu 3**) to configure settings related to the Trusted Computing Group (TCG) Trusted Platform Module (TPM).

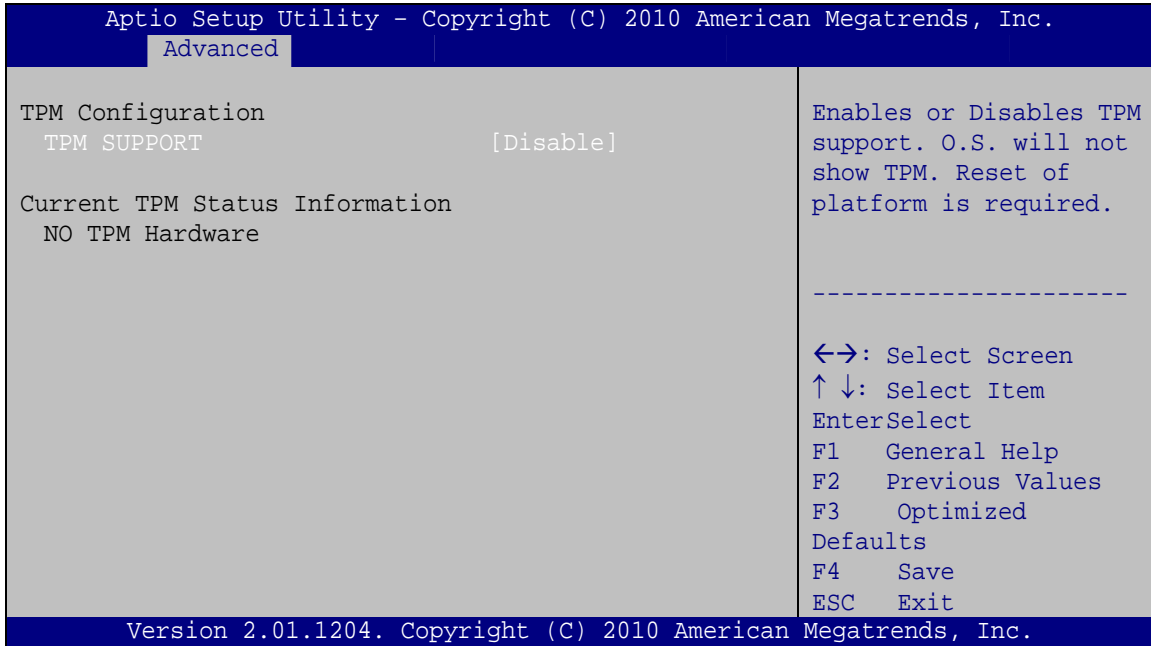

BIOS Menu 3: TPM Configuration

➔ **TPM Support [Disable]**

Use the **TPM Support** option to configure support for the TPM.

- ➔ **Disable** **DEFAULT** TPM support is disabled.
- ➔ **Enable** TPM support is enabled.

5.3.2 CPU Configuration

Use the **CPU Configuration** menu (**BIOS Menu 4**) to view detailed CPU specifications and configure the CPU.

PCISA-PV-D4251/N4551/D5251 CPU Card

Aptio Setup Utility - Copyright (C) 2010 American Megatrends, Inc.		
Advanced		
CPU Configuration		
Processor Type	Intel(R) Atom(TM) CPU	
EMT64	Supported	-----
Processor Speed	1834 MHz	
System Bus Speed	667 MHz	←→: Select Screen
Ratio Status	11	↑ ↓: Select Item
Actual Ratio	11	Enter Select
Processor Stepping	106ca	F1 General Help
Microcode Revision	263	F2 Previous Values
L1 Cache RAM	56 k	F3 Optimized
L2 Cache RAM	512 k	Defaults
Processor Core	Single	F4 Save
Hyper-Threading	Supported	ESC Exit
Version 2.01.1204. Copyright (C) 2010 American Megatrends, Inc.		

BIOS Menu 4: CPU Configuration

The CPU Configuration menu (**BIOS Menu 4**) lists the following CPU details:

- Processor Type: Lists the brand name of the CPU being used
- EMT64: Indicates if the EM64T is supported by the CPU.
- Processor Speed: Lists the CPU processing speed
- System Bus: Lists the system bus
- Ratio Status: List the maximum FSB divisor
- Actual Ratio: Lists current FSB divisor
- Processor Stepping: Lists the CPU processing stepping
- Microcode Revision: Lists the microcode revision
- L1 Cache RAM: Lists the CPU L1 cache size
- L2 Cache RAM: Lists the CPU L2 cache size
- Processor Core: Lists the number of the processor core
- Hyper-Threading: Indicates if the Intel Hyper-Threading Technology is supported by the CPU.

5.3.3 SATA Configuration

Use the **SATA Configuration** menu (**BIOS Menu 5**) to change and/or set the configuration of the SATA devices installed in the system.

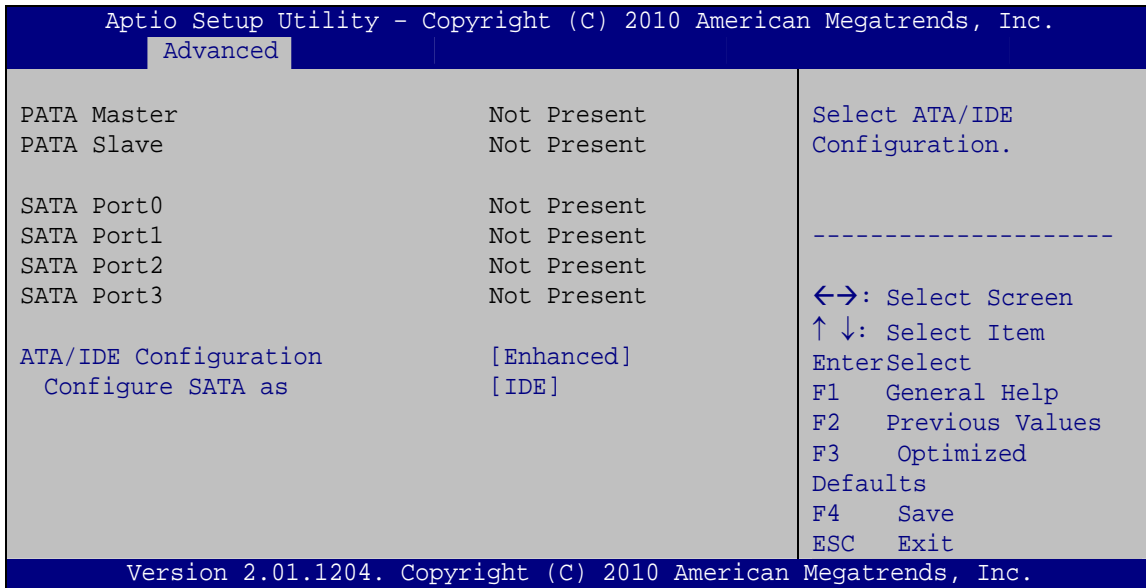

BIOS Menu 5: IDE Configuration

→ ATA/IDE Configurations [Enhanced]

Use the **ATA/IDE Configurations** option to configure the ATA/IDE controller.

- **Disabled** Disables the on-board ATA/IDE controller.
- **Compatible** Configures the on-board ATA/IDE controller to be in compatible mode. In this mode, a SATA channel will replace one of the IDE channels. This mode supports up to 4 storage devices.
- **Enhanced** **DEFAULT** Configures the on-board ATA/IDE controller to be in Enhanced mode. In this mode, IDE channels and SATA channels are separated. This mode supports up to 6 storage devices. Some legacy OS do not support this mode.

PCISA-PV-D4251/N4551/D5251 CPU Card

→ Configure SATA as [IDE]

Use the **Configure SATA as** option to configure SATA devices as normal IDE devices.

- **IDE** **DEFAULT** Configures SATA devices as normal IDE device.
- **AHCI** Configures SATA devices as AHCI device.

5.3.4 USB Configuration

Use the **USB Configuration** menu (**BIOS Menu 6**) to read USB configuration information and configure the USB settings.

```

Aptio Setup Utility - Copyright (C) 2010 American Megatrends, Inc.
  Advanced
-----
USB Configuration
USB Devices:
  1 Keyboard, 2 Hubs
Legacy USB Support                [Enabled]
-----
                                  Enables Legacy USB
                                  support. AUTO option
                                  disables legacy support
                                  if no USB devices are
                                  connected. DISABLE
                                  option will keep USB
                                  devices available only
                                  for EFI applications.
-----
                                  <->: Select Screen
                                  ↑ ↓: Select Item
                                  Enter>Select
                                  F1   General Help
                                  F2   Previous Values
                                  F3   Optimized
                                  Defaults
                                  F4   Save
                                  ESC  Exit
-----
Version 2.01.1204. Copyright (C) 2010 American Megatrends, Inc.
  
```

BIOS Menu 6: USB Configuration

→ USB Devices

The **USB Devices Enabled** field lists the USB devices that are enabled on the system

➔ **Legacy USB Support [Enabled]**

Use the **Legacy USB Support** BIOS option to enable USB mouse and USB keyboard support. Normally if this option is not enabled, any attached USB mouse or USB keyboard does not become available until a USB compatible operating system is fully booted with all USB drivers loaded. When this option is enabled, any attached USB mouse or USB keyboard can control the system even when there is no USB driver loaded onto the system.

- ➔ **Enabled** **DEFAULT** Legacy USB support enabled
- ➔ **Disabled** Legacy USB support disabled
- ➔ **Auto** Legacy USB support disabled if no USB devices are connected

5.3.5 Super IO Configuration

Use the **Super IO Configuration** menu (**BIOS Menu 7**) to set or change the configurations for the FDD controllers, parallel ports and serial ports.

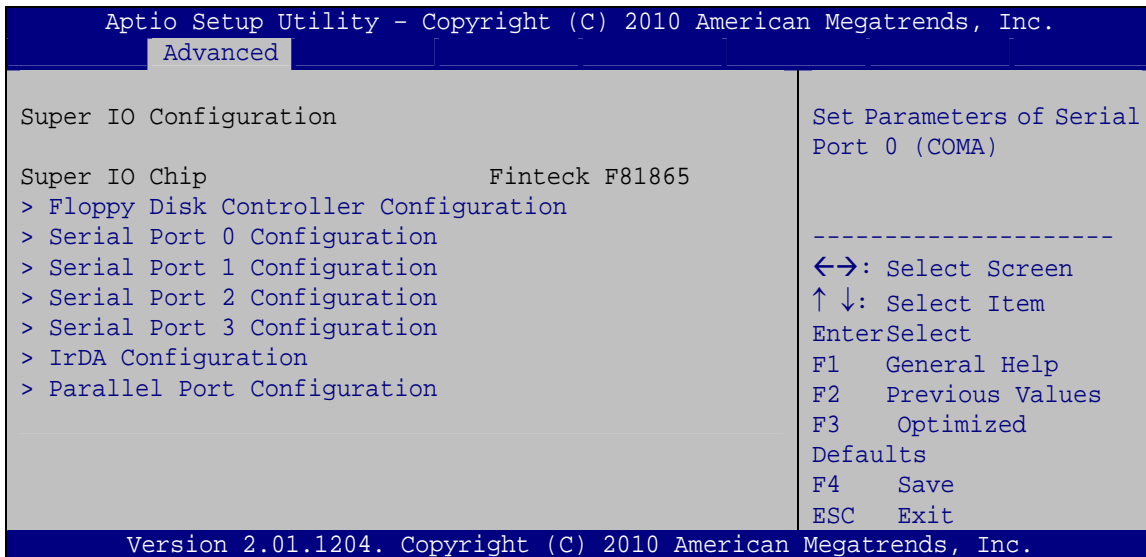

BIOS Menu 7: Super IO Configuration

PCISA-PV-D4251/N4551/D5251 CPU Card

5.3.5.1 Floppy Disk Controller Configuration

Use the **Serial Port n Configuration** menu (**BIOS Menu 9**) to configure the serial port n.

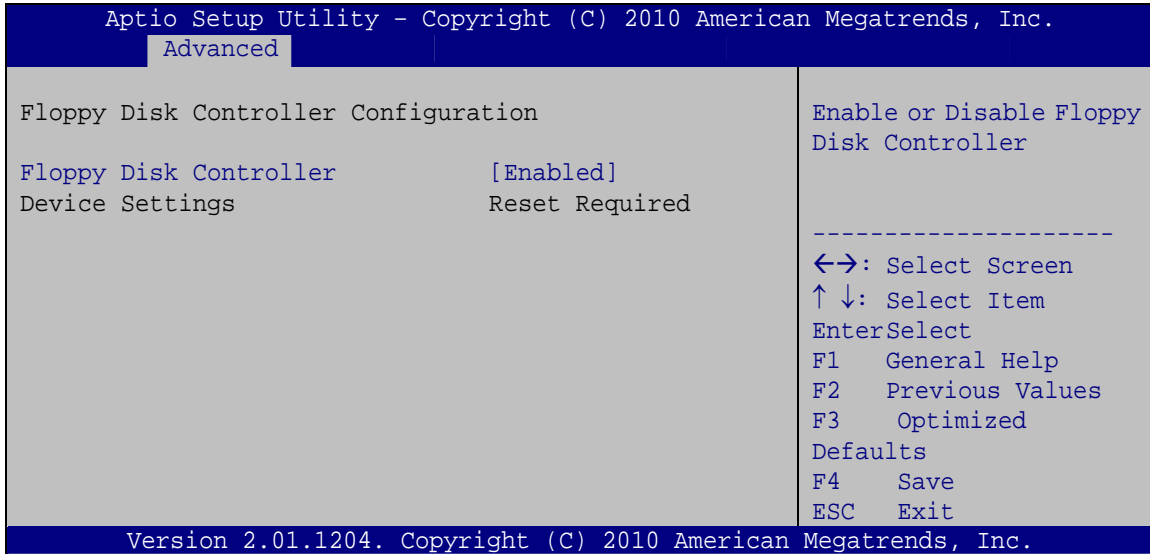

BIOS Menu 8: Floppy Disk Controller Configuration Menu

→ Floppy Disk Controller [Enabled]

Use the **Floppy Disk Controller** option to enable or disable the floppy disk controller.

- **Disabled** Disable the floppy disk controller
- **Enabled** **DEFAULT** Enable the floppy disk controller

5.3.5.2 Serial Port n Configuration

Use the **Serial Port n Configuration** menu (**BIOS Menu 9**) to configure the serial port n.

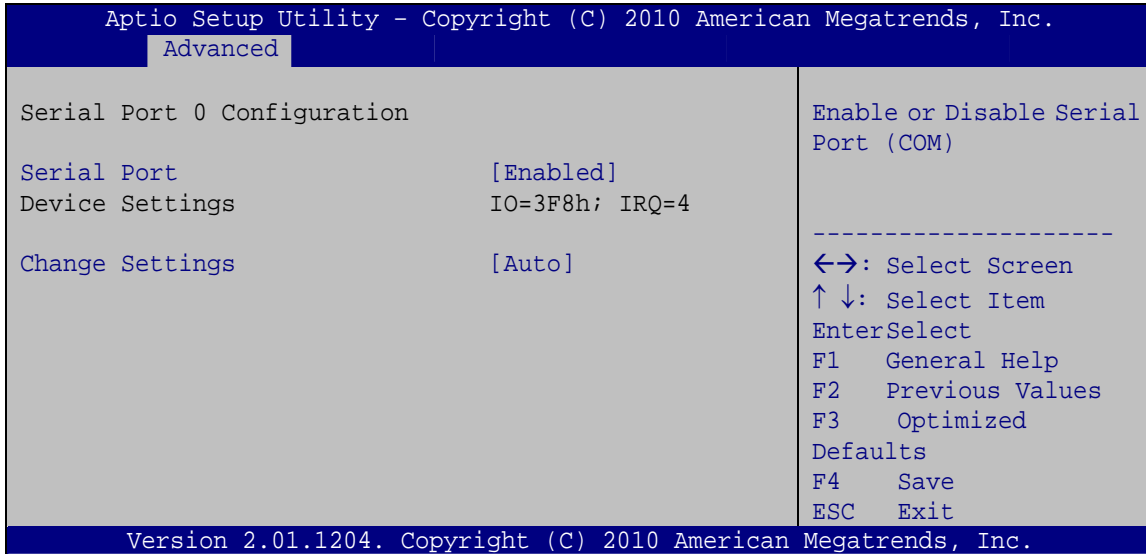

BIOS Menu 9: Serial Port n Configuration Menu

5.3.5.2.1 Serial Port 0 Configuration

→ Serial Port [Enabled]

Use the **Serial Port** option to enable or disable the serial port.

- **Disabled** Disable the serial port
- **Enabled** **DEFAULT** Enable the serial port

→ Change Settings [Auto]

Use the **Change Settings** option to change the serial port IO port address and interrupt address.

- **Auto** **DEFAULT** The serial port IO port address and interrupt address are automatically detected.
- **IO=3F8h;**
IRQ=4 Serial Port I/O port address is 3F8h and the interrupt address is IRQ4

PCISA-PV-D4251/N4551/D5251 CPU Card

- ➔ **IO=3F8h;**
IRQ=3, 4 Serial Port I/O port address is 3F8h and the interrupt address is IRQ3 and IRQ4
- ➔ **IO=2F8h;**
IRQ=3, 4 Serial Port I/O port address is 2F8h and the interrupt address is IRQ3 and IRQ4

5.3.5.2.2 Serial Port 1 Configuration

➔ Serial Port [Enabled]

Use the **Serial Port** option to enable or disable the serial port.

- ➔ **Disabled** Disable the serial port
- ➔ **Enabled** **DEFAULT** Enable the serial port

➔ Change Settings [Auto]

Use the **Change Settings** option to change the serial port IO port address and interrupt address.

- ➔ **Auto** **DEFAULT** The serial port IO port address and interrupt address are automatically detected.
- ➔ **IO=2F8h;**
IRQ=3 Serial Port I/O port address is 2F8h and the interrupt address is IRQ3
- ➔ **IO=3F8h;**
IRQ=3, 4 Serial Port I/O port address is 3F8h and the interrupt address is IRQ3 and IRQ4
- ➔ **IO=2F8h;**
IRQ=3, 4 Serial Port I/O port address is 2F8h and the interrupt address is IRQ3 and IRQ4

5.3.5.2.3 Serial Port 2 Configuration

➔ Serial Port [Enabled]

Use the **Serial Port** option to enable or disable the serial port.

- ➔ **Disabled** Disable the serial port

→ **Enabled** **DEFAULT** Enable the serial port

→ **Change Settings [Auto]**

Use the **Change Settings** option to change the serial port IO port address and interrupt address.

→ **Auto** **DEFAULT** The serial port IO port address and interrupt address are automatically detected.

→ **IO=3E8h;**
IRQ=11 Serial Port I/O port address is 3E8h and the interrupt address is IRQ11

→ **IO=3E8h;**
IRQ=10, 11 Serial Port I/O port address is 3E8h and the interrupt address is IRQ10, 11

→ **IO=2E8h;**
IRQ=10, 11 Serial Port I/O port address is 2E8h and the interrupt address is IRQ10, 11

5.3.5.2.4 Serial Port 3 Configuration

→ **Serial Port [Enabled]**

Use the **Serial Port** option to enable or disable the serial port.

→ **Disabled** Disable the serial port

→ **Enabled** **DEFAULT** Enable the serial port

→ **Change Settings [Auto]**

Use the **Change Settings** option to change the serial port IO port address and interrupt address.

→ **Auto** **DEFAULT** The serial port IO port address and interrupt address are automatically detected.

PCISA-PV-D4251/N4551/D5251 CPU Card

- ➔ **IO=2E8h;**
IRQ=10 Serial Port I/O port address is 2E8h and the interrupt address is IRQ10
- ➔ **IO=3E8h;**
IRQ=10, 11 Serial Port I/O port address is 3E8h and the interrupt address is IRQ10, 11
- ➔ **IO=2E8h;**
IRQ=10, 11 Serial Port I/O port address is 2E8h and the interrupt address is IRQ10, 11

5.3.5.3 IrDA Configuration

Use the **IrDA Configuration** menu (**BIOS Menu 9**) to configure the serial port n.

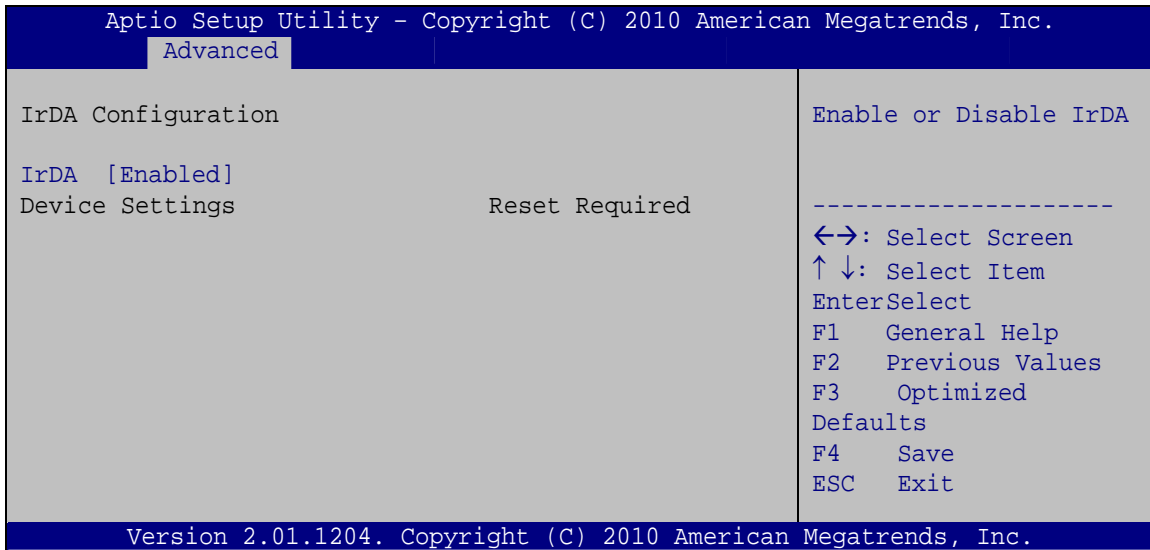

BIOS Menu 10: IrDA Configuration Menu

- ➔ **IrDA [Enabled]**

Use the **IrDA** option to enable or disable the infrared function.

- ➔ **Disabled** Disable the infrared function
- ➔ **Enabled DEFAULT** Enable the infrared function

5.3.5.4 Parallel Port Configuration

Use the **Parallel Port Configuration** menu (**BIOS Menu 9**) to configure the serial port n.

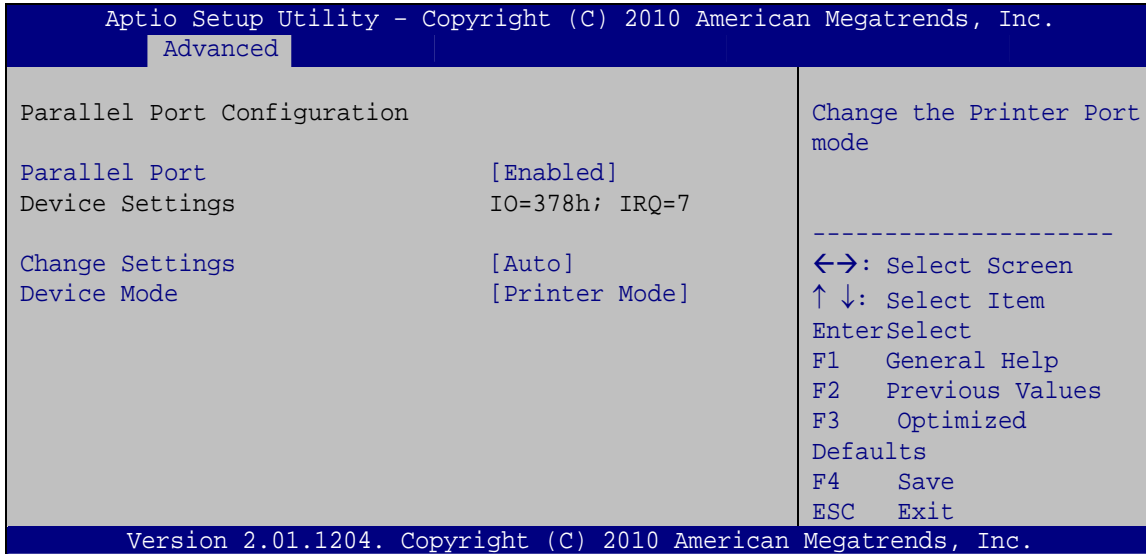

BIOS Menu 11: Parallel Port Configuration Menu

→ Parallel Port [Enabled]

Use the **Parallel Port** option to enable or disable the parallel port.

- **Disabled** Disable the parallel port
- **Enabled** **DEFAULT** Enable the parallel port

→ Change Settings [Auto]

Use the **Change Settings** option to change the parallel port IO port address and interrupt address.

- **Auto** **DEFAULT** The parallel port IO port address and interrupt address are automatically detected.
- **IO=378h; IRQ=7** Parallel Port I/O port address is 378h and the interrupt address is IRQ7
- **IO=278h; IRQ=7** Parallel Port I/O port address is 278h and the interrupt address is IRQ7

PCISA-PV-D4251/N4551/D5251 CPU Card

- | | |
|---------------------|--|
| → IO=3BCh;
IRQ=7 | Parallel Port I/O port address is 3BCh and the interrupt address is IRQ7 |
| → IO=378h | Parallel Port I/O port address is 378h |
| → IO=278h | Parallel Port I/O port address is 278h |
| → IO=3BCh | Parallel Port I/O port address is 3BCh |

→ Device Mode [Printer Mode]

Use the **Device Mode** option to select the mode the parallel port operates in. Configuration options are listed below.

- | | |
|------------------------|----------------|
| ▪ Printer Mode | Default |
| ▪ SPP Mode | |
| ▪ EPP-1.9 and SPP Mode | |
| ▪ EPP-1.7 and SPP Mode | |
| ▪ ECP Mode | |
| ▪ ECP and EPP 1.9 Mode | |
| ▪ ECP and EPP 1.7 Mode | |

5.3.6 H/W Monitor

The H/W Monitor menu (**BIOS Menu 12**) shows the operating temperature, fan speeds and system voltages.

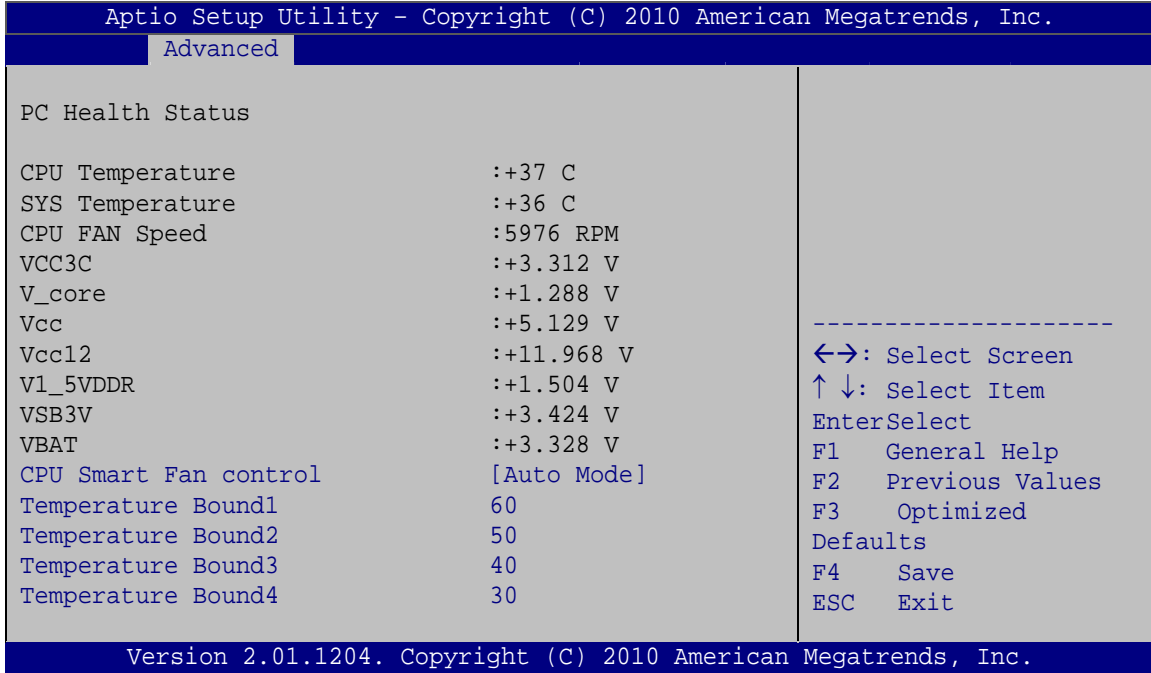

BIOS Menu 12: Hardware Health Configuration

➔ **PC Health Status**

The following system parameters and values are shown. The system parameters that are monitored are:

- System Temperatures:
 - CPU Temperature
 - System Temperature
- Fan Speeds:
 - CPU Fan Speed
- Voltages:
 - V_core
 - Vcc
 - Vcc12
 - V1_5VDDR
 - VSB3V
 - VBAT

PCISA-PV-D4251/N4551/D5251 CPU Card

→ CPU Smart Fan control [Auto Mode]

Use the **CPU Smart Fan control** option to configure the CPU fan.

→ Auto Mode

The fan adjusts its speed using these settings:

Temperature Bound 1

Temperature Bound 2

Temperature Bound 3

Temperature Bound 4

→ Manual Mode

The fan spins at the speed set in:

Manual Duty Cycle Setting

5.3.7 Serial Port Console Redirection

The **Serial Port Console Redirection** menu (**BIOS Menu 13**) allows the console redirection options to be configured. Console redirection allows users to maintain a system remotely by re-directing keyboard input and text output through the serial port.

```

Aptio Setup Utility - Copyright (C) 2010 American Megatrends, Inc.
  Advanced
COM0
  Console Redirection [Disabled]
  > Console Redirection Settings
COM1
  Console Redirection [Disabled]
  > Console Redirection Settings
COM2
  Console Redirection [Disabled]
  > Console Redirection Settings
COM3
  Console Redirection [Disabled]
  > Console Redirection Settings
  Console Redirection
  Enable/Disable
-----
  ←→: Select Screen
  ↑ ↓: Select Item
  Enter>Select
  F1  General Help
  F2  Previous Values
  F3  Optimized
  Defaults
  F4  Save
  ESC Exit
Version 2.01.1204. Copyright (C) 2010 American Megatrends, Inc.
  
```

BIOS Menu 13: Serial Port Console Redirection

→ Console Redirection [Disabled]

Use **Console Redirection** option to enable or disable the console redirection function.

- ➔ **Disabled** **DEFAULT** Disabled the console redirection function
- ➔ **Enabled** Enabled the console redirection function

5.4 Chipset

Use the **Chipset** menu (**BIOS Menu 14**) to access the Northbridge and Southbridge configuration menus



WARNING!

Setting the wrong values for the Chipset BIOS selections in the Chipset BIOS menu may cause the system to malfunction.

```

Aptio Setup Utility - Copyright (C) 2010 American Megatrends, Inc.
Main   Advanced  Chipset  Boot   Security  Save & Exit
-----
> Host Bridge
> South Bridge
> Intel IGD SWSCI OpRegion

North Bridge Parameters
-----
<=>: Select Screen
↑ ↓: Select Item
EnterSelect
F1   General Help
F2   Previous Values
F3   Optimized
Defaults
F4   Save
ESC  Exit

Version 2.01.1204. Copyright (C) 2010 American Megatrends, Inc.
    
```

BIOS Menu 14: Chipset

PCISA-PV-D4251/N4551/D5251 CPU Card

5.4.1 Host Bridge Configuration

Use the **Host Bridge Configuration** menu (**BIOS Menu 15**) to configure the Northbridge chipset.

```

Aptio Setup Utility - Copyright (C) 2010 American Megatrends, Inc.
Chipset
> OnChip VGA Configuration
  Initiate Graphic Adapter      [IGD]
***** Memory Information *****
Memory Frequency                667 Mhz
Total Memory                    1024 MB
DIMM#0                         1024 MB
DIMM#1                         Not Present

-----
<=>: Select Screen
↑ ↓: Select Item
Enter>Select
F1   General Help
F2   Previous Values
F3   Optimized
Defaults
F4   Save
ESC  Exit

Version 2.01.1204. Copyright (C) 2010 American Megatrends, Inc.
  
```

BIOS Menu 15: Host Bridge Chipset Configuration

→ Initiate Graphics Adapter [IGD]

Use the **Initiate Graphics Adapter** option to select the graphics controller used as the primary boot device. Select either an integrated graphics controller (IGD) or a combination of PCI graphics controller, a PCI express (PEG) controller or an IGD. Configuration options are listed below:

- IGD **DEFAULT**
- PCI/IGD

5.4.1.1 OnChip VGA Configuration

Use the **OnChip VGA Configuration** menu (**BIOS Menu 15**) to configure the OnChip VGA.

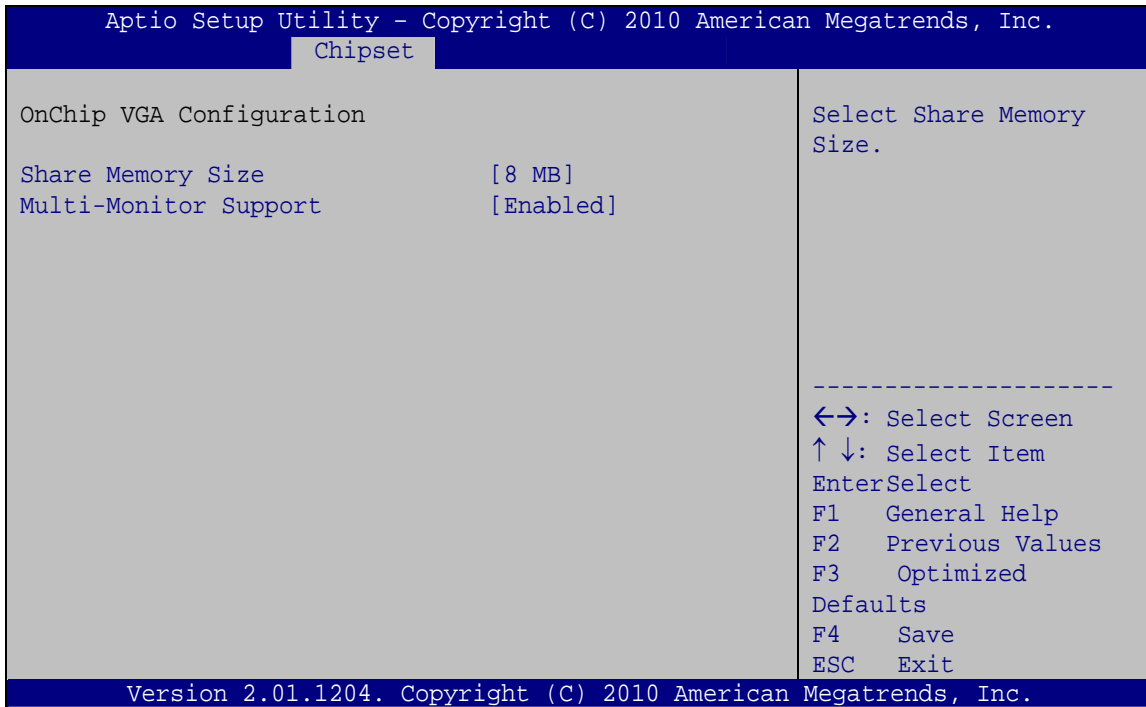

BIOS Menu 16: OnChip VGA Configuration

→ Share Memory Size [8 MB]

Use the **Share Memory Size** option to set the amount of system memory allocated to the integrated graphics processor when the system boots. The system memory allocated can then only be used as graphics memory, and is no longer available to applications or the operating system. Configuration options are listed below:

- Disabled
- 1 MB
- 8 MB **Default**

→ Multi-Monitor Support [Enabled]

Use **Multi-Monitor Support** option to enable or disable the multi-monitor function.

PCISA-PV-D4251/N4551/D5251 CPU Card

- ➔ **Disabled** Disabled the multi-monitor function
- ➔ **Enabled** **DEFAULT** Enabled the multi-monitor function

5.4.2 South Bridge Configuration

Use the **South Bridge Configuration** menu (**BIOS Menu 17**) to configure the Southbridge chipset.

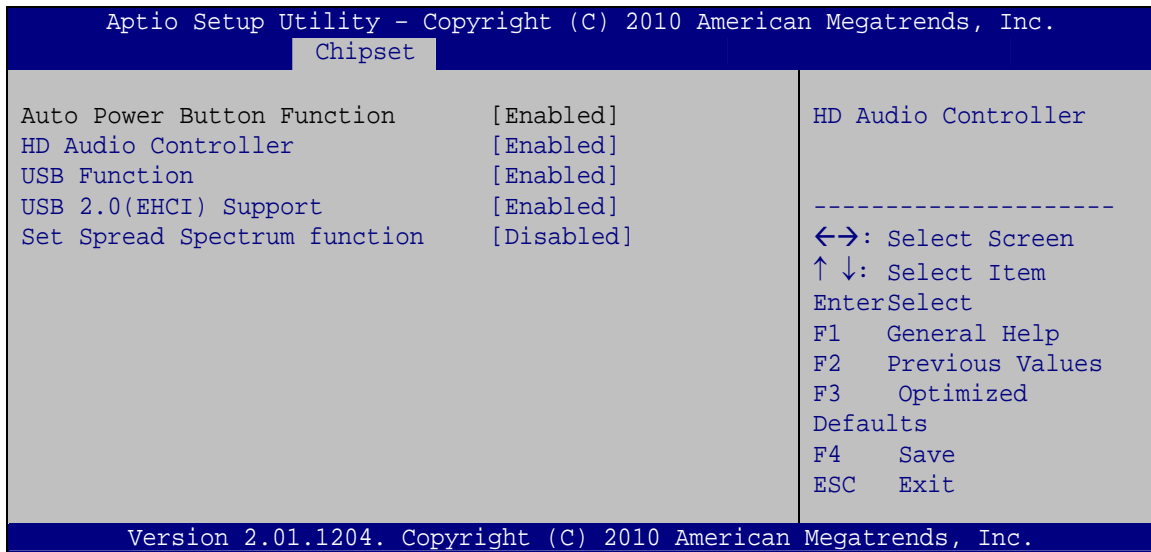

BIOS Menu 17:South Bridge Chipset Configuration

➔ **HD Audio Controller [Enabled]**

Use the **HD Audio Controller** option to enable or disable the High Definition Audio controller.

- ➔ **Enabled** **DEFAULT** The onboard High Definition Audio controller automatically detected and enabled
- ➔ **Disabled** The onboard High Definition Audio controller is disabled

➔ **USB Function [Enabled]**

Use the **USB Function** BIOS option to enable or disable USB function support.

- ➔ **Disabled** USB function support disabled

➔ Enabled DEFAULT USB function support enabled

➔ **USB 2.0 (EHCI) Support [Enabled]**

Use the **USB 2.0 (EHCI) Support** BIOS option to enable or disable USB 2.0 support.

➔ Enabled DEFAULT USB 2.0 (EHCI) support enabled

➔ Disabled USB 2.0 (EHCI) support disabled

➔ **Set Spread Spectrum Function [Disabled]**

The **Set Spread Spectrum Function** option can help to improve CPU EMI issues.

➔ Disabled DEFAULT The spread spectrum mode is disabled

➔ Enabled The spread spectrum mode is enabled

5.4.3 Intel IGD SWSCI OpRegion

Use the **Intel IGD SWSCI OpRegion** menu to configure the video device connected to the system.

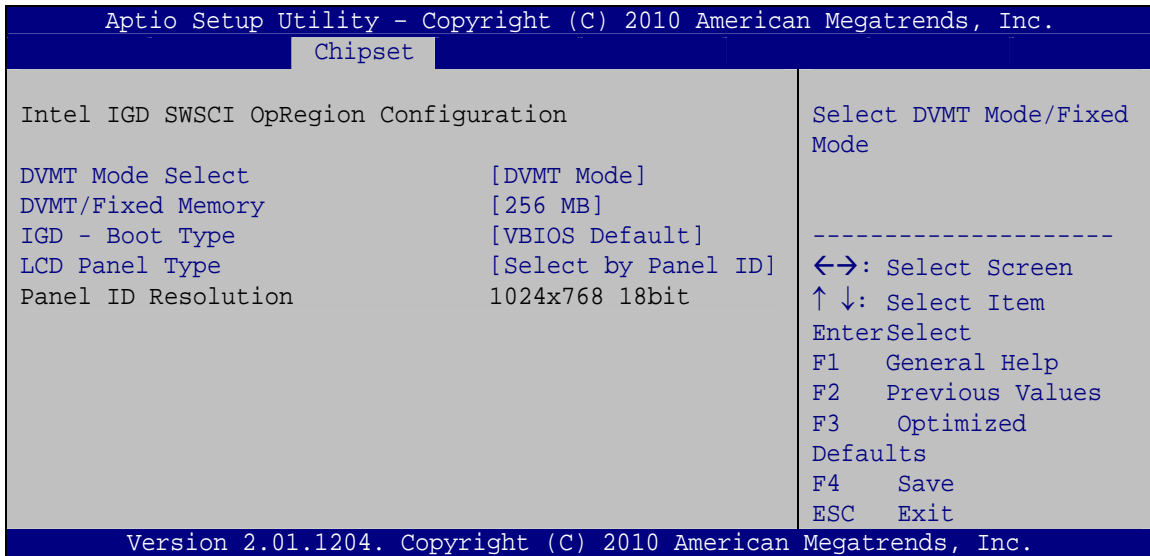

BIOS Menu 18:South Bridge Chipset Configuration

PCISA-PV-D4251/N4551/D5251 CPU Card

→ DVMT Mode Select [DVMT Mode]

Use the **DVMT Mode Select** option to select the Intel Dynamic Video Memory Technology (DVMT) operating mode.

- **Fixed Mode** A fixed portion of graphics memory is reserved as graphics memory.
- **DVMT Mode** **DEFAULT** Graphics memory is dynamically allocated according to the system and graphics needs.

→ DVMT/FIXED Memory [256 MB]

Use the **DVMT/FIXED Memory** option to specify the maximum amount of memory that can be allocated as graphics memory. Configuration options are listed below.

- 128 MB
- 256 MB **Default**
- Maximum

→ IGD - Boot Type [VBIOS Default]

Use the **IGD - Boot Type** option to select the display device used by the system when it boots. Configuration options are listed below.

- VBIOS Default **DEFAULT**
- CRT
- LFP
- CRT + LFP

→ LCD Panel Type [Select by Panel ID]

Use the **LCD Panel Type** option to select the type of flat panel connected to the system. Configuration options are listed below.

- Select by Panel ID **DEFAULT**
- 640x480 18bit
- 800x480 18bit
- 800x600 18bit

- 1024x768 18bit
- 1280x1024 18bit
- 1366x768 18bit
- 1280x800 18bit
- 1280x600 18bit

5.5 Boot

Use the **Boot** menu (**BIOS Menu 19**) to configure system boot options.

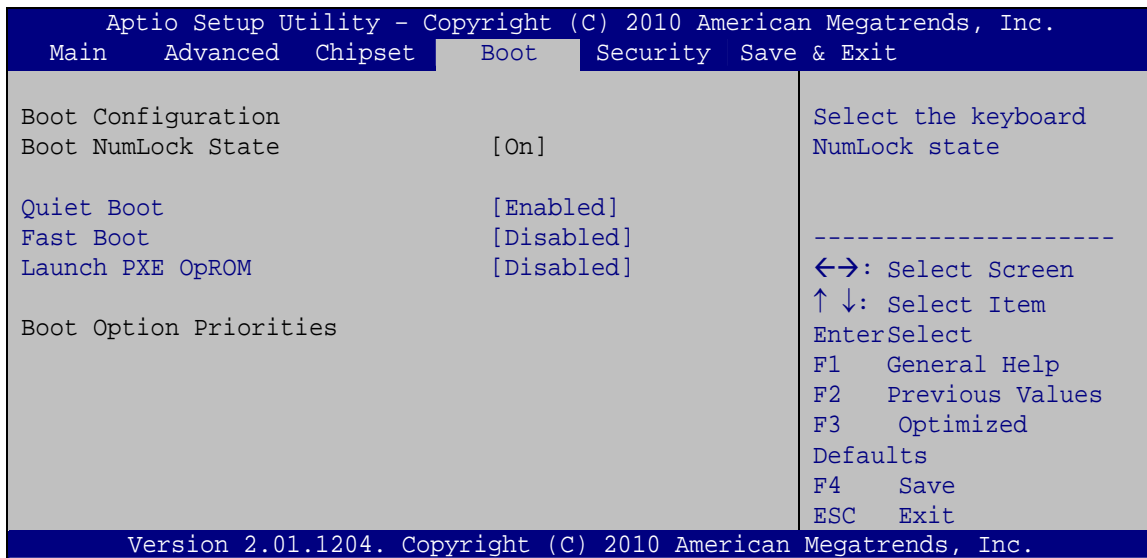

BIOS Menu 19: Boot

→ Bootup NumLock State [On]

Use the **Bootup NumLock State** BIOS option to specify if the number lock setting must be modified during boot up.

- **On** **DEFAULT** Allows the Number Lock on the keyboard to be enabled automatically when the computer system boots up. This allows the immediate use of the 10-key numeric keypad located on the right side of the keyboard. To confirm this, the Number Lock LED light on the keyboard is lit.

PCISA-PV-D4251/N4551/D5251 CPU Card

- **Off** Does not enable the keyboard Number Lock automatically. To use the 10-keys on the keyboard, press the Number Lock key located on the upper left-hand corner of the 10-key pad. The Number Lock LED on the keyboard lights up when the Number Lock is engaged.

→ **Quiet Boot [Enabled]**

Use the **Quiet Boot** BIOS option to select the screen display when the system boots.

- **Disabled** Normal POST messages displayed
- **Enabled** **DEFAULT** OEM Logo displayed instead of POST messages

→ **Fast Boot [Disabled]**

Use the **Fast Boot** option to enable or disable boot with initialization of a minimal set of devices required to launch active boot option. It has no effect for BBS boot options.

- **Disabled** **DEFAULT** Disable fast boot.
- **Enabled** Enable fast boot

→ **Launch PXE OpROM [Disabled]**

Use the **Launch PXE OpROM** option to enable or disable boot option for legacy network devices.

- **Disabled** **DEFAULT** Ignore all PXE Option ROMs
- **Enabled** Load PXE Option ROMs.

5.6 Security

Use the **Security** menu (**BIOS Menu 20**) to set system and user passwords.

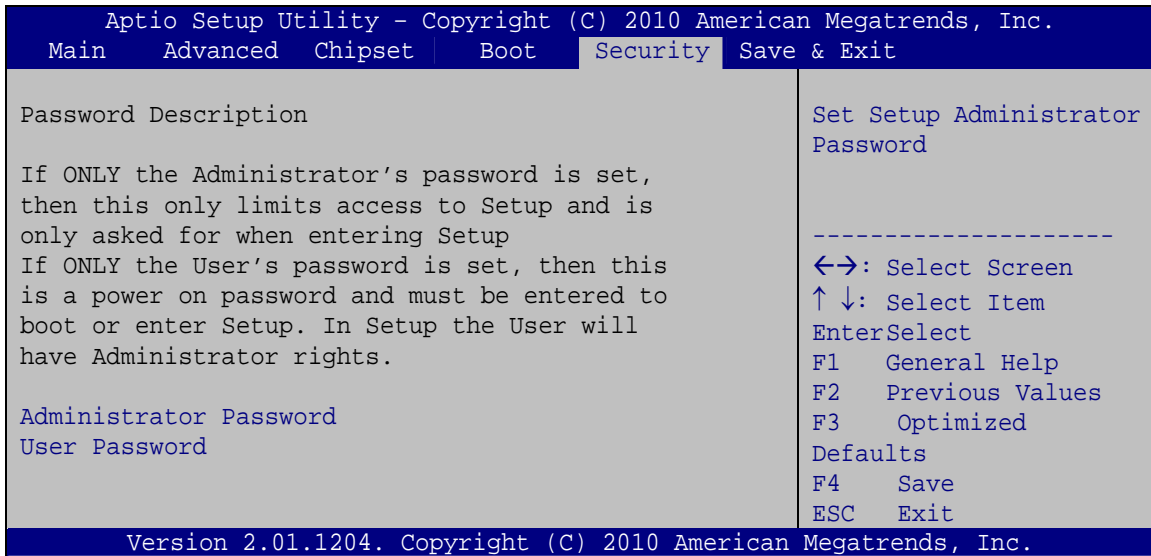

BIOS Menu 20: Security

→ Administrator Password

Use the **Administrator Password** to set or change a administrator password.

→ User Password

Use the **User Password** to set or change a user password.

PCISA-PV-D4251/N4551/D5251 CPU Card

5.7 Exit

Use the **Exit** menu (**BIOS Menu 21**) to load default BIOS values, optimal failsafe values and to save configuration changes.

```

Aptio Setup Utility - Copyright (C) 2010 American Megatrends, Inc.
Main   Advanced  Chipset  Boot   Security  Save & Exit
-----
Save Changes and Reset
Discard Changes and Reset

Restore Defaults
Save as User Defaults
Restore User Defaults

Exit system setup after
saving the changes.

-----
<-->: Select Screen
↑ ↓: Select Item
Enter>Select
F1   General Help
F2   Previous Values
F3   Optimized
Defaults
F4   Save
ESC  Exit

Version 2.01.1204. Copyright (C) 2010 American Megatrends, Inc.

```

BIOS Menu 21:Exit→ **Save Changes and Reset**

Use the **Save Changes and Reset** option to save the changes made to the BIOS options and to exit the BIOS configuration setup program.

→ **Discard Changes and Reset**

Use the **Discard Changes and Reset** option to exit the system without saving the changes made to the BIOS configuration setup program.

→ **Restore Defaults**

Use the **Restore Defaults** option to load the optimal default values for each of the parameters on the Setup menus. **F3 key can be used for this operation.**

→ **Save as User Defaults**

Use the **Save as User Defaults** option to save the changes done so far as user defaults.

→ **Restore User Defaults**

Use the **Restore User Defaults** option to restore the user defaults to all the setup options.

Appendix

A

Regulatory Compliance

DECLARATION OF CONFORMITY

This equipment has been tested and found to comply with specifications for CE marking. If the user modifies and/or installs other devices in the equipment, the CE conformity declaration may no longer apply.

FCC WARNING

This equipment complies with Part 15 of the FCC Rules. Operation is subject to the following two conditions:

- This device may not cause harmful interference, and
- This device must accept any interference received, including interference that may cause undesired operation.

This equipment has been tested and found to comply with the limits for a Class A digital device, pursuant to part 15 of the FCC Rules. These limits are designed to provide reasonable protection against harmful interference when the equipment is operated in a commercial environment. This equipment generates, uses, and can radiate radio frequency energy and, if not installed and used in accordance with the instruction manual, may cause harmful interference to radio communications. Operation of this equipment in a residential area is likely to cause harmful interference in which case the user will be required to correct the interference at his own expense.

Appendix

B

BIOS Options

Below is a list of BIOS configuration options in the BIOS chapter.

BIOS Information	60
System Date [xx/xx/xx]	60
System Time [xx:xx:xx]	61
TPM Support [Disable]	62
ATA/IDE Configurations [Enhanced]	64
Configure SATA as [IDE]	65
USB Devices	65
Legacy USB Support [Enabled]	66
Floppy Disk Controller [Enabled]	67
Serial Port [Enabled]	68
Change Settings [Auto]	68
Serial Port [Enabled]	69
Change Settings [Auto]	69
Serial Port [Enabled]	69
Change Settings [Auto]	70
Serial Port [Enabled]	70
Change Settings [Auto]	70
IrDA [Enabled]	71
Parallel Port [Enabled]	72
Change Settings [Auto]	72
Device Mode [Printer Mode]	73
PC Health Status	74
CPU Smart Fan control [Auto Mode]	75
Console Redirection [Disabled]	75
Initiate Graphics Adapter [IGD]	77
Share Memory Size [8 MB]	78
Multi-Monitor Support [Enabled]	78
HD Audio Controller [Enabled]	79
USB Function [Enabled]	79
USB 2.0 (EHCI) Support [Enabled]	80
Set Spread Spectrum Function [Disabled]	80
DVMT Mode Select [DVMT Mode]	81
DVMT/FIXED Memory [256 MB]	81

PCISA-PV-D4251/N4551/D5251 CPU Card

IGD - Boot Type [VBIOS Default]	81
LCD Panel Type [Select by Panel ID]	81
Bootup NumLock State [On]	82
Quiet Boot [Enabled]	83
Fast Boot [Disabled]	83
Launch PXE OpROM [Disabled]	83
Administrator Password	84
User Password	84
Save Changes and Reset	85
Discard Changes and Reset	85
Restore Defaults	85
Save as User Defaults	86
Restore User Defaults	86

Appendix

C

Terminology

ACPI	Advanced Configuration and Power Interface (ACPI) is an OS-directed configuration, power management, and thermal management interface.
AHCI	Advanced Host Controller Interface (AHCI) is a SATA Host controller register-level interface.
ATA	The Advanced Technology Attachment (ATA) interface connects storage devices including hard disks and CD-ROM drives to a computer.
ARMD	An ATAPI Removable Media Device (ARMD) is any ATAPI device that supports removable media, besides CD and DVD drives.
ASKIR	Amplitude Shift Keyed Infrared (ASKIR) is a form of modulation that represents a digital signal by varying the amplitude (“volume”) of the signal. A low amplitude signal represents a binary 0, while a high amplitude signal represents a binary 1.
BIOS	The Basic Input/Output System (BIOS) is firmware that is first run when the computer is turned on and can be configured by the end user
CODEC	The Compressor-Decompressor (CODEC) encodes and decodes digital audio data on the system.
CMOS	Complimentary metal-oxide-conductor is an integrated circuit used in chips like static RAM and microprocessors.
COM	COM refers to serial ports. Serial ports offer serial communication to expansion devices. The serial port on a personal computer is usually a male DB-9 connector.
DAC	The Digital-to-Analog Converter (DAC) converts digital signals to analog signals.
DDR	Double Data Rate refers to a data bus transferring data on both the rising and falling edges of the clock signal.
DMA	Direct Memory Access (DMA) enables some peripheral devices to bypass the system processor and communicate directly with the system memory.
DIMM	Dual Inline Memory Modules are a type of RAM that offer a 64-bit data bus and have separate electrical contacts on each side of the module.

DIO	The digital inputs and digital outputs are general control signals that control the on/off circuit of external devices or TTL devices. Data can be read or written to the selected address to enable the DIO functions.
EHCI	The Enhanced Host Controller Interface (EHCI) specification is a register-level interface description for USB 2.0 Host Controllers.
EIDE	Enhanced IDE (EIDE) is a newer IDE interface standard that has data transfer rates between 4.0 MBps and 16.6 MBps.
EIST	Enhanced Intel® SpeedStep Technology (EIST) allows users to modify the power consumption levels and processor performance through application software. The application software changes the bus-to-core frequency ratio and the processor core voltage.
GbE	Gigabit Ethernet (GbE) is an Ethernet version that transfers data at 1.0 Gbps and complies with the IEEE 802.3-2005 standard.
GPIO	General purpose input
HDD	Hard disk drive (HDD) is a type of magnetic, non-volatile computer storage device that stores digitally encoded data.
ICH	The Input/Output Control Hub (ICH) is an Intel® Southbridge chipset.
IrDA	Infrared Data Association (IrDA) specify infrared data transmission protocols used to enable electronic devices to wirelessly communicate with each other.
L1 Cache	The Level 1 Cache (L1 Cache) is a small memory cache built into the system processor.
L2 Cache	The Level 2 Cache (L2 Cache) is an external processor memory cache.
LCD	Liquid crystal display (LCD) is a flat, low-power display device that consists of two polarizing plates with a liquid crystal panel in between.
LVDS	Low-voltage differential signaling (LVDS) is a dual-wire, high-speed differential electrical signaling system commonly used to connect LCD displays to a computer.
POST	The Power-on Self Test (POST) is the pre-boot actions the system performs when the system is turned-on.

PCISA-PV-D4251/N4551/D5251 CPU Card

RAM	Random Access Memory (RAM) is volatile memory that loses data when power is lost. RAM has very fast data transfer rates compared to other storage like hard drives.
SATA	Serial ATA (SATA) is a serial communications bus designed for data transfers between storage devices and the computer chipsets. The SATA bus has transfer speeds up to 1.5 Gbps and the SATA II bus has data transfer speeds of up to 3.0 Gbps.
S.M.A.R.T	Self Monitoring Analysis and Reporting Technology (S.M.A.R.T) refers to automatic status checking technology implemented on hard disk drives.
UART	Universal Asynchronous Receiver-transmitter (UART) is responsible for asynchronous communications on the system and manages the system's serial communication (COM) ports.
UHCI	The Universal Host Controller Interface (UHCI) specification is a register-level interface description for USB 1.1 Host Controllers.
USB	The Universal Serial Bus (USB) is an external bus standard for interfacing devices. USB 1.1 supports 12Mbps data transfer rates and USB 2.0 supports 480Mbps data transfer rates.
VGA	The Video Graphics Array (VGA) is a graphics display system developed by IBM.

Appendix

D

Watchdog Timer

**NOTE:**

The following discussion applies to DOS. Contact IEI support or visit the IEI website for drivers for other operating systems.

The Watchdog Timer is a hardware-based timer that attempts to restart the system when it stops working. The system may stop working because of external EMI or software bugs. The Watchdog Timer ensures that standalone systems like ATMs will automatically attempt to restart in the case of system problems.

A BIOS function call (INT 15H) is used to control the Watchdog Timer.

INT 15H:

AH – 6FH Sub-function:	
AL – 2:	Sets the Watchdog Timer's period.
BL:	Time-out value (Its unit-second is dependent on the item "Watchdog Timer unit select" in CMOS setup).

Table D-1: AH-6FH Sub-function

Call sub-function 2 to set the time-out period of Watchdog Timer first. If the time-out value is not zero, the Watchdog Timer starts counting down. When the timer value reaches zero, the system resets. To ensure that this reset condition does not occur, calling sub-function 2 must periodically refresh the Watchdog Timer. However, the watchdog timer is disabled if the time-out value is set to zero.

A tolerance of at least 10% must be maintained to avoid unknown routines within the operating system (DOS), such as disk I/O that can be very time-consuming.

**NOTE:**

The Watchdog Timer is activated through software. The software application that activates the Watchdog Timer must also deactivate it when closed. If the Watchdog Timer is not deactivated, the system will automatically restart after the Timer has finished its countdown.

EXAMPLE PROGRAM:

```
; INITIAL TIMER PERIOD COUNTER
```

```
;
```

```
W_LOOP:
```

```
;
```

```
    MOV    AX, 6F02H    ;setting the time-out value  
    MOV    BL, 30      ;time-out value is 48 seconds  
    INT    15H
```

```
;
```

```
; ADD THE APPLICATION PROGRAM HERE
```

```
;
```

```
    CMP    EXIT_AP, 1    ;is the application over?  
    JNE    W_LOOP      ;No, restart the application  
    MOV    AX, 6F02H    ;disable Watchdog Timer  
    MOV    BL, 0        ;  
    INT    15H
```

```
;
```

```
; EXIT ;
```

Appendix

E

Digital I/O Interface

E.1 Introduction

The digital I/O is used for machine control and automation.

E.2 DIO Connector Pinouts

Located in the Connectors section of this document.

E.3 Assembly Language Example

```

;*****
; DIO Port:  0A21h[3:0] (4 Out)
;            0A22h[3:0] (4 In)
;*****

;=====
; Get current input and output values into AL register
; AL: bit0~bit3 as output value
;     bit4~bit7 as Input value
;=====

        mov     dx, 0A21h      ; GPIO output I/O base address
        in      al, dx         ; Get output status
        jmp     $+2           ; Wait
        jmp     $+2           ; Wait
        and     al, 0Fh
        mov     bl, al        ; Move al to bl temporarily

        inc     dx            ; sets dx to 0A22h
        in      al, dx         ; Get input status
        jmp     $+2           ; Wait
        jmp     $+2           ; Wait
        and     al, 0Fh
        rol     al, 4          ; Shift input values over
        or      al, bl        ; Merge all results into AL
                                ; AL: bit0~bit3 as output value
                                ;     bit4~bit7 as input value

;=====
; Output value (x) to GPIO
; AL: bit0~bit3 as output value
;=====

        mov     al, 0xh       ; x is the output value (0 ~ Fh)
        mov     dx, 0A21h     ; GPIO output I/O base address
        out     dx, al        ; bit0 ~ bit3 as Output value
                                ; bit4 ~ bit7 are Reserved

```

Appendix

F

Hazardous Materials Disclosure

F.1 Hazardous Materials Disclosure Table for IPB Products Certified as RoHS Compliant Under 2002/95/EC Without Mercury

The details provided in this appendix are to ensure that the product is compliant with the Peoples Republic of China (China) RoHS standards. The table below acknowledges the presences of small quantities of certain materials in the product, and is applicable to China RoHS only.

A label will be placed on each product to indicate the estimated “Environmentally Friendly Use Period” (EFUP). This is an estimate of the number of years that these substances would “not leak out or undergo abrupt change.” This product may contain replaceable sub-assemblies/components which have a shorter EFUP such as batteries and lamps. These components will be separately marked.

Please refer to the table on the next page.

PCISA-PV-D4251/N4551/D5251 CPU Card

Part Name	Toxic or Hazardous Substances and Elements					
	Lead (Pb)	Mercury (Hg)	Cadmium (Cd)	Hexavalent Chromium (CR(VI))	Polybrominated Biphenyls (PBB)	Polybrominated Diphenyl Ethers (PBDE)
Housing	<input type="radio"/>	<input type="radio"/>	<input type="radio"/>	<input type="radio"/>	<input type="radio"/>	<input type="radio"/>
Display	<input type="radio"/>	<input type="radio"/>	<input type="radio"/>	<input type="radio"/>	<input type="radio"/>	<input type="radio"/>
Printed Circuit Board	<input type="radio"/>	<input type="radio"/>	<input type="radio"/>	<input type="radio"/>	<input type="radio"/>	<input type="radio"/>
Metal Fasteners	<input type="radio"/>	<input type="radio"/>	<input type="radio"/>	<input type="radio"/>	<input type="radio"/>	<input type="radio"/>
Cable Assembly	<input type="radio"/>	<input type="radio"/>	<input type="radio"/>	<input type="radio"/>	<input type="radio"/>	<input type="radio"/>
Fan Assembly	<input type="radio"/>	<input type="radio"/>	<input type="radio"/>	<input type="radio"/>	<input type="radio"/>	<input type="radio"/>
Power Supply Assemblies	<input type="radio"/>	<input type="radio"/>	<input type="radio"/>	<input type="radio"/>	<input type="radio"/>	<input type="radio"/>
Battery	<input type="radio"/>	<input type="radio"/>	<input type="radio"/>	<input type="radio"/>	<input type="radio"/>	<input type="radio"/>

O: This toxic or hazardous substance is contained in all of the homogeneous materials for the part is below the limit requirement in SJ/T11363-2006

X: This toxic or hazardous substance is contained in at least one of the homogeneous materials for this part is above the limit requirement in SJ/T11363-2006

此附件旨在确保本产品符合中国 RoHS 标准。以下表格标示此产品中某有毒物质的含量符合中国 RoHS 标准规定的限量要求。

本产品上会附有“环境友好使用期限”的标签，此期限是估算这些物质“不会有泄漏或突变”的年限。本产品可能包含有较短的环境友好使用期限的可替换元件，像是电池或灯管，这些元件将会单独标示出来。

部件名称	有毒有害物质或元素					
	铅 (Pb)	汞 (Hg)	镉 (Cd)	六价铬 (CR(VI))	多溴联苯 (PBB)	多溴二苯 醚 (PBDE)
壳体	○	○	○	○	○	○
显示	○	○	○	○	○	○
印刷电路板	○	○	○	○	○	○
金属螺帽	○	○	○	○	○	○
电缆组装	○	○	○	○	○	○
风扇组装	○	○	○	○	○	○
电力供应组装	○	○	○	○	○	○
电池	○	○	○	○	○	○

○: 表示该有毒有害物质在该部件所有物质材料中的含量均在 SJ/T11363-2006 标准规定的限量要求以下。
 X: 表示该有毒有害物质至少在该部件的某一均质材料中的含量超出 SJ/T11363-2006 标准规定的限量要求。