



MODEL:
UPC-V315-QM77

Panel PC with Touch Screen and Intel® Core™ i3-3217UE/
i7-3517UE Processor, GbE, Wireless, USB, Audio,
RS-232/422/485, RoHS Compliant, IP 65 Protection

User Manual

Revision

| Date | Version | Changes |
|------------------|---------|-----------------------------|
| 9 February, 2015 | 1.01 | Update P.N of Power adapter |
| 4 July, 2014 | 1.00 | Initial release |

Copyright

COPYRIGHT NOTICE

The information in this document is subject to change without prior notice in order to improve reliability, design and function and does not represent a commitment on the part of the manufacturer.

In no event will the manufacturer be liable for direct, indirect, special, incidental, or consequential damages arising out of the use or inability to use the product or documentation, even if advised of the possibility of such damages.

This document contains proprietary information protected by copyright. All rights are reserved. No part of this manual may be reproduced by any mechanical, electronic, or other means in any form without prior written permission of the manufacturer.

TRADEMARKS

All registered trademarks and product names mentioned herein are used for identification purposes only and may be trademarks and/or registered trademarks of their respective owners.

Table of Contents

| | |
|--|-----------|
| 1 INTRODUCTION..... | 1 |
| 1.1 OVERVIEW..... | 2 |
| 1.2 MODEL VARIATIONS | 3 |
| 1.3 FEATURES..... | 3 |
| 1.4 EXTERNAL OVERVIEW | 3 |
| 1.4.1 <i>Front Panel</i> | 3 |
| 1.4.1.1 LED Indicators..... | 4 |
| 1.4.2 <i>Bottom Panel</i> | 6 |
| 1.4.3 <i>Side Panels</i> | 7 |
| 1.4.4 <i>Rear Panel</i> | 8 |
| 1.4.5 <i>Frame (Function Keys)</i> | 8 |
| 1.5 DIMENSIONS..... | 10 |
| 1.6 SPECIFICATIONS | 11 |
| 2 UNPACKING | 14 |
| 2.1 UNPACKING..... | 15 |
| 2.2 PACKING LIST..... | 16 |
| 3 INSTALLATION | 18 |
| 3.1 ANTI-STATIC PRECAUTIONS | 19 |
| 3.2 INSTALLATION PRECAUTIONS | 19 |
| 3.3 PREINSTALLED COMPONENTS..... | 20 |
| 3.4 SSD INSTALLATION | 20 |
| 3.5 MOUNTING THE SYSTEM | 23 |
| 3.5.1 <i>Wall Mounting</i> | 24 |
| 3.6 BOTTOM PANEL CONNECTORS..... | 27 |
| 3.6.1 <i>External Peripheral Device Connection</i> | 27 |
| 3.6.2 <i>ACC Mode Selection</i> | 29 |
| 3.6.3 <i>AT/ATX Power Mode Selection</i> | 29 |
| 3.6.4 <i>Audio Connectors</i> | 30 |
| 3.6.5 <i>CAN-bus Terminal Block</i> | 30 |

UPC-V315-QM77 Panel PC

| | | |
|----------|--|-----------|
| 3.6.6 | HDMI Connector | 30 |
| 3.6.7 | LAN Connector | 32 |
| 3.6.8 | Power Input, 3-pin Terminal Block..... | 33 |
| 3.6.9 | Power Input, 4-pin DIN Connector | 33 |
| 3.6.10 | RJ-45 RS-232 Serial Port..... | 34 |
| 3.6.11 | RJ-45 RS-422/485 Serial Port..... | 36 |
| 3.6.12 | USB Connectors..... | 37 |
| 3.6.13 | VGA Connector | 39 |
| 3.7 | REDUNDANT POWER | 41 |
| 3.7.1 | ACC ON | 42 |
| 3.7.1.1 | Boot-up | 42 |
| 3.7.1.2 | Switch to Backup Power..... | 43 |
| 3.7.1.3 | Shutdown | 43 |
| 3.7.2 | ACC OFF | 44 |
| 3.7.2.1 | Boot-up | 44 |
| 3.7.2.2 | Switch to Backup Power..... | 45 |
| 3.7.2.3 | Shutdown | 46 |
| 3.8 | REMOTE CONTROL..... | 47 |
| 4 | BIOS..... | 48 |
| 4.1 | INTRODUCTION..... | 49 |
| 4.1.1 | Starting Setup..... | 49 |
| 4.1.2 | Using Setup | 49 |
| 4.1.3 | Getting Help..... | 50 |
| 4.1.4 | Unable to Reboot after Configuration Changes | 50 |
| 4.1.5 | BIOS Menu Bar..... | 50 |
| 4.2 | MAIN..... | 51 |
| 4.3 | ADVANCED..... | 52 |
| 4.3.1 | ACPI Settings..... | 53 |
| 4.3.2 | RTC Wake Settings | 54 |
| 4.3.3 | CPU Configuration..... | 55 |
| 4.3.4 | SATA Configuration | 57 |
| 4.3.5 | Intel(R) Rapid Start Technology | 57 |
| 4.3.6 | USB Configuration..... | 58 |
| 4.3.7 | F81866 Super IO Configuration..... | 59 |

| | |
|---|-----------|
| 4.3.7.1 Serial Port n Configuration | 60 |
| 4.3.8 H/W Monitor | 63 |
| 4.3.9 Serial Port Console Redirection | 64 |
| 4.3.10 iEi Feature | 66 |
| 4.4 CHIPSET | 68 |
| 4.4.1 PCH-IO Configuration | 69 |
| 4.4.1.1 PCH Azalia Configuration | 70 |
| 4.4.2 System Agent (SA) Configuration | 71 |
| 4.4.2.1 Graphics Configuration..... | 71 |
| 4.4.2.2 NB PCIe Configuration..... | 74 |
| 4.4.2.3 Memory Configuration | 75 |
| 4.5 BOOT..... | 76 |
| 4.6 SECURITY..... | 78 |
| 4.7 SAVE & EXIT | 79 |
| A BIOS MENU OPTIONS | 81 |
| B ONE KEY RECOVERY | 84 |
| B.1 ONE KEY RECOVERY INTRODUCTION | 85 |
| B.1.1 System Requirement..... | 86 |
| B.1.2 Supported Operating System | 87 |
| B.2 SETUP PROCEDURE FOR WINDOWS | 88 |
| B.2.1 Hardware and BIOS Setup | 89 |
| B.2.2 Create Partitions | 89 |
| B.2.3 Install Operating System, Drivers and Applications..... | 93 |
| B.2.4 Building the Recovery Partition | 94 |
| B.2.5 Create Factory Default Image..... | 96 |
| B.3 AUTO RECOVERY SETUP PROCEDURE..... | 101 |
| B.4 SETUP PROCEDURE FOR LINUX | 105 |
| B.5 RECOVERY TOOL FUNCTIONS | 109 |
| B.5.1 Factory Restore | 110 |
| B.5.2 Backup System..... | 111 |
| B.5.3 Restore Your Last Backup..... | 112 |
| B.5.4 Manual..... | 113 |
| B.6 RESTORE SYSTEMS FROM A LINUX SERVER THROUGH LAN | 114 |
| B.6.1 Configure DHCP Server Settings | 115 |

UPC-V315-QM77 Panel PC

| | |
|--|------------|
| <i>B.6.2 Configure TFTP Settings</i> | 116 |
| <i>B.6.3 Configure One Key Recovery Server Settings</i> | 117 |
| <i>B.6.4 Start the DHCP, TFTP and HTTP</i> | 118 |
| <i>B.6.5 Create Shared Directory</i> | 118 |
| <i>B.6.6 Setup a Client System for Auto Recovery</i> | 119 |
| B.7 OTHER INFORMATION | 122 |
| <i>B.7.1 Using AHCI Mode or ALi M5283 / VIA VT6421A Controller</i> | 122 |
| <i>B.7.2 System Memory Requirement</i> | 124 |
| C SAFETY PRECAUTIONS | 125 |
| C.1 SAFETY PRECAUTIONS | 126 |
| <i>C.1.1 General Safety Precautions</i> | 126 |
| <i>C.1.2 Anti-static Precautions</i> | 127 |
| <i>C.1.3 Product Disposal</i> | 127 |
| C.2 MAINTENANCE AND CLEANING PRECAUTIONS | 128 |
| <i>C.2.1 Maintenance and Cleaning</i> | 128 |
| <i>C.2.2 Cleaning Tools</i> | 129 |
| D HAZARDOUS MATERIALS DISCLOSURE | 130 |
| D.1 HAZARDOUS MATERIAL DISCLOSURE TABLE FOR IPB PRODUCTS CERTIFIED AS ROHS COMPLIANT UNDER 2002/95/EC WITHOUT MERCURY | 131 |

List of Figures

| | |
|---|----|
| Figure 1-1: UPC-V315-QM77 Panel PC | 2 |
| Figure 1-2: Front View | 4 |
| Figure 1-3: LED Indicators | 5 |
| Figure 1-4: Bottom View | 7 |
| Figure 1-5: Left Side View | 7 |
| Figure 1-6: Right Side View | 8 |
| Figure 1-7: Rear View | 8 |
| Figure 1-8: Function Key Locations | 9 |
| Figure 1-9: UPC-V315-QM77 Dimensions (mm)..... | 10 |
| Figure 3-1: Remove the SSD Drive Bay Access Panel | 21 |
| Figure 3-2: Inserting the SSD | 21 |
| Figure 3-3: Securing the SSD | 22 |
| Figure 3-4: SSD Installation..... | 22 |
| Figure 3-5: VESA Mount Retention Screw Holes | 23 |
| Figure 3-6: Mounting Brackets (Side Panels)..... | 24 |
| Figure 3-7: Wall-mounting Bracket | 25 |
| Figure 3-8: Chassis Support Screws | 26 |
| Figure 3-9: Secure the Panel PC | 27 |
| Figure 3-10: I/O Cover Retention Screws | 28 |
| Figure 3-11: External Peripheral Device Connection..... | 28 |
| Figure 3-12: Rubber Gasket Removal..... | 28 |
| Figure 3-13: Rubber Gasket and Cable | 29 |
| Figure 3-14: External Peripheral Device Connection Complete | 29 |
| Figure 3-15: ACC Mode Switch | 29 |
| Figure 3-16: AT/ATX Power Mode Switch | 30 |
| Figure 3-17: CAN-bus Terminal Block Pinouts..... | 30 |
| Figure 3-18: HDMI Connection | 31 |
| Figure 3-19: LAN Connection | 32 |
| Figure 3-20: RJ-45 Ethernet Connector..... | 32 |
| Figure 3-21: 3-pin Terminal Block Pinouts | 33 |
| Figure 3-22: Power Input Connector..... | 34 |

UPC-V315-QM77 Panel PC

| | |
|--|----|
| Figure 3-23: RJ-45 RS-232 Serial Port Pinout Location | 34 |
| Figure 3-24: DB-9 Connector Pinout Location | 34 |
| Figure 3-25: RJ-45 RS-232 Serial Device Connection..... | 35 |
| Figure 3-26: RJ-45 RS-422/485 Serial Port Pinout Location..... | 36 |
| Figure 3-27: DB-9 Connector Pinout Location | 36 |
| Figure 3-28: RJ-45 RS-422/485 Serial Device Connection..... | 37 |
| Figure 3-29: USB Device Connection | 38 |
| Figure 3-30: VGA Connector | 39 |
| Figure 3-31: VGA Connector | 40 |
| Figure 3-32: Power Connectors | 41 |
| Figure 3-33: ACC On: AT Mode | 42 |
| Figure 3-34: ACC On: ATX Mode..... | 42 |
| Figure 3-35: ACC On: Switch Between PWR1 and PWR2 | 43 |
| Figure 3-36: ACC On: Shutdown..... | 44 |
| Figure 3-37: ACC Off: AT Mode..... | 45 |
| Figure 3-38: ACC Off: ATX Mode | 45 |
| Figure 3-39: ACC Off: Switch Between PWR1 and PWR2 | 45 |
| Figure 3-40: ACC Off: Shutdown..... | 46 |
| Figure 3-41: Remote Control | 47 |
| Figure B-1: IEI One Key Recovery Tool Menu | 85 |
| Figure B-2: Launching the Recovery Tool | 90 |
| Figure B-3: Recovery Tool Setup Menu | 90 |
| Figure B-4: Command Prompt | 91 |
| Figure B-5: Partition Creation Commands..... | 92 |
| Figure B-6: Launching the Recovery Tool | 94 |
| Figure B-7: Manual Recovery Environment for Windows | 94 |
| Figure B-8: Building the Recovery Partition..... | 95 |
| Figure B-9: Press Any Key to Continue | 95 |
| Figure B-10: Press F3 to Boot into Recovery Mode..... | 96 |
| Figure B-11: Recovery Tool Menu | 96 |
| Figure B-12: About Symantec Ghost Window..... | 97 |
| Figure B-13: Symantec Ghost Path | 97 |
| Figure B-14: Select a Local Source Drive | 98 |
| Figure B-15: Select a Source Partition from Basic Drive | 98 |
| Figure B-16: File Name to Copy Image to | 99 |

| | |
|--|-----|
| Figure B-17: Compress Image..... | 99 |
| Figure B-18: Image Creation Confirmation | 100 |
| Figure B-19: Image Creation Complete | 100 |
| Figure B-20: Image Creation Complete | 100 |
| Figure B-21: Press Any Key to Continue | 101 |
| Figure B-22: Auto Recovery Utility | 102 |
| Figure B-23: Launching the Recovery Tool | 102 |
| Figure B-24: Auto Recovery Environment for Windows | 102 |
| Figure B-25: Building the Auto Recovery Partition..... | 103 |
| Figure B-26: Factory Default Image Confirmation | 103 |
| Figure B-27: Image Creation Complete | 104 |
| Figure B-28: Press any key to continue | 104 |
| Figure B-29: Partitions for Linux..... | 106 |
| Figure B-30: Manual Recovery Environment for Linux | 107 |
| Figure B-31: Access menu.lst in Linux (Text Mode)..... | 108 |
| Figure B-32: Recovery Tool Menu | 108 |
| Figure B-33: Recovery Tool Main Menu | 109 |
| Figure B-34: Restore Factory Default | 110 |
| Figure B-35: Recovery Complete Window | 111 |
| Figure B-36: Backup System..... | 111 |
| Figure B-37: System Backup Complete Window | 112 |
| Figure B-38: Restore Backup | 112 |
| Figure B-39: Restore System Backup Complete Window | 113 |
| Figure B-40: Symantec Ghost Window | 113 |

List of Tables

| | |
|--|-----------|
| Table 1-1: LED Indicators | 6 |
| Table 1-2: Function Keys | 9 |
| Table 1-3: System Specifications..... | 13 |
| Table 3-1: HDMI Pinouts | 31 |
| Table 3-2: LAN Pinouts | 33 |
| Table 3-3: RJ-45 Ethernet Connector LEDs | 33 |
| Table 3-4: RJ-45 RS-232 Serial Port Pinouts | 34 |
| Table 3-5: DB-9 Connector Pinouts | 35 |
| Table 3-6: RJ-45 RS-422/485 Serial Port Pinouts | 36 |
| Table 3-7: DB-9 Connector Pinouts | 36 |
| Table 3-8: USB Port Pinouts (USB 2.0)..... | 38 |
| Table 3-9: USB Port Pinouts (USB 3.0)..... | 39 |
| Table 3-10: VGA Connector Pinouts..... | 39 |
| Table 4-1: BIOS Navigation Keys | 50 |

Chapter

1

Introduction

1.1 Overview



Figure 1-1: UPC-V315-QM77 Panel PC

The fanless UPC-V315-QM77 is Intel® Core™ i3-3217UE/i7-3517UE processor powered panel PC with a rich variety of functions and peripherals. The UPC-V315-QM77 panel PC is designed for easy and simplified integration into various vehicle applications.

An Intel® mobile QM77 express chipset ensures optimal memory, graphics, and peripheral I/O support. The system comes with 2GB of preinstalled DDR3 SDRAM ensuring smooth data throughputs with reduced bottlenecks and fast system access.

The redundant dual DC power input of the UPC-V315-QM77 increases the reliability of the system and prevents data loss and system corruption from sudden power failure.

The CAN-bus interface allows the UPC-V315-QM77 to communication with vehicles. Four serial ports, two external USB 3.0 ports and two external USB 2.0 ports ensure simplified connectivity to a variety of external peripheral devices. Wi-Fi capabilities and dual RJ-45 GbE connectors ensure smooth connection of the system to an external LAN.

UPC-V315-QM77 Panel PC

1.2 Model Variations

The model numbers and model variations are listed below.

| Model | CPU |
|---------------------------|----------------------------------|
| UPC-V315-QM77-i7/R/2G-R10 | Intel® Core™ i7-3517UE Processor |
| UPC-V315-QM77-i3/R/2G-R10 | Intel® Core™ i3-3217UE Processor |

1.3 Features

All the UPC-V315-QM77 models feature the following:

- Intel Ivy Bridge mobile chipset (QM77)
- 15" 400 nits 1024 x 768 LCD with LED backlight
- Full IP 65 compliant die-casting aluminum chassis
- PCIe mini card expansion
- Dual-DC input, 9V ~ 36V and 10.5V ~ 36V, switch automatically
- ACC power support
- Dual-band 2.4/5GHz Wi-Fi 802.11 a/b/g/n 3T3R MIMO design
- Reserved space for 3.75G / HSUPA USB dongle
- Built-in 2M pixels webcam with AF, AE and AWB capabilities
- CAN-bus interface with isolation
- F1 ~ F10 function keys with customization options

1.4 External Overview

The panel PC is a rectangular cubic structure that comprises of a screen, rear panel, top panel, bottom panel and two side panels (left and right). An aluminum frame surrounds the front screen. The rear panel provides screw holes for a wall-mounting bracket, and an arm mounting interface. The bottom panel provides access to external interface connectors.

1.4.1 Front Panel

The front side of the UPC-V315-QM77 is a flat panel TFT LCD screen surrounded by an aluminum frame. At the top of the front panel features one 2.0 megapixel webcam that

supports auto-focus (AF), auto-exposure (AE) and auto white balance (AWB). The front panel also has following buttons, LED indicators and sensors:

- Buttons: F1~F10 (same as the function key on the keyboard)
- LEDs
 - Power 1 LED
 - Power 2 LED
 - AT/ATX power mode LED
 - CPU temperature alert LED
 - Wi-Fi connection LED
 - Auto dimming LED
 - Microphone on/off LED
 - Audio mute LED
- Sensors
 - Ambient light sensor
 - Infrared remote control sensor

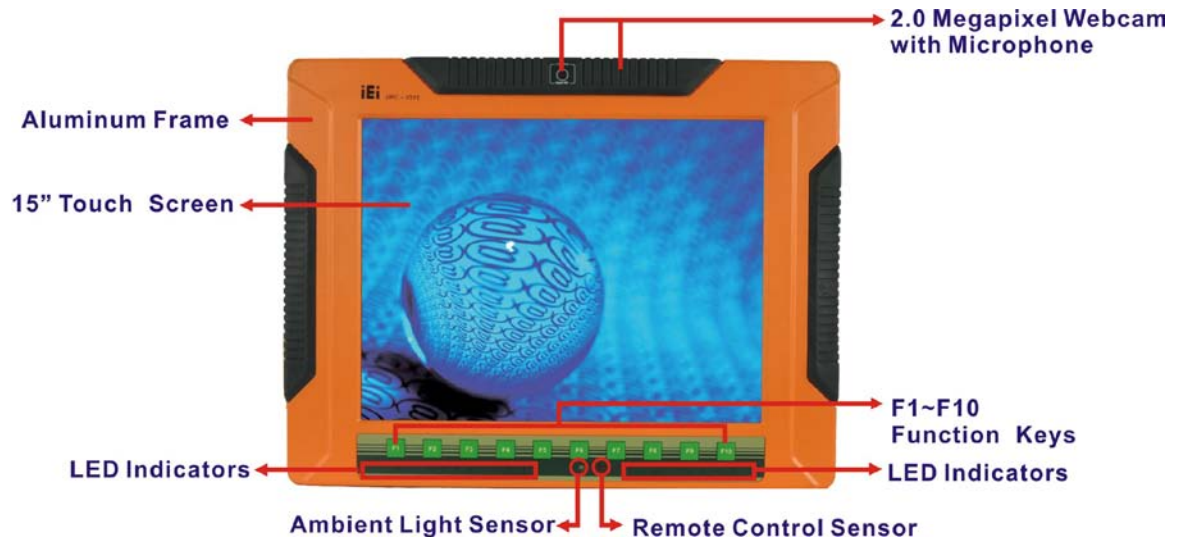

Figure 1-2: Front View

1.4.1.1 LED Indicators

The LED indicators on the front panel of the UPC-V315-QM77 are shown below.



Figure 1-3: LED Indicators

The descriptions of each LED indicator are listed below.

| LED Indicator | Description |
|------------------------------|--|
| Power 1 | Pulsing Orange: Power 1 is the main power and is in standby mode Solid Orange: Power 1 is the second power and is in standby mode Solid Blue: Power 1 is providing power to the system |
| Power 2 | Pulsing Orange: Power 2 is the main power and is in standby mode Solid Orange: Power 2 is the second power and is in standby mode Solid Blue: Power 2 is providing power to the system |
| AT/ATX Power Mode | Shows the power mode status. Controlled by the AT/ATX power mode switch. |
| CPU Temperature Alert | Blue: the CPU temperature is normal. Red: the CPU temperature is too high. |
| Wi-Fi | The Wi-Fi module is enabled or disabled. Controlled by the BIOS (see Section 4.4.1). |
| Auto Dimming | The auto dimming function is enabled or disabled. Controlled by the BIOS (4.4.1). |
| Microphone | The microphone is enabled or disabled. Controlled by the BIOS (Section 4.4.1). |
| Audio Mute | Light on when the audio is turned off. Controlled by the hot keys (see Section 1.4.5). |
| Function | Shows the status of the function key below the LED indicator. Blinks when the corresponding button is pushed. |
| LCD on/off | |

| | |
|-----------------|--|
| Volume Down | |
| Volume Up | |
| Brightness Down | |
| Brightness Up | |

Table 1-1: LED Indicators



CAUTION:

If the CPU temperature alert LED shows in red, the user must lower the environment temperature or close some running applications to cool down the CPU.

1.4.2 Bottom Panel

The following is a list of the bottom panel peripheral device connectors on the UPC-V315-QM77.

- 1 x 9 V ~ 36 V DC power input terminal block (Power I)
- 1 x 10.5 V ~ 36 V DC power input connector (Power II)
- 2 x Audio jacks (Line out ,MIC)
- 1 x CAN bus connector
- 1 x HDMI connector
- 2 x RJ-45 GbE connectors
- 3 x RS-232 serial port connectors by RJ-45
- 1 x RS-422/485 serial port connector by RJ-45
- 2 x USB 2.0 connectors
- 2 x USB 3.0 connectors
- 1 x VGA connector

The bottom panel also includes the following switches and buttons:

UPC-V315-QM77 Panel PC

- 1 x ACC on/off switch
- 1 x AT/ATX power mode switch
- 1 x Clear CMOS switch
- 1 x Reset button

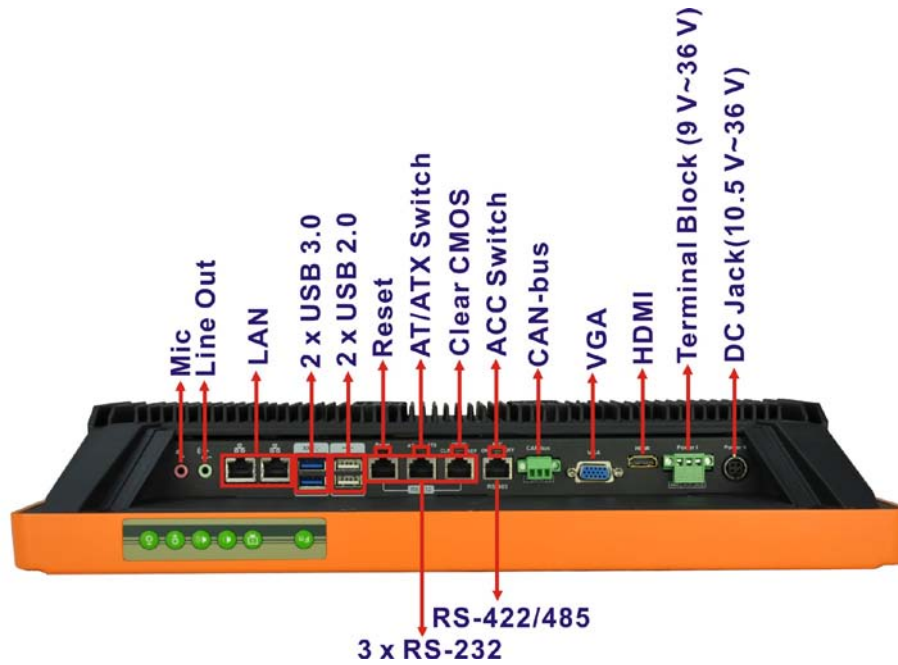

Figure 1-4: Bottom View

1.4.3 Side Panels

The left side panel of the panel PC provides access to the SSD drive bay. (Figure 1-5)



Figure 1-5: Left Side View



Figure 1-6: Right Side View

1.4.4 Rear Panel

The rear panel has retention screw holes that support a wall-mounting bracket.

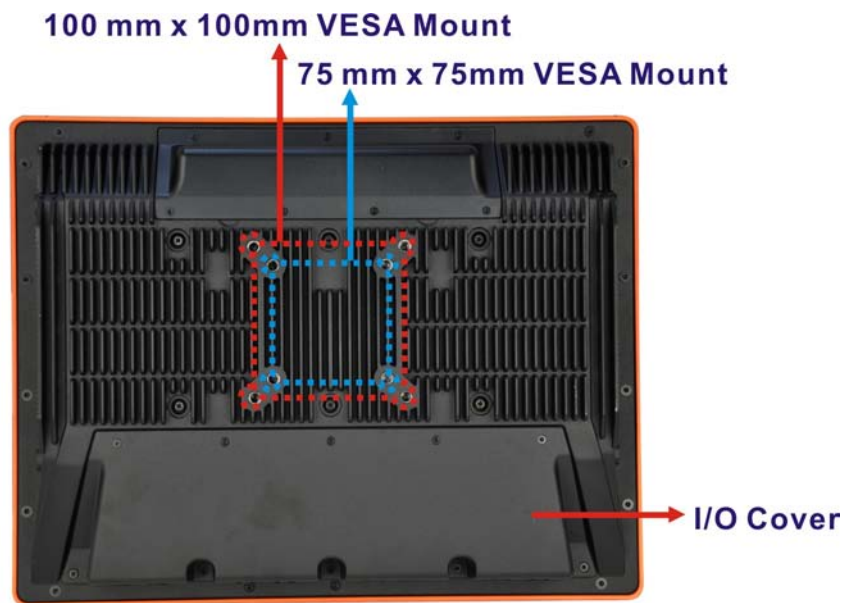

Figure 1-7: Rear View

1.4.5 Frame (Function Keys)

An aluminum frame surrounds the TFT LCD screen. The aluminum frame of the UPC-V315-QM77 contains several function keys that control audio volume, LCD brightness and some other system components.

UPC-V315-QM77 Panel PC



Figure 1-8: Function Key Locations

The following table describes the function of these function keys.













| Buttons | Function | Buttons | Function |
|---|-------------------|---|---|
|  | Function | | |
|  | LCD on/off | | |
|  | Audio volume down |  +  | Mute audio |
|  | Audio volume up |  +  | Enable/Disable webcam |
|  | Brightness up | | |
|  | Brightness down |  +  | Power on/off (Turn on: press 3 seconds Turn off: press 6 seconds) |

Table 1-2: Function Keys

1.5 Dimensions

The dimensions of the UPC-V315-QM77 are shown in **Figure 1-9** and listed below.

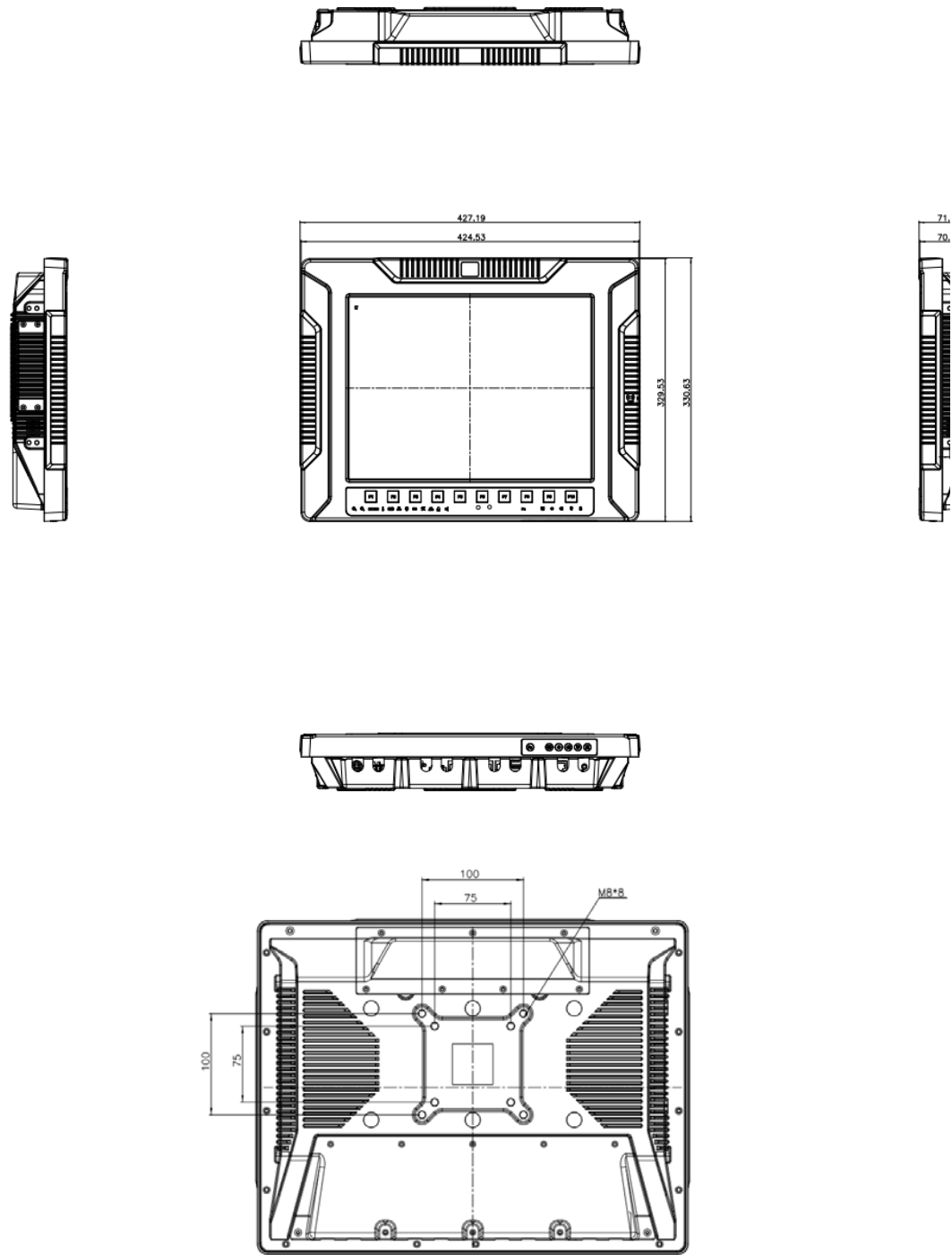

Figure 1-9: UPC-V315-QM77 Dimensions (mm)

UPC-V315-QM77 Panel PC

1.6 Specifications

The technical specifications for the UPC-V315-QM77 system are listed in **Table 1-3**.

| Specification | UPC-V315-QM77 |
|--------------------------------------|---|
| Display | |
| LCD Size | 15" |
| Max. Resolution | 1024(W) x 768(H) |
| Brightness (cd/m²) | 400 |
| Contrast Ratio | 700:1 |
| LCD Color | 16.2 M |
| Pixel Pitch (mm)(HxV) | 0.297(H) x 0.297(V) |
| Viewing Angle (V/H) | 125°/ 140° |
| Backlight MTBF (hrs) | 50000 |
| Touch | |
| Touch Screen | Resistive Type 5-Wire with RS-232 interface |
| Touch Controller | DMC 9000 |
| Motherboard | |
| CPU | Intel® Core™ i3-3217UE Processor/ Intel® Core™ i7-3517UE Processor |
| Chipset | Mobile Intel® QM77 Express Chipset |
| RAM | Built in 1*2GB DDRIII memory (System Max. 8GB: on board Max. 4GB, socket Max. 4GB) |
| Ethernet | Intel® 82579 PHY with Intel® iAMT 8.0 supported Intel® 82583V PCIe controller |
| Audio Codec | Realtek ALC892 HD audio codec |

| | |
|-------------------------------|---|
| System | |
| Audio | AMP 3W + 3W (Internal Speaker) |
| Camera | 2M Mega Pixels |
| Connectivity | |
| Wireless | IEEE 802.11a/b/g/n 3T3R module (WIFI-RT5393-DB-R10) |
| Drive Bay | |
| HDD Driver Bay | 1 x 2.5" SATA SSD |
| SSD | mSATA |
| CD-ROM Driver Bay | N/A |
| Expansion Slot | 1 x PCIe Mini Card |
| System Cooling | Fanless |
| Physical | |
| Construction Material | Aluminium alloy |
| Mounting | VESA 100mm x100mm or 75mm x 75mm with M8 screws |
| Front Panel Color | Orange (Paintone 15C) |
| Dimension (WxHxD) (mm) | 427.19 x 330.63 x 71.6 |
| Net Weight | 7.97KG |
| Environment | |
| Operation Temperature | -20°C ~60°C |
| Storage Temperature | -30°C ~70°C |
| Operating Humidity | 5% ~90%, non-condensing |
| Shock | Half-sine wave shock 3G; 11ms; 3 shocks per axis |
| Vibration | MIL-STD-810F 514.5C-1 (with CF card or SSD) |
| IP Rating | Full IP 65 |

UPC-V315-QM77 Panel PC

| | |
|-------------------------------|---|
| Power | |
| Adapter | 90 W; 63040-010090-020-RS |
| Requirement | Power1:9V~36V(+/-0.3V) Power2:10.5V~36V(+/-0.3V) |
| I/O Ports and Switches | 3 x RS-232 (RJ-45) |
| | 1 x RS-422/485 (RJ-45) |
| | 1 x CAN-BUS |
| | 1 x VGA |
| | 1 x HDMI port |
| | 2 x GbE LAN |
| | 2 x USB 2.0 |
| | 2 x USB 3.0 |
| | 1 x Reset button |
| | 1 x Audio jack (Line out ,MIC) |
| | 1 x DC Jack (10.5 V ~36 V DC) |
| | 1 x Terminal block (9 V ~36 V DC) |
| | 1 x AT / ATX mode switch |
| | 1 x ACC on/off switch |
| 1 x Clear CMOS switch | |
| 1 x Reset button | |

Table 1-3: System Specifications

Chapter

2

Unpacking

UPC-V315-QM77 Panel PC

2.1 Unpacking

To unpack the panel PC, follow the steps below:

**WARNING!**

The front side LCD screen has a protective plastic cover stuck to the screen. Only remove the plastic cover after the panel PC has been properly installed. This ensures the screen is protected during the installation process.

- Step 1:** Use box cutters, a knife or a sharp pair of scissors that seals the top side of the external (second) box.
- Step 2:** Open the external (second) box.
- Step 3:** Use box cutters, a knife or a sharp pair of scissors that seals the top side of the internal (first) box.
- Step 4:** Lift the monitor out of the boxes.
- Step 5:** Remove both polystyrene ends, one from each side.
- Step 6:** Pull the plastic cover off the panel PC.
- Step 7:** Make sure all the components listed in the packing list are present.

2.2 Packing List

The UPC-V315-QM77 panel PC is shipped with the following components:

| Quantity | Item | Image |
|----------|--|--|
| 1 | UPC-V315-QM77 panel PC |  |
| 1 | Power adapter (P/N: 63040-010090-020-RS) |  |
| 1 | Power cord (P/N: 32702-000401-100-RS) |  |
| 1 | Power transfer cord (P/N: 32702-000300-100-RS) |  |
| 4 | RJ-45 to DB-9 COM port cable (P/N: 32005-000200-200-RS) |  |
| 1 | Remote control (P/N: 7Z000-SLPCB001-RS) |  |
| 8 | VESA mount screw (M8) (P/N: 44325-080081-RS) |  |

UPC-V315-QM77 Panel PC

| | | |
|---|---|---|
| 8 | VESA mount screw (M4) (P/N: 44005-040082-RS) |  |
| 2 | Mounting bracket (side panels) (P/N: 41003-0382C2-00-RS) |  |
| 1 | Screw driver (P/N: 45019-001004-00) |  |
| 1 | One Key Recover CD |  |
| 1 | Utility CD |  |

If any of these items are missing or damaged, contact the distributor or sales representative immediately.

Chapter

3

Installation

3.1 Anti-static Precautions

**WARNING:**

Failure to take ESD precautions during the maintenance of the UPC series may result in permanent damage to the UPC series and severe injury to the user.

Electrostatic discharge (ESD) can cause serious damage to electronic components, including the UPC-V315-QM77. Dry climates are especially susceptible to ESD. It is therefore critical that whenever the UPC-V315-QM77 is accessed internally, or any other electrical component is handled, the following anti-static precautions are strictly adhered to.

- **Wear an anti-static wristband:** - Wearing a simple anti-static wristband can help to prevent ESD from damaging the board.
- **Self-grounding:** - Before handling the board touch any grounded conducting material. During the time the board is handled, frequently touch any conducting materials that are connected to the ground.
- **Use an anti-static pad:** - When configuring the UPC-V315-QM77, place it on an anti-static pad. This reduces the possibility of ESD damaging the UPC-V315-QM77.
- **Only handle the edges of the PCB:** - When handling the PCB, hold the PCB by the edges.

3.2 Installation Precautions

When installing the panel PC, please follow the precautions listed below:

- **Power turned off:** When installing the panel PC, make sure the power is off. Failing to turn off the power may cause severe injury to the body and/or damage to the system.
- **Certified Engineers:** Only certified engineers should install and modify onboard functionalities.
- **Anti-static Discharge:** If a user opens the rear panel of the panel PC, to

configure the jumpers or plug in added peripheral devices, ground themselves first and wear an anti-static wristband.

3.3 Preinstalled Components

The following components are all preinstalled.

- Motherboard
- TFT LCD screen
- DDR3 memory module
- Resistive type touch screen
- Stereo speakers
- Wireless module
- Webcam



CAUTION:

The UPC-V315-QM77 is an IP 65 compliant panel PC. A user cannot open the rear cover and install any components inside the UPC-V315-QM77. Doing so may compromise the system's waterproof performance. To install components in the system, please contact the system vendor, reseller or an IEI sales person directly.

3.4 SSD Installation

To install the SSD into the UPC-V315-QM77, please follow the steps below:

Step 1: **Locate the SSD drive bay access panel.** The SSD drive bay access panel is located on the left side panel of the UPC-V315-QM77.

Step 2: **Remove the SSD drive bay access panel** by removing the four retention screws.

UPC-V315-QM77 Panel PC



NOTE:



Please use the screw driver that comes with the UPC-V315-QM77 to remove the screws on the chassis.



Figure 3-1: Remove the SSD Drive Bay Access Panel

Step 3: Insert the SSD into the bracket as shown.



Figure 3-2: Inserting the SSD

Step 4: Secure the SSD to the bracket using four retention screws.

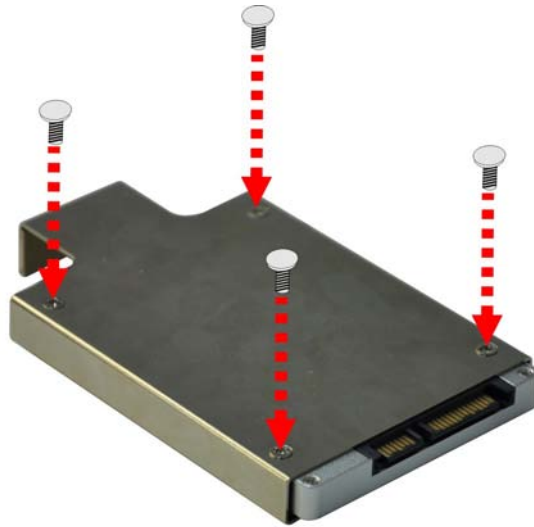

Figure 3-3: Securing the SSD

Step 5: **Install the SSD.** Correctly align the SSD bracket with the system and insert the SSD bracket into the system.



Figure 3-4: SSD Installation

Step 6: Reinstall the SSD drive bay access panel.

UPC-V315-QM77 Panel PC

3.5 Mounting the System

**WARNING:**

When mounting the panel PC onto an arm or onto the wall, it is better to have more than one person to help with the installation to make sure the panel PC does not fall down and get damaged.

The panel PC is VESA (Video Electronics Standards Association) compliant and can be mounted on an arm, a stand or a bracket with a 100 mm/75 mm interface pad. M8 and M4 mounting screws can both be used for VESA mount. The VESA mount retention screw holes of the UPC-V315-QM77 are shown in **Figure 3-5**.

100 mm x 100mm VESA Mount

75 mm x 75mm VESA Mount

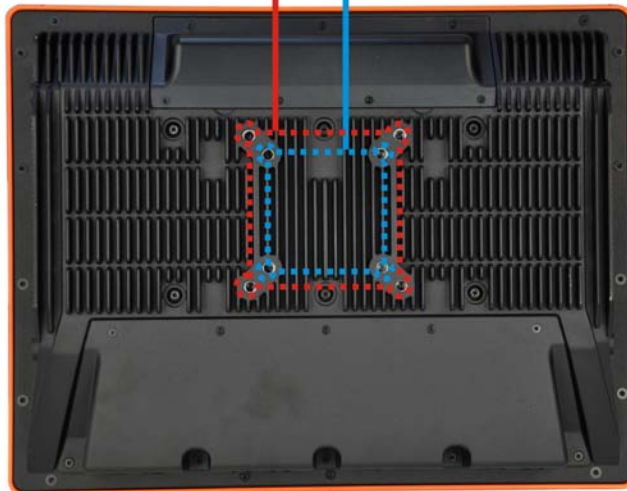

Figure 3-5: VESA Mount Retention Screw Holes

To enhance the stability, the user can use the mounting brackets, which are shipped with the UPC-V315-QM77 and can be attached on both side panels. An additional mounting device is required for the mounting brackets.



Figure 3-6: Mounting Brackets (Side Panels)



NOTE:

When mounting the UPC-V315-QM77 on a vehicle, it is recommended to use the **M8** mounting screws on the rear panel. A special mounting bracket is required for M8 mounting screw. Please contact IEI for more information.

The following installation options are available:

- Wall mounting

The mounting methods are described below.

3.5.1 Wall Mounting

To mount the panel PC onto the wall, please follow the steps below.

- Step 1:** Select the location on the wall for the wall-mounting bracket.
- Step 2:** Carefully mark the locations of the four brackets screw holes on the wall.
- Step 3:** Drill four pilot holes at the marked locations on the wall for the bracket retention screws.
- Step 4:** Align the wall-mounting bracket screw holes with the pilot holes.
- Step 5:** Secure the mounting-bracket to the wall by inserting the retention screws into the four pilot holes and tightening them (Figure 3-7).

UPC-V315-QM77 Panel PC

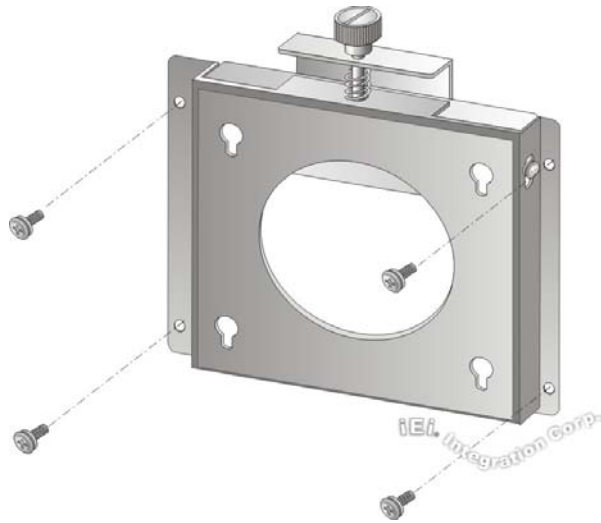

Figure 3-7: Wall-mounting Bracket

- Step 6:** Insert the four monitor mounting screws provided in the wall mounting kit into the four screw holes on the rear panel of the flat panel PC and tighten until the screw shank is secured against the rear panel (Figure 3-8).
- Step 7:** Align the mounting screws on the monitor rear panel with the mounting holes on the bracket.
- Step 8:** Carefully insert the screws through the holes and gently pull the monitor downwards until the monitor rests securely in the slotted holes (Figure 3-8). Ensure that all four of the mounting screws fit snugly into their respective slotted holes.

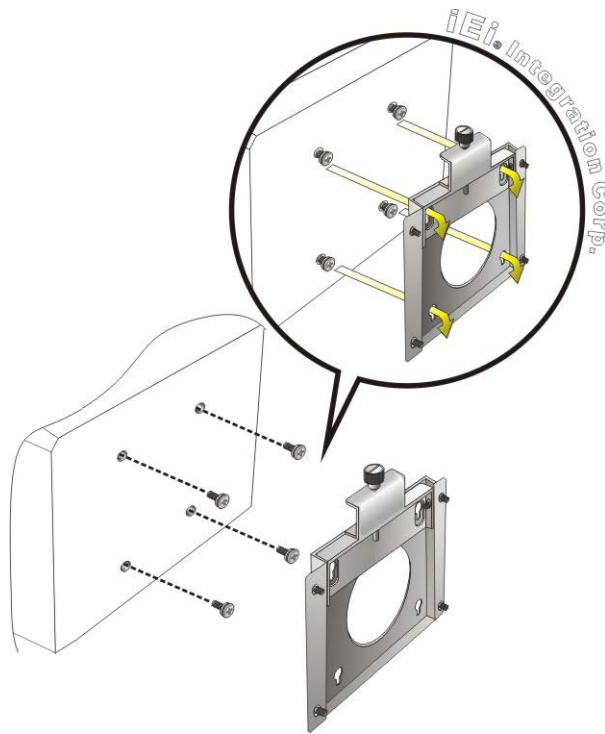

Figure 3-8: Chassis Support Screws



NOTE:

In the diagram below the bracket is already installed on the wall.

-
- Step 9:** Secure the panel PC by fastening the retention screw of the wall-mounting bracket. (Figure 3-9).

UPC-V315-QM77 Panel PC

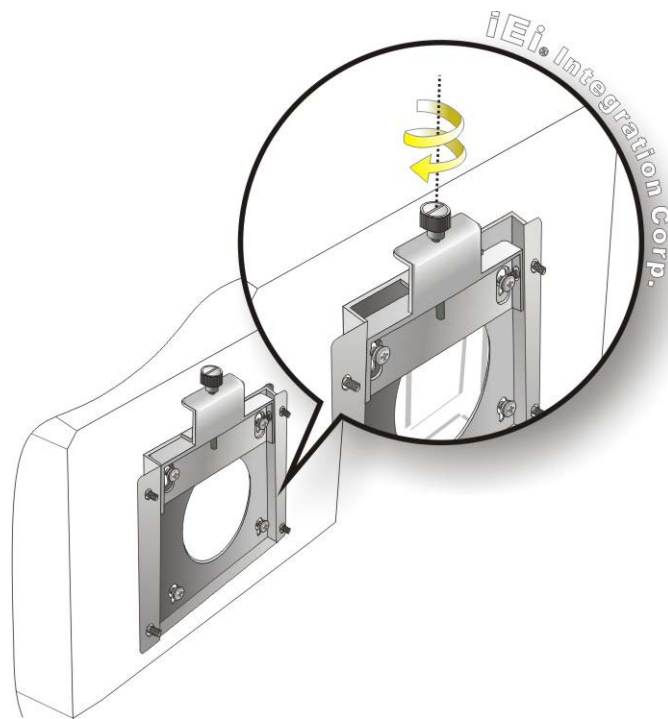

Figure 3-9: Secure the Panel PC

3.6 Bottom Panel Connectors

The bottom panel of the UPC-V315-QM77 contains I/O connectors, switches and a reset button. These connectors are protected by an I/O cover. Detailed descriptions of the connectors can be found in the subsections below.

3.6.1 External Peripheral Device Connection

To install external peripheral devices to the UPC-V315-QM77, please follow the steps below.

Step 1: Remove the I/O cover by removing the ten retention screws as shown in **Figure 3-10**.



Figure 3-10: I/O Cover Retention Screws

Step 2: Connect the cable from the external peripheral device to the corresponding connector of the UPC-V315-QM77 (**Figure 3-11**).



Figure 3-11: External Peripheral Device Connection

Step 3: Take out a rubber gasket from the I/O cover (**Figure 3-12**).



Figure 3-12: Rubber Gasket Removal

Step 4: Remove some rubber rings from the gasket to make the gasket fit perfectly to the size of the cable (**Figure 3-13**).

UPC-V315-QM77 Panel PC



Figure 3-13: Rubber Gasket and Cable

Step 5: Repeat steps to other connected cables.

Step 6: Install the I/O cover and make sure each rubber gasket snaps into place tightly.

Step 7: Secure the I/O cover by the previously removed retention screws.



Figure 3-14: External Peripheral Device Connection Complete

3.6.2 ACC Mode Selection

The ACC mode can be turned on or off. The setting is made through the ACC mode switch on the bottom panel as shown below.



Figure 3-15: ACC Mode Switch

3.6.3 AT/ATX Power Mode Selection

The UPC-V315-QM77 supports both AT and ATX power modes. The setting can be made through the AT/ATX power mode switch on the bottom panel as shown below.

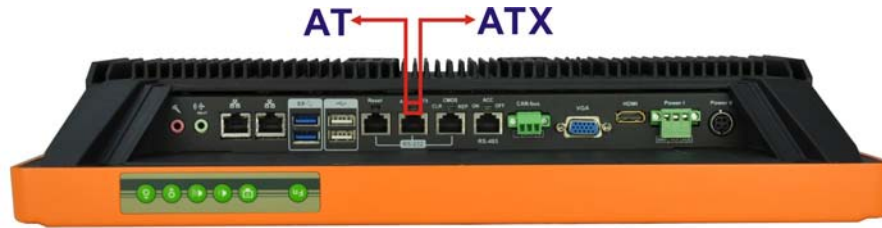

Figure 3-16: AT/ATX Power Mode Switch

3.6.4 Audio Connectors

The audio jacks connect to external audio devices.

- **Microphone (Pink):** Connects a microphone.
- **Line Out port (Green):** Connects to a headphone or a speaker. With multi-channel configurations, this port can also connect to front speakers.

3.6.5 CAN-bus Terminal Block

There is one 3-pin CAN-bus terminal block. The pinouts are shown in **Figure 3-17**

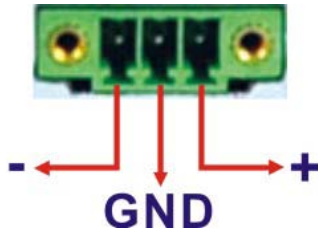

Figure 3-17: CAN-bus Terminal Block Pinouts

3.6.6 HDMI Connector

The HDMI connector transmits a digital signal to compatible HDMI display devices such as a TV or computer screen. To connect the HDMI cable to the UPC-V315-QM77, follow the steps below.

Step 1: **Locate the HDMI connector.** The location is shown in **Chapter 1**.

Step 2: **Align the connector.** Align the HDMI connector with the HDMI port. Make sure the orientation of the connector is correct.

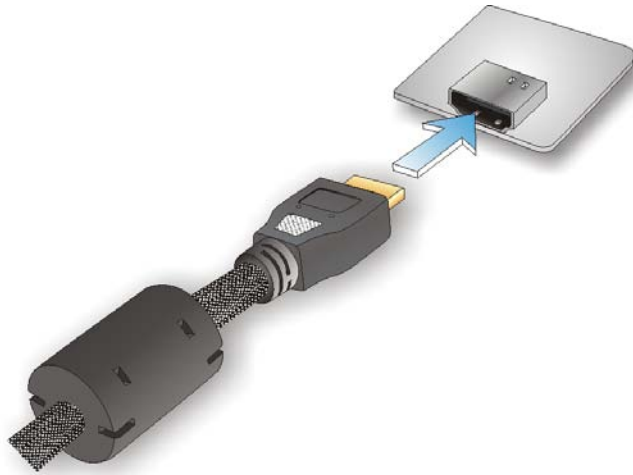

Figure 3-18: HDMI Connection

Step 3: Insert the HDMI connector. Gently insert the HDMI connector. The connector should engage with a gentle push. If the connector does not insert easily, check again that the connector is aligned correctly, and that the connector is being inserted with the right way up.

The pinouts of the HDMI connector is shown below.

| Pin | Description | Pin | Description |
|-----|-------------|-----|-------------|
| 1 | HDMI_DATA2 | 2 | GND |
| 3 | HDMI_DATA2# | 4 | HDMI_DATA1 |
| 5 | GND | 6 | HDMI_DATA1# |
| 7 | HDMI_DATA2 | 8 | GND |
| 9 | HDMI_DATA2# | 10 | HDMI_CLK |
| 11 | GND | 12 | HDMI_CLK# |
| 13 | NC | 14 | NC |
| 15 | HDMI_SCL | 16 | HDMI_SDA |
| 17 | GND | 18 | +5V |
| 19 | HDMI_HPD | | |

Table 3-1: HDMI Pinouts

3.6.7 LAN Connector

To connect the UPC-V315-QM77 to a network through the RJ-45 LAN connector, follow the steps below.

- Step 1:** Locate the RJ-45 connector. The location of the RJ-45 connectors is shown in **Figure 1-4**.
- Step 2:** **Align the connectors.** Align the RJ-45 connector on the LAN cable with one of the RJ-45 connectors on the UPC-V315-QM77. See **Figure 3-19**.

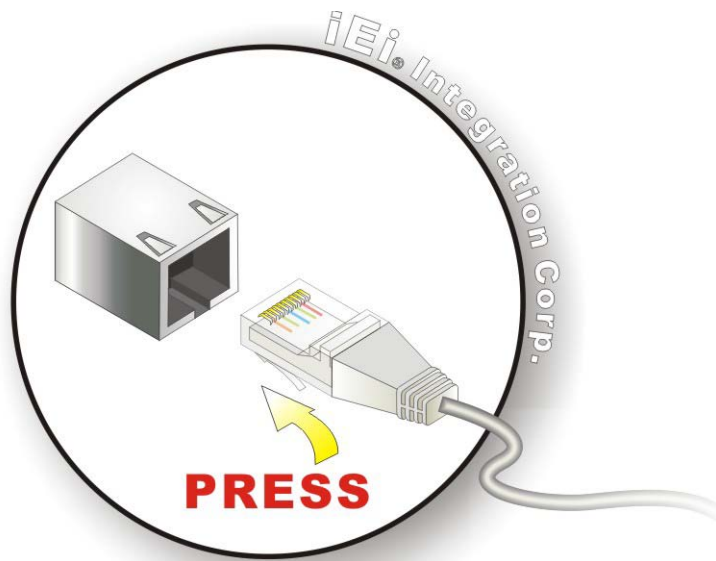

Figure 3-19: LAN Connection

- Step 3:** **Insert the LAN cable RJ-45 connector.** Once aligned, gently insert the LAN cable RJ-45 connector into the on-board RJ-45 connector.

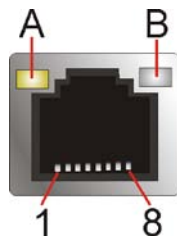

Figure 3-20: RJ-45 Ethernet Connector

UPC-V315-QM77 Panel PC

The pinouts of the RJ-45 LAN connector is shown below.

| Pin | Description | Pin | Description |
|-----|-------------|-----|-------------|
| 1 | MDI0+ | 2 | MDI0- |
| 3 | MDI1+ | 4 | MDI1- |
| 5 | MDI2+ | 6 | MDI2- |
| 7 | MDI3+ | 8 | MDI3- |

Table 3-2: LAN Pinouts

The RJ-45 Ethernet connector has two status LEDs, one green and one yellow. See **Figure 3-20**.

| LED | Description | LED | Description |
|-----|---|-----|--|
| A | on: linked blinking: data is being sent/received | B | off: 10 Mb/s green: 100 Mb/s orange: 1000 Mb/s |

Table 3-3: RJ-45 Ethernet Connector LEDs

3.6.8 Power Input, 3-pin Terminal Block

The power connector connects the leads of a 9V~36V DC power supply into the terminal block. Make sure that the power and ground wires are attached to the correct sockets of the connector.

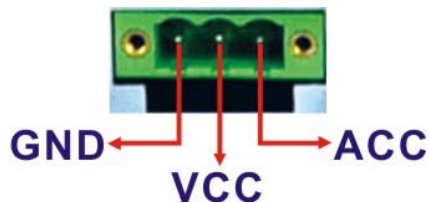

Figure 3-21: 3-pin Terminal Block Pinouts

3.6.9 Power Input, 4-pin DIN Connector

The power connector connects to the 10.5 V ~ 36 V DC power adapter.

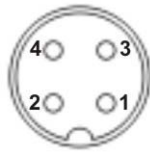

Figure 3-22: Power Input Connector

3.6.10 RJ-45 RS-232 Serial Port

RS-232 serial port devices can be attached to the RJ-45 RS-232 serial ports on the bottom panel. The pinouts of the RJ-45 RS-232 serial port is shown below.

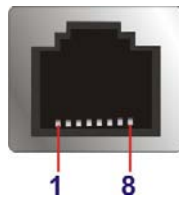

Figure 3-23: RJ-45 RS-232 Serial Port Pinout Location

| Pin | Description | Pin | Description |
|-----|-------------|-----|-------------|
| 1 | RI | 5 | RTS |
| 2 | DTR | 6 | RX |
| 3. | CTS | 7 | DSR |
| 4. | TX | 8 | DCD |

Table 3-4: RJ-45 RS-232 Serial Port Pinouts

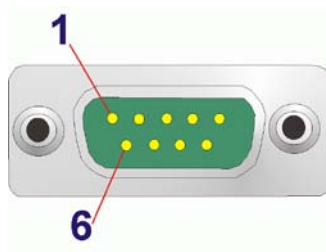

Figure 3-24: DB-9 Connector Pinout Location

| Pin | Description | Pin | Description |
|-----|-------------|-----|-------------|
| 1 | DCD | 6 | DSR |
| 2 | RX | 7 | RTS |

UPC-V315-QM77 Panel PC

| Pin | Description | Pin | Description |
|-----|-------------|-----|-------------|
| 3 | TX | 8 | CTS |
| 4 | DTR | 9 | RI |
| 5 | GND | | |

Table 3-5: DB-9 Connector Pinouts

To install the RS-232 devices, follow the steps below.

Step 1: Locate the RJ-45 RS-232 connector. The location of the RJ-45 RS-232 connector is shown in **Figure 1-4**.

Step 2: Insert the RJ-45 connector. Insert the RJ-45 connector on the RJ-45 to DB-9 COM port cable to the RJ-45 RS-232 connector on the UPC-V315-QM77. See **Figure 3-25**.

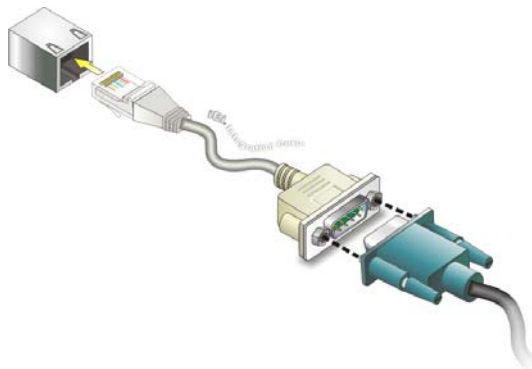

Figure 3-25: RJ-45 RS-232 Serial Device Connection

Step 3: Insert the serial connector. Insert the DB-9 connector of a serial device into the DB-9 connector on the RJ-45 to DB-9 COM port cable.

Step 4: Secure the connector. Secure the serial device connector to the external interface by tightening the two retention screws on either side of the connector.

3.6.11 RJ-45 RS-422/485 Serial Port

A RS-422/485 serial port device can be connected to the RS-422/485 serial port on the bottom panel. The pinouts of the RS-422/485 serial port is shown below.

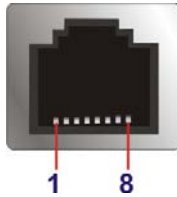

Figure 3-26: RJ-45 RS-422/485 Serial Port Pinout Location

| Pin | Description | Pin | Description |
|-----|-------------|-----|-------------|
| 1 | N/A | 5 | N/A |
| 2 | TXD485# | 6 | RXD485# |
| 3 | N/A | 7 | N/A |
| 4 | TXD485+ | 8 | RXD485+ |

Table 3-6: RJ-45 RS-422/485 Serial Port Pinouts

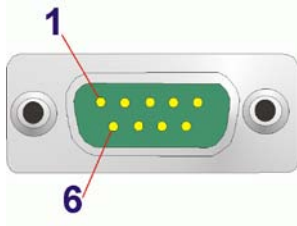

Figure 3-27: DB-9 Connector Pinout Location

| Pin | Description (RS-422) | Description (RS-485) |
|-----|----------------------|----------------------|
| 1 | RXD422+ | N/A |
| 2 | RXD422# | N/A |
| 3 | TXD422+ | TXD485+ |
| 4 | TXD422# | TXD485# |
| 5 | N/A | N/A |
| 6 | N/A | N/A |
| 7 | N/A | N/A |
| 8 | N/A | N/A |
| 9 | N/A | N/A |

Table 3-7: DB-9 Connector Pinouts

UPC-V315-QM77 Panel PC

To install the RS-422/485 devices, follow the steps below.

- Step 1: Locate the RJ-45 RS-422/485 connector.** The location of the RJ-45 RS-422/485 connector is shown in **Figure 1-4**.
- Step 2: Insert the RJ-45 connector.** Insert the RJ-45 connector on the RJ-45 to DB-9 COM port cable to the RJ-45 RS-422/485 connector on the UPC-V315-QM77. See **Figure 3-25**.

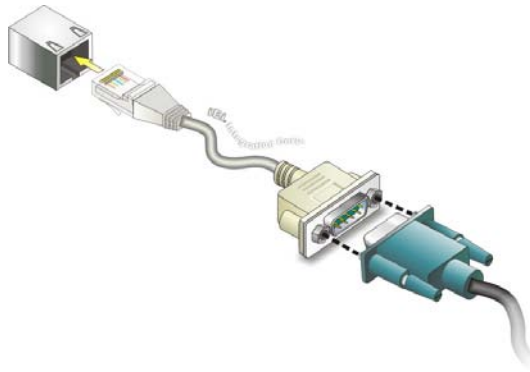

Figure 3-28: RJ-45 RS-422/485 Serial Device Connection

- Step 3: Insert the serial connector.** Insert the DB-9 connector of a serial device into the DB-9 connector on the RJ-45 to DB-9 COM port cable.
- Step 4: Secure the connector.** Secure the serial device connector to the external interface by tightening the two retention screws on either side of the connector.

3.6.12 USB Connectors

The USB ports are for attaching USB peripheral devices to the system. To install a USB device, follow the steps below.

- Step 1: Locate the USB connectors.** The locations of the USB connectors are shown in **Figure 1-4**.
- Step 2: Align the connectors.** Align the USB device connector with one of the connectors. See **Figure 3-29**.

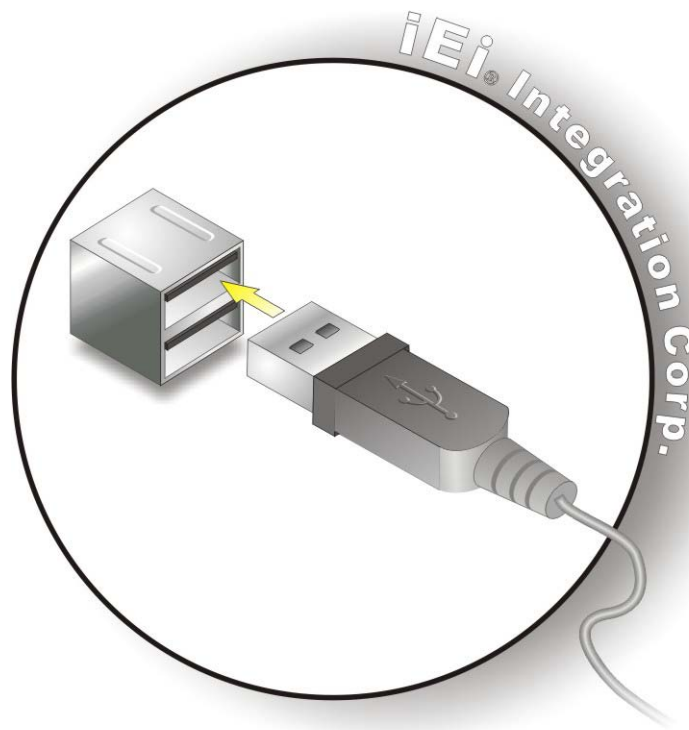

Figure 3-29: USB Device Connection

Step 3: Insert the device connector. Once aligned, gently insert the USB device connector into the on-board connector.

The pinouts of the USB ports are shown below.

| Pin | Description | Pin | Description |
|-----|-------------|-----|-------------|
| 1 | +5V | 5 | +5V |
| 2 | USB_PN0 | 6 | USB_PN1 |
| 3 | USB_PPO | 7 | USB_PP1 |
| 4 | GND | 8 | GND |

Table 3-8: USB Port Pinouts (USB 2.0)

| Pin | Description | Pin | Description |
|-----|-------------|-----|-------------|
| 1 | +5V | 10 | +5V |
| 2 | USB2P0_N | 11 | USB2P1_N |
| 3 | USB2P0_P | 12 | USB2P1_P |
| 4 | GND | 13 | GND |

UPC-V315-QM77 Panel PC

| Pin | Description | Pin | Description |
|-----|-------------|-----|-------------|
| 5 | USB3P0_RXN | 14 | USB3P1_RXN |
| 6 | USB3P0_RXP | 15 | USB3P1_RXP |
| 7 | GND | 16 | GND |
| 8 | USB3P0_TXN | 17 | USB3P1_TXN |
| 9 | USB3P0_TXP | 18 | USB3P1_TXP |

Table 3-9: USB Port Pinouts (USB 3.0)

3.6.13 VGA Connector

The VGA connector connects to a monitor that accepts VGA video input. The pinouts of the VGA connector is shown below.

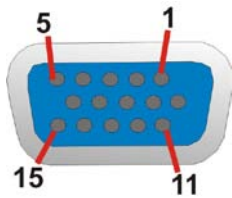

Figure 3-30: VGA Connector

| Pin | Description | Pin | Description |
|-----|-------------|-----|-------------|
| 1 | RED | 2 | GREEN |
| 3 | BLUE | 4 | NC |
| 5 | GND | 6 | GND |
| 7 | GND | 8 | GND |
| 9 | VCC / NC | 10 | GND |
| 11 | NC | 12 | DDC DAT |
| 13 | HSYNC | 14 | VSYNC |
| 15 | DDCCLK | | |

Table 3-10: VGA Connector Pinouts

To connect the UPC-V315-QM77 to a monitor that accepts VGA video input, follow the steps below,

- Step 1: Locate the female DB-15 connector.** The location of the female DB-15 connector is shown in Figure 1-4.
- Step 2: Align the VGA connector.** Align the male DB-15 connector on the VGA screen cable with the female DB-15 connector on the external peripheral interface.
- Step 3: Insert the VGA connector** Once the connectors are properly aligned with the insert the male connector from the VGA screen into the female connector on the UPC-V315-QM77. See **Figure 3-31**.

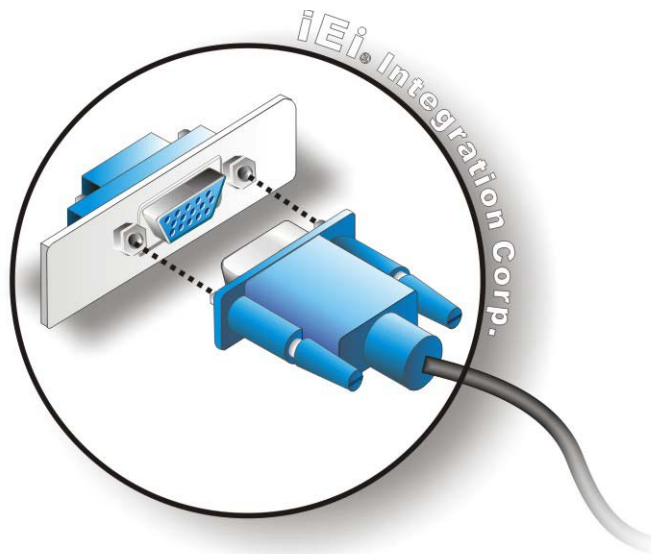

Figure 3-31: VGA Connector



CAUTION:

It is suggested that not to open the rear cover and replace any components. If the components fail, it must be shipped back to IEI to be replaced. If the system has failed, please contact the system vendor, reseller or an IEI sales person directly.

UPC-V315-QM77 Panel PC

3.7 Redundant Power

The UPC-V315-QM77 is a system that supports redundant power. The redundant power input increases the reliability of the system while preventing data loss and system corruption from sudden power failure. The system can instantly and uninterruptedly switch to the second power input when the main power is unavailable or in low voltage capacity.

There are two power connectors on the bottom panel. Power 1 connector is a 3-pin terminal block that supports ACC On signal. Power 2 connector is a DIN connector that can directly connect to a power adapter. The supported power input voltages are:

- **Power 1 (Terminal block):** 9 V (+/-0.3 V) ~ 36 V
- **Power 2 (DC jack):** 10.5 V (+/-0.3 V) ~ 36 V

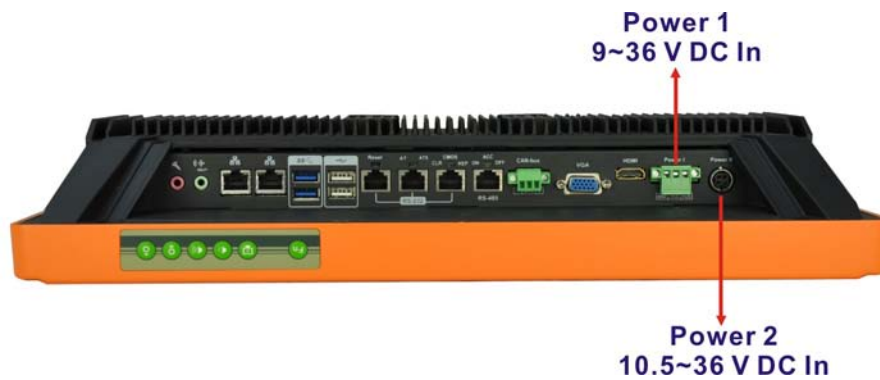

Figure 3-32: Power Connectors

When the system is in ACC On mode, the main power input is from the Power 1 connector. When the system is in ACC Off mode, the main power input is from the Power 2 connector. The ACC on/off mode is selected by the ACC on/off switch on the bottom panel.

(Figure 3-15).

The following sections describe how redundant power works in ACC On mode and ACC Off mode.

3.7.1 ACC ON



NOTE:

In ACC On mode, the Power 1 connector must connect to the ACC on signal to be able to control system power.

The ACC On mode is designed for vehicle applications. When the UPC-V315-QM77 is in ACC On mode, the main power input is the Power 1 connector and the backup power is from the Power 2 connector.

3.7.1.1 Boot-up

When both power connectors are connected to the power source with over 9 V, the two power LEDs on the front panel remain off until **the ACC ON signal jumps from low to high**. The user can choose AT power mode or ATX power mode to control the system. The following flow diagrams show the boot-up process and the LED status in AT and ATX power modes.

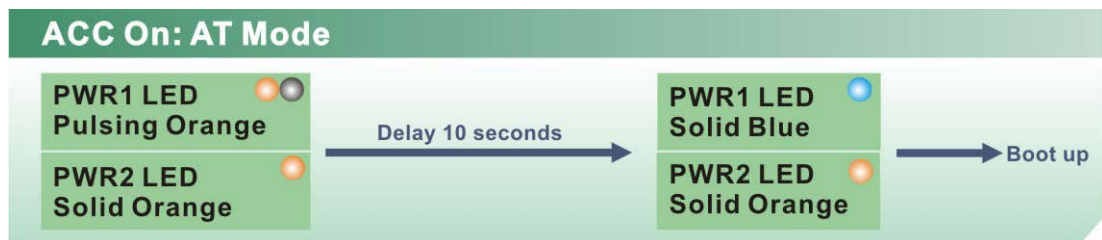

Figure 3-33: ACC On: AT Mode

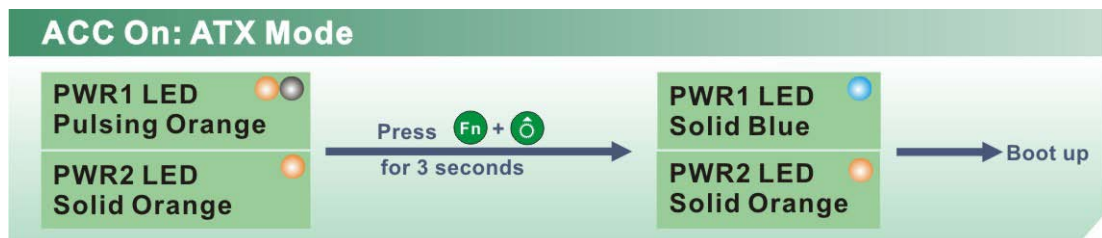

Figure 3-34: ACC On: ATX Mode

UPC-V315-QM77 Panel PC

3.7.1.2 Switch to Backup Power

During operation, system power will switch from Power 1 to Power 2 automatically when the following situations occur:

- Power 1 < 9V and Power 2 > 10.5V
- Power 1 > 9V, but the ACC ON signal jump from high to low
- Power 1 is unplugged and Power 2 > 10.5V

The following flow diagram shows how the power is switched between Power 1 and Power 2 and their LED statuses.

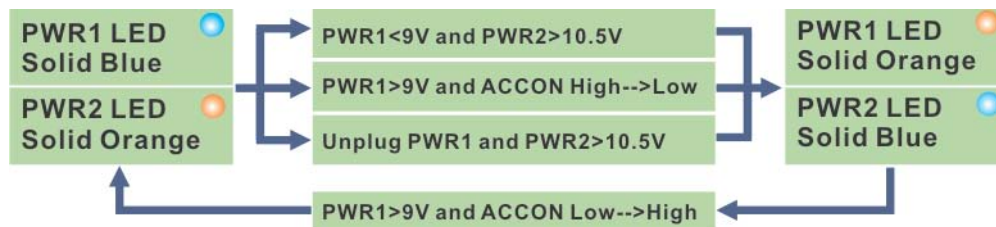

Figure 3-35: ACC On: Switch Between PWR1 and PWR2

3.7.1.3 Shutdown

The system will shutdown in the following situations:

- Power 1 < 9V and Power 2 < 10.5V
- Power 1 > 9V, Power 2 < 10.5V and ACC ON signal jump from high to low
- Press **Fn** + **⏻** buttons for 6 seconds

The following flow diagram shows the system shutdown process and the LED statuses.



Figure 3-36: ACC On: Shutdown



NOTE:

To turn on the system in ATX power mode, press the  button for three seconds. Press these two buttons for six seconds to turn off the system.

3.7.2 ACC OFF

When the UPC-V315-QM77 is in ACC Off mode, the main power input is the Power 2 connector and the backup power is from the Power 1 connector.

3.7.2.1 Boot-up

When both power connectors are connected to the power source with over 9 V, the two power LEDs on the front panel turn on. The user can choose AT power mode or ATX power mode to control the system. The following flow diagrams show the boot-up process and the LED status in AT and ATX power modes.

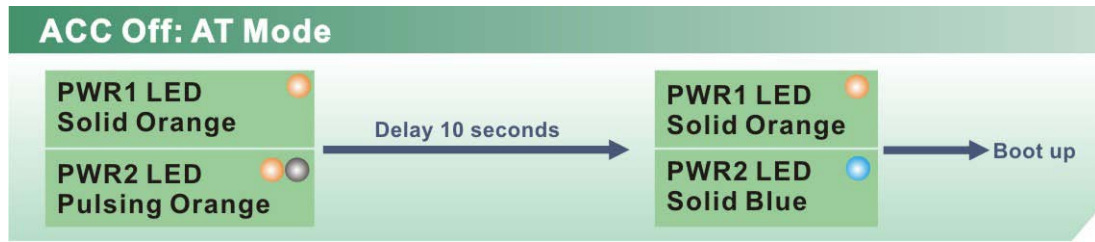

Figure 3-37: ACC Off: AT Mode

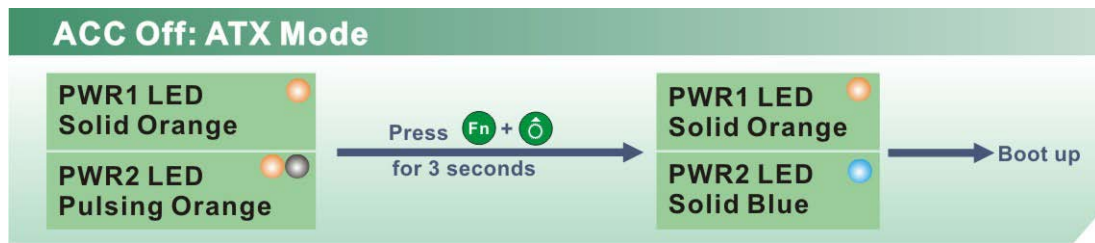

Figure 3-38: ACC Off: ATX Mode

3.7.2.2 Switch to Backup Power

During operation, system power switches from Power 2 to Power 1 automatically when the following situations occur:

- Power 2 < 10.5V and Power 1 > 9V
- Power 2 is unplugged and Power 1 > 9V

The following flow diagram shows how the power is switched between Power 2 and Power 1 and their LED statuses.

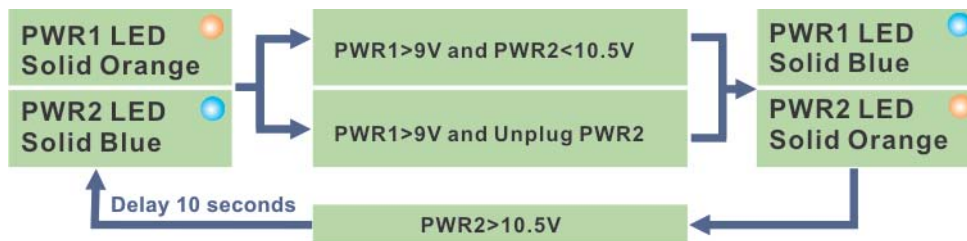

Figure 3-39: ACC Off: Switch Between PWR1 and PWR2

3.7.2.3 Shutdown

The system will shutdown in the following situations:

- Power 2 < 10.5V and Power 1 < 9V
- Press **Fn** + **⏻** buttons for 6 seconds

The following flow diagram shows the system shutdown process and the LED statuses.

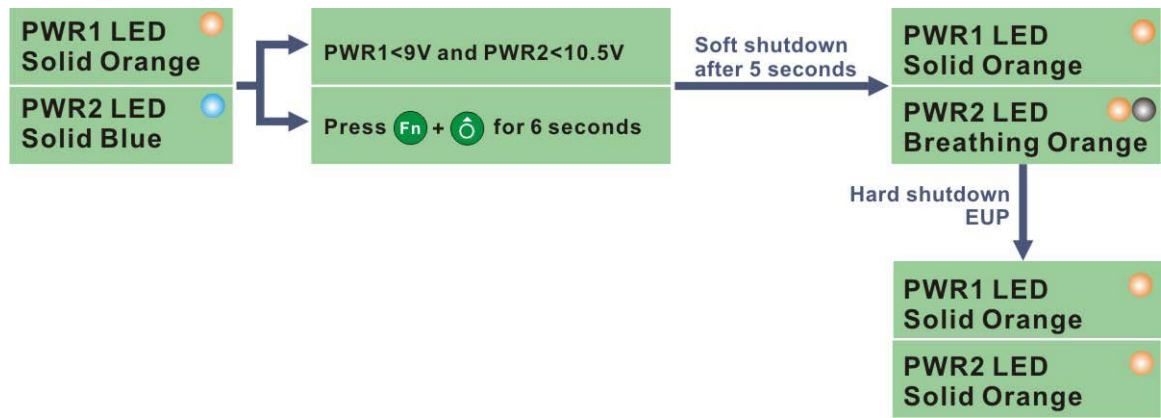

Figure 3-40: ACC Off: Shutdown



NOTE:

The power LED turns off when the power cable is unplugged from the system.

UPC-V315-QM77 Panel PC

3.8 Remote Control

The UPC-V315-QM77 comes with a remote control for easy configuration. **Figure 3-41** shows the remote control and its function keys.

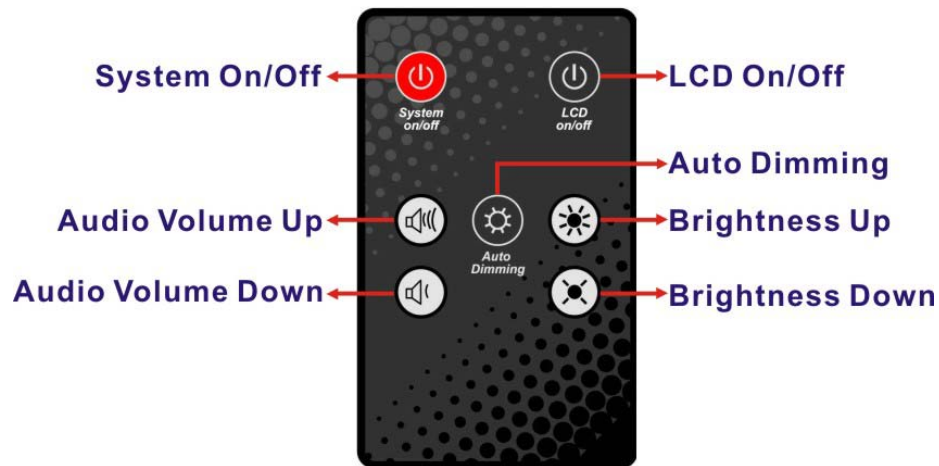

Figure 3-41: Remote Control

- **System On/Off:** Press this button to turn the UPC-V315-QM77 on or off.
- **LCD On/Off.** Press this button to turn the LCD monitor on or off.
- **Auto-Dimming.** Press this button to turn the auto-dimming function on or off.
- **Brightness.** Use these control buttons to adjust the brightness of the LCD screen.
- **Volume.** Press these buttons to adjust the audio volume level.

Chapter

4

BIOS

4.1 Introduction

The BIOS is programmed onto the BIOS chip. The BIOS setup program allows changes to certain system settings. This chapter outlines the options that can be changed.

4.1.1 Starting Setup

The UEFI BIOS is activated when the computer is turned on. The setup program can be activated in one of two ways.

1. Press the **DEL** or **F2** key as soon as the system is turned on or
2. Press the **DEL** or **F2** key when the “**Press DEL or F2 to enter SETUP**” message appears on the screen.

If the message disappears before the **DEL** or **F2** key is pressed, restart the computer and try again.

4.1.2 Using Setup

Use the arrow keys to highlight items, press **ENTER** to select, use the PageUp and PageDown keys to change entries, press **F1** for help and press **ESC** to quit. Navigation keys are shown in.

| Key | Function |
|-------------|--|
| Up arrow | Move to previous item |
| Down arrow | Move to next item |
| Left arrow | Move to the item on the left hand side |
| Right arrow | Move to the item on the right hand side |
| + | Increase the numeric value or make changes |
| - | Decrease the numeric value or make changes |
| Page Up key | Move to the previous page |
| Page Dn key | Move to the next page |

| Key | Function |
|---------|--|
| Esc key | Main Menu – Quit and not save changes into CMOS Status Page Setup Menu and Option Page Setup Menu -- Exit current page and return to Main Menu |
| F1 | General help, only for Status Page Setup Menu and Option Page Setup Menu |
| F2 | Load previous values |
| F3 | Load optimized defaults |
| F4 | Save changes and Exit BIOS |

Table 4-1: BIOS Navigation Keys

4.1.3 Getting Help

When **F1** is pressed a small help window describing the appropriate keys to use and the possible selections for the highlighted item appears. To exit the Help Window press **Esc** or the **F1** key again.

4.1.4 Unable to Reboot after Configuration Changes

If the computer cannot boot after changes to the system configuration is made, CMOS defaults. Use the jumper described in Chapter 4.

4.1.5 BIOS Menu Bar

The **menu bar** on top of the BIOS screen has the following main items:

- Main – Changes the basic system configuration.
- Advanced – Changes the advanced system settings.
- Chipset – Changes the chipset settings.
- Boot – Changes the system boot configuration.
- Security – Sets User and Supervisor Passwords.
- Save & Exit – Selects exit options and loads default settings

The following sections completely describe the configuration options found in the menu items at the top of the BIOS screen and listed above.

UPC-V315-QM77 Panel PC

4.2 Main

The **Main** BIOS menu (**BIOS Menu 1**) appears when the **BIOS Setup** program is entered.

The **Main** menu gives an overview of the basic system information.

```

Aptio Setup Utility - Copyright (C) 2011 American Megatrends, Inc.
Main  Advanced  Chipset  Boot  Security  Save & Exit

BIOS Information
BIOS Vendor                American Megatrends
Core Version                4.6.5.3
Compliance                 UEFI 2.3; PI 1.2
Project Version            SE31AR12.ROM
Build Date and Time        03/25/2013 10:54:06

IWDD Vender                ICP
IWDD Version               SE31ER13.BIN

Processor Information
Name                       IvyBridge
Brand String               Intel(R) Core(TM) i3-
Frequency                  1500 MHz
Processor ID                306a9
Stepping                   E1
Number of Processors       2Core(s) / 4Thread(s)
Microcode Revision         10
GT Info                     GT2 (900 MHz)

IGFX VBIOS Version         2137
Memory RC Version          1.2.0.0
Total Memory                2048 MB (DDR3)
Memory Frequency           1333 MHz

PCH Information
Name                       PantherPoint
Stepping                   04/C1
LAN PHY Revision           C0

ME FW Version               8.0.3.1427
ME Firmware SKU             5MB

SPI Clock Frequency
DOFR Support                Supported
Read Status Clock Frequency 33 MHz
Write Status Clock Frequency 33 MHz
Fast Read Status Clock Frequency 33 MHz

System Date                 [Mon 04/08/2013]
System Time                 [15:10:27]

Access Level                Administrator

Set the Date. Use Tab to
switch between Data
elements.

-----
-><: Select Screen
↑↓: Select Item
Enter: Select
+/-: Change Opt.
F1: General Help
F2: Previous Values
F3: Optimized Defaults
F4: Save & Exit
ESC: Exit

Version 2.14.1219. Copyright (C) 2011 American Megatrends, Inc.
  
```

BIOS Menu 1: Main

→ System Overview

The system overview lists a brief summary of the BIOS. The fields in system overview cannot be changed. The items shown in the system overview include:

- BIOS Information
- IWDD Information
- Processor Information
- Memory Information
- PCH Information
- ME Information
- SPI Clock Frequency

The **Main** menu has two user configurable fields:

→ System Date [xx/xx/xx]

Use the **System Date** option to set the system date. Manually enter the day, month and year.

→ System Time [xx:xx:xx]

Use the **System Time** option to set the system time. Manually enter the hours, minutes and seconds.

4.3 Advanced

Use the **Advanced** menu (**BIOS Menu 2**) to configure the CPU and peripheral devices through the following sub-menus:



WARNING!

Setting the wrong values in the sections below may cause the system to malfunction. Make sure that the settings made are compatible with the hardware.

UPC-V315-QM77 Panel PC

```

Aptio Setup Utility - Copyright (C) 2011 American Megatrends, Inc.
Main  Advanced  Chipset  Boot  Security  Save & Exit

> ACPI Settings
> RTC Wake Settings
> CPU Configuration
> SATA Configuration
> Intel(R) Rapid Start Technology
> USB Configuration
> F81866 Super IO Configuration
> F81866 H/M Monitor
> Serial Port Console Redirection
> iEi Feature

System ACPI Parameters
-----
-><: Select Screen
↑↓: Select Item
Enter: Select
+/-: Change Opt.
F1: General Help
F2: Previous Values
F3: Optimized Defaults
F4: Save & Exit
ESC: Exit

Version 2.14.1219. Copyright (C) 2011 American Megatrends, Inc.
  
```

BIOS Menu 2: Advanced

4.3.1 ACPI Settings

The **ACPI Settings** menu (**BIOS Menu 3**) configures the Advanced Configuration and Power Interface (ACPI) options.

```

Aptio Setup Utility - Copyright (C) 2011 American Megatrends, Inc.
Advanced

ACPI Settings
ACPI Sleep State          [S1 (CPU Stop Clock)]

Select ACPI sleep state
the system will enter
when the SUSPEND button
is pressed.
-----
-><: Select Screen
↑↓: Select Item
Enter: Select
+/-: Change Opt.
F1: General Help
F2: Previous Values
F3: Optimized Defaults
F4: Save & Exit
ESC: Exit

Version 2.14.1219. Copyright (C) 2011 American Megatrends, Inc.
  
```

BIOS Menu 3: ACPI Configuration

➔ ACPI Sleep State [S1 (CPU Stop Clock)]

Use the **ACPI Sleep State** option to specify the sleep state the system enters when it is not being used.

- ➔ **S1 (CPU Stop Clock)** **DEFAULT** The system enters S1 (POS) sleep state. The system appears off. The CPU is stopped; RAM is refreshed; the system is running in a low power mode.
- ➔ **S3 (Suspend to RAM)** The caches are flushed and the CPU is powered off. Power to the RAM is maintained. The computer returns slower to a working state, but more power is saved.

4.3.2 RTC Wake Settings

The **RTC Wake Settings** menu (**BIOS Menu 4**) enables the system to wake at the specified time.

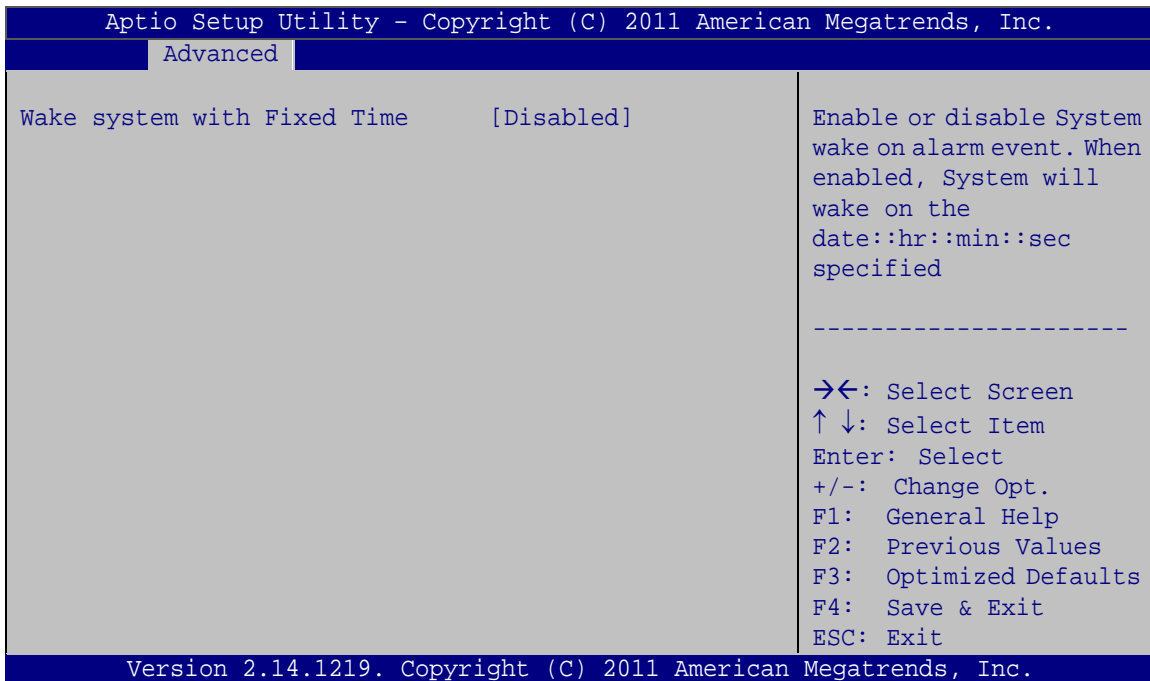

BIOS Menu 4: RTC Wake Settings

UPC-V315-QM77 Panel PC

→ Wake system with Fixed Time [Disabled]

Use the **Wake system with Fixed Time** option to enable or disable the system wake on alarm event.

→ **Disabled** **DEFAULT** The real time clock (RTC) cannot generate a wake event

→ **Enabled** If selected, the **Wake up every day** option appears allowing you to enable to disable the system to wake every day at the specified time. Besides, the following options appear with values that can be selected:

Wake up date

Wake up hour

Wake up minute

Wake up second

After setting the alarm, the computer turns itself on from a suspend state when the alarm goes off.

4.3.3 CPU Configuration

Use the **CPU Configuration** menu (**BIOS Menu 5**) to view detailed CPU specifications or enable the Intel Virtualization Technology.

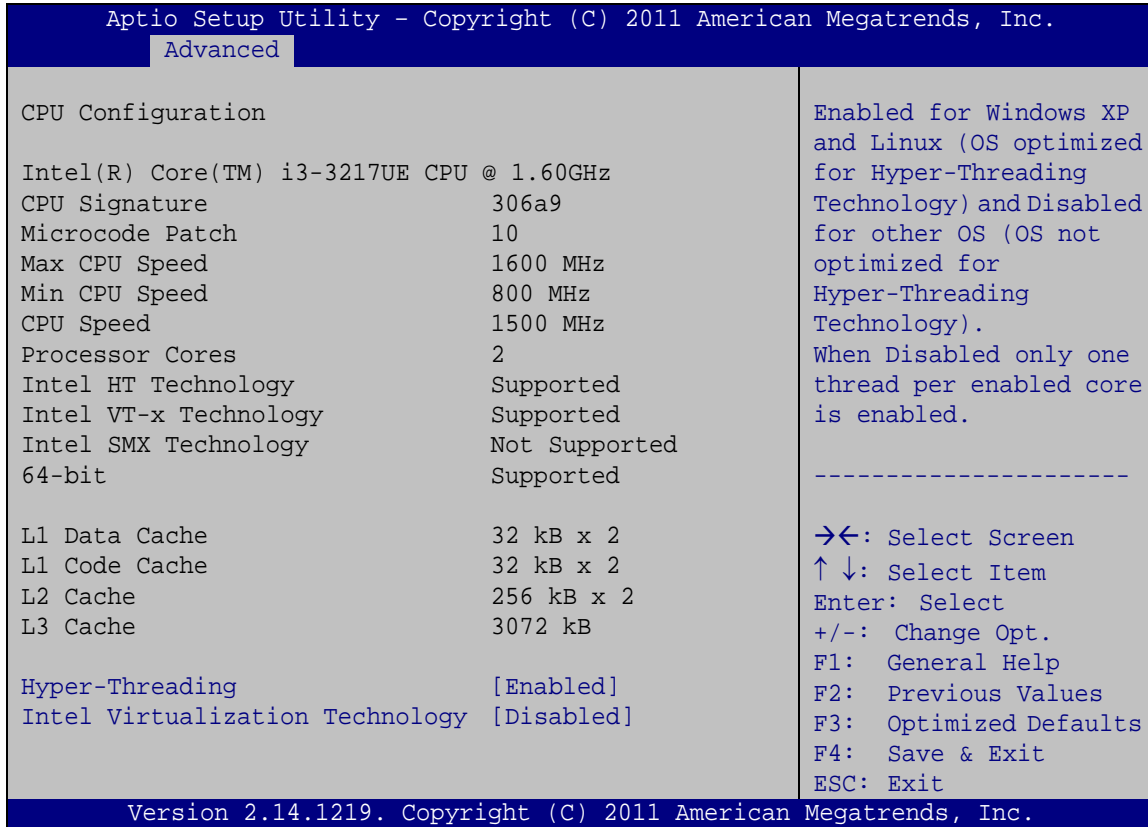

BIOS Menu 5: CPU Configuration

→ Hyper-threading [Enabled]

Use the **Hyper-threading** function to enable or disable the CPU hyper threading function.

→ **Disabled** Disables the use of hyper-threading technology

→ **Enabled** **DEFAULT** Enables the use of hyper-threading technology

→ Intel Virtualization Technology [Disabled]

Use the **Intel Virtualization Technology** option to enable or disable virtualization on the system. When combined with third party software, Intel® Virtualization technology allows several OSs to run on the same system at the same time.

→ **Disabled** **DEFAULT** Disables Intel Virtualization Technology.

→ **Enabled** Enables Intel Virtualization Technology.

UPC-V315-QM77 Panel PC

4.3.4 SATA Configuration

Use the **SATA Configuration** menu (**BIOS Menu 6**) to change and/or set the configuration of the SATA devices installed in the system.

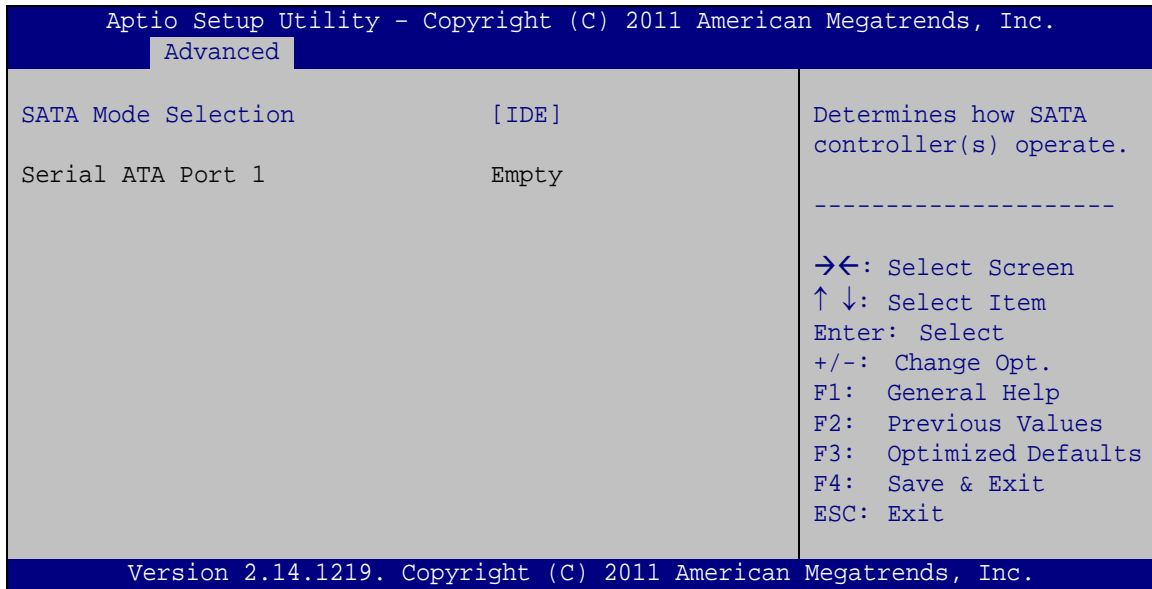
**BIOS Menu 6: SATA Configuration**

→ SATA Mode Selection [IDE]

Use the **SATA Mode Selection** option to configure SATA devices as normal IDE devices.

- **IDE** **DEFAULT** Configures SATA devices as normal IDE device.
- **AHCI** Configures SATA devices as AHCI device.
- **RAID** Configures SATA devices as RAID device.

4.3.5 Intel(R) Rapid Start Technology

Use the **Intel(R) Rapid Start Technology** menu (**BIOS Menu 7**) to configure Intel Rapid Start Technology support.



BIOS Menu 7: Intel(R) Rapid Start Technology

4.3.6 USB Configuration

Use the **USB Configuration** menu (**BIOS Menu 8**) to read USB configuration information and configure the USB settings.

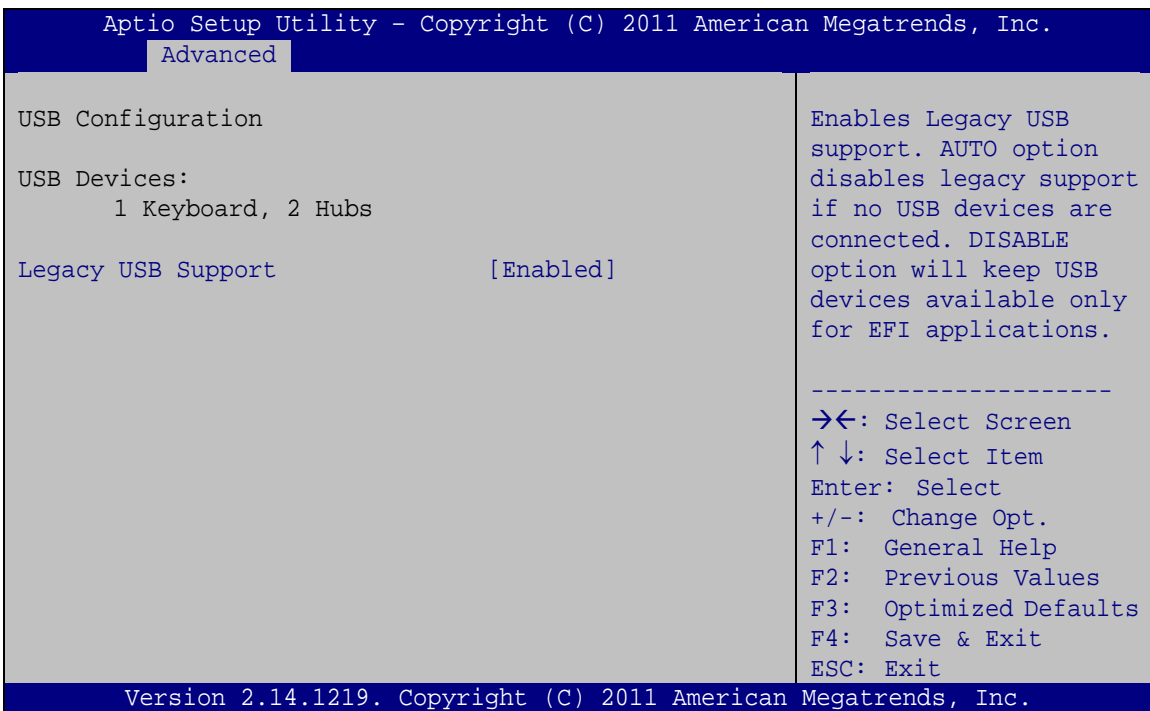

BIOS Menu 8: USB Configuration

UPC-V315-QM77 Panel PC

➔ USB Devices

The **USB Devices** field lists the USB devices that are enabled on the system

➔ Legacy USB Support [Enabled]

Use the **Legacy USB Support** BIOS option to enable USB mouse and USB keyboard support. Normally if this option is not enabled, any attached USB mouse or USB keyboard does not become available until a USB compatible operating system is fully booted with all USB drivers loaded. When this option is enabled, any attached USB mouse or USB keyboard can control the system even when there is no USB driver loaded onto the system.

- ➔ **Enabled** **DEFAULT** Legacy USB support enabled
- ➔ **Disabled** Legacy USB support disabled
- ➔ **Auto** Legacy USB support disabled if no USB devices are connected

4.3.7 F81866 Super IO Configuration

Use the **F81866 Super IO Configuration** menu (**BIOS Menu 9**) to set or change the configurations for the parallel ports and serial ports.

```

Aptio Setup Utility - Copyright (C) 2011 American Megatrends, Inc.
  Advanced
F81866 Super IO Configuration
F81866 Super IO Chip          F81866
> Serial Port 1 Configuration
> Serial Port 2 Configuration
> Serial Port 3 Configuration
> Serial Port 4 Configuration

Set Parameters of Serial
Port 1 (COMA)
-----
-><: Select Screen
↑↓: Select Item
Enter: Select
+/-: Change Opt.
F1: General Help
F2: Previous Values
F3: Optimized Defaults
F4: Save & Exit
ESC: Exit

Version 2.14.1219. Copyright (C) 2011 American Megatrends, Inc.
  
```

BIOS Menu 9: F81866 Super IO Configuration

4.3.7.1 Serial Port n Configuration

Use the **Serial Port n Configuration** menu (**BIOS Menu 10**) to configure the serial port n.

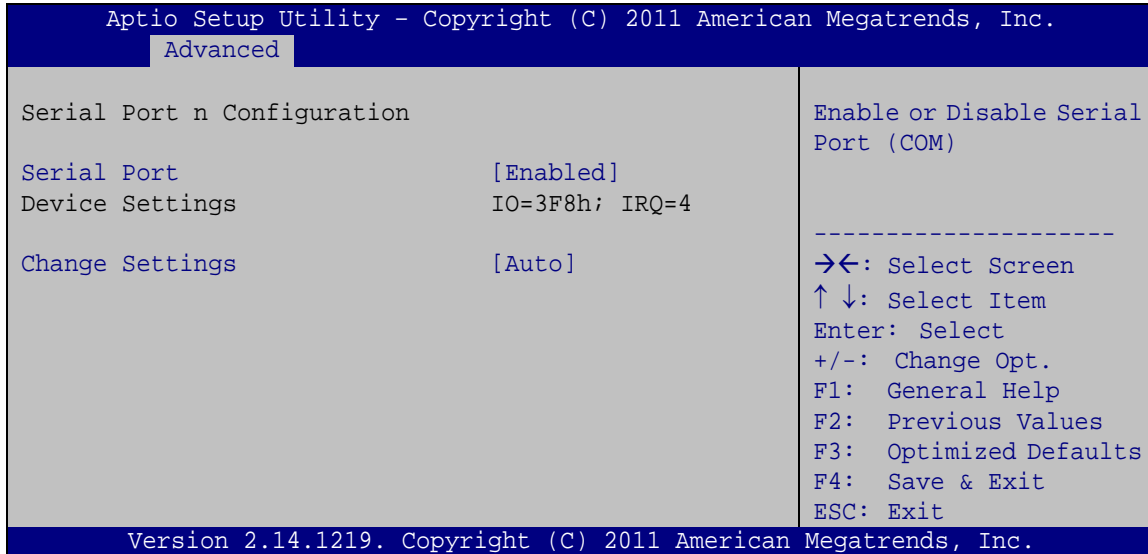

BIOS Menu 10: Serial Port n Configuration Menu

4.3.7.1.1 Serial Port 1 Configuration

→ Serial Port [Enabled]

Use the **Serial Port** option to enable or disable the serial port.

- **Disabled** Disable the serial port
- **Enabled** **DEFAULT** Enable the serial port

→ Change Settings [Auto]

Use the **Change Settings** option to change the serial port IO port address and interrupt address.

- **Auto** **DEFAULT** The serial port IO port address and interrupt address are automatically detected.
- **IO=3F8h;**
IRQ=4 Serial Port I/O port address is 3F8h and the interrupt address is IRQ4

UPC-V315-QM77 Panel PC

- ➔ **IO=3F8h;** Serial Port I/O port address is 3F8h and the interrupt
IRQ=3, 4 address is IRQ3, 4
- ➔ **IO=2F8h;** Serial Port I/O port address is 2F8h and the interrupt
IRQ=3, 4 address is IRQ3, 4

4.3.7.1.2 Serial Port 2 Configuration

- ➔ Serial Port [Enabled]

Use the **Serial Port** option to enable or disable the serial port.

- ➔ **Disabled** Disable the serial port
- ➔ **Enabled** **DEFAULT** Enable the serial port

- ➔ Change Settings [Auto]

Use the **Change Settings** option to change the serial port IO port address and interrupt address.

- ➔ **Auto** **DEFAULT** The serial port IO port address and interrupt address
are automatically detected.
- ➔ **IO=2F8h;** Serial Port I/O port address is 2F8h and the interrupt
IRQ=4 address is IRQ4
- ➔ **IO=3F8h;** Serial Port I/O port address is 3F8h and the interrupt
IRQ=3, 4 address is IRQ3, 4
- ➔ **IO=2F8h;** Serial Port I/O port address is 2F8h and the interrupt
IRQ=3, 4 address is IRQ3, 4

4.3.7.1.3 Serial Port 3 Configuration

- ➔ Serial Port [Enabled]

Use the **Serial Port** option to enable or disable the serial port.

- ➔ **Disabled** Disable the serial port

→ **Enabled** **DEFAULT** Enable the serial port

→ Change Settings [Auto]

Use the **Change Settings** option to change the serial port IO port address and interrupt address.

→ **Auto** **DEFAULT** The serial port IO port address and interrupt address are automatically detected.

→ **IO=2E0h;**
IRQ=5 Serial Port I/O port address is 2E0h and the interrupt address is IRQ5

→ **IO=2E0h;**
IRQ=5, 7 Serial Port I/O port address is 2E0h and the interrupt address is IRQ5, 7

→ **IO=2E8h;**
IRQ=5, 7 Serial Port I/O port address is 2E8h and the interrupt address is IRQ5, 7

4.3.7.1.4 Serial Port 4 Configuration

→ Serial Port [Enabled]

Use the **Serial Port** option to enable or disable the serial port.

→ **Disabled** Disable the serial port

→ **Enabled** **DEFAULT** Enable the serial port

→ Change Settings [Auto]

Use the **Change Settings** option to change the serial port IO port address and interrupt address.

→ **Auto** **DEFAULT** The serial port IO port address and interrupt address are automatically detected.

→ **IO=2E8h;**
IRQ=7 Serial Port I/O port address is 2E8h and the interrupt address is IRQ7

UPC-V315-QM77 Panel PC

- ➔ **IO=2E0h;** Serial Port I/O port address is 2E0h and the interrupt address is IRQ5, 7
IRQ=5, 7
- ➔ **IO=2E8h;** Serial Port I/O port address is 2E8h and the interrupt address is IRQ5, 7
IRQ=5, 7
- ➔ Device Mode [RS485/RS422]

The **Device Mode** shows Serial Port 4 provides RS-485/RS-422 communications.

4.3.8 H/W Monitor

The H/W Monitor menu (**BIOS Menu 11**) shows the operating temperature, fan speeds and system voltages.

```

Aptio Setup Utility - Copyright (C) 2011 American Megatrends, Inc.
Advanced
PC Health Status
CPU Temperature           :+50 C
Accuracy: 1.(-5~+10)degree around 100 degree
                2.(-10~+15)degree around 50 degree
System Temperature       :+41 C
V_CORE                   :+0.808 V
V_5S                     :+5.129 V
V_12S                   :+11.968 V
V_1.5V                   :+1.600 V
VSB5V                    :+5.136 V
VCC3V                    :+3.344 V
VSB3V                    :+3.360 V
-----
<->: Select Screen
↑ ↓: Select Item
Enter>Select
F1   General Help
F2   Previous Values
F3   Optimized Defaults
F4   Save
ESC  Exit
Version 2.14.1219. Copyright (C) 2011 American Megatrends, Inc.
    
```

BIOS Menu 11: Hardware Health Configuration

- ➔ PC Health Status

The following system parameters and values are shown. The system parameters that are monitored are:

- Temperatures:
 - CPU Temperature

- System Temperature
- Voltages:
 - V_CORE
 - V_5S
 - V_12S
 - V_1.5V
 - VSB5V
 - VCC3V
 - VSB3V

4.3.9 Serial Port Console Redirection

The **Serial Port Console Redirection** menu (**BIOS Menu 12**) allows the console redirection options to be configured. Console redirection allows users to maintain a system remotely by re-directing keyboard input and text output through the serial port.

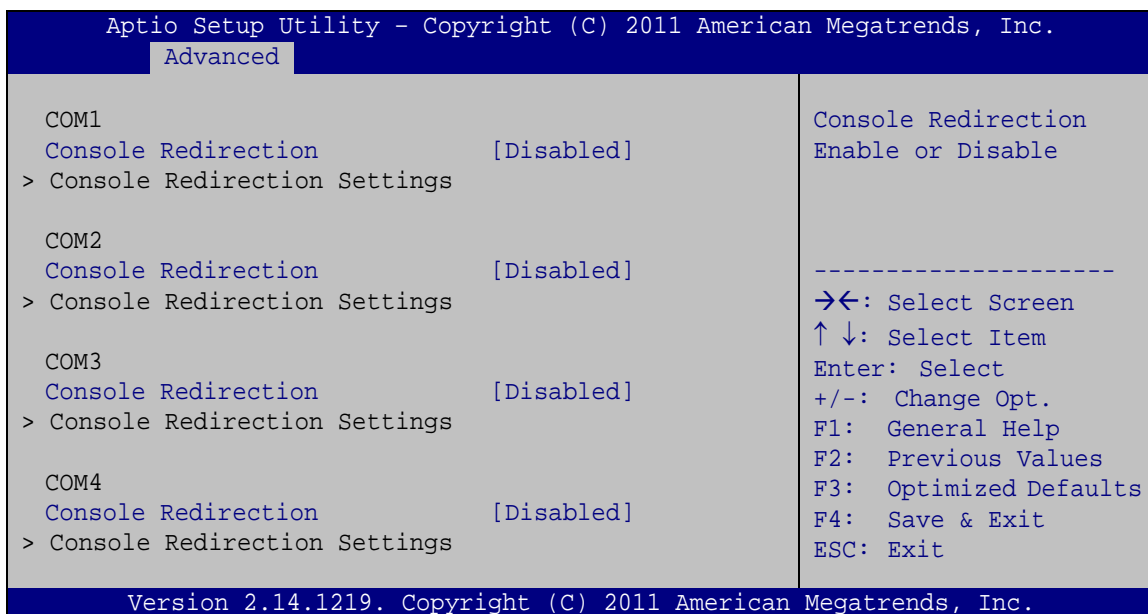

BIOS Menu 12: Serial Port Console Redirection

➔ Console Redirection [Disabled]

Use **Console Redirection** option to enable or disable the console redirection function.

➔ **Disabled** **DEFAULT** Disabled the console redirection function

UPC-V315-QM77 Panel PC

➔ **Enabled** Enabled the console redirection function

➔ Terminal Type [ANSI]

Use the **Terminal Type** option to specify the remote terminal type.

➔ **VT100** The target terminal type is VT100

➔ **VT100+** The target terminal type is VT100+

➔ **VT-UTF8** The target terminal type is VT-UTF8

➔ **ANSI** **DEFAULT** The target terminal type is ANSI

➔ Bits per second [115200]

Use the **Bits per second** option to specify the serial port transmission speed. The speed must match the other side. Long or noisy lines may require lower speeds.

➔ **9600** Sets the serial port transmission speed at 9600.

➔ **19200** Sets the serial port transmission speed at 19200.

➔ **38400** Sets the serial port transmission speed at 38400.

➔ **57600** Sets the serial port transmission speed at 57600.

➔ **115200** **DEFAULT** Sets the serial port transmission speed at 115200.

➔ Data Bits [8]

Use the **Data Bits** option to specify the number of data bits.

➔ **7** Sets the data bits at 7.

➔ **8** **DEFAULT** Sets the data bits at 8.

➔ Parity [None]

Use the **Parity** option to specify the parity bit that can be sent with the data bits for detecting the transmission errors.

- **None** **DEFAULT** No parity bit is sent with the data bits.
- **Even** The parity bit is 0 if the number of ones in the data bits is even.
- **Odd** The parity bit is 0 if the number of ones in the data bits is odd.
- **Mark** The parity bit is always 1. This option does not provide error detection.
- **Space** The parity bit is always 0. This option does not provide error detection.

→ Stop Bits [1]

Use the **Stop Bits** option to specify the number of stop bits used to indicate the end of a serial data packet. Communication with slow devices may require more than 1 stop bit.

- **1** **DEFAULT** Sets the number of stop bits at 1.
- **2** Sets the number of stop bits at 2.

4.3.10 iEi Feature

Use the **iEi Feature** menu (**BIOS Menu 13**) to configure One Key Recovery function.

UPC-V315-QM77 Panel PC

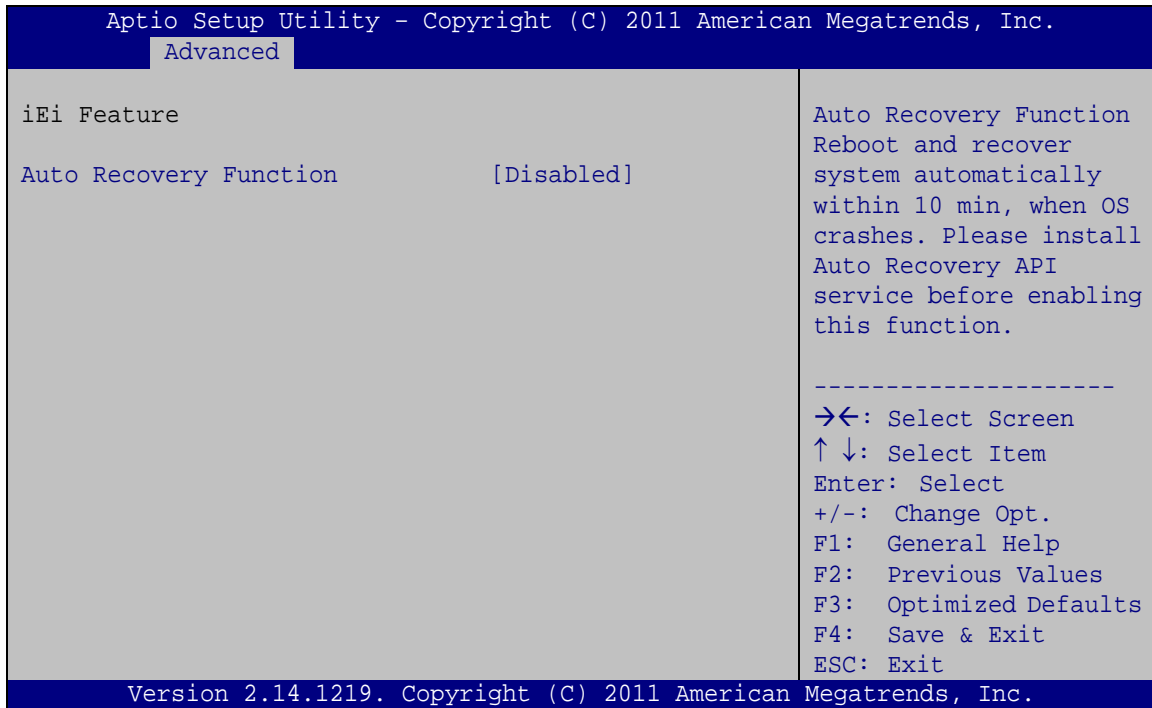

BIOS Menu 13: iEi Feature

→ Auto Recovery Function [Disabled]

Use the **Auto Recovery Function** BIOS option to enable or disable the auto recovery function of the IEI One Key Recovery.

- **Disabled** **DEFAULT** Auto recovery function disabled
- **Enabled** Auto recovery function enabled

4.4 Chipset

Use the **Chipset** menu (**BIOS Menu 14**) to access the PCH IO and System Agent (SA) configuration menus.



WARNING!

Setting the wrong values for the Chipset BIOS selections in the Chipset BIOS menu may cause the system to malfunction.

```

Aptio Setup Utility - Copyright (C) 2011 American Megatrends, Inc.
Main   Advanced  Chipset  Boot   Security  Save & Exit
-----
> PCH-IO Configuration
> System Agent (SA) Configuration

PCH Parameters
-----
-><: Select Screen
↑↓: Select Item
Enter: Select
+/-: Change Opt.
F1: General Help
F2: Previous Values
F3: Optimized Defaults
F4: Save & Exit
ESC: Exit

Version 2.14.1219. Copyright (C) 2011 American Megatrends, Inc.
    
```

BIOS Menu 14: Chipset

UPC-V315-QM77 Panel PC

4.4.1 PCH-IO Configuration

Use the **PCH-IO Configuration** menu (**BIOS Menu 15**) to configure the PCH parameters.

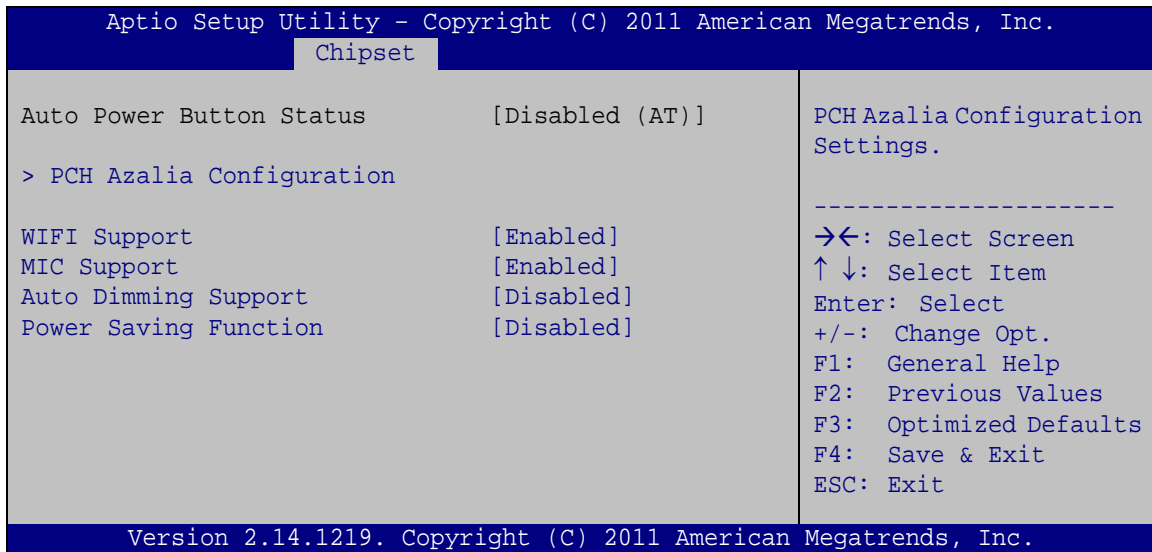

BIOS Menu 15: PCH-IO Configuration

→ WIFI Support [Enabled]

Use the **WIFI Support** option to enable or disable the Wi-Fi function.

- **Enabled** **DEFAULT** Enables Wi-Fi function
- **Disabled** Disables Wi-Fi function

→ MIC Support [Enabled]

Use the **MIC Support** option to enable or disable the microphone.

- **Enabled** **DEFAULT** Enables microphone
- **Disabled** Disables microphone

→ Auto Dimming Support [Disabled]

Use the **Auto Dimming Support** option to enable or disable the auto dimming function.

- **Enabled** Enables auto dimming function

➔ **Disabled** **DEFAULT** Disables auto dimming function

➔ Power Saving Function [Disabled]

Use the **Power Saving Function** BIOS option to enable or disable the power saving function.

➔ **Enabled** Power saving function is enabled. It will reduce power consumption when the system is off.

➔ **Disabled** **DEFAULT** Power saving function is disabled.

4.4.1.1 PCH Azalia Configuration

Use the **PCH Azalia Configuration** menu (**BIOS Menu 16**) to configure the PCH Azalia settings.

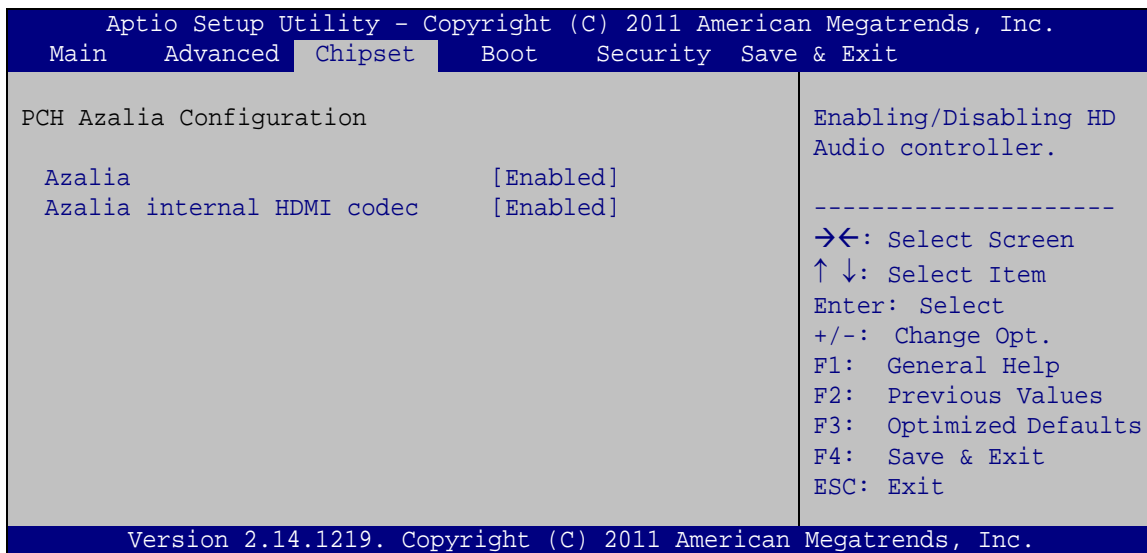

BIOS Menu 16: PCH Azalia Configuration Menu

➔ Azalia [Enabled]

Use the **Azalia** option to enable or disable the High Definition Audio controller.

➔ **Disabled** The onboard High Definition Audio controller is disabled

➔ **Enabled** **DEFAULT** The onboard High Definition Audio controller automatically detected and enabled

UPC-V315-QM77 Panel PC

➔ Azalia internal HDMI codec [Enabled]

Use the **Azalia internal HDMI codec** option to enable or disable the internal HDMI codec for High Definition Audio.

- ➔ **Disabled** Disables the internal HDMI codec for High Definition Audio
- ➔ **Enabled** **DEFAULT** Enables the internal HDMI codec for High Definition Audio

4.4.2 System Agent (SA) Configuration

Use the **System Agent (SA) Configuration** menu (**BIOS Menu 17**) to configure the System Agent (SA) parameters.

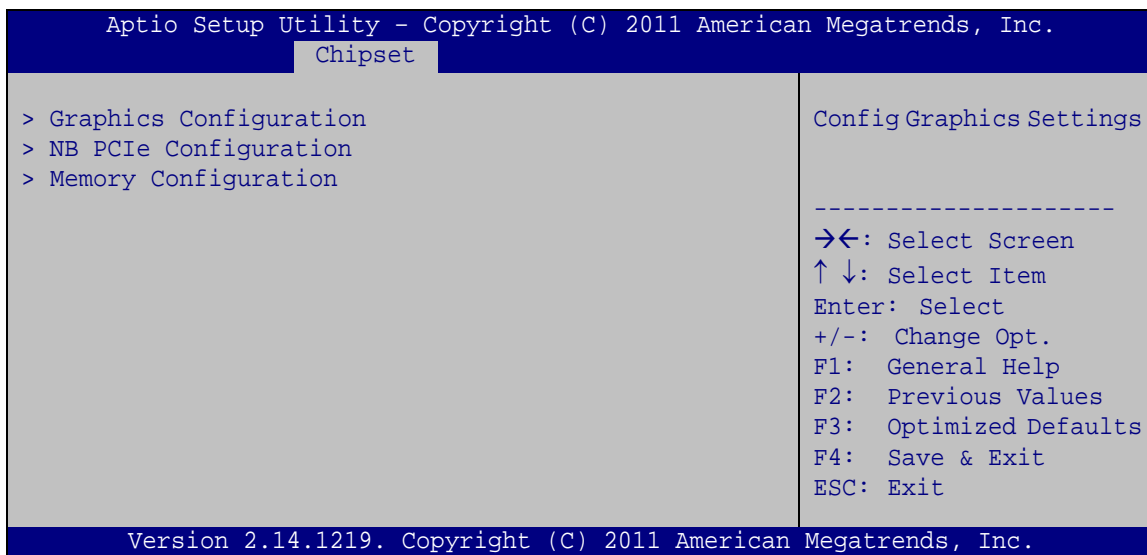

BIOS Menu 17: System Agent (SA) Configuration

4.4.2.1 Graphics Configuration

Use the **Graphics Configuration (BIOS Menu 18)** menu to configure the video device connected to the system.

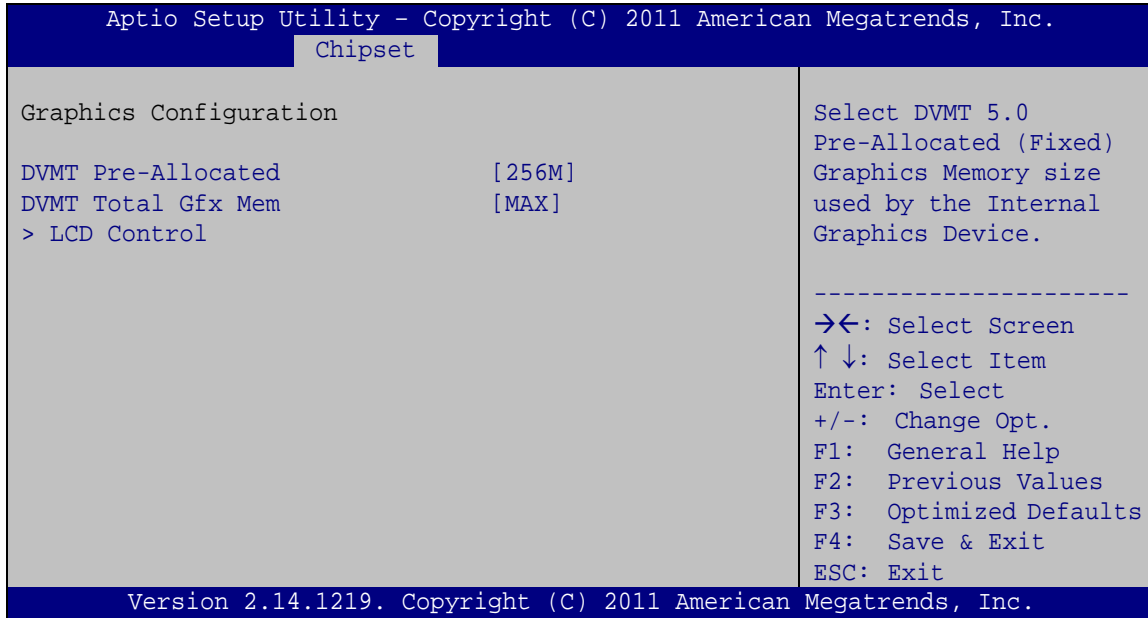

BIOS Menu 18: Graphics Configuration

→ DVMT Pre-Allocated [256M]

Use the **DVMT Pre-Allocated** option to set the amount of system memory allocated to the integrated graphics processor when the system boots. The system memory allocated can then only be used as graphics memory, and is no longer available to applications or the operating system. Configuration options are listed below:

- 32M
- 64M
- 128M
- 256M **Default**
- 512M

→ DVMT Total Gfx Mem [MAX]

Use the **DVMT Total Gfx Mem** option to select DVMT5.0 total graphic memory size used by the internal graphic device. The following options are available:

- 128M
- 256M
- MAX **Default**

UPC-V315-QM77 Panel PC

4.4.2.1.1 LCD Control

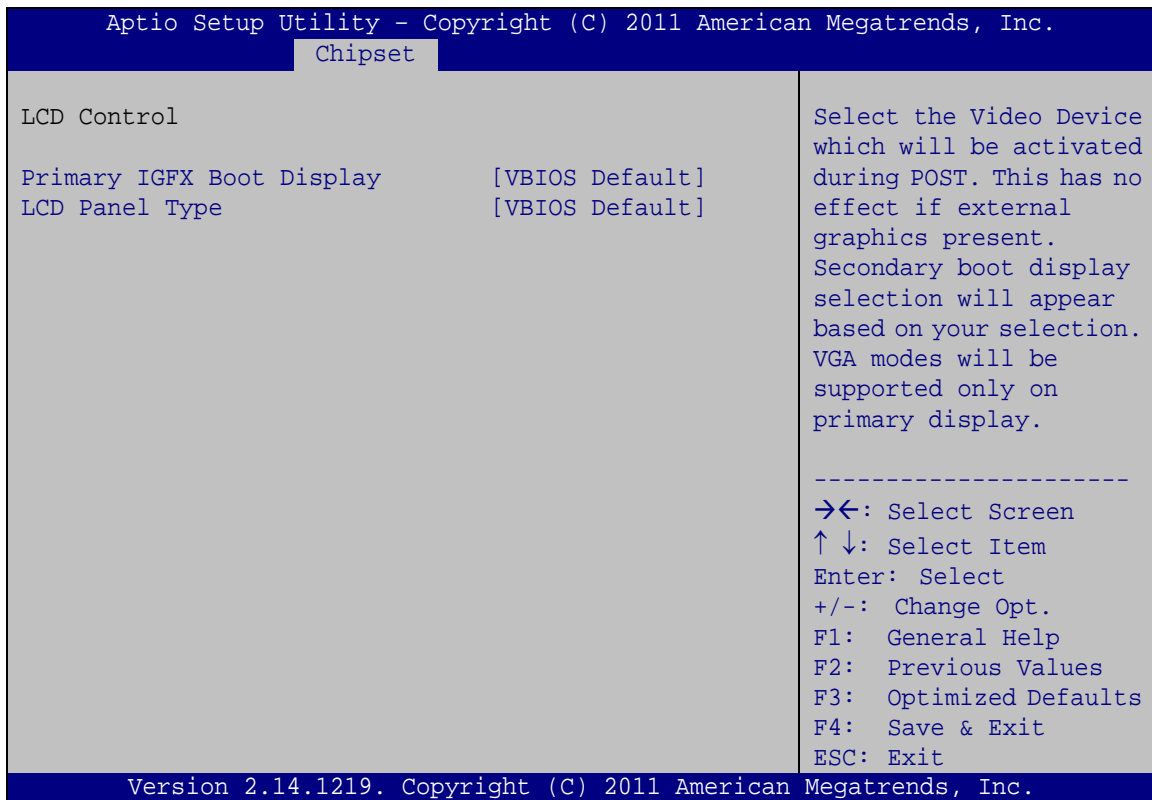

BIOS Menu 19: LCD Control

→ Primary IGFX Boot Display [VBIOS]

Use the **Primary IGFX Boot Display** option to select the display device used by the system when it boots. Configuration options are listed below.

- VBIOS **DEFAULT**
- CRT
- HDMI
- LVDS

→ LCD Panel Type [VBIOS]

Use the **LCD Panel Type** option to select the type of flat panel connected to the system. Configuration options are listed below.

- VBIOS **DEFAULT**
- 640x480 LVDS

- 800x600 LVDS
- 1024x768 LVDS1
- 1280x1024 LVDS
- 1400x1050(RB) LVDS1
- 1400x1050 LVDS2
- 1600x1200 LVDS
- 1366x768 LVDS
- 1680x1050 LVDS
- 1920x1200 LVDS
- 1440x900 LVDS
- 1600x1200 LVDS
- 1024x768 LVDS2
- 1280x800 LVDS
- 1920x1080 LVDS
- 2048x1536 LVDS

4.4.2.2 NB PCIe Configuration

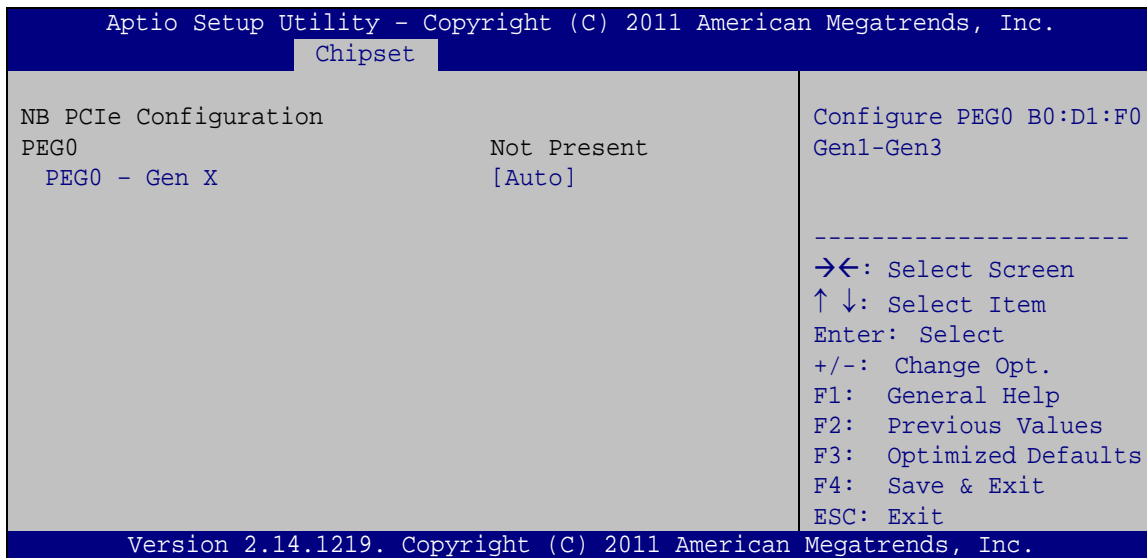

BIOS Menu 20: NB PCIe Configuration

→ PEG0 - Gen X [Auto]

Use the **PEG0 - Gen X** option to select the support type of the PCI Express (PEG) controller. The following options are available:

UPC-V315-QM77 Panel PC

- Auto **Default**
- Gen1
- Gen2
- Gen3

4.4.2.3 Memory Configuration

Use the **Memory Configuration** submenu (**BIOS Menu 21**) to view memory information.

```

Aptio Setup Utility - Copyright (C) 2011 American Megatrends, Inc.
Chipset
Memory Information
Memory Frequency          1333 MHz
Total Memory              2048 MB(DDR3)
Memory Slot               Not Present
Onboard Memory            2048 MB(DDR3)

-----
-><: Select Screen
↑ ↓: Select Item
Enter: Select
+/-: Change Opt.
F1: General Help
F2: Previous Values
F3: Optimized Defaults
F4: Save & Exit
ESC: Exit

Version 2.14.1219. Copyright (C) 2011 American Megatrends, Inc.

```

BIOS Menu 21: Memory Configuration

4.5 Boot

Use the **Boot** menu (**BIOS Menu 22**) to configure system boot options.

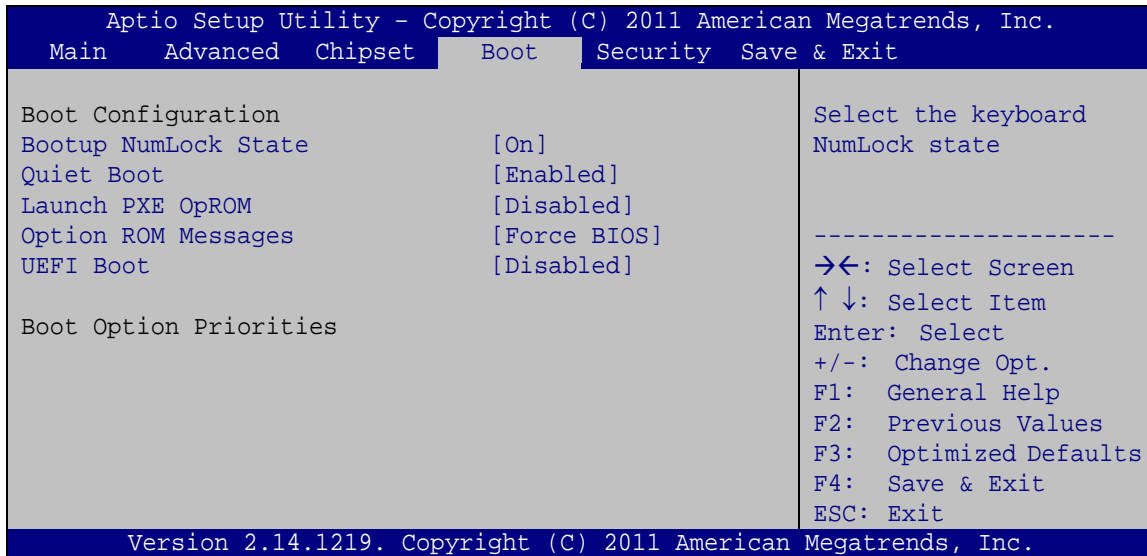

BIOS Menu 22: Boot

→ Bootup NumLock State [On]

Use the **Bootup NumLock State** BIOS option to specify if the number lock setting must be modified during boot up.

→ **On** **DEFAULT** Allows the Number Lock on the keyboard to be enabled automatically when the computer system boots up. This allows the immediate use of the 10-key numeric keypad located on the right side of the keyboard. To confirm this, the Number Lock LED light on the keyboard is lit.

→ **Off** Does not enable the keyboard Number Lock automatically. To use the 10-keys on the keyboard, press the Number Lock key located on the upper left-hand corner of the 10-key pad. The Number Lock LED on the keyboard lights up when the Number Lock is engaged.

UPC-V315-QM77 Panel PC

→ Quiet Boot [Enabled]

Use the **Quiet Boot** BIOS option to select the screen display when the system boots.

- **Disabled** Normal POST messages displayed
- **Enabled** **DEFAULT** OEM Logo displayed instead of POST messages

→ Launch PXE OpROM [Disabled]

Use the **Launch PXE OpROM** option to enable or disable boot option for legacy network devices.

- **Disabled** **DEFAULT** Ignore all PXE Option ROMs
- **Enabled** Load PXE Option ROMs.

→ Option ROM Messages [Force BIOS]

Use the **Option ROM Messages** option to set the Option ROM display mode.

- **Force BIOS** **DEFAULT** Sets display mode to force BIOS.
- **Keep Current** Sets display mode to current.

→ UEFI Boot [Disabled]

Use the **UEFI Boot** option to enable or disable to boot from the UEFI devices.

- **Enabled** Boot from UEFI devices is enabled.
- **Disabled** **DEFAULT** Boot from UEFI devices is disabled.

4.6 Security

Use the **Security** menu (**BIOS Menu 23**) to set system and user passwords.

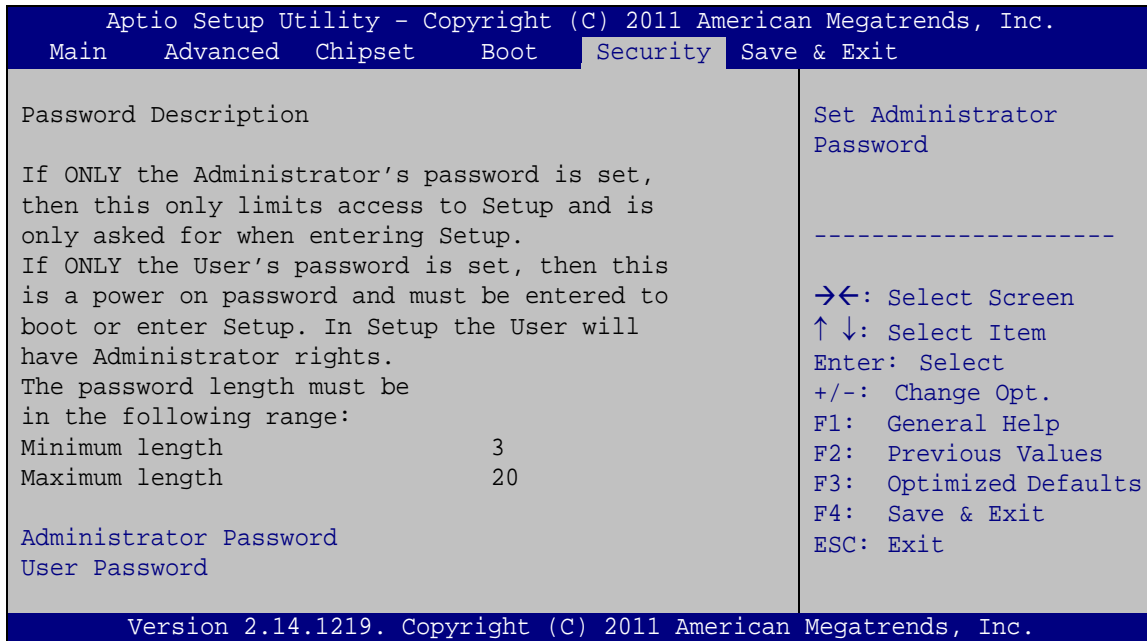

BIOS Menu 23: Security

→ Administrator Password

Use the **Administrator Password** to set or change a administrator password.

→ User Password

Use the **User Password** to set or change a user password.

4.7 Save & Exit

Use the **Safe & Exit** menu (**BIOS Menu 24**) to load default BIOS values, optimal failsafe values and to save configuration changes.

```

Aptio Setup Utility - Copyright (C) 2011 American Megatrends, Inc.
Main   Advanced  Chipset   Boot     Security  Save & Exit
-----
Save Changes and Reset
Discard Changes and Reset

Restore Defaults
Save as User Defaults
Restore User Defaults

Exit the system after
saving the changes.

-----
-><: Select Screen
↑ ↓: Select Item
Enter: Select
+/-: Change Opt.
F1:  General Help
F2:  Previous Values
F3:  Optimized Defaults
F4:  Save & Exit
ESC: Exit

Version 2.14.1219. Copyright (C) 2011 American Megatrends, Inc.

```

BIOS Menu 24: Save & Exit

→ Save Changes and Reset

Use the **Save Changes and Reset** option to save the changes made to the BIOS options and reset the system.

→ Discard Changes and Reset

Use the **Discard Changes and Reset** option to exit the system without saving the changes made to the BIOS configuration setup program.

→ Restore Defaults

Use the **Restore Defaults** option to load the optimal default values for each of the parameters on the Setup menus. **F3 key can be used for this operation.**

➔ Save as User Defaults

Use the **Save as User Defaults** option to save the changes done so far as user defaults.

➔ Restore User Defaults

Use the **Restore User Defaults** option to restore the user defaults to all the setup options.

Appendix

A

BIOS Menu Options

- ➔ System Overview52
- ➔ System Date [xx/xx/xx]52
- ➔ System Time [xx:xx:xx]52
- ➔ ACPI Sleep State [S1 (CPU Stop Clock)]54
- ➔ Wake system with Fixed Time [Disabled].....55
- ➔ Hyper-threading [Enabled].....56
- ➔ Intel Virtualization Technology [Disabled]56
- ➔ SATA Mode Selection [IDE]57
- ➔ USB Devices59
- ➔ Legacy USB Support [Enabled].....59
- ➔ Serial Port [Enabled].....60
- ➔ Change Settings [Auto]60
- ➔ Serial Port [Enabled].....61
- ➔ Change Settings [Auto]61
- ➔ Serial Port [Enabled].....61
- ➔ Change Settings [Auto]62
- ➔ Serial Port [Enabled].....62
- ➔ Change Settings [Auto]62
- ➔ Serial Port [Enabled].....62
- ➔ Change Settings [Auto]62
- ➔ Device Mode [RS485/RS422].....63
- ➔ PC Health Status63
- ➔ Console Redirection [Disabled].....64
- ➔ Terminal Type [ANSI].....65
- ➔ Bits per second [115200].....65
- ➔ Data Bits [8]65
- ➔ Parity [None].....65
- ➔ Stop Bits [1].....66
- ➔ Auto Recovery Function [Disabled]67
- ➔ WIFI Support [Enabled]69
- ➔ MIC Support [Enabled]69
- ➔ Auto Dimming Support [Disabled]69
- ➔ Power Saving Function [Disabled].....70
- ➔ Azalia [Enabled]70
- ➔ Azalia internal HDMI codec [Enabled]71
- ➔ DVMT Pre-Allocated [256M]72

UPC-V315-QM77 Panel PC

| | |
|---|----|
| → DVMT Total Gfx Mem [MAX]..... | 72 |
| → Primary IGFX Boot Display [VBIOS] | 73 |
| → LCD Panel Type [VBIOS] | 73 |
| → PEG0 – Gen X [Auto] | 74 |
| → Bootup NumLock State [On]..... | 76 |
| → Quiet Boot [Enabled] | 77 |
| → Launch PXE OpROM [Disabled] | 77 |
| → Option ROM Messages [Force BIOS]..... | 77 |
| → UEFI Boot [Disabled] | 77 |
| → Administrator Password | 78 |
| → User Password | 78 |
| → Save Changes and Reset | 79 |
| → Discard Changes and Reset | 79 |
| → Restore Defaults | 79 |
| → Save as User Defaults | 80 |
| → Restore User Defaults | 80 |

Appendix

B

One Key Recovery

B.1 One Key Recovery Introduction

The IEI one key recovery is an easy-to-use front end for the Norton Ghost system backup and recovery tool. This tool provides quick and easy shortcuts for creating a backup and reverting to that backup or reverting to the factory default settings.



NOTE:

The latest One Key Recovery software provides an auto recovery function that allows a system running Microsoft Windows OS to automatically restore from the factory default image after encountering a Blue Screen of Death (BSOD) or a hang for around 10 minutes. Please refer to Section B.3 for the detailed setup procedure.

The IEI One Key Recovery tool menu is shown below.

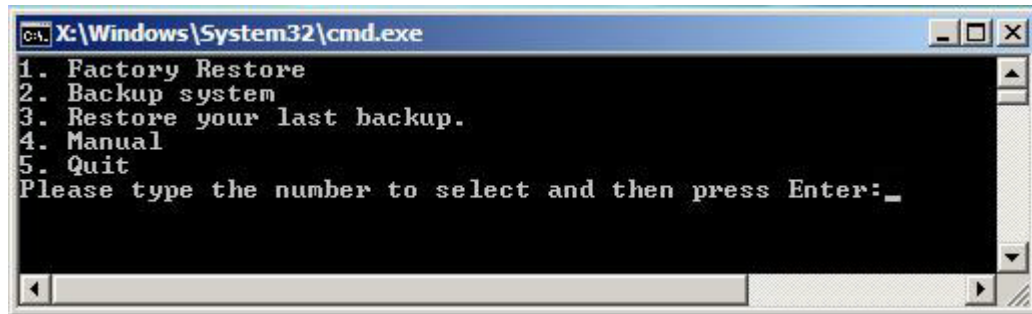

Figure B-1: IEI One Key Recovery Tool Menu

Prior to using the IEI One Key Recovery tool (as shown in **Figure B-1**) to backup or restore Windows system, five setup procedures are required.

3. Hardware and BIOS setup (see **Section B.2.1**)
4. Create partitions (see **Section B.2.2**)
5. Install operating system, drivers and system applications (see **Section B.2.3**)
6. Build the recovery partition (see **Section B.2.4**)
7. Create factory default image (see **Section B.2.5**)

After completing the five initial setup procedures as described above, users can access the recovery tool by pressing <F3> while booting up the system. The detailed information of each function is described in **Section B.5**.

**NOTE:**

The initial setup procedures for Linux system are described in **Section B.3**.

B.1.1 System Requirement

**NOTE:**

The recovery CD can only be used with IEI products. The software will fail to run and a warning message will appear when used on non-IEI hardware.

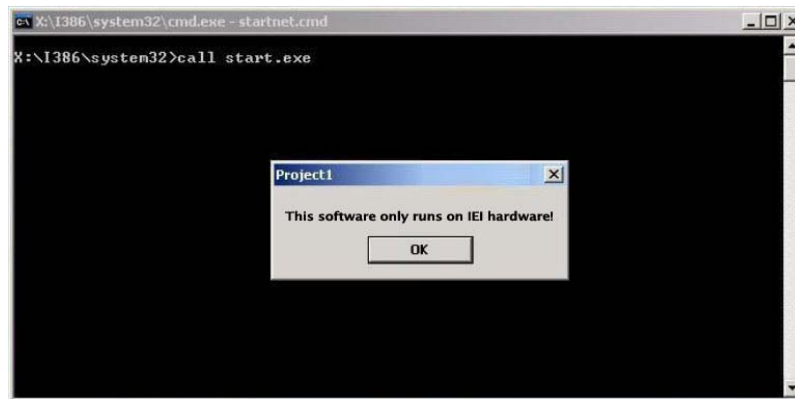

To create the system backup, the main storage device must be split into two partitions (three partitions for Linux). The first partition will be for the operating system, while the second partition will be invisible to the operating system and contain the backup made by the one key recovery software.

The partition created for recovery images must be big enough to contain both the factory default image and the user backup image. The size must be calculated before creating the

UPC-V315-QM77 Panel PC

partitions. Please take the following table as a reference when calculating the size of the partition.

| | OS | OS Image after Ghost | Compression Ratio |
|------------------------|--------|----------------------|-------------------|
| Windows® 7 | 7 GB | 5 GB | 70% |
| Windows® XPE | 776 MB | 560 MB | 70% |
| Windows® CE 6.0 | 36 MB | 28 MB | 77% |

**NOTE:**

Specialized tools are required to change the partition size if the operating system is already installed.

B.1.2 Supported Operating System

The recovery CD is compatible with both Microsoft Windows and Linux operating systems (OS). The supported OS versions are listed below.

- Microsoft Windows
 - Windows XP (Service Pack 2 or 3 required)
 - Windows Vista
 - Windows 7
 - Windows CE 5.0
 - Windows CE 6.0
 - Windows XP Embedded
- Linux
 - Fedora Core 12 (Constantine)
 - Fedora Core 11 (Leonidas)
 - Fedora Core 10 (Cambridge)
 - Fedora Core 8 (Werewolf)
 - Fedora Core 7 (Moonshine)
 - RedHat RHEL-5.4
 - RedHat 9 (Ghirke)

- Ubuntu 8.10 (Intrepid)
- Ubuntu 7.10 (Gutsy)
- Ubuntu 6.10 (Edgy)
- Debian 5.0 (Lenny)
- Debian 4.0 (Etch)
- SuSe 11.2
- SuSe 10.3

**NOTE:**

Installing unsupported OS versions may cause the recovery tool to fail.

B.2 Setup Procedure for Windows

Prior to using the recovery tool to backup or restore, a few setup procedures are required.

Step 4: Hardware and BIOS setup (see **Section B.2.1**)

Step 5: Create partitions (see **Section B.2.2**)

Step 6: Install operating system, drivers and system applications (see **Section B.2.3**)

Step 7: Build the recovery partition (see **Section B.2.4**) or build the auto recovery partition (see **Section B.3**)

Step 8: Create factory default image (see **Section B.2.5**)

The detailed descriptions are described in the following sections.

**NOTE:**

The setup procedures described below are for Microsoft Windows operating system users. For Linux, most of the setup procedures are the same except for several steps described in **Section B.3**.

UPC-V315-QM77 Panel PC

B.2.1 Hardware and BIOS Setup

- Step 1:** Make sure the system is powered off and unplugged.
- Step 2:** Install a hard drive or SSD in the system. An unformatted and unpartitioned disk is recommended.
- Step 3:** Connect an optical disk drive to the system and insert the recovery CD.
- Step 4:** Turn on the system.
- Step 5:** Press the <DELETE> key as soon as the system is turned on to enter the BIOS.
- Step 6:** Select the connected optical disk drive as the 1st boot device. (**Boot → Boot Device Priority → 1st Boot Device**).
- Step 7:** Save changes and restart the computer. Continue to the next section for instructions on partitioning the internal storage.

B.2.2 Create Partitions

To create the system backup, the main storage device must be split into two partitions (three partitions for Linux). The first partition will be for the operating system, while the second partition will be invisible to the operating system and contain the backup made by the one key recovery software.

- Step 1:** Put the recovery CD in the optical drive of the system.
- Step 2:** **Boot the system from recovery CD.** When prompted, press any key to boot from the recovery CD. It will take a while to launch the recovery tool. Please be patient!



Figure B-2: Launching the Recovery Tool

Step 3: The recovery tool setup menu is shown as below.

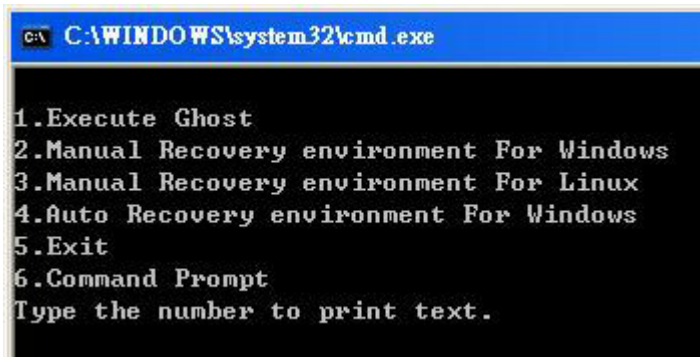
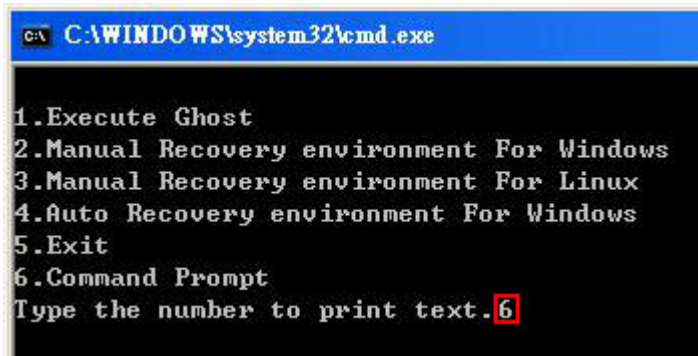

Figure B-3: Recovery Tool Setup Menu

Step 4: Press <6> then <Enter>.



```
C:\WINDOWS\system32\cmd.exe

1.Execute Ghost
2.Manual Recovery environment For Windows
3.Manual Recovery environment For Linux
4.Auto Recovery environment For Windows
5.Exit
6.Command Prompt
Type the number to print text. 6
```

Figure B-4: Command Prompt

Step 5: The command prompt window appears. Type the following commands (marked in red) to create two partitions. One is for the OS installation; the other is for saving recovery files and images which will be an invisible partition. (Press <Enter> after entering each line below)

```
system32>diskpart
DISKPART>list vol
DISKPART>sel disk 0
DISKPART>create part pri size= ____
DISKPART>assign letter=N
DISKPART>create part pri size= ____
DISKPART>assign letter=F
DISKPART>exit
system32>format N: /fs:ntfs /q /y
system32>format F: /fs:ntfs /q /v:Recovery /y
system32>exit
```

```

X:\I386\SYSTEM32\CMD.EXE
X:\I386\SYSTEM32>diskpart → Starts the Microsoft disk partitioning tool.
Microsoft DiskPart version 5.2.3790.1830
Copyright (C) 1999-2001 Microsoft Corporation.
On computer: MININT-JUC

DISKPART> list vol → Show partition information

   Volume ###  Ltr  Label          Fs          Type          Size         Status       Info
   -----  -
   Volume 0          X   CD_ROM         CDFS        DUD-ROM       405 MB       Healthy      Boot
   Volume 1          D                   FAT32      Removeable   3854 MB       Healthy

DISKPART> sel disk 0 → Select a disk
Disk 0 is now the selected disk.

DISKPART> create part pri size=2000 → Create partition 1 and assign a size.
                                     This partition is for OS installation.
DiskPart succeeded in creating the specified partition.

DISKPART> assign letter=N → Assign partition 1 a code name (N).
DiskPart successfully assigned the drive letter or mount point.

DISKPART> create part pri size=1800 → Create partition 2 and assign a size.
                                     This partition is for recovery images.
DiskPart succeeded in creating the specified partition.

DISKPART> assign letter=F → Assign partition 2 a code name (F).
DiskPart successfully assigned the drive letter or mount point.

DISKPART> exit → Exit diskpart

X:\I386\SYSTEM32>format n: /fs:ntfs /q /y → Format partition 1 (N) as NTFS format.
The type of the file system is RAW.
The new file system is NTFS.
QuickFormatting 2000M
Creating file system structures.
Format complete.
 2048254 KB total disk space.
 2035620 KB are available.

X:\I386\SYSTEM32>format f: /fs:ntfs /q /v:Recovery /y → Formate partition 2 (F) as NTFS formate and
                                                         name it as "Recovery".
The type of the file system is RAW.
The new file system is NTFS.
QuickFormatting 1804M
Creating file system structures.
Format complete.
 1847474 KB total disk space.
 1835860 KB are available.

X:\I386\SYSTEM32>exit → Exit Windows PE

```

Figure B-5: Partition Creation Commands

**NOTE:**

Use the following commands to check if the partitions were created successfully.

```
X:\I386\SYSTEM32>diskpart
Microsoft DiskPart version 5.2.3790.1830
Copyright (C) 1999-2001 Microsoft Corporation.
On computer: MININT-JUC

DISKPART> sel disk 0
Disk 0 is now the selected disk.

DISKPART> list part

   Partition ###   Type              Size              Offset
-----
Partition 1       Primary           2000 MB           32 KB
Partition 2       Primary           1804 MB          2000 MB

DISKPART> exit
```

Step 6: Press any key to exit the recovery tool and automatically reboot the system.

Please continue to the following procedure: Build the Recovery Partition.

B.2.3 Install Operating System, Drivers and Applications

Install the operating system onto the unlabelled partition. The partition labeled "Recovery" is for use by the system recovery tool and should not be used for installing the operating system or any applications.

**NOTE:**

The operating system installation program may offer to reformat the chosen partition. DO NOT format the partition again. The partition has already been formatted and is ready for installing the new operating system.

To install the operating system, insert the operating system installation CD into the optical drive. Restart the computer and follow the installation instructions.

B.2.4 Building the Recovery Partition

- Step 1:** Put the recover CD in the optical drive.
- Step 2:** Start the system.
- Step 3:** **Boot the system from the recovery CD.** When prompted, press any key to boot from the recovery CD. It will take a while to launch the recovery tool. Please be patient!

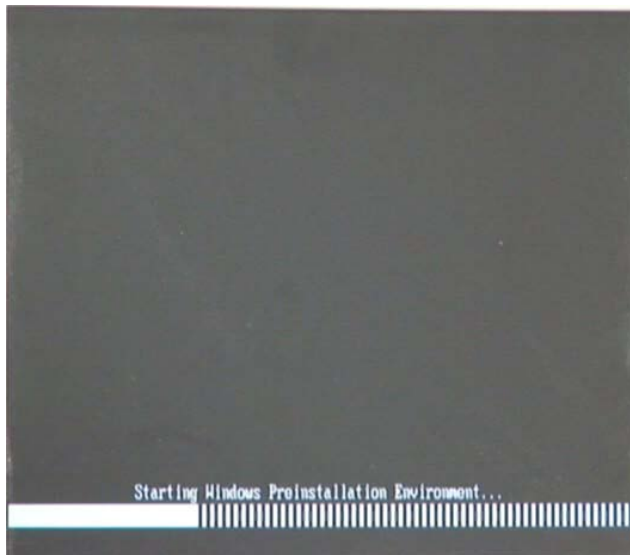

Figure B-6: Launching the Recovery Tool

- Step 4:** When the recovery tool setup menu appears, press <2> then <Enter>.

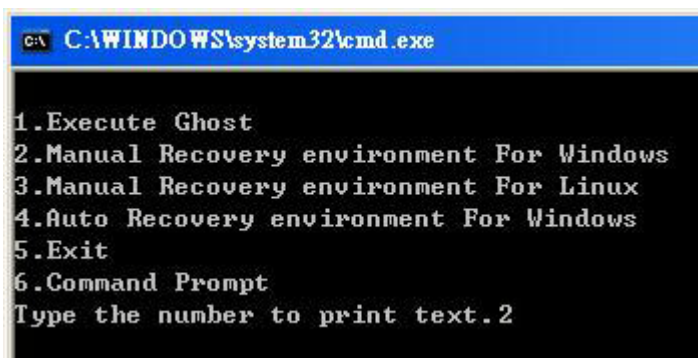

Figure B-7: Manual Recovery Environment for Windows

UPC-V315-QM77 Panel PC

Step 5: The Symantec Ghost window appears and starts configuring the system to build a recovery partition. In this process the partition created for recovery files in **Section B.2.2** is hidden and the recovery tool is saved in this partition.

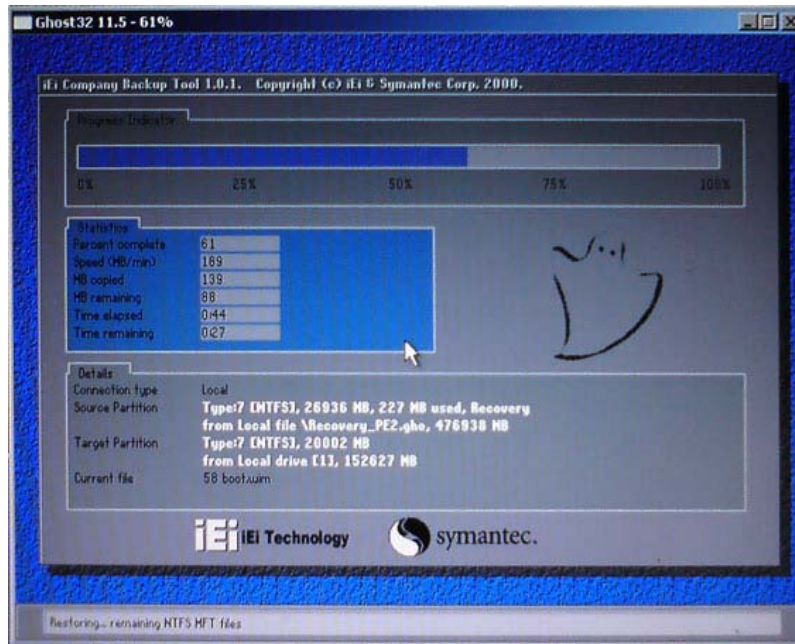

Figure B-8: Building the Recovery Partition

Step 6: After completing the system configuration, press any key in the following window to reboot the system.

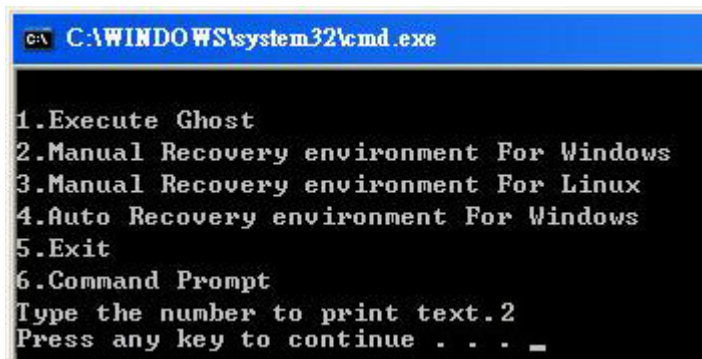

Figure B-9: Press Any Key to Continue

Step 7: Eject the recovery CD.

B.2.5 Create Factory Default Image



NOTE:

Before creating the factory default image, please configure the system to a factory default environment, including driver and application installations.

To create a factory default image, please follow the steps below.

Step 1: Turn on the system. When the following screen displays (**Figure B-10**), press the <F3> key to access the recovery tool. The message will display for 10 seconds, please press F3 before the system boots into the operating system.

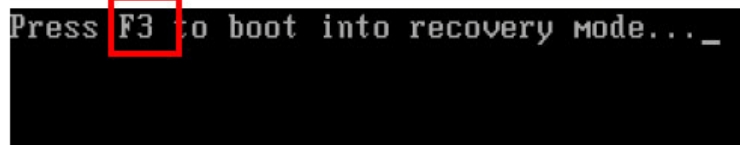

Figure B-10: Press F3 to Boot into Recovery Mode

Step 2: The recovery tool menu appears. Type <4> and press <Enter>. (**Figure B-11**)

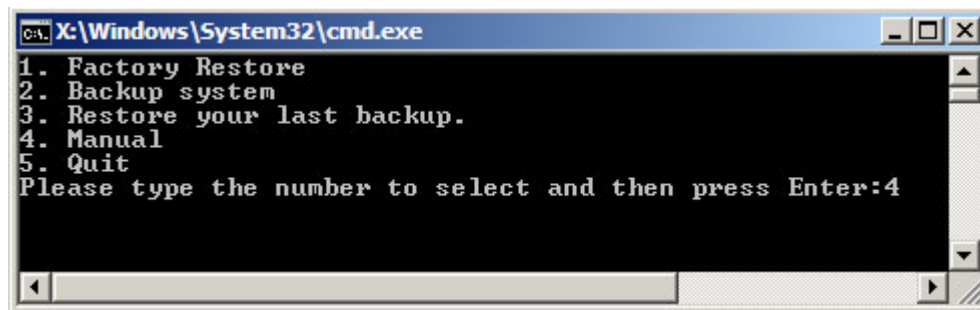

Figure B-11: Recovery Tool Menu

Step 3: The About Symantec Ghost window appears. Click **OK** button to continue.

UPC-V315-QM77 Panel PC

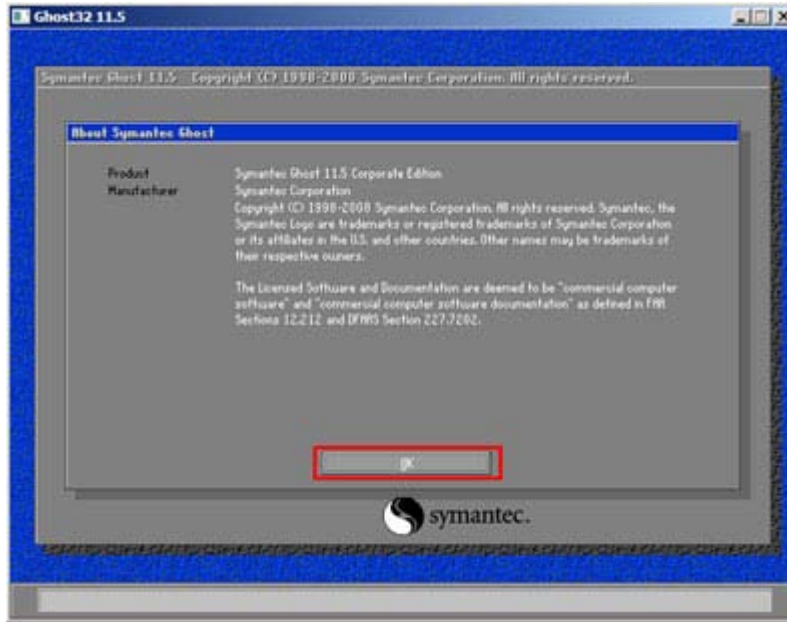

Figure B-12: About Symantec Ghost Window

Step 4: Use mouse to navigate to the option shown below (Figure B-13).

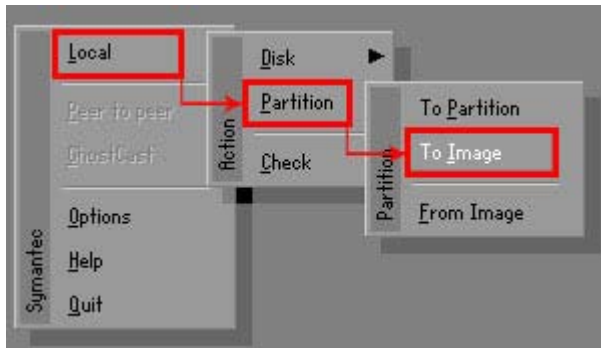

Figure B-13: Symantec Ghost Path

Step 5: Select the local source drive (Drive 1) as shown in Figure B-14. Then click OK.

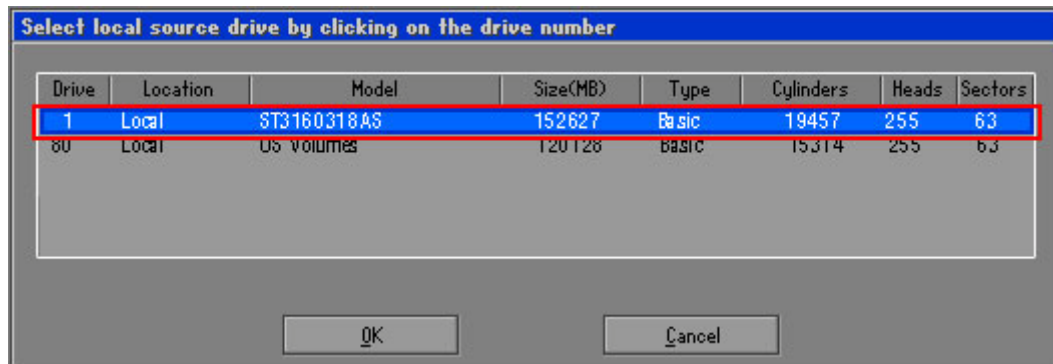

Figure B-14: Select a Local Source Drive

Step 6: Select a source partition (Part 1) from basic drive as shown in **Figure B-15**. Then click OK.

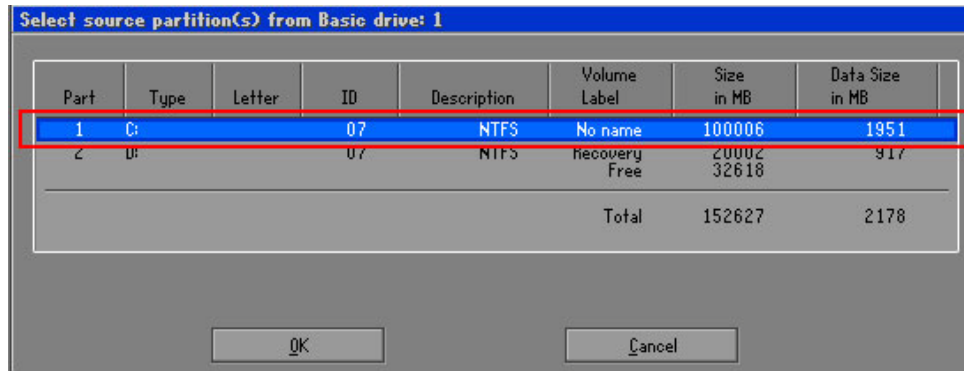

Figure B-15: Select a Source Partition from Basic Drive

Step 7: Select **1.2: [Recovery] NTFS drive** and enter a file name called **iei** (**Figure B-16**). Click **Save**. The factory default image will then be saved in the selected recovery drive and named **IEI.GHO**.



WARNING:

The file name of the factory default image must be **iei.GHO**.

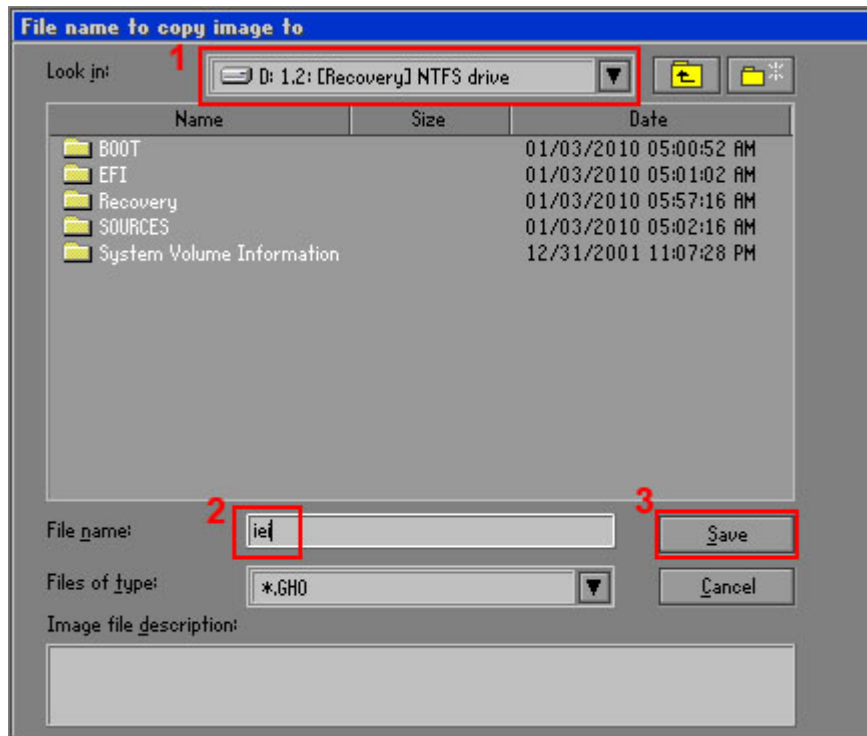

Figure B-16: File Name to Copy Image to

Step 8: When the Compress Image screen in **Figure B-17** prompts, click **High** to make the image file smaller.

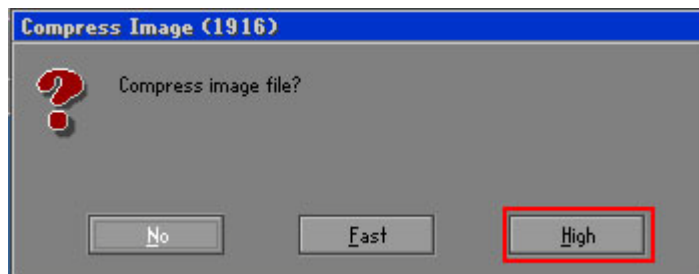

Figure B-17: Compress Image

Step 9: The Proceed with partition image creation window appears, click **Yes** to continue.

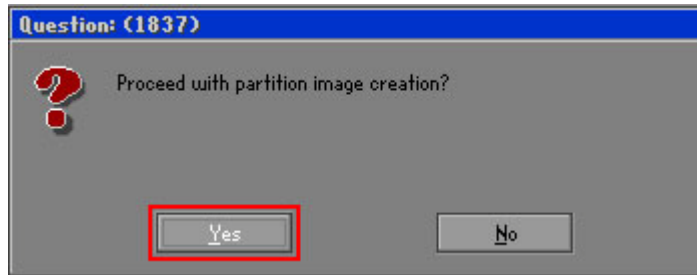

Figure B-18: Image Creation Confirmation

Step 10: The Symantec Ghost starts to create the factory default image (**Figure B-19**).

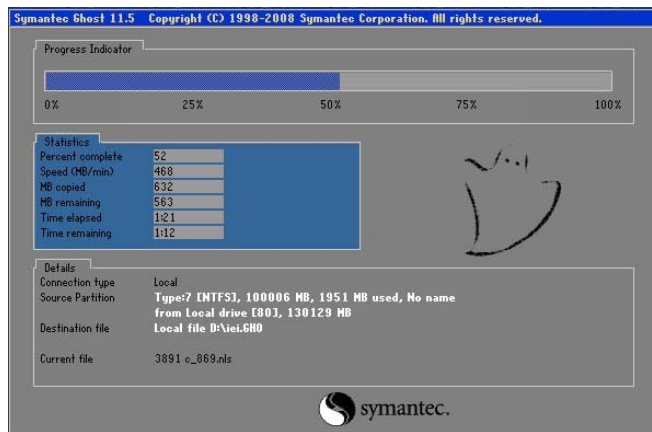

Figure B-19: Image Creation Complete

Step 11: When the image creation completes, a screen prompts as shown in **Figure B-20**. Click **Continue** and close the Ghost window to exit the program.

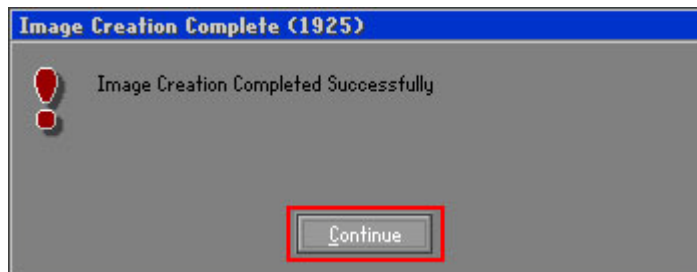

Figure B-20: Image Creation Complete

UPC-V315-QM77 Panel PC

Step 12: The recovery tool main menu window is shown as below. Press any key to reboot the system.

A screenshot of a Windows command prompt window. The title bar reads 'C:\Windows\System32\cmd.exe'. The window content shows a numbered menu: '1. Factory Restore', '2. Backup system', '3. Restore your last backup.', '4. Manual', and '5. Quit'. Below the menu, it says 'Please type the number to select and then press Enter:4'. At the bottom, it says 'Done!' and 'Press any key to continue . . . _'.

Figure B-21: Press Any Key to Continue

B.3 Auto Recovery Setup Procedure

The auto recovery function allows a system to automatically restore from the factory default image after encountering a Blue Screen of Death (BSoD) or a hang for around 10 minutes. To use the auto recovery function, follow the steps described in the following sections.

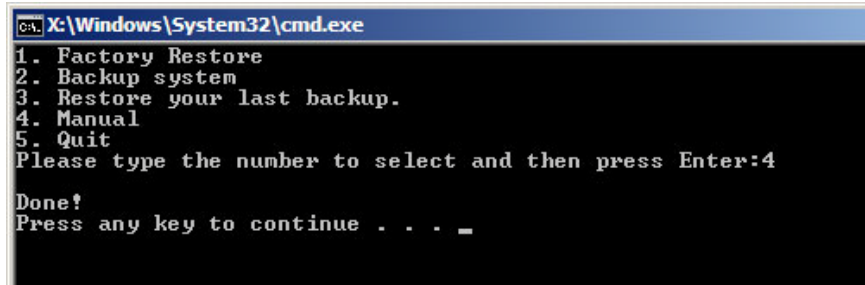

CAUTION:

The setup procedure may include a step to create a factory default image. It is suggested to configure the system to a factory default environment before the configuration, including driver and application installations.

Step 1: Follow the steps described in **Section B.2.1 ~ Section B.2.3** to setup BIOS, create partitions and install operating system.

Step 2: Install the auto recovery utility into the system by double clicking the **Utility/AUTORECOVERY-SETUP.exe** in the One Key Recovery CD. This utility **MUST** be installed in the system, otherwise, the system will automatically restore from the factory default image every ten (10) minutes.



Figure B-22: Auto Recovery Utility

Step 3: Reboot the system from the recovery CD. When prompted, press any key to boot from the recovery CD. It will take a while to launch the recovery tool. Please be patient!



Figure B-23: Launching the Recovery Tool

Step 4: When the recovery tool setup menu appears, press <4> then <Enter>.

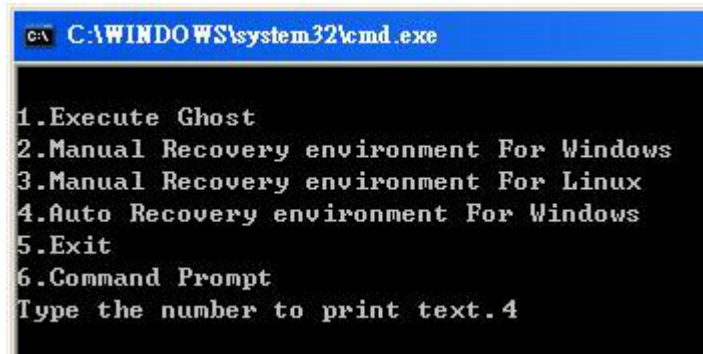

Figure B-24: Auto Recovery Environment for Windows

UPC-V315-QM77 Panel PC

- Step 5:** The Symantec Ghost window appears and starts configuring the system to build an auto recovery partition. In this process the partition created for recovery files in **Section B.2.2** is hidden and the auto recovery tool is saved in this partition.

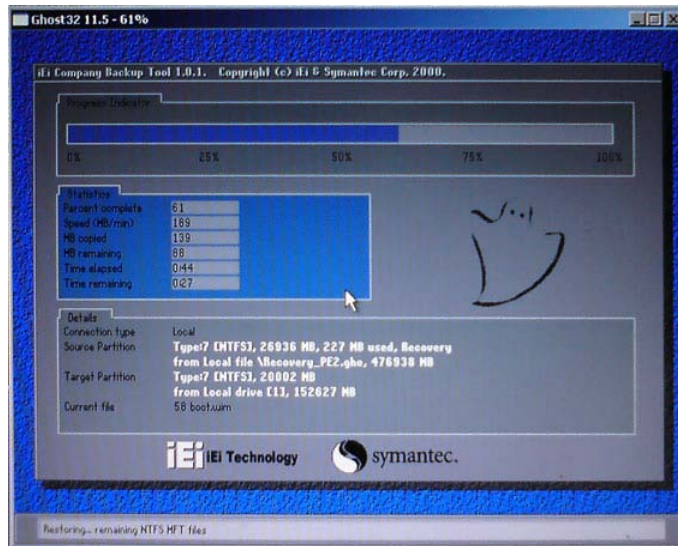

Figure B-25: Building the Auto Recovery Partition

- Step 6:** After completing the system configuration, the following message prompts to confirm whether to create a factory default image. Type **Y** to have the system create a factory default image automatically. Type **N** within 6 seconds to skip this process (The default option is YES). It is suggested to choose YES for this option.



Figure B-26: Factory Default Image Confirmation

Step 7: The Symantec Ghost starts to create the factory default image (**Figure B-27**).

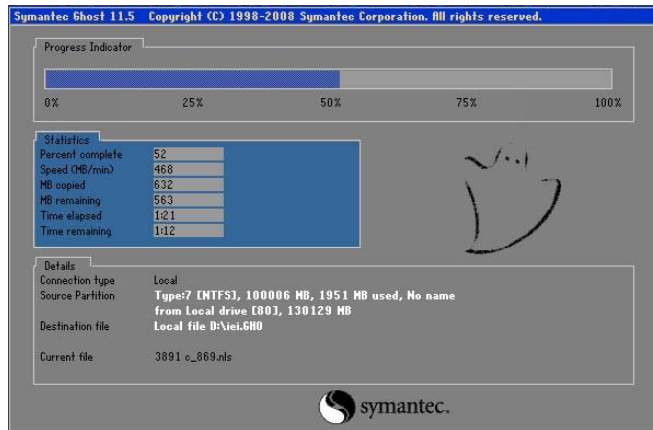

Figure B-27: Image Creation Complete

Step 8: After completing the system configuration, press any key in the following window to restart the system.

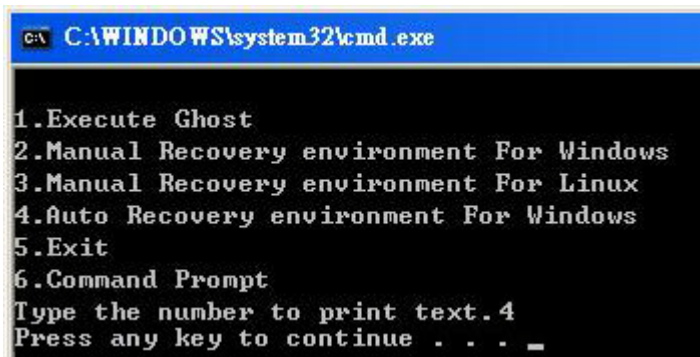

Figure B-28: Press any key to continue

Step 9: Eject the One Key Recovery CD and restart the system.

Step 10: Press the <DELETE> key as soon as the system is turned on to enter the BIOS.

Step 11: Enable the Auto Recovery Function option (**Advanced** → **iEi Feature** → **Auto Recovery Function**).

UPC-V315-QM77 Panel PC

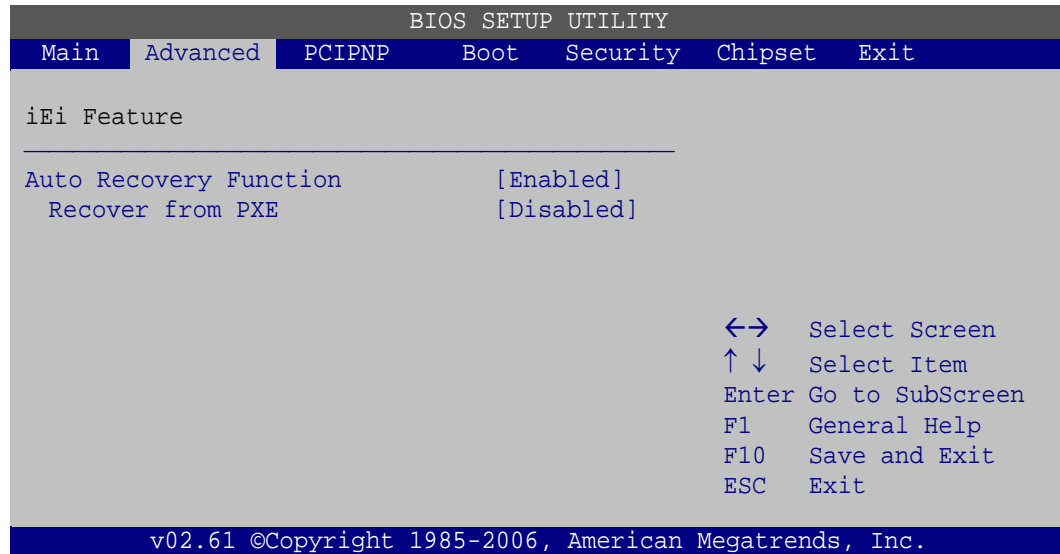
**BIOS Menu 25: IEI Feature**

Step 12: Save changes and restart the system. If the system encounters a Blue Screen of Death (BSoD) or a hang for around 10 minutes, it will automatically restore from the factory default image.

**CAUTION:**

The auto recovery function can only apply on a Microsoft Windows system running the following OS versions:

- Windows XP
- Windows Vista
- Windows 7

B.4 Setup Procedure for Linux

The initial setup procedure for Linux system is mostly the same with the procedure for Microsoft Windows. Please follow the steps below to setup recovery tool for Linux OS.

Step 1: **Hardware and BIOS setup.** Refer to **Section B.2.1.**

Step 2: Install Linux operating system. Make sure to install GRUB (v0.97 or earlier) MBR type and Ext3 partition type. Leave enough space on the hard drive to create the recover partition later.

**NOTE:**

If the Linux OS is not installed with GRUB (v0.97 or earlier) and Ext3, the Symantec Ghost may not function properly.

While installing Linux OS, please create two partitions:

- Partition 1: /
- Partition 2: **SWAP**

**NOTE:**

Please reserve enough space for partition 3 for saving recovery images.

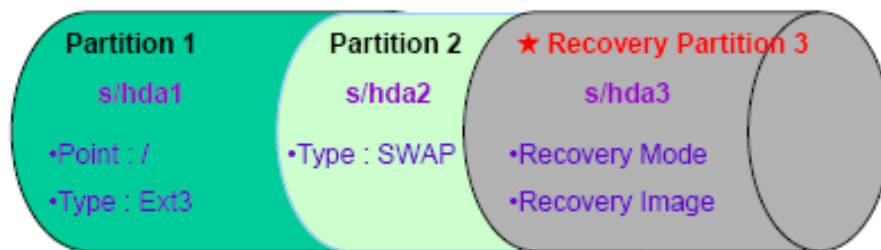

Figure B-29: Partitions for Linux

Step 3: Create a recovery partition. Insert the recovery CD into the optical disk drive. Follow **Step 1 ~ Step 3** described in **Section B.2.2**. Then type the following commands (marked in red) to create a partition for recovery images.

```
system32>diskpart
```

```
DISKPART>list vol
```

```
DISKPART>sel disk 0
```

```
DISKPART>create part pri size= ____  
DISKPART>assign letter=N  
DISKPART>exit  
system32>format N: /fs:ntfs /q /v:Recovery /y  
system32>exit
```

Step 4: **Build the recovery partition.** Press any key to boot from the recovery CD. It will take a while to launch the recovery tool. Please be patient. When the recovery tool setup menu appears, type <3> and press <Enter> (**Figure B-30**). The Symantec Ghost window appears and starts configuring the system to build a recovery partition. After completing the system configuration, press any key to reboot the system. Eject the recovery CD.

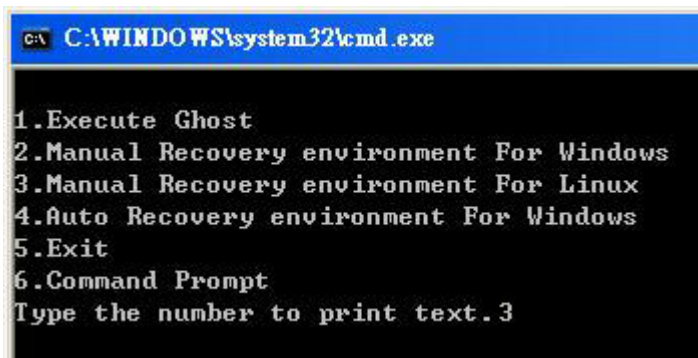
A screenshot of a Windows command prompt window. The title bar reads "C:\WINDOWS\system32\cmd.exe". The command prompt displays a menu with the following options:
1. Execute Ghost
2. Manual Recovery environment For Windows
3. Manual Recovery environment For Linux
4. Auto Recovery environment For Windows
5. Exit
6. Command Prompt
Below the menu, it says "Type the number to print text.3".

```
C:\WINDOWS\system32\cmd.exe  
1. Execute Ghost  
2. Manual Recovery environment For Windows  
3. Manual Recovery environment For Linux  
4. Auto Recovery environment For Windows  
5. Exit  
6. Command Prompt  
Type the number to print text.3
```

Figure B-30: Manual Recovery Environment for Linux

Step 5: **Access the recovery tool main menu by modifying the “menu.lst”.** To first access the recovery tool main menu, the menu.lst must be modified. In Linux, enter Administrator (root). When prompt appears, type:

```
cd /boot/grub  
vi menu.lst
```

```
Fedora release 9 (Sulphur)
Kernel 2.6.25-14.fc9.i686 on an i686 (tty2)

localhost login: root
Password:
[root@localhost ~]# cd /boot/grub/
[root@localhost grub]# vi menu.lst _
```

Figure B-31: Access menu.lst in Linux (Text Mode)

Step 6: Modify the menu.lst as shown below.

```
#boot=/dev/sda
default=0
timeout=10 ← Modify timeout=10
splashimage=(hd0,0)/grub/splash.xpm.gz
hiddenmenu
title Fedora (2.6.25-14.fc9.i686)
    root (hd0,0)
    kernel /vmlinuz-2.6.25-14.fc9.i686 ro root=UUID=10f1acda
    ac38b5c78910 rhgb quiet
    initrd /initrd-2.6.25-14.fc9.i686.img

title Recovery Partition
root (hd0,2)
makeactive ← Type command
chainloader +1
```

- Type command:
title Recovery Partition
root (hd0,2)
makeactive
chainloader +1

Step 7: The recovery tool menu appears. (Figure B-32)

```
1. Factory Restore
2. Backup system
3. Restore your last backup.
4. Manual
5. Quit
Please type the number to select and then press Enter:
```

Figure B-32: Recovery Tool Menu

Step 8: Create a factory default image. Follow Step 2 ~ Step 12 described in Section B.2.5 to create a factory default image.

B.5 Recovery Tool Functions

After completing the initial setup procedures as described above, users can access the recovery tool by pressing <F3> while booting up the system. However, if the setup procedure in Section B.3 has been completed and the auto recovery function is enabled, the system will automatically restore from the factory default image without pressing the F3 key. The recovery tool main menu is shown below.

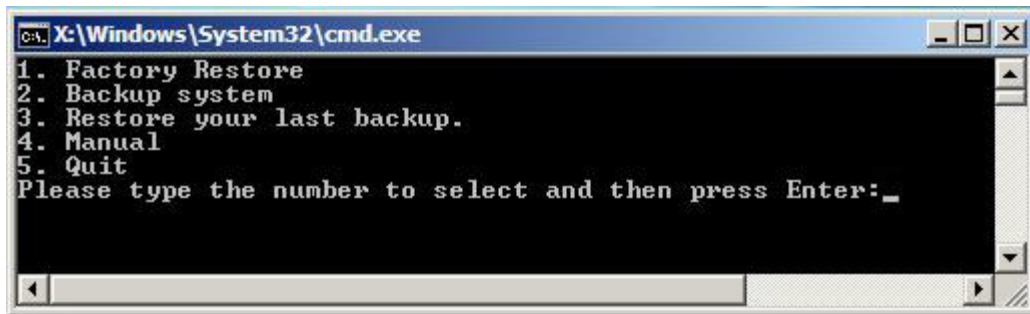

Figure B-33: Recovery Tool Main Menu

The recovery tool has several functions including:

1. **Factory Restore:** Restore the factory default image (iei.GHO) created in Section B.2.5.
2. **Backup system:** Create a system backup image (iei_user.GHO) which will be saved in the hidden partition.
3. **Restore your last backup:** Restore the last system backup image
4. **Manual:** Enter the Symantec Ghost window to configure manually.
5. **Quit:** Exit the recovery tool and restart the system.



WARNING:

Please do not turn off the system power during the process of system recovery or backup.



WARNING:

All data in the system will be deleted during the system recovery. Please backup the system files before restoring the system (either Factory Restore or Restore Backup).

B.5.1 Factory Restore

To restore the factory default image, please follow the steps below.

Step 1: Type <1> and press <Enter> in the main menu.

Step 2: The Symantec Ghost window appears and starts to restore the factory default. A factory default image called **iei.GHO** is created in the hidden Recovery partition.

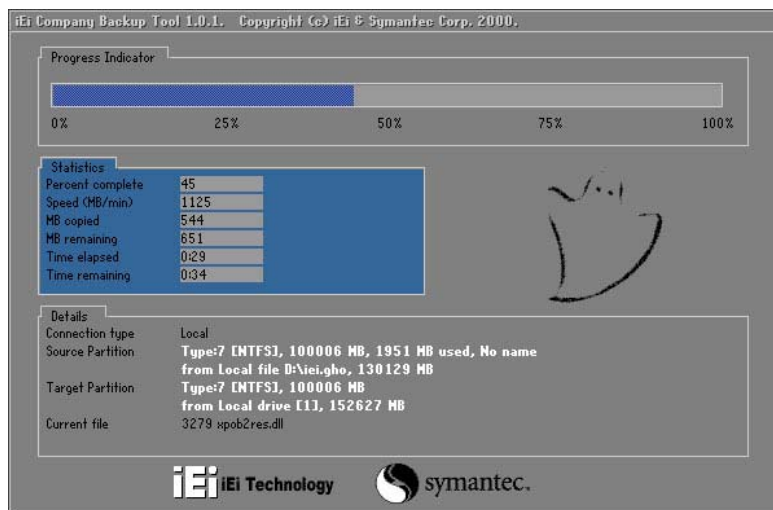
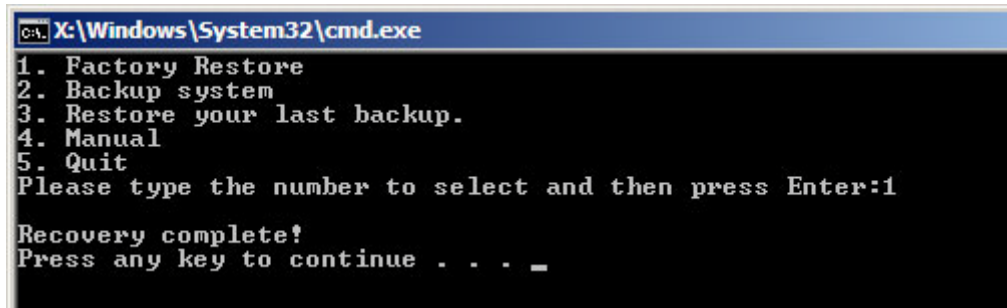

Figure B-34: Restore Factory Default

Step 3: The screen shown in **Figure B-35** appears when completed. Press any key to reboot the system.

UPC-V315-QM77 Panel PC



```

C:\X:\Windows\System32\cmd.exe
1. Factory Restore
2. Backup system
3. Restore your last backup.
4. Manual
5. Quit
Please type the number to select and then press Enter:1
Recovery complete!
Press any key to continue . . . _

```

Figure B-35: Recovery Complete Window

B.5.2 Backup System

To backup the system, please follow the steps below.

Step 1: Type <2> and press <Enter> in the main menu.

Step 2: The Symantec Ghost window appears and starts to backup the system. A backup image called **iei_user.GHO** is created in the hidden Recovery partition.

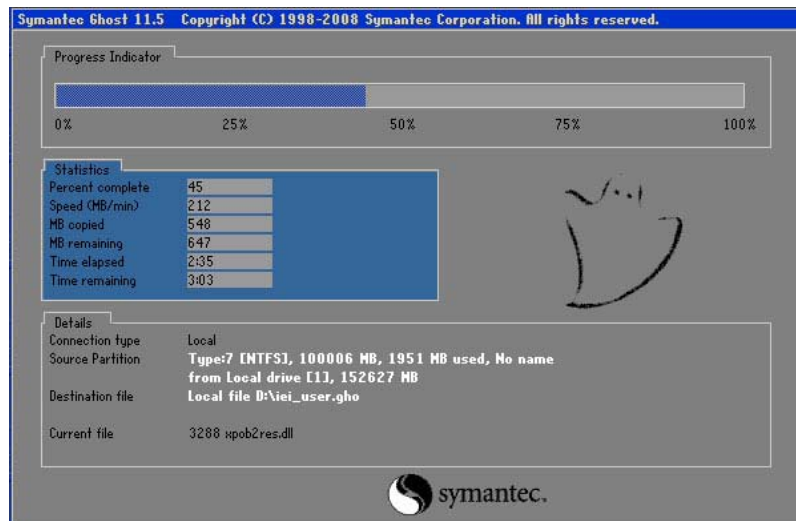

Figure B-36: Backup System

Step 3: The screen shown in **Figure B-37** appears when system backup is complete. Press any key to reboot the system.

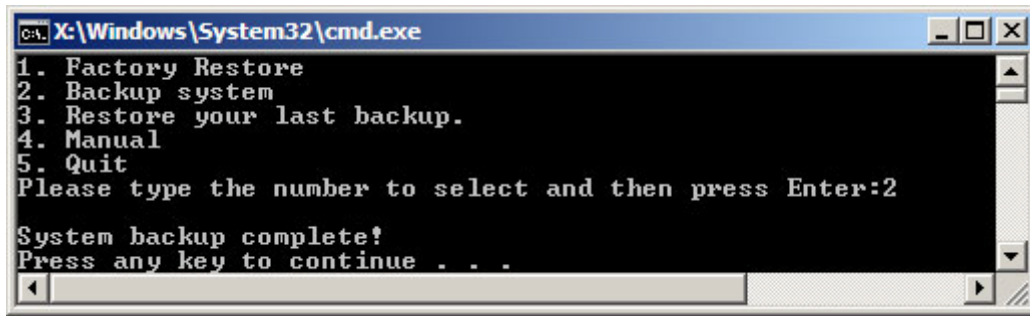

Figure B-37: System Backup Complete Window

B.5.3 Restore Your Last Backup

To restore the last system backup, please follow the steps below.

Step 1: Type <3> and press <Enter> in the main menu.

Step 2: The Symantec Ghost window appears and starts to restore the last backup image (iei_user.GHO).

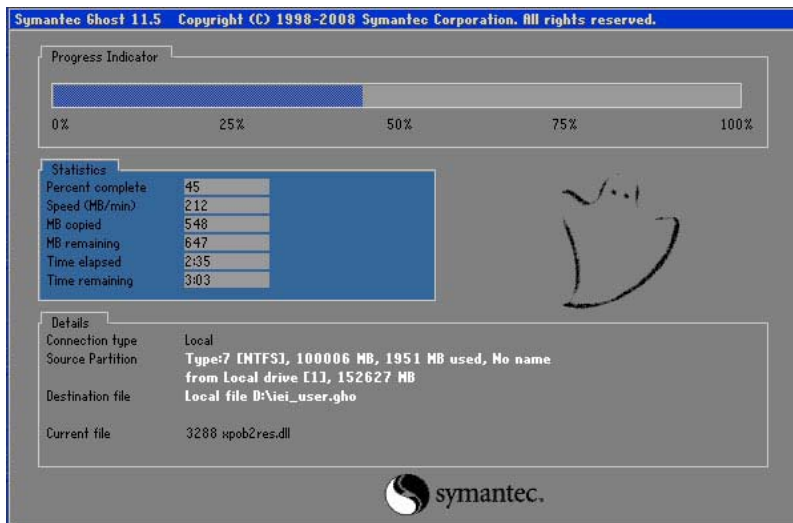
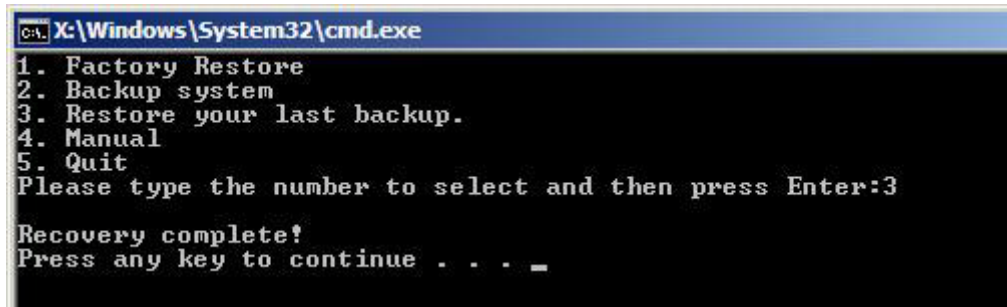

Figure B-38: Restore Backup

Step 3: The screen shown in **Figure B-39** appears when backup recovery is complete. Press any key to reboot the system.

UPC-V315-QM77 Panel PC



```
C:\X:\Windows\System32\cmd.exe
1. Factory Restore
2. Backup system
3. Restore your last backup.
4. Manual
5. Quit
Please type the number to select and then press Enter:3
Recovery complete!
Press any key to continue . . . _
```

Figure B-39: Restore System Backup Complete Window

B.5.4 Manual

To restore the last system backup, please follow the steps below.

Step 1: Type <4> and press <Enter> in the main menu.

Step 2: The Symantec Ghost window appears. Use the Ghost program to backup or recover the system manually.

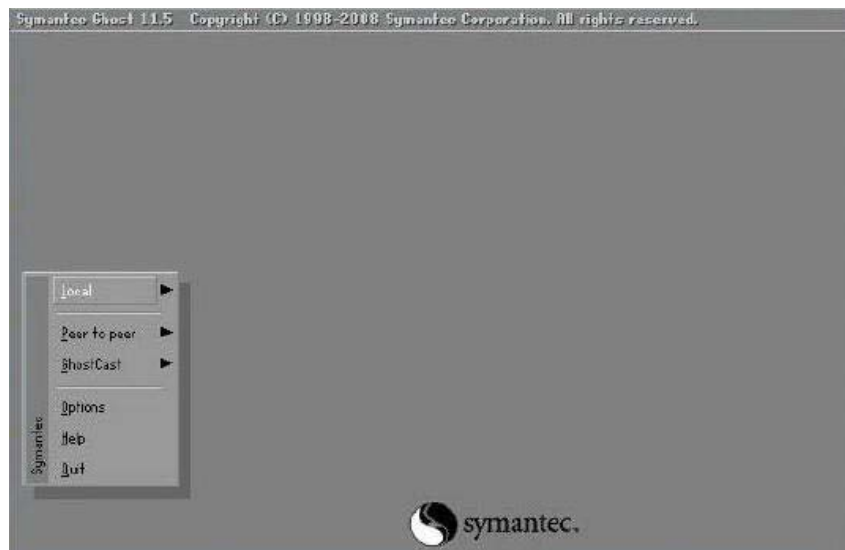
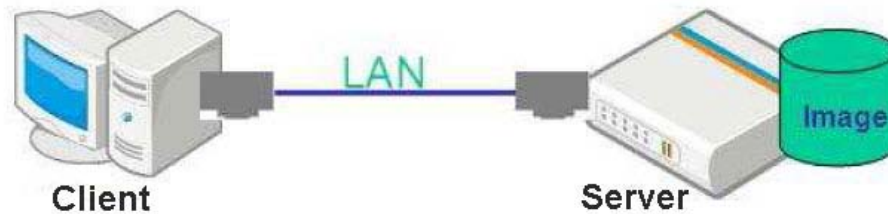

Figure B-40: Symantec Ghost Window

Step 3: When backup or recovery is completed, press any key to reboot the system.

B.6 Restore Systems from a Linux Server through LAN

The One Key Recovery allows a client system to automatically restore to a factory default image saved in a Linux system (the server) through LAN connectivity after encountering a Blue Screen of Death (BSoD) or a hang for around 10 minutes. To be able to use this function, the client system and the Linux system MUST reside in the same domain.



NOTE:

The supported client OS includes:

- Windows 2000
- Windows XP
- Windows Vista
- Windows 7
- Windows CE
- Windows XP Embedded

Prior to restoring client systems from a Linux server, a few setup procedures are required.

Step 1: Configure DHCP server settings

Step 2: Configure TFTP settings

Step 3: Configure One Key Recovery server settings

Step 4: Start DHCP, TFTP and HTTP

Step 5: Create a shared directory

Step 6: Setup a client system for auto recovery

The detailed descriptions are described in the following sections. In this document, two types of Linux OS are used as examples to explain the configuration process – CentOS 5.5 (Kernel 2.6.18) and Debian 5.0.7 (Kernel 2.6.26).

UPC-V315-QM77 Panel PC

B.6.1 Configure DHCP Server Settings

Step 1: Install the DHCP

`#yum install dhcp` (CentOS, commands marked in red)

`#apt-get install dhcp3-server` (Debian, commands marked in blue)

Step 2: Confirm the operating system default settings: dhcpd.conf.

CentOS

Use the following command to show the DHCP server sample location:

`#vi /etc/dhcpd.conf`

The DHCP server sample location is shown as below:

```
# DHCP Server Configuration file.
# see /usr/share/doc/dhcp*/dhcpd.conf.sample
#
```

Use the following command to copy the DHCP server sample to etc/dhcpd.conf:

`#cp /usr/share/doc/dhcp-3.0.5/dhcpd.conf.sample /etc/dhcpd.conf`

`#vi /etc/dhcpd.conf`

```
ddns-update-style interim;
ignore client-updates;

subnet 192.168.0.0 netmask 255.255.255.0 {
# --- default gateway
    option routers                192.168.0.2;
    option subnet-mask            255.255.255.0;

    option nis-domain             "domain.org";
    option domain-name            "domain.org";
    option domain-name-servers   192.168.0.1;
    next-server 192.168.0.6;
    filename "pxelinux.0";
    option time-offset            -18000; # Eastern Standard Time
    option ntp-servers            192.168.1.1;
    #
```

Debian

`#vi /etc/dhcpd.conf`

Edit “/etc/dhcpd.conf” for your environment. For example, add

`next-server PXE server IP address;`

filename "pxelinux.0";

```
ddns-update-style interim;
ignore client-updates;

subnet 192.168.0.0 netmask 255.255.255.0 {
# --- default gateway
    option routers                192.168.0.2;
    option subnet-mask            255.255.255.0;

    option nis-domain              "domain.org";
    option domain-name             "domain.org";
    option domain-name-servers    192.168.0.1;
    next-server 192.168.0.6;
    filename "pxelinux.0";
    option time-offset             -18000; # Eastern Standard Time
    option ntp-servers             192.168.1.1;
}
```

B.6.2 Configure TFTP Settings

Step 1: Install the tftp, httpd and syslinux.

```
#yum install tftp-server httpd syslinux (CentOS)
```

```
#apt-get install tftpd-hpa xinetd syslinux (Debian)
```

Step 2: Enable the TFTP server by editing the "/etc/xinetd.d/tftp" file and make it use the remap file. The "-vvv" is optional but it could definitely help on getting more information while running the remap file. For example:

CentOS

```
#vi /etc/xinetd.d/tftp
```

Modify:

```
disable = no
```

```
server_args = -s /tftpboot -m /tftpboot/tftpd.remap -vvv_
```

```
socket_type      = dgram
protocol        = udp
wait            = yes
user            = root
server          = /usr/sbin/in.tftpd
server_args     = -s /tftpboot -m /tftpboot/tftpd.remap -vvv
disable         = no
per_source      = 11
cps             = 100 2
flags           = IPv4
```

UPC-V315-QM77 Panel PC

Debian

Replace the TFTP settings from “inetd” to “xinetd” and annotate the “inetd” by adding “#”.

`#vi /etc/inetd.conf`

Modify: `#tftp dgram udp wait root /usr/sbin.....` (as shown below)

```
#:BOOT: TFTP service is provided primarily for booting. Most sites
#      run this only on machines acting as "boot servers."
#tftp  dgram  udp   wait  root  /usr/sbin/in.tftpd /usr/sbin/in.tftpd -s
#      /var/lib/tftpboot
```

`#vi /etc/xinetd.d/tftp`

```
socket_type      = dgram
protocol        = udp
wait            = yes
user           = root
server         = /usr/sbin/in.tftpd
server_args    = -s /tftpboot -m /tftpboot/tftpd.remap -vvv
disable        = no
per_source     = 11
cps            = 100 2
flags         = IPv4
```

B.6.3 Configure One Key Recovery Server Settings

Step 1: Copy the **Utility/RECOVERYR10.TAR.BZ2** package from the One Key Recovery CD to the system (server side).



Step 2: Extract the recovery package to /.

```
#cp RecoveryR10.tar.bz2 /
#cd /
#tar -xvjf RecoveryR10.tar.bz2
```

Step 3: Copy “pxelinux.0” from “syslinux” and install to “tftpboot”.

```
#cp /usr/lib/syslinux/pxelinux.0 /tftpboot/
```

B.6.4 Start the DHCP, TFTP and HTTP

Start the DHCP, TFTP and HTTP. For example:

CentOS

```
#service xinetd restart
```

```
#service httpd restart
```

```
#service dhcpd restart
```

Debian

```
#/etc/init.d/xinetd reload
```

```
#/etc/init.d/xinetd restart
```

```
#/etc/init.d/dhcp3-server restart
```

B.6.5 Create Shared Directory

Step 1: Install the samba.

```
#yum install samba
```

Step 2: Create a shared directory for the factory default image.

```
#mkdir /share
```

```
#cd /share
```

```
#mkdir /image
```

```
#cp iei.gho /image
```



WARNING:

The file name of the factory default image must be **iei.gho**.

Step 3: Confirm the operating system default settings: smb.conf.

```
#vi /etc/samba/smb.conf
```

UPC-V315-QM77 Panel PC

Modify:

[image]

comment = One Key Recovery

path = /share/image

browseable = yes

writable = yes

public = yes

create mask = 0644

directory mask = 0755

Step 4: Edit "/etc/samba/smb.conf" for your environment. For example:

```
# "security = user" is always a good idea. This will require a Unix account
# in this server for every user accessing the server. See
# /usr/share/doc/samba-doc/htmldocs/Samba3-HOWTO/ServerType.html
# in the samba-doc package for details.
security = share
```

```
[image]
comment = One Key Recovery
path = /share/image
browseable = yes
writable = yes
public = yes
create mask = 0644
directory mask = 0755
```

Step 5: Modify the hostname

```
#vi /etc/hostname
```

Modify: RecoveryServer

```
RecoveryServer
```

B.6.6 Setup a Client System for Auto Recovery

Step 1: Configure the following BIOS options of the client system.

Advanced → iEi Feature → Auto Recovery Function → **Enabled**

Advanced → iEi Feature → Recover from PXE → **Enabled**

Boot → Launch PXE OpROM → **Enabled**

Step 2: Continue to configure the **Boot Option Priorities** BIOS option of the client system:

Boot Option #1 → remain the default setting to boot from the original OS.

Boot Option #2 → select the boot from LAN option.

Step 3: Save changes and exit BIOS menu.

Exit → **Save Changes and Exit**

Step 4: Install the auto recovery utility into the system by double clicking the **Utility/AUTORECOVERY-SETUP.exe** in the One Key Recovery CD. This utility **MUST** be installed in the system, otherwise, the system will automatically restore from the factory default image every ten (10) minutes.



Step 5: Restart the client system from LAN. If the system encounters a Blue Screen of Death (BSoD) or a hang for around 10 minutes, it will automatically restore from the factory default image. The following screens will show when the system starts auto recovering.

```
Realtek PCIe GBE Family Controller Series v2.35 (06/14/10)
CLIENT MAC ADDR: 00 18 7D 13 E6 89  GUID: 00020003-0004-0005-0006-0007000000
DHCP . ./
```

```

My IP address seems to be C0A80009 192.168.0.9
ip=192.168.0.9:192.168.0.8:192.168.0.2:255.255.255.0
TFTP prefix:
Trying to load: pxelinux.cfg/00020003-0004-0005-0006-000700080009
Trying to load: pxelinux.cfg/01-00-10-7d-13-e6-89
Trying to load: pxelinux.cfg/C0A80009
Trying to load: pxelinux.cfg/C0A8000
Trying to load: pxelinux.cfg/C0A800
Trying to load: pxelinux.cfg/C0A80
Trying to load: pxelinux.cfg/C0A8
Trying to load: pxelinux.cfg/C0A
Trying to load: pxelinux.cfg/C0
Trying to load: pxelinux.cfg/C
Trying to load: pxelinux.cfg/default
boot:
    
```

```

Windows is loading files...

IP: 192.168.0.8, File: \Boot\WinPE.wim
    
```

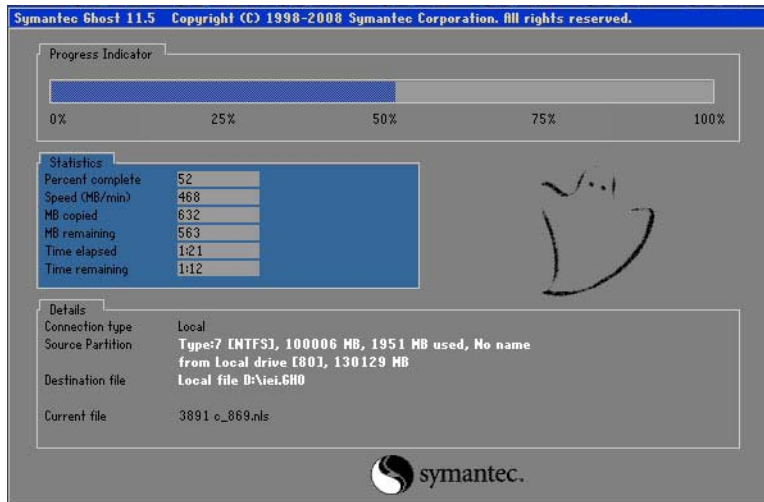

Symantec Ghost 11.5 Copyright (C) 1998-2008 Symantec Corporation. All rights reserved.

Progress Indicator: 50%

| Statistics | |
|------------------|------|
| Percent complete | 52 |
| Speed (MB/min) | 468 |
| MB copied | 632 |
| MB remaining | 563 |
| Time elapsed | 1:21 |
| Time remaining | 1:12 |

Handwritten mark: 201

| Details | |
|------------------|--|
| Connection type | Local |
| Source Partition | Type:7 [NTFS], 100006 MB, 1951 MB used, No name from Local drive [80], 130129 MB |
| Destination file | Local file D:\iei.GHO |
| Current file | 3891 e_869.nls |

Symantec logo



NOTE:

A firewall or a SELinux is not in use in the whole setup process. If there is a firewall or a SELinux protecting the system, modify the configuration information to accommodate them.

B.7 Other Information

B.7.1 Using AHCI Mode or ALi M5283 / VIA VT6421A Controller

When the system uses AHCI mode or some specific SATA controllers such as ALi M5283 or VIA VT6421A, the SATA RAID/AHCI driver must be installed before using one key recovery. Please follow the steps below to install the SATA RAID/AHCI driver.

Step 1: Copy the SATA RAID/AHCI driver to a floppy disk and insert the floppy disk into a USB floppy disk drive. The SATA RAID/AHCI driver must be especially designed for the on-board SATA controller.

Step 2: Connect the USB floppy disk drive to the system.

Step 3: Insert the One Key Recovery CD into the system and boot the system from the CD.

Step 4: When launching the recovery tool, press <F6>.

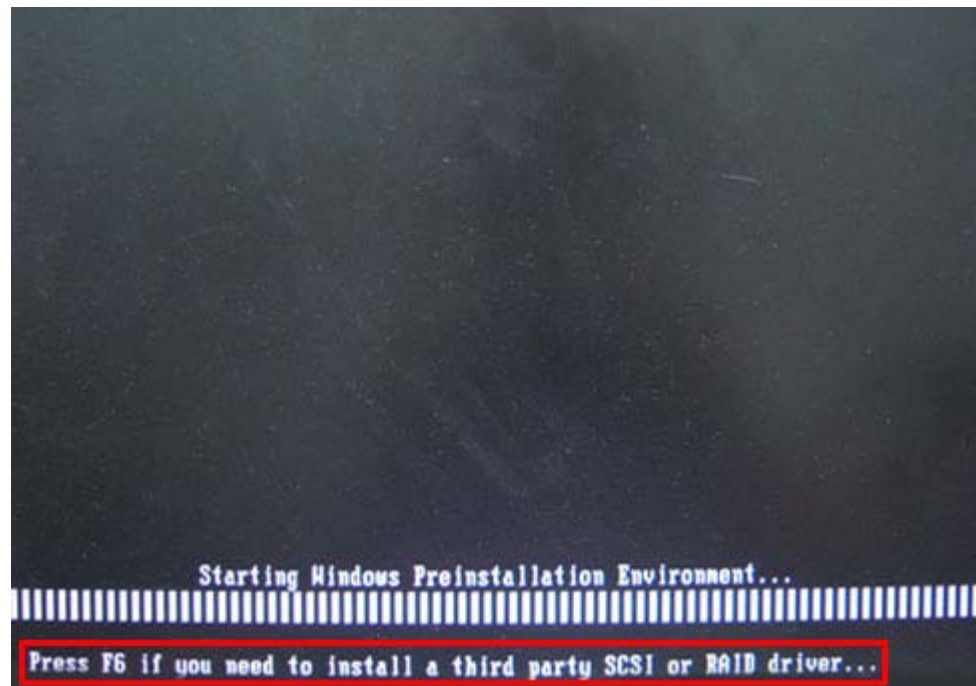

UPC-V315-QM77 Panel PC

Step 5: When the following window appears, press <S> to select “Specify Additional Device”.

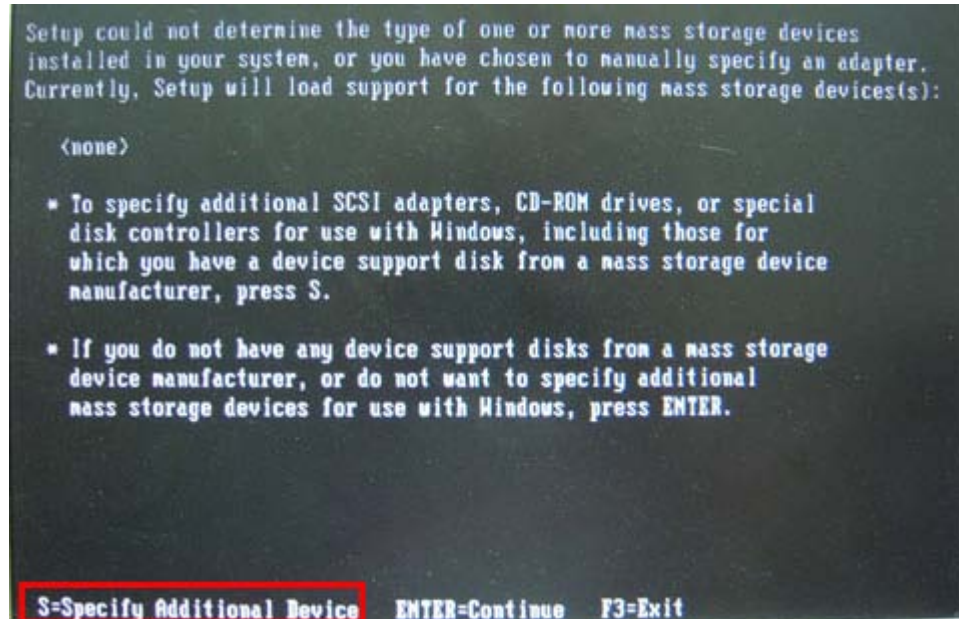

Step 6: In the following window, select a SATA controller mode used in the system. Then press <Enter>. The user can now start using the SATA HDD.

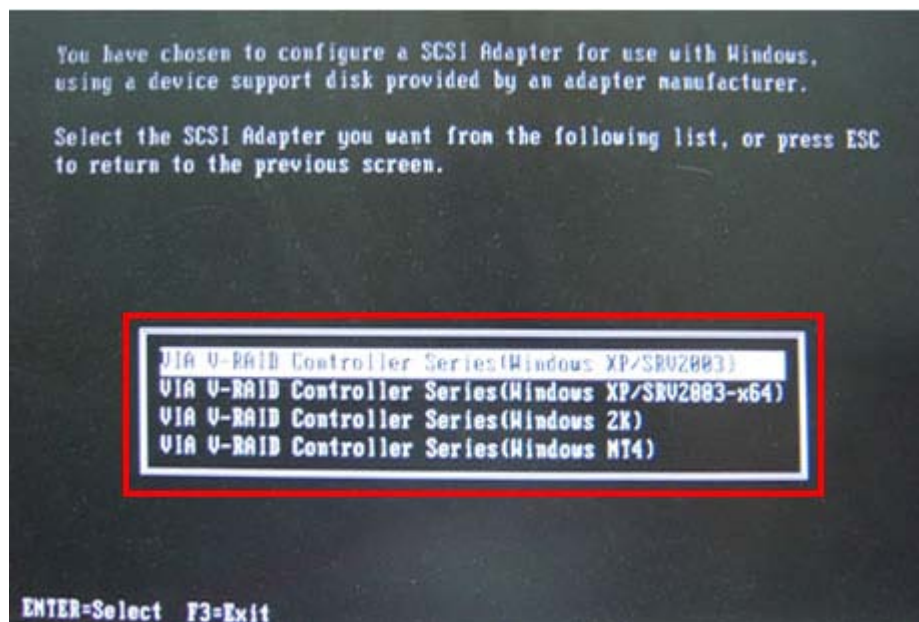

Step 7: After pressing <Enter>, the system will get into the recovery tool setup menu. Continue to follow the setup procedure from **Step 4** in **Section B.2.2 Create Partitions** to finish the whole setup process.

B.7.2 System Memory Requirement

To be able to access the recovery tool by pressing <F3> while booting up the system, please make sure to have enough system memory. The minimum memory requirement is listed below.

- Using Award BIOS: 128 MB system memory
- Using AMI BIOS: 512 MB system memory.

Appendix

C

Safety Precautions

**WARNING:**

The precautions outlined in this chapter should be strictly followed. Failure to follow these precautions may result in permanent damage to the UPC series.

C.1 Safety Precautions

Please follow the safety precautions outlined in the sections that follow:

C.1.1 General Safety Precautions

Please ensure the following safety precautions are adhered to at all times.

- **Follow the electrostatic precautions** outlined below whenever the UPC series is opened.
- **Make sure the power is turned off and the power cord is disconnected** whenever the UPC series is being installed, moved or modified.
- **Do not apply voltage levels that exceed the specified voltage range.** Doing so may cause fire and/or an electrical shock.
- **Electric shocks can occur** if the UPC series chassis is opened when the UPC series is running.
- **Do not drop or insert any objects** into the ventilation openings of the UPC series.
- **If considerable amounts of dust, water, or fluids enter the UPC series,** turn off the power supply immediately, unplug the power cord, and contact the UPC series vendor.
- **DO NOT:**
 - Drop the UPC series against a hard surface.
 - Strike or exert excessive force onto the LCD panel.
 - Touch any of the LCD panels with a sharp object
 - In a site where the ambient temperature exceeds the rated temperature

C.1.2 Anti-static Precautions



WARNING:

Failure to take ESD precautions during the installation of the UPC series may result in permanent damage to the UPC series and severe injury to the user.

Electrostatic discharge (ESD) can cause serious damage to electronic components, including the UPC series. Dry climates are especially susceptible to ESD. It is therefore critical that whenever the UPC series is opened and any of the electrical components are handled, the following anti-static precautions are strictly adhered to.

- **Wear an anti-static wristband:** Wearing a simple anti-static wristband can help to prevent ESD from damaging any electrical component.
- **Self-grounding:** Before handling any electrical component, touch any grounded conducting material. During the time the electrical component is handled, frequently touch any conducting materials that are connected to the ground.
- **Use an anti-static pad:** When configuring or working with an electrical component, place it on an anti-static pad. This reduces the possibility of ESD damage.
- **Only handle the edges of the electrical component:** When handling the electrical component, hold the electrical component by its edges.

C.1.3 Product Disposal



CAUTION:

Risk of explosion if battery is replaced by an incorrect type. Only certified engineers should replace the on-board battery.

Dispose of used batteries according to instructions and local regulations.

- Outside the European Union - If you wish to dispose of used electrical and electronic products outside the European Union, please contact your local authority so as to comply with the correct disposal method.
- Within the European Union:

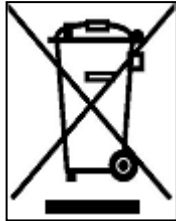

EU-wide legislation, as implemented in each Member State, requires that waste electrical and electronic products carrying the mark (left) must be disposed of separately from normal household waste. This includes monitors and electrical accessories, such as signal cables or power cords. When you need to dispose of your display products, please follow the guidance of your local authority, or ask the shop where you purchased the product. The mark on electrical and electronic products only applies to the current European Union Member States.

Please follow the national guidelines for electrical and electronic product disposal.

C.2 Maintenance and Cleaning Precautions

When maintaining or cleaning the UPC series, please follow the guidelines below.

C.2.1 Maintenance and Cleaning

Prior to cleaning any part or component of the UPC series, please read the details below.

- Except for the LCD panel, never spray or squirt liquids directly onto any other components. To clean the LCD panel, gently wipe it with a piece of soft dry cloth or a slightly moistened cloth.
- The interior of the UPC series does not require cleaning. Keep fluids away from the UPC series interior.
- Be cautious of all small removable components when vacuuming the UPC series.
- Turn the UPC series off before cleaning the UPC series.
- Never drop any objects or liquids through the openings of the UPC series.
- Be cautious of any possible allergic reactions to solvents or chemicals used when cleaning the UPC series.
- Avoid eating, drinking and smoking within vicinity of the UPC series.

C.2.2 Cleaning Tools

Some components in the UPC series may only be cleaned using a product specifically designed for the purpose. In such case, the product will be explicitly mentioned in the cleaning tips. Below is a list of items to use when cleaning the UPC series.

- **Cloth** – Although paper towels or tissues can be used, a soft, clean piece of cloth is recommended when cleaning the UPC series.
- **Water or rubbing alcohol** – A cloth moistened with water or rubbing alcohol can be used to clean the UPC series.
- **Using solvents** – The use of solvents is not recommended when cleaning the UPC series as they may damage the plastic parts.
- **Vacuum cleaner** – Using a vacuum specifically designed for computers is one of the best methods of cleaning the UPC series. Dust and dirt can restrict the airflow in the UPC series and cause its circuitry to corrode.
- **Cotton swabs** - Cotton swaps moistened with rubbing alcohol or water are excellent tools for wiping hard to reach areas.
- **Foam swabs** - Whenever possible, it is best to use lint free swabs such as foam swabs for cleaning.

Appendix

E

Hazardous Materials Disclosure

D.1 Hazardous Material Disclosure Table for IPB Products Certified as RoHS Compliant Under 2002/95/EC Without Mercury

The details provided in this appendix are to ensure that the product is compliant with the Peoples Republic of China (China) RoHS standards. The table below acknowledges the presences of small quantities of certain materials in the product, and is applicable to China RoHS only.

A label will be placed on each product to indicate the estimated “Environmentally Friendly Use Period” (EFUP). This is an estimate of the number of years that these substances would “not leak out or undergo abrupt change.” This product may contain replaceable sub-assemblies/components which have a shorter EFUP such as batteries and lamps. These components will be separately marked.

Please refer to the table on the next page.

| Part Name | Toxic or Hazardous Substances and Elements | | | | | |
|-------------------------|--|--------------|--------------|------------------------------|--------------------------------|---------------------------------------|
| | Lead (Pb) | Mercury (Hg) | Cadmium (Cd) | Hexavalent Chromium (CR(VI)) | Polybrominated Biphenyls (PBB) | Polybrominated Diphenyl Ethers (PBDE) |
| Housing | O | O | O | O | O | O |
| Display | O | O | O | O | O | O |
| Printed Circuit Board | O | O | O | O | O | O |
| Metal Fasteners | O | O | O | O | O | O |
| Cable Assembly | O | O | O | O | O | O |
| Fan Assembly | O | O | O | O | O | O |
| Power Supply Assemblies | O | O | O | O | O | O |
| Battery | O | O | O | O | O | O |

O: This toxic or hazardous substance is contained in all of the homogeneous materials for the part is below the limit requirement in SJ/T11363-2006

X: This toxic or hazardous substance is contained in at least one of the homogeneous materials for this part is above the limit requirement in SJ/T11363-2006

UPC-V315-QM77 Panel PC

此附件旨在确保本产品符合中国 RoHS 标准。以下表格标示此产品中某有毒物质的含量符合中国 RoHS 标准规定的限量要求。

本产品上会附有“环境友好使用期限”的标签，此期限是估算这些物质“不会有泄漏或突变”的年限。本产品可能包含有较短的环境友好使用期限的可替换元件，像是电池或灯管，这些元件将会单独标示出来。

| 部件名称 | 有毒有害物质或元素 | | | | | |
|--------|-----------|-----------|-----------|-----------------|---------------|-----------------|
| | 铅 (Pb) | 汞 (Hg) | 镉 (Cd) | 六价铬 (CR(VI)) | 多溴联苯 (PBB) | 多溴二苯醚 (PBDE) |
| 壳体 | ○ | ○ | ○ | ○ | ○ | ○ |
| 显示 | ○ | ○ | ○ | ○ | ○ | ○ |
| 印刷电路板 | ○ | ○ | ○ | ○ | ○ | ○ |
| 金属螺帽 | ○ | ○ | ○ | ○ | ○ | ○ |
| 电缆组装 | ○ | ○ | ○ | ○ | ○ | ○ |
| 风扇组装 | ○ | ○ | ○ | ○ | ○ | ○ |
| 电力供应组装 | ○ | ○ | ○ | ○ | ○ | ○ |
| 电池 | ○ | ○ | ○ | ○ | ○ | ○ |

○: 表示该有毒有害物质在该部件所有物质材料中的含量均在 SJ/T11363-2006 标准规定的限量要求以下。
 X: 表示该有毒有害物质至少在该部件的某一均质材料中的含量超出 SJ/T11363-2006 标准规定的限量要求。