



MODEL:  
**TANK-760**

High Performance Fanless Embedded System with Intel® Core i5-4400E/  
Celeron 2000E processor, VGA, HDMI, DisplayPort,  
9-36V DC input and RoHS Compliant

# User Manual

# Revision

---

Date	Version	Changes
25 December, 2014	1.02	Add Chapter 4: System Motherboard
5 December, 2014	1.01	Update Section 3.7.4: CAN-bus Terminal Blocks Pinouts
22 August, 2014	1.00	Initial release

# Copyright

---

## COPYRIGHT NOTICE

The information in this document is subject to change without prior notice in order to improve reliability, design and function and does not represent a commitment on the part of the manufacturer.

In no event will the manufacturer be liable for direct, indirect, special, incidental, or consequential damages arising out of the use or inability to use the product or documentation, even if advised of the possibility of such damages.

This document contains proprietary information protected by copyright. All rights are reserved. No part of this manual may be reproduced by any mechanical, electronic, or other means in any form without prior written permission of the manufacturer.

## TRADEMARKS

All registered trademarks and product names mentioned herein are used for identification purposes only and may be trademarks and/or registered trademarks of their respective owners.

# Table of Contents

<b>1 INTRODUCTION.....</b>	<b>12</b>
1.1 OVERVIEW.....	13
1.2 MODEL VARIATIONS .....	13
1.3 FEATURES.....	13
1.4 TECHNICAL SPECIFICATIONS .....	14
1.5 CONNECTOR PANEL.....	16
1.5.1 Front Panel .....	16
1.5.2 Rear Panel .....	17
1.6 LED INDICATORS .....	19
1.7 DIMENSIONS.....	21
<b>2 UNPACKING .....</b>	<b>22</b>
2.1 ANTI-STATIC PRECAUTIONS .....	23
2.2 UNPACKING PRECAUTIONS.....	23
2.3 UNPACKING CHECKLIST .....	24
<b>3 INSTALLATION .....</b>	<b>26</b>
3.1 INSTALLATION PRECAUTIONS .....	27
3.2 HARD DISK DRIVE (HDD) INSTALLATION.....	27
3.3 SO-DIMM INSTALLATION .....	30
3.4 PLUGGABLE DC-IN TERMINAL BLOCK INSTALLATION .....	31
3.5 FOOT PAD INSTALLATION .....	32
3.6 MOUNTING THE SYSTEM WITH MOUNTING BRACKETS .....	33
3.7 EXTERNAL PERIPHERAL INTERFACE CONNECTORS.....	34
3.7.1 ACC Mode Switch.....	35
3.7.2 AT/ATX Power Mode Switch.....	35
3.7.3 Audio Connector .....	36
3.7.4 CAN-bus Terminal Blocks .....	36
3.7.5 Digital I/O Connector .....	37
3.7.6 HDMI Connector .....	37
3.7.7 LAN Connectors.....	38

## TANK-760 Embedded System

3.7.8 Power Input, 4-pin Terminal Block.....	40
3.7.1 Power Input, 4-pin DIN Connector .....	40
3.7.2 RS-232 Serial Port Connectors.....	41
3.7.3 RS-232/422/485 Serial Port Connectors .....	43
3.7.4 USB Connectors.....	44
3.7.5 VGA Connector.....	45
3.8 POWERING ON/OFF THE SYSTEM .....	47
3.9 POWER .....	48
3.9.1 ACC ON Mode.....	48
3.9.2 ACC OFF Mode.....	49
<b>4 SYSTEM MOTHERBOARD .....</b>	<b>50</b>
4.1 OVERVIEW.....	1
4.1.1 Layout .....	1
4.2 INTERNAL PERIPHERAL CONNECTORS .....	2
4.2.1 Clear CMOS Switch (J_CMOS1).....	3
4.2.2 Power Button (PWRBTN1) .....	3
4.2.3 Reset button (RESET1) .....	3
4.2.4 Battery Connector (BAT1).....	4
4.2.5 BIOS Flash Connector (SPI2) .....	4
4.2.6 CFast Card connector (CFAST1).....	4
4.2.7 DIO Connector (DIO1).....	5
4.2.8 EC Debug Connector (LPT_DB1).....	5
4.2.9 EC Flash Connector (JSPI1).....	5
4.2.10 LED Connector (LED_CN).....	6
4.2.11 Power Connector (MPWR_IN1) .....	6
4.2.12 SATA 6Gb/s Drive Connectors (SATA1, SATA2).....	6
4.2.13 SATA Power Connectors (SATA_PWR1, SATA_PWR2).....	7
4.2.14 SMBUS Connector (SMB1).....	7
4.3 EXTERNAL INTERFACE PANEL CONNECTORS .....	7
4.3.1 Audio Jack (JAUDIO1).....	8
4.3.2 CANBUS connector (CAN1).....	8
4.3.3 DisplayPort connector (DISPLAY_PORT1).....	8
4.3.4 Ethernet and USB3.0 Connectors (LAN1_USB1).....	9
4.3.5 Ethernet and USB3.0 Connectors (LAN2_USB2).....	9

4.3.6 HDMI Connector (HDMI1).....	10
4.3.7 Power Connector (SPWR_IN1).....	10
4.3.8 RS-232 Serial Port Connector (COM1&2, COM3&4).....	11
4.3.9 RS-232/422/485 Serial Port Connector (COM5&6).....	11
4.3.10 USB 2.0 Connectors (USB56).....	11
4.3.11 VGA Connector (VGA1).....	12
<b>5 BIOS.....</b>	<b>13</b>
5.1 INTRODUCTION.....	14
5.1.1 Starting Setup.....	14
5.1.2 Using Setup.....	14
5.1.3 Getting Help.....	15
5.1.4 Unable to Reboot after Configuration Changes.....	15
5.1.5 BIOS Menu Bar.....	15
5.2 MAIN.....	17
5.3 ADVANCED.....	18
5.3.1 ACPI Settings.....	19
5.3.2 RTC Wake Settings.....	20
5.3.3 CPU Configuration.....	22
5.3.4 SATA Configuration.....	24
5.3.5 Intel(R) Rapid Start Technology.....	25
5.3.6 USB Configuration.....	26
5.3.7 F81866 Super IO Configuration.....	27
5.3.7.1 Serial Port n Configuration.....	28
5.3.8 F81866 H/W Monitor.....	33
5.3.9 Serial Port Console Redirection.....	33
5.3.10 iEi Feature.....	37
5.4 CHIPSET.....	38
5.4.1 PCH-IO Configuration.....	39
5.4.1.1 PCH Azalia Configuration.....	40
5.4.2 System Agent (SA) Configuration.....	41
5.4.2.1 Graphics Configuration.....	41
5.4.2.2 Memory Configuration.....	44
5.5 BOOT.....	45
5.6 SECURITY.....	47

TANK-760 Embedded System

5.7 SAVE & EXIT .....	48
<b>A SAFETY PRECAUTIONS .....</b>	<b>49</b>
A.1 SAFETY PRECAUTIONS .....	50
<i>A.1.1 General Safety Precautions</i> .....	50
<i>A.1.2 Anti-static Precautions</i> .....	50
<i>A.1.3 Product Disposal</i> .....	51
A.2 MAINTENANCE AND CLEANING PRECAUTIONS .....	52
<i>A.2.1 Maintenance and Cleaning</i> .....	52
<i>A.2.2 Cleaning Tools</i> .....	52
<b>B HAZARDOUS MATERIALS DISCLOSURE .....</b>	<b>54</b>
B.1 HAZARDOUS MATERIALS DISCLOSURE TABLE FOR IPB PRODUCTS CERTIFIED AS ROHS COMPLIANT UNDER 2002/95/EC WITHOUT MERCURY .....	55

# List of Figures

---

Figure 1-1: TANK-760 .....	13
Figure 1-2: TANK-760 Front Panel .....	17
Figure 1-3: TANK-760 Rear Panel .....	18
Figure 1-4: TANK-760 LED Indicators.....	19
Figure 1-5: Physical Dimensions (mm) .....	21
Figure 3-1: Bottom Panel Retention Screws.....	28
Figure 3-2: HDD Bracket Retention Screws.....	28
Figure 3-3: HDD Installation .....	29
Figure 3-4: HDD Retention Screws .....	29
Figure 3-5: SO-DIMM Socket .....	30
Figure 3-6: SO-DIMM Installation .....	31
Figure 3-7: Pluggable DC-in Terminal Block Installation .....	32
Figure 3-8: Foot Pad Installation.....	33
Figure 3-9: Mounting Bracket Retention Screws .....	33
Figure 3-10: ACC Mode Switch .....	35
Figure 3-11: AT/ATX Power Mode Switch .....	35
Figure 3-12: Audio Connector .....	36
Figure 3-13: CAN-bus Terminal Blocks Pinouts.....	36
Figure 3-14: Digital I/O Connector Pinout Location .....	37
Figure 3-15: LAN Connection .....	39
Figure 3-16: RJ-45 Ethernet Connector.....	39
Figure 3-17: 4-pin Terminal Block Pinout Location .....	40
Figure 3-18: Power Input Connector.....	41
Figure 3-19: Serial Device Connector.....	42
Figure 3-20: Serial Port Pinout Location .....	42
Figure 3-21: Serial Device Connector.....	43
Figure 3-22: Serial Port Pinout Location .....	44
Figure 3-23: USB Device Connection .....	45
Figure 3-24: VGA Connector .....	46
Figure 3-25: VGA Connector .....	46



## TANK-760 Embedded System

<b>Figure 3-26: Power Button</b> .....	<b>47</b>
<b>Figure 3-27: Power Connectors</b> .....	<b>48</b>
<b>Figure 4-1: System Motherboard (Front)</b> .....	<b>1</b>
<b>Figure 4-2: System Motherboard (Rear)</b> .....	<b>2</b>

# List of Tables

---

<b>Table 1-1: Technical Specifications</b> .....	<b>16</b>
<b>Table 1-2: LED Indicators Description</b> .....	<b>19</b>
<b>Table 3-1: CAN-bus Terminal Blocks Pinouts</b> .....	<b>36</b>
<b>Table 3-2: Digital I/O Connector Pinouts</b> .....	<b>37</b>
<b>Table 3-3: HDMI Connector Pinouts</b> .....	<b>38</b>
<b>Table 3-4: LAN Pinouts</b> .....	<b>39</b>
<b>Table 3-5: RJ-45 Ethernet Connector LEDs</b> .....	<b>40</b>
<b>Table 3-6: 4-pin Terminal Block Pinouts</b> .....	<b>40</b>
<b>Table 3-7: Power Input Pinouts</b> .....	<b>41</b>
<b>Table 3-8: Serial Port Pinouts</b> .....	<b>42</b>
<b>Table 3-9: DB-9 Connector Pinouts</b> .....	<b>44</b>
<b>Table 3-10: USB Port Pinouts</b> .....	<b>45</b>
<b>Table 3-11: VGA Connector Pinouts</b> .....	<b>47</b>
<b>Table 3-12: Power LED Indicators Description</b> .....	<b>48</b>
<b>Table 4-1: Peripheral Interface Connectors</b> .....	<b>3</b>
<b>Table 4-2: Clear CMOS Switch Pinouts (J_CMOS1)</b> .....	<b>3</b>
<b>Table 4-3: Power Button Pinouts (PWRBTN1)</b> .....	<b>3</b>
<b>Table 4-4: Reset Button Pinouts (RESET1)</b> .....	<b>3</b>
<b>Table 4-5: Battery Connector Pinouts (BAT1)</b> .....	<b>4</b>
<b>Table 4-6: BIOS Flash Connector Pinouts (SPI2)</b> .....	<b>4</b>
<b>Table 4-7: CFast Card Connector Pinouts (CFAST1)</b> .....	<b>4</b>
<b>Table 4-8: DIO Connector Pinouts (DIO1)</b> .....	<b>5</b>
<b>Table 4-9: EC Debug Connector Pinouts (LPT_DB1)</b> .....	<b>5</b>
<b>Table 4-10: EC Flash Connector Pinouts (JSPI1)</b> .....	<b>5</b>
<b>Table 4-11: LED Connector Pinouts (J2)</b> .....	<b>6</b>
<b>Table 4-12: Power Connector Pinouts (MPWR_IN1)</b> .....	<b>6</b>
<b>Table 4-13: SATA 6Gb/s Drive Connectors Pinouts (SATA1, SATA2)</b> .....	<b>6</b>
<b>Table 4-14: SATA Power Connectors Pinouts (SATA_PWR1, SATA_PWR2)</b> .....	<b>7</b>
<b>Table 4-15: SMBUS Connector Pinouts (SMB1)</b> .....	<b>7</b>
<b>Table 4-16: Rear Panel Connectors</b> .....	<b>8</b>

## TANK-760 Embedded System

<b>Table 4-17: Audio Jack Pinouts (AUDIO1)</b> .....	<b>8</b>
<b>Table 4-18: CANBUS connector Pinouts (CAN1)</b> .....	<b>8</b>
<b>Table 4-19: DisplayPort connector Pinouts (DISPLAY_PORT1)</b> .....	<b>9</b>
<b>Table 4-20: USB 3.0 Port Pinouts (USB1)</b> .....	<b>9</b>
<b>Table 4-21: LAN Pinouts (LAN1)</b> .....	<b>9</b>
<b>Table 4-22: USB 3.0 Port Pinouts (USB2)</b> .....	<b>10</b>
<b>Table 4-23: LAN Pinouts (LAN2)</b> .....	<b>10</b>
<b>Table 4-24: HDMI Connector Pinouts (HDMI1)</b> .....	<b>10</b>
<b>Table 4-25: Power Connector Pinouts (PWR2)</b> .....	<b>11</b>
<b>Table 4-26: RS-232 Serial Port Connector Pinouts (COM1&amp;2, COM3&amp;4)</b> .....	<b>11</b>
<b>Table 4-27: RS-232/422/485 Serial Port Connector Pinouts (COM5&amp;6)</b> .....	<b>11</b>
<b>Table 4-28: USB 2.0 Connectors Pinouts (USB1)</b> .....	<b>11</b>
<b>Table 4-29: VGA Connector Pinouts (VGA1)</b> .....	<b>12</b>
<b>Table 5-1: BIOS Navigation Keys</b> .....	<b>15</b>

Chapter

1

# Introduction

---

## TANK-760 Embedded System

### 1.1 Overview



**Figure 1-1: TANK-760**

The TANK-760 is a platform based on the 4th generation Intel® Core™ i5 or Celeron® processor and the Intel® HM86 chipset.

The TANK-760 contains VGA, DisplayPort and HDMI video outputs, which can be applied to multi-display application and support high Full HD video quality. The TANK-760 is equipped with an abundant of I/O ports and supports a wide range of operating temperature. Four USB 3.0 and two USB 2.0 ports provide flexible expansion options. Serial device connectivity is provided by four RS-232 and two RS-232/422/485 ports.

The TANK-760 can be used as a control center for in-vehicle application, such as buses or trucks. With dual CAN-bus port, more peripheral devices can be connected for vehicle applications.

### 1.2 Model Variations

The model variations of the TANK-760 Series are listed below.

Model No.	Processor
TANK-760-HM86i-i5/4G-R10	Intel® Core™ i5 dual-core i5-4400E 2.7 GHz,
TANK-760-HM86i-C/4G-R10	Intel® Celeron® dual-core 2000E 2.2 GHz

### 1.3 Features

The TANK-760 features are listed below:

- Intel® Core™ i5-4400E 2.7 GHz dual-core processor

Intel® Celeron® 2000E 2.2 GHz dual-core processor

- One CFAST socket
- Support three independent video outputs
- Built-in two 2.5" SATA 6Gb/s HDD bays
- 9 V~36 V DC input
- Support IEI iRIS-2400 (IPMI 2.0 compliant)

## 1.4 Technical Specifications

The TANK-760 technical specifications are listed in **Table 1-1**.

Specifications	
Chassis	
Color	Black C + Silver
Dimensions (WxDxH)	310 x 200 x 69.8mm
System Fan	Fanless
Chassis Construction	Extruded aluminum alloy Heavy duty steel sheet
<b>Motherboard</b>	
CPU	Intel® Core i5-4400E/ Celeron 2000E
Chipset	Intel® HM86
Memory	2 x 204-pin DDR3 SDRAM SO-DIMM
<b>iRIS Module</b>	
iRIS Solution	iRIS-2400
<b>Storage</b>	
Hard Drive	2 x 2.5" SATA HDD Bay
CFAST	1 x CFAST
SD card	N/A
<b>I/O Interfaces</b>	
USB	4 x USB 3.0 ports 2 x USB 2.0 ports

## TANK-760 Embedded System

Specifications	
Ethernet	2 x RJ-45 1 x PCIe GbE by Intel® I210 1 x PCIe GbE by Intel® I217LM
RS-232	4 x DB-9 with isolation
RS-232/422/485	2 x DB-9 RS-232/422/485 with isolation
Digital I/O	8-bit digital I/O, 4-bit input/4-bit output
CAN-bus	2 x Phoenix terminal block with isolation
Display	1 x VGA, 1 x HDMI, 1 x DisplayPort
Resolution	VGA: Up to 1920 x 1200@60Hz HDMI: Up to 2500 x 1600@60Hz DisplayPort: Up to 2500 x 1600@60Hz
Audio	1 x Line-out, 1 x Mic-in
Other	Optional 4-channel audio/video input PCIe Mini Card
Wireless	1 x 802.11 a/b/g/n ( optional)
Expansions	
PCIe Mini	3 x Full Size (one support mSATA)
Power	
Power Input	Terminal Block: 9 (+/- 0.3v) V~36 V DC DC Jack: 9 (+/- 0.3v) V~36 V DC
Power Consumption	19 V@3.2 A (Intel® Core™ i5 i5-4400E with 4 GB memory)
Reliability	
Mounting	Wall mount
Operating Temperature	-20°C ~ 70°C with air flow (SSD)
Storage Temperature	-30°C ~ 80°C
Humidity	5% ~ 95%, non-condensing
Operating Shock	Half-sine wave shock 5G, 11ms, 3 shocks per axis

Specifications	
Operating Vibration	MIL-STD-810F 514.5C-2 (with SSD)
Weight (Net/Gross)	3.8Kg/6.5Kg
Safety & EMC	CE/FCC E-mark
OS	
Supported OS	Microsoft® Windows 8E Microsoft® WES7E

**Table 1-1: Technical Specifications**

## 1.5 Connector Panel

### 1.5.1 Front Panel

The TANK-760 front panel contains:

- 2 x CAN-bus terminal blocks with isolation
- 1 x CFast
- 1 x DisplayPort
- 1 x OLED indicators
- 1 x Power button
- 2 x RS-232/422/485 serial ports with isolation
- 2 x USB 2.0 ports
- 2 x Wi-Fi antenna connectors

An overview of the front panel is shown in **Figure 1-2**.



## TANK-760 Embedded System

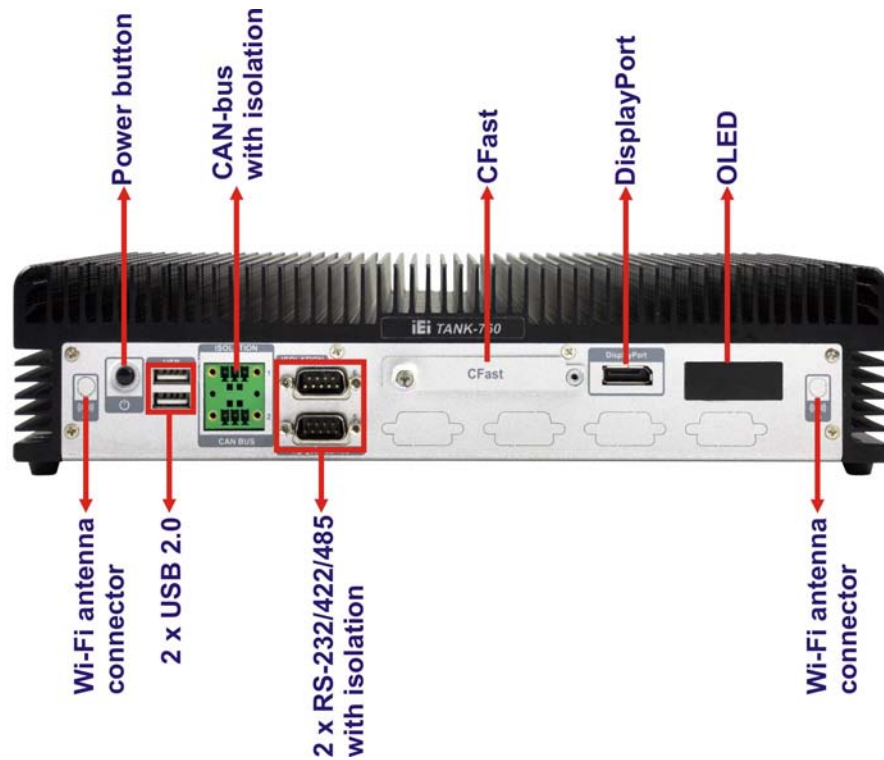

**Figure 1-2: TANK-760 Front Panel**

### 1.5.2 Rear Panel

The TANK-760 rear panel contains:

- 1 x ACC switch
- 1 x AT/ATX switch
- 1 x DIO port
- 1 x HDMI port
- 1 x Line-out port (green)
- 1 x Mic-in port (pink)
- 1 x 4-pin power jack for 9 (+/- 0.3v) V ~ 36V power input
- 1 x 4-pin terminal block for 9 (+/- 0.3v) V ~ 36V power input
- 1 x Reset button
- 2 x RJ-45 LAN ports
- 4 x RS-232 serial ports with isolation
- 4 x USB 3.0 ports
- 1 x VGA port

An overview of the rear panel is shown in **Figure 1-3** below.

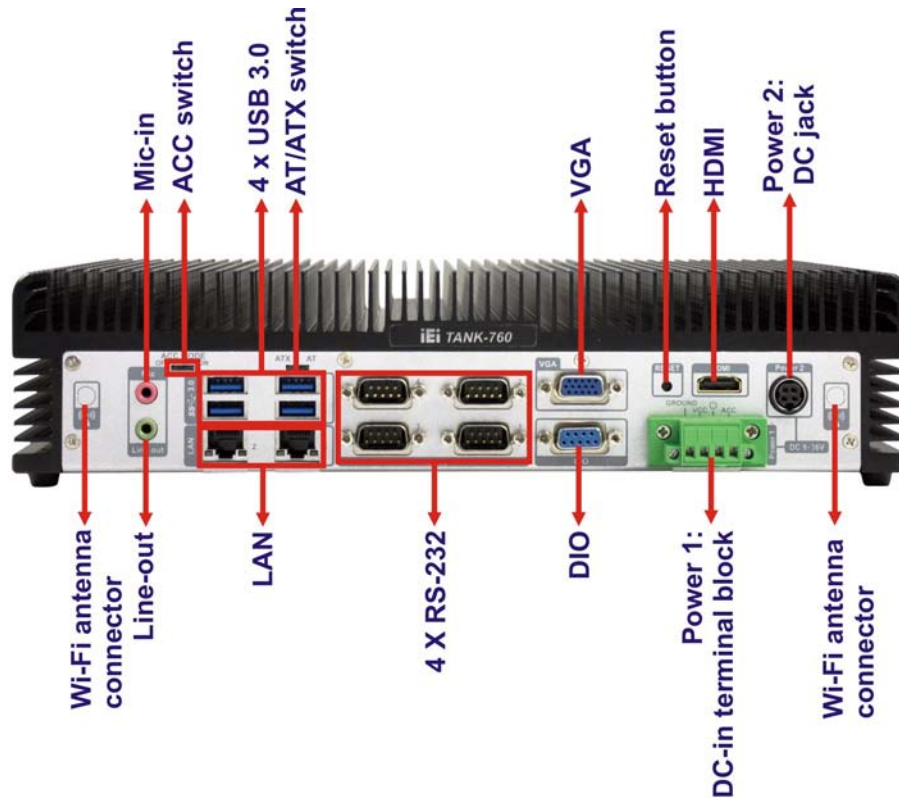
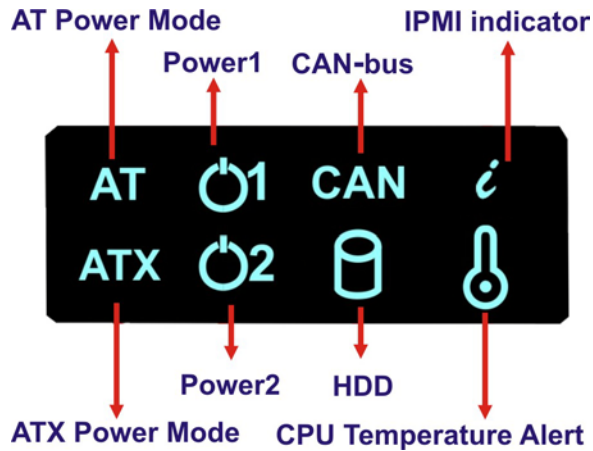

**Figure 1-3: TANK-760 Rear Panel**

TANK-760 Embedded System

1.6 LED Indicators

There are several indicators on the front panel of the TANK-760 as shown in **Figure 1-4**.



**Figure 1-4: TANK-760 LED Indicators**

The descriptions of each LED indicator are listed below.

LED Indicator	Description
AT Power Mode	The current power mode status is AT mode. Controlled by the AT/ATX power mode switch.
ATX Power Mode	The current power mode status is ATX mode. Controlled by the AT/ATX power mode switch.
Power LED1	<b>Breathing Orange:</b> Standby mode.
Power LED2	<b>Solid blue:</b> Power-on mode.
CAN-bus	Shows CAN-bus status.
HDD	Shows HDD status.
i	Shows IPMI status.
CPU Temperature Alert	BLUE: CPU temperature is normal. RED: CPU temperature is too high.

**Table 1-2: LED Indicators Description**



**WARNING:**

The CPU Temperature Alert LED turns red when the CPU temperature is too high. If this situation occurs, lower the environment temperature or close some running applications to cool down the CPU.

---

TANK-760 Embedded System

1.7 Dimensions

The physical dimensions are shown below:

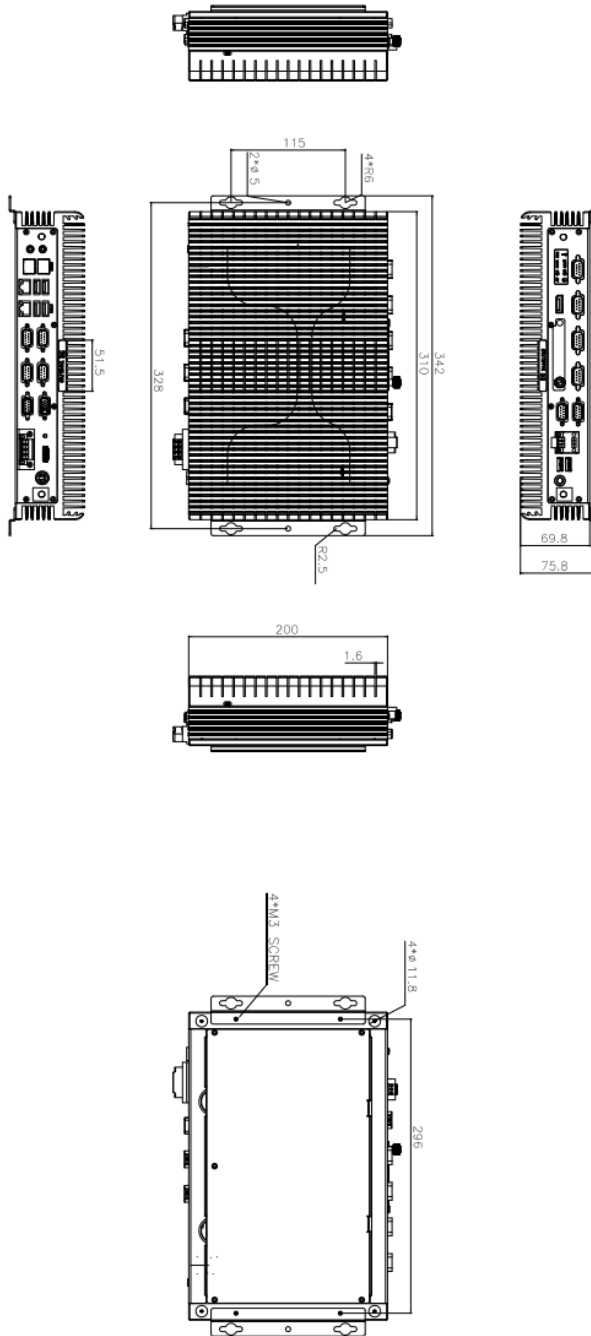

Figure 1-5: Physical Dimensions (mm)

Chapter

2

# Unpacking

---

## 2.1 Anti-static Precautions

---



### WARNING:

Failure to take ESD precautions during installation may result in permanent damage to the TANK-760 and severe injury to the user.

---

Electrostatic discharge (ESD) can cause serious damage to electronic components, including the TANK-760. Dry climates are especially susceptible to ESD. It is therefore critical that whenever the TANK-760 or any other electrical component is handled, the following anti-static precautions are strictly adhered to.

- **Wear an anti-static wristband:** Wearing a simple anti-static wristband can help to prevent ESD from damaging the board.
- **Self-grounding:** Touch any grounded conducting material before handling the board. During the time the board is handled, frequently touch any conducting materials that are connected to the ground.
- **Use an anti-static pad:** When configuring the TANK-760, place it on an anti-static pad. This reduces the possibility of ESD damaging the TANK-760.

## 2.2 Unpacking Precautions

When the TANK-760 is unpacked, please do the following:

- Follow the anti-static precautions outlined in **Section 2.1**.
- Make sure the packing box is facing upwards so the TANK-760 does not fall out of the box.
- Make sure all the components shown in **Section 2.3** are present.

### 2.3 Unpacking Checklist



**NOTE:**



If some of the components listed in the checklist below are missing, please do not proceed with the installation. Contact the IEI reseller or vendor you purchased the TANK-760 from or contact an IEI sales representative directly. To contact an IEI sales representative, please send an email to [sales@iei.com.tw](mailto:sales@iei.com.tw).

The TANK-760 is shipped with the following components:

Quantity	Item and Part Number	Image
Standard		
1	TANK-760 Series	
1	Power adapter (P/N: 63040-010090-050-RS)	
1	Power cord (P/N: 32702-000401-100-RS)	
2	Mounting brackets (P/N: 41020-0163J4-00-RS)	
8	Screw kits (P/N: 19600-000259-00-RS)	
1	Pluggable DC-in terminal block (P/N: 33001-000435-RS)	



## TANK-760 Embedded System

Quantity	Item and Part Number	Image
Standard		
1	Utility CD ( <b>P/N:</b> 7B000-001051-RS)	
1	One Key Recovery CD ( <b>P/N:</b> 7B000-000781-RS)	

Chapter

3

# Installation

---

### 3.1 Installation Precautions

During installation, be aware of the precautions below:

- **Read the user manual:** The user manual provides a complete description of the TANK-760, installation instructions and configuration options.
- **DANGER! Disconnect Power:** Power to the TANK-760 must be disconnected during the installation process, or before any attempt is made to access the rear panel. Electric shock and personal injury might occur if the rear panel of the TANK-760 is opened while the power cord is still connected to an electrical outlet.
- **Qualified Personnel:** The TANK-760 must be installed and operated only by trained and qualified personnel. Maintenance, upgrades, or repairs may only be carried out by qualified personnel who are familiar with the associated dangers.
- **Air Circulation:** Make sure there is sufficient air circulation when installing the TANK-760. The TANK-760's cooling vents must not be obstructed by any objects. Blocking the vents can cause overheating of the TANK-760. Leave at least 5 cm of clearance around the TANK-760 to prevent overheating.
- **Grounding:** The TANK-760 should be properly grounded. The voltage feeds must not be overloaded. Adjust the cabling and provide external overcharge protection per the electrical values indicated on the label attached to the back of the TANK-760.

### 3.2 Hard Disk Drive (HDD) Installation

To install the hard drive, please follow the steps below:

- Step 1:** Remove the bottom panel by removing the five retention screws from the bottom panel.

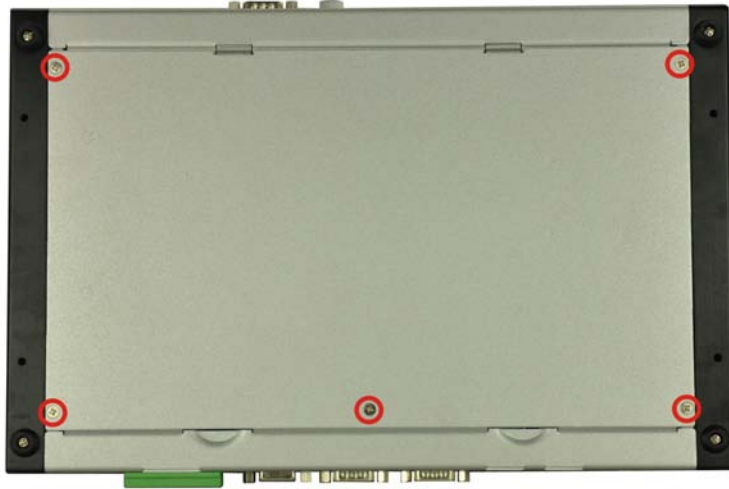

**Figure 3-1: Bottom Panel Retention Screws**

**Step 2:** Remove the four HDD bracket retention screws and unplug the SATA signal and power cables connected to the TANK-760. And then lift the HDD bracket out of the TANK-760 and put it on a flat surface.



**Figure 3-2: HDD Bracket Retention Screws**

## TANK-760 Embedded System

**Step 3:** Attach each HDD to the HDD bracket, and then slide each HDD to connect the SATA connectors.

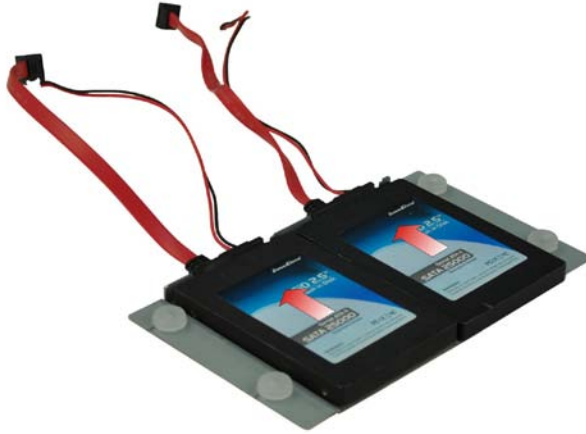

**Figure 3-3: HDD Installation**

**Step 4:** Secure each HDD with the HDD bracket by four retention screws (eight in all).

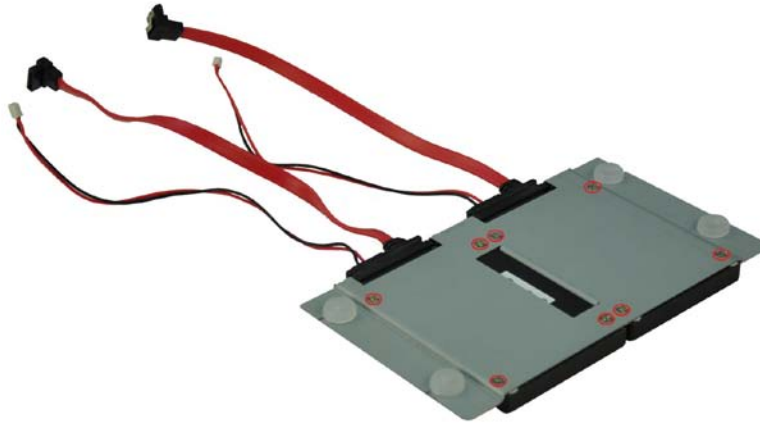

**Figure 3-4: HDD Retention Screws**

**Step 5:** Secure the HDD bracket with TANK-760 by the four retention screws that were previously removed.

**Step 6:** Reconnect the SATA signal and power cables to the TANK-760.

**Step 7:** Reinstall the bottom panel to the TANK-760.

### 3.3 SO-DIMM Installation

**WARNING:**

Using incorrectly specified SO-DIMM may cause permanent damage to the TANK-760. Please make sure the purchased SO-DIMM complies with the memory specifications of the TANK-760.

To install a SO-DIMM into a SO-DIMM socket, please follow the steps below.

- Step 1:** Remove the bottom panel by removing the five retention screws from the bottom panel (**Figure 3-1**).
- Step 2:** Unplug the SATA signal and power cables connected to the TANK-760, and then place the bottom panel on a flat surface.
- Step 3:** Locate the SO-DIMM socket on the motherboard (**Figure 3-5**).

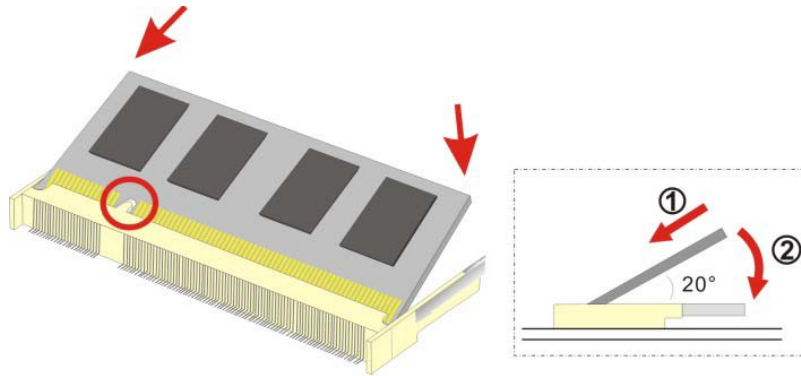

Figure 3-5: SO-DIMM Socket

## TANK-760 Embedded System

**Step 4:** Align the SO-DIMM with the socket. The SO-DIMM must be oriented in such a way that the notch in the middle of the SO-DIMM must be aligned with the plastic bridge in the socket (**Figure 3-6**).

**Step 5:** Push the SO-DIMM into the socket at an angle (**Figure 3-6**).



**Figure 3-6: SO-DIMM Installation**

**Step 6:** Gently pull the arms of the SO-DIMM socket out and push the rear of the SO-DIMM down (**Figure 3-6**).

**Step 7:** Release the arms on the SO-DIMM socket. They clip into place and secure the SO-DIMM in the socket.

**Step 8:** Install the bracket that was previously removed in the same position it was before.

**Step 9:** Reinstall the bottom panel to the TANK-760.

### 3.4 Pluggable DC-In Terminal Block Installation

To install the pluggable DC-in terminal block, please follow the steps below:

**Step 1:** Locate the DC-in terminal block connector. The location of the connector is shown in **Figure 1-3**.

**Step 2:** Align the pluggable DC-in terminal block with the DC-in terminal block connector on the TANK-760.

- Step 3:** Once aligned, insert the pluggable DC-in terminal block into the DC-in terminal block connector.
- Step 4:** Secure the pluggable DC-in terminal block to the external interface by tightening the two retention screws on either side of the terminal block (**Figure 3-7**).



**Figure 3-7: Pluggable DC-in Terminal Block Installation**

### 3.5 Foot Pad Installation

To install the foot pads, follow the instructions below.

- Step 1:** Turn the TANK-760 to the bottom panel.
- Step 2:** Locate the four retention screw holes for the foot pad in the bottom surface.
- Step 3:** Align the hole of the foot pad with the retention screw holes on the bottom surface.
- Step 4:** Secure the foot pad to the chassis by four retention screw.



## TANK-760 Embedded System



Figure 3-8: Foot Pad Installation

### 3.6 Mounting the System with Mounting Brackets

To mount the embedded system onto a wall or some other surface using the two mounting brackets, please follow the steps below.

**Step 1:** Turn the embedded system over.

**Step 2:** Align the two retention screw holes in each bracket with the corresponding retention screw holes on the sides of the bottom surface (**Figure 3-9**).



Figure 3-9: Mounting Bracket Retention Screws

- Step 3:** Secure the brackets to the system by tightening two retention screws into each bracket (**Figure 3-9**).
- Step 4:** Drill holes in the intended installation surface.
- Step 5:** Align the mounting holes in the sides of the mounting brackets with the predrilled holes in the mounting surface.
- Step 6:** Insert four retention screws, two in each bracket, to secure the system to the wall.

### 3.7 External Peripheral Interface Connectors

The TANK-760 has the following connectors. Detailed descriptions of the connectors can be found in the subsections below.

- ACC mode switch
- AT/ATX power mode switch
- Audio connector
- CAN-bus terminal blocks
- Digital I/O connector
- HDMI connector
- LAN connectors
- Power input terminal block
- Power input DC jack
- RS-232 serial port connectors
- RS-232/422/485 serial port connectors
- USB connectors
- VGA connectors

## TANK-760 Embedded System

### 3.7.1 ACC Mode Switch

The TANK-760 allows turning the ACC mode on or off. The setting can be made through the ACC mode switch on the rear panel as shown below.



Figure 3-10: ACC Mode Switch

### 3.7.2 AT/ATX Power Mode Switch

The TANK-760 supports AT and ATX power modes. The setting can be made through the AT/ATX power mode switch on the rear panel as shown below.

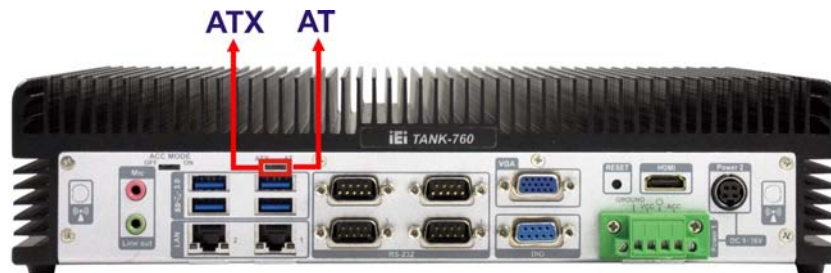

Figure 3-11: AT/ATX Power Mode Switch

### 3.7.3 Audio Connector

CN Label: Line out and Mic  
 CN Type: Audio jack  
 CN Location: See **Figure 3-12**

The audio jacks connect to external audio devices.

- **Microphone (Pink):** Connects a microphone.
- **Line Out port (Green):** Connects to a headphone or a speaker. With multi-channel configurations, this port can also connect to front speakers.



**Figure 3-12: Audio Connector**

### 3.7.4 CAN-bus Terminal Blocks

There are two 3-pin CAN-bus terminal blocks. The pinouts are shown in **Figure 3-13** and **Table 3-1**.

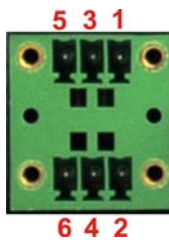

**Figure 3-13: CAN-bus Terminal Blocks Pinouts**

Pin	Description	Pin	Description
1	CAN1H	2	CAN2H
3	CAN1L	4	CAN2L
5	GND	6	GND

**Table 3-1: CAN-bus Terminal Blocks Pinouts**

## TANK-760 Embedded System

### 3.7.5 Digital I/O Connector

- CN Label: **DIO**
- CN Type: DB-9 male connector
- CN Location: See **Figure 1-3**
- CN Pinouts: See **Table 3-2** and **Figure 3-14**

The digital I/O connector provides programmable input and output for external devices. The pinouts for the digital I/O connector are listed in the table below.

Pin	Description	Pin	Description
1	DIN1	6	DOUT3
2	DOUT1	7	DIN4
3	DIN2	8	DOUT4
4	DOUT2	9	VCC
5	DIN3		

**Table 3-2: Digital I/O Connector Pinouts**

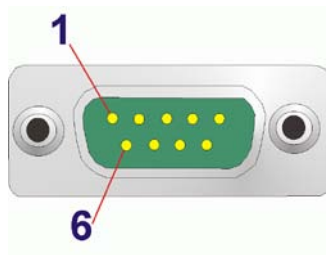

**Figure 3-14: Digital I/O Connector Pinout Location**

### 3.7.6 HDMI Connector

- CN Label: **HDMI**
- CN Type: HDMI type A connector
- CN Location: See **Figure 1-3**
- CN Pinouts: See **Table 3-3**

The HDMI (High-Definition Multimedia Interface) connector connects to digital audio or video sources.

Pin	Description	Pin	Description
1	HDMI_DATA2-1_L	2	GND
3	HDMI_DATA2#-1_L	4	HDMI_DATA1-1_L
5	GND	6	HDMI_DATA1#-1_L
7	HDMI_DATA0-1_L	8	GND
9	HDMI_DATA0#-1_L	10	HDMI_CLK-1_L
11	GND	12	HDMI_CLK#-1_L
13	NC	14	NC
15	HDMI_SCL-1	16	HDMI_SDA-1
17	GND	18	+V5S
19	HDMI_HPD-1		

**Table 3-3: HDMI Connector Pinouts**

### 3.7.7 LAN Connectors

- CN Label: **LAN1, LAN2**
- CN Type: RJ-45
- CN Location: See **Figure 1-3**
- CN Pinouts: See **Table 3-4**

The LAN connectors allow connection to an external network.

**Step 1: Locate the RJ-45 connectors.** The locations of the RJ-45 connectors are shown in **Figure 1-3**.

**Step 2: Align the connectors.** Align the RJ-45 connector on the LAN cable with one of the RJ-45 connectors on the TANK-760. See **Figure 3-15**.

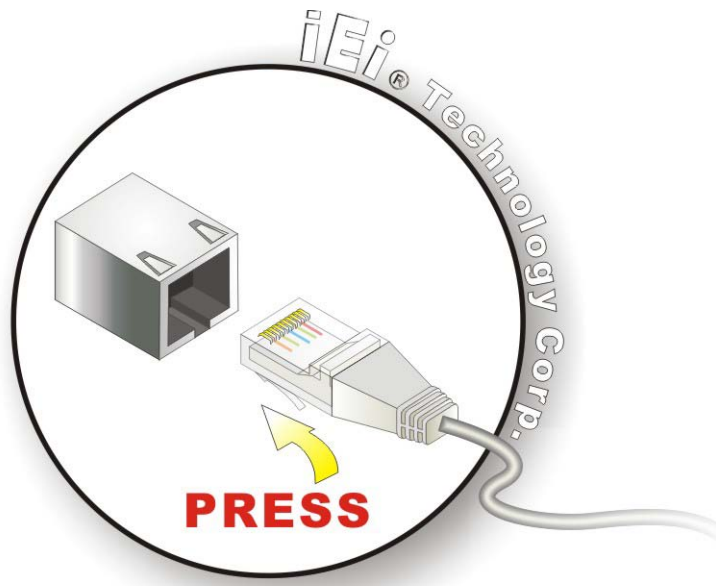

Figure 3-15: LAN Connection

**Step 3:** Insert the LAN cable RJ-45 connector. Once aligned, gently insert the LAN cable RJ-45 connector into the system RJ-45 connector.

Pin	Description	Pin	Description
1	MD10+	5	MD12+
2	MD10-	6	MD12-
3	MD11+	7	MD13+
4	MD11-	8	MD13-

Table 3-4: LAN Pinouts



Figure 3-16: RJ-45 Ethernet Connector

The RJ-45 Ethernet connector has two status LEDs, one green and one yellow. The green LED indicates activity on the port and the yellow LED indicates the port is linked. See Table 3-5.

Activity/Link LED		Speed LED	
STATUS	DESCRIPTION	STATUS	DESCRIPTION
Off	No link	Off	10 Mbps connection
Yellow	Linked	Green	100 Mbps connection
Blinking	TX/RX activity	Orange	1 Gbps connection

**Table 3-5: RJ-45 Ethernet Connector LEDs**

### 3.7.8 Power Input, 4-pin Terminal Block

CN Label: **POWER 1**

CN Type: 4-pin terminal block

CN Location: See **Figure 1-3**

CN Pinouts: See **Table 3-6**

Connect the leads of a 9V~36V DC power supply into the terminal block. Make sure that the power and ground wires are attached to the correct sockets of the connector.

Pin	Description	Pin	Description
1	GND	3	Power button
2	VCC	4	ACC

**Table 3-6: 4-pin Terminal Block Pinouts**

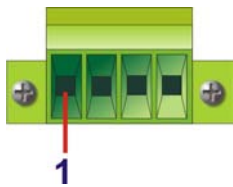

**Figure 3-17: 4-pin Terminal Block Pinout Location**

### 3.7.1 Power Input, 4-pin DIN Connector

CN Label: **POWER 2**

CN Type: 4-pin DIN connector

CN Location: See **Figure 1-3**

CN Pinouts: See **Table 3-7** and **Figure 3-18**



## TANK-760 Embedded System

The power connector connects to the 9V~36V DC power adapter.



**Figure 3-18: Power Input Connector**

Pin	Description	Pin	Description
1	+12V	3	+12V
2	GND	4	GND

**Table 3-7: Power Input Pinouts**

### 3.7.2 RS-232 Serial Port Connectors

CN Label: **COM1, COM2, COM3, COM4**

CN Type: DB-9 connectors

CN Location: See **Figure 1-3**

CN Pinouts: See **Table 3-8** and **Figure 3-20**

RS-232 serial port devices can be attached to the RS-232 serial ports on the rear panel.

**Step 1: Locate the DB-9 connector.** The locations of the DB-9 connectors are shown in **Figure 1-3**.

**Step 2: Insert the serial connector.** Insert the DB-9 connector of a serial device into the DB-9 connector on the external peripheral interface. See **Figure 3-19**.

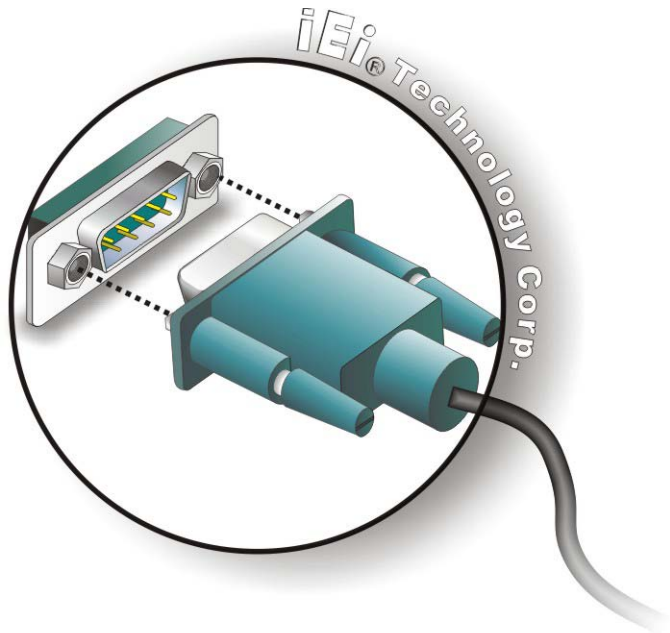
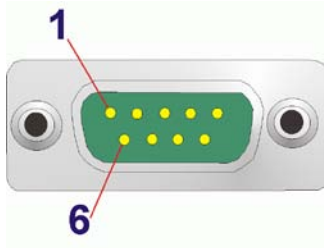

**Figure 3-19: Serial Device Connector**

**Step 3: Secure the connector.** Secure the serial device connector to the external interface by tightening the two retention screws on either side of the connector.

Pin	Description	Pin	Description
1	NDCD	2	NSIN
3	NSOUT	4	NDTR
5	GND	6	NDSR
7	NRTS	8	NCTS
9	XRI		

**Table 3-8: Serial Port Pinouts**



**Figure 3-20: Serial Port Pinout Location**

## TANK-760 Embedded System

## 3.7.3 RS-232/422/485 Serial Port Connectors

CN Label:	<b>COM5, COM6</b>
CN Type:	DB-9 connectors
CN Location:	See <b>Figure 1-3</b>
CN Pinouts:	See <b>Table 3-9</b> and <b>Figure 3-22</b>

RS-232/422/485 serial port devices can be attached to the RS-232/422/485 serial ports on the front panel.

**Step 1:** **Locate the DB-9 connector.** The locations of the DB-9 connectors are shown in **Figure 1-3**.

**Step 2:** **Insert the serial connector.** Insert the DB-9 connector of a serial device into the DB-9 connector on the external peripheral interface. See **Figure 3-21**.

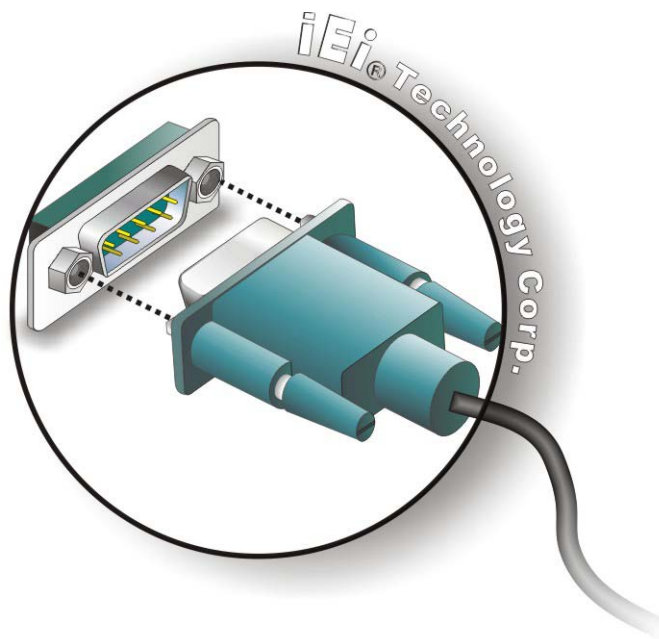
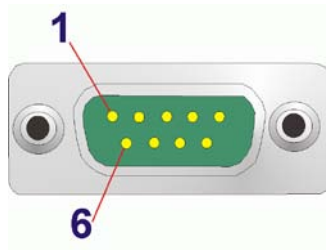

**Figure 3-21: Serial Device Connector**

**Step 3:** **Secure the connector.** Secure the serial device connector to the external interface by tightening the two retention screws on either side of the connector.

Pin	Description (RS-232)	Description (RS-422)	Description (RS-485)
1	DCD#	TXD422#	TXD485#
2	RXD	TXD422+	TXD485+
3	TXD	RXD422+	N/A
4	DTR#	RXD422#	N/A
5	GND	GND	GND
6	DSR#	N/A	N/A
7	RTS#	N/A	N/A
8	CTS#	N/A	N/A
9	RI#	N/A	N/A

**Table 3-9: DB-9 Connector Pinouts**



**Figure 3-22: Serial Port Pinout Location**

### 3.7.4 USB Connectors

- CN Label: USB
- CN Type: USB port
- CN Location: See **Figure 1-3**
- CN Pinouts: See **Table 3-10**

The USB ports are for connecting USB peripheral devices to the system.

**Step 1: Locate the USB connectors.** The locations of the USB connectors are shown in **Figure 1-3**.

**Step 2: Align the connectors.** Align the USB device connector with one of the connectors. See **Figure 3-23**.

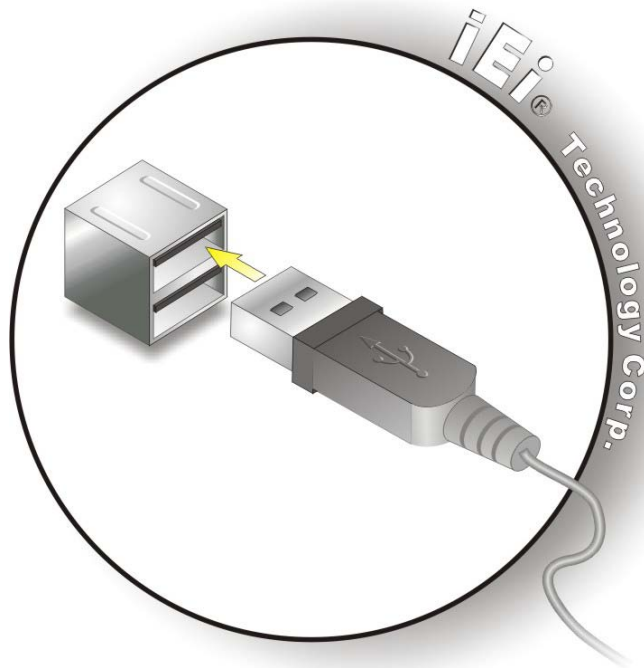

**Figure 3-23: USB Device Connection**

**Step 3: Insert the device connector.** Once aligned, gently insert the USB device connector into the USB connector on the TANK-760.

Pin	Description	Pin	Description
1	VCC	5	VCC
2	DATA-	6	DATA-
3	DATA+	7	DATA+
4	GROUND	8	GROUND

**Table 3-10: USB Port Pinouts**

### 3.7.5 VGA Connector

- CN Label: VGA
- CN Type: 15-pin Female
- CN Location: See **Figure 1-3**
- CN Pinouts: See **Figure 3-25** and **Table 3-11**

The VGA connector connects to a monitor that accepts VGA video input.

- Step 1:** **Locate the female DB-15 connector.** The location of the female DB-15 connector is shown in **Figure 1-3**.
- Step 2:** **Align the VGA connector.** Align the male DB-15 connector on the VGA screen cable with the female DB-15 connector on the external peripheral interface.
- Step 3:** **Insert the VGA connector.** Once the connectors are properly aligned with, insert the male connector from the VGA screen cable into the female connector on the TANK-760. See **Figure 3-24**.

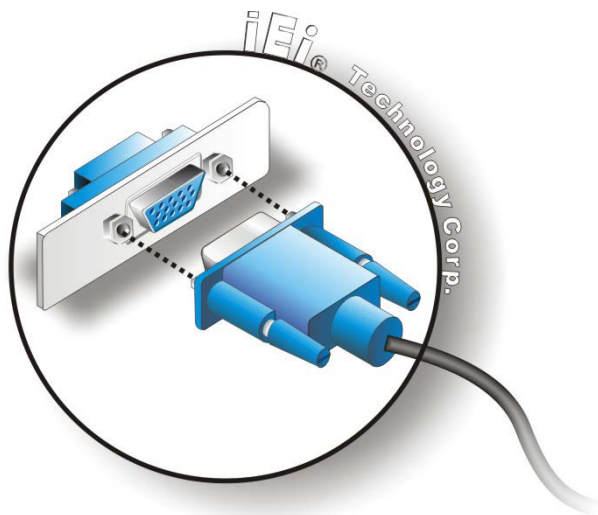

**Figure 3-24: VGA Connector**

- Step 4:** **Secure the connector.** Secure the DB-15 VGA connector from the VGA monitor to the external interface by tightening the two retention screws on either side of the connector.

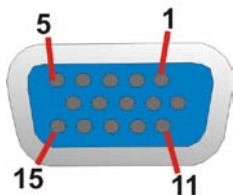

**Figure 3-25: VGA Connector**

TANK-760 Embedded System

Pin	Description	Pin	Description
1	RED	2	GREEN
3	BLUE	4	NC
5	GND	6	GND
7	GND	8	GND
9	CRT_VCC	10	Display_GND
11	NC	12	5VDDCDA
13	HSY	14	VSY
15	5VDDCLK		

Table 3-11: VGA Connector Pinouts

### 3.8 Powering On/Off the System



**WARNING:**

Make sure a power supply with the correct input voltage is being fed into the system. Incorrect voltages applied to the system may cause damage to the internal electronic components and may also cause injury to the user.

- **Power on** the system: press the power button for 3 seconds
- **Power off** the system: press the power button for 6 seconds

Power button



Figure 3-26: Power Button

### 3.9 Power

There are two power connectors on the rear panel. Power 1 connector is a 3-pin terminal block that supports ACC On signal. Power 2 connector is a DIN connector that can directly connect to a power adapter. The supported power input voltages are:

- **Power 1 (terminal block):** 9 V ~ 36 V
- **Power 2 (DC jack):** 9 V ~ 36 V



**Figure 3-27: Power Connectors**

LED Indicator	Description
<b>Power LED1 (Breathing Orange)</b>	Standby mode.
<b>Power LED2 (Solid blue)</b>	Power-on mode.

**Table 3-12: Power LED Indicators Description**



**NOTE:**

The power LED turns off when the power cable is unplugged from the system.

#### 3.9.1 ACC ON Mode

1. The TANK-760 supports single power input and also can be simultaneously connected to two power sources. When both power connectors are connected to power sources



## TANK-760 Embedded System

with 9 V~36 V power input, prior to use the corresponding power supply which with higher voltage.

2. If ACC signal is low, the system will not boot up. If ACC ON signal is high (9 V~36 V), the system will boot up and work normally.
3. If ACC signal jumps from high to low during the power on process, the system will soft shut down and shut down the system power after 10s.
4. When Power 1 < 9 V and Power 2 < 9 V, the system will soft shut down and shut down the system power after 10s.

### 3.9.2 ACC OFF Mode

1. The TANK-760 supports single power input and also can be simultaneously connected to two power sources. When both power connectors are connected to power sources with 9 V~36 V power input, prior to use the corresponding power supply which with higher voltage.
2. When Power 1 < 9 V and Power 2 < 9 V, the system will soft shut down and shut down the system power after 10s.

Chapter

4

# System Motherboard

---

## TANK-760 Embedded System

### 4.1 Overview

This chapter details all the jumpers and connectors of the system motherboard.

#### 4.1.1 Layout

The figures below show all the connectors and jumpers of the system motherboard. The Pin 1 locations of the on-board connectors are also indicated in the diagram below.

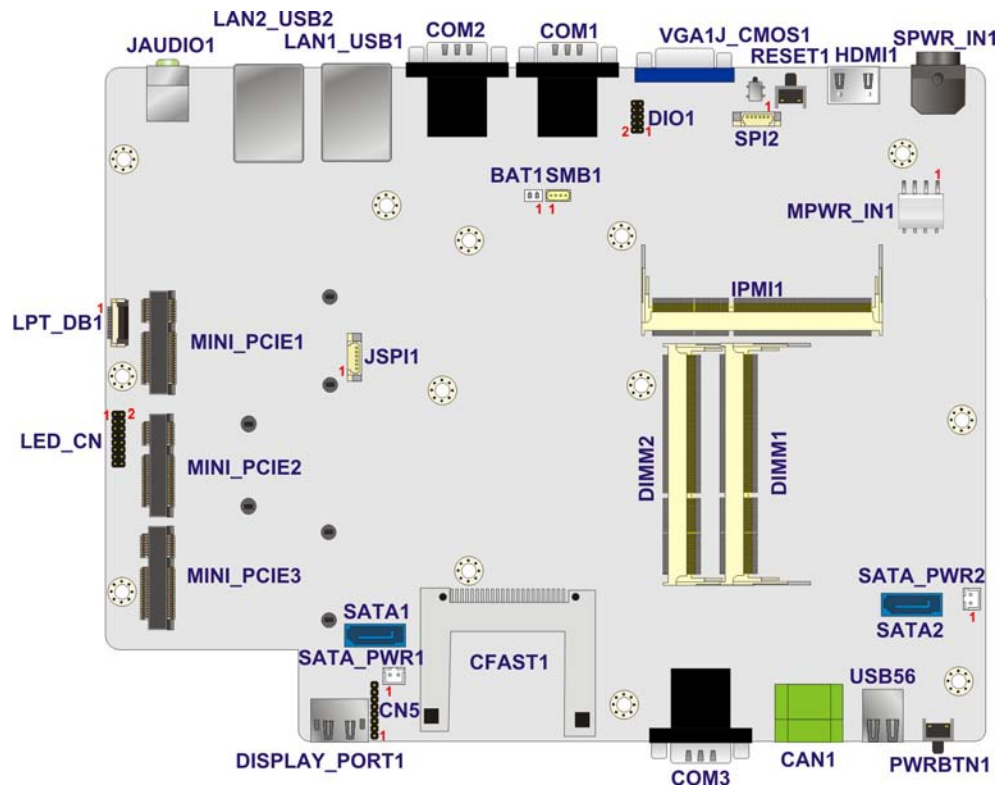
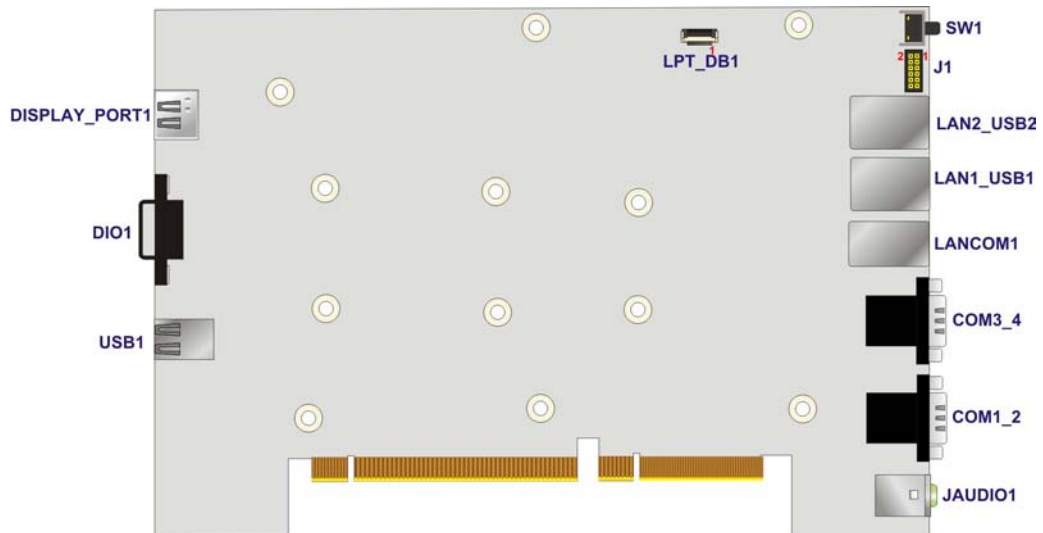

Figure 4-1: System Motherboard (Front)



**Figure 4-2: System Motherboard (Rear)**

## 4.2 Internal Peripheral Connectors

The table below shows a list of the internal peripheral interface connectors on the system motherboard. Pinouts of these connectors can be found in the following sections.

Connector	Type	Label
Clear CMOS switch	switch	J_CMOS1
Power button	button	PWRBTN1
Reset button	button	RESET1
Battery connector	2-pin wafer	BAT1
BIOS flash connector	6-pin wafer	SPI2
CFast card connector	CFast socket	CFAST1
DDR3 SO-DIMM slot	DDR3 SO-DIMM slot	DIMM1, DIMM2
DIO connector	10-pin header	DIO1
EC debug connector	20-pin FPC connector	LPT_DB1
EC flash connector	6-pin wafer	JSPI1
iRIS-2400 module slot	iRIS-2400 module slot	IPMI1

Connector	Type	Label
PCIe mini card slot	PCIe mini card slot	MINI_PCIE1, MINI_PCIE2, MINI_PCIE3
Power connector	4-pin wafer	MPWR_IN1
LED connector	16-pin header	LED_CN
SATA 6Gb/s drive connectors	7-pin SATA connector	SATA1, SATA2
SATA power connectors	2-pin wafer	SATA_PWR1, SATA_PWR2
SMBUS connector	4-pin wafer	SMB1

**Table 4-1: Peripheral Interface Connectors**

#### 4.2.1 Clear CMOS Switch (J\_CMOS1)

PIN NO.	DESCRIPTION	PIN NO.	DESCRIPTION
1	RTC_RST_N	2	GND
3	RTC_RST_N	4	GND

**Table 4-2: Clear CMOS Switch Pinouts (J\_CMOS1)**

#### 4.2.2 Power Button (PWRBTN1)

PIN NO.	DESCRIPTION	PIN NO.	DESCRIPTION
1	EX_PWRBTSW-	2	GND
3	GND	4	GND

**Table 4-3: Power Button Pinouts (PWRBTN1)**

#### 4.2.3 Reset button (RESET1)

PIN NO.	DESCRIPTION	PIN NO.	DESCRIPTION
1	EXTRST-	2	GND
3	GND	4	GND

**Table 4-4: Reset Button Pinouts (RESET1)**

#### 4.2.4 Battery Connector (BAT1)

PIN NO.	DESCRIPTION
1	VBATT
2	GND

**Table 4-5: Battery Connector Pinouts (BAT1)**

#### 4.2.5 BIOS Flash Connector (SPI2)

PIN NO.	DESCRIPTION	PIN NO.	DESCRIPTION
1	SPI_POWER	2	SPI_CS#
3	SPI_DATAIN	4	SPI_CLK
5	SPI_DATAOUT	6	GND

**Table 4-6: BIOS Flash Connector Pinouts (SPI2)**

#### 4.2.6 CFast Card connector (CFAST1)

PIN NO.	DESCRIPTION	PIN NO.	DESCRIPTION
S1	GND	S2	SATA_TX2+_C
S3	SATA_TX2-_C	S4	GND
S5	SATA_RX2-_C	S6	SATA_RX2+_C
S7	GND		
PC1	CFast_EN#	PC2	GND
PC3	NC	PC4	NC
PC5	NC	PC6	NC
PC7	GND	PC8	NC
PC9	NC	PC10	NC
PC11	NC	PC12	NC
PC13	CFAST_V3P3	PC14	CFAST_V3P3
PC15	GND	PC16	GND
PC17	GND		

**Table 4-7: CFast Card Connector Pinouts (CFAST1)**

#### 4.2.7 DIO Connector (DIO1)

PIN NO.	DESCRIPTION	PIN NO.	DESCRIPTION
1	GND	2	DIO_VCC
3	DOUT3	4	DOUT2
5	DOUT1	6	DOUT0
7	DIN3	8	DIN2
9	DIN1	10	DIN0

**Table 4-8: DIO Connector Pinouts (DIO1)**

#### 4.2.8 EC Debug Connector (LPT\_DB1)

PIN NO.	DESCRIPTION	PIN NO.	DESCRIPTION
1	KSI0	11	KSO9
2	KSO0	12	KSO10
3	KSO1	13	KSO12
4	KSO2	14	KSI1
5	KSO3	15	KSO11
6	KSO4	16	KSI2
7	KSO5	17	KSI3
8	KSO6	18	GND
9	KSO7	19	GND
10	KSO8	20	GND

**Table 4-9: EC Debug Connector Pinouts (LPT\_DB1)**

#### 4.2.9 EC Flash Connector (JSPI1)

PIN NO.	DESCRIPTION	PIN NO.	DESCRIPTION
1	SPI_POWER	2	SPI_CS#
3	SPI_SO_SW_EC	4	SPI_CLK
5	SPI_SI_SW_EC	6	GND

**Table 4-10: EC Flash Connector Pinouts (JSPI1)**

#### 4.2.10 LED Connector (LED\_CN)

PIN NO.	DESCRIPTION	PIN NO.	DESCRIPTION
1	SATA_LED	2	AT_LED
3	PWR1_LED0	4	CAN_LED1
5	PWR1_LED1	6	ATX_LED
7	PWR2_LED0	8	IPMI_LED
9	PWR2_LED1	10	CPU_LED0
11	+V3.3A_EC	12	CPU_LED1
13	+V3.3A_EC	14	+V3.3S
15	GND	16	GND

**Table 4-11: LED Connector Pinouts (J2)**

#### 4.2.11 Power Connector (MPWR\_IN1)

PIN NO.	DESCRIPTION	PIN NO.	DESCRIPTION
1	GND	2	PWRBTN_SW#
3	M_BATTERY_L	4	ACCON

**Table 4-12: Power Connector Pinouts (MPWR\_IN1)**

#### 4.2.12 SATA 6Gb/s Drive Connectors (SATA1, SATA2)

PIN NO.	DESCRIPTION	PIN NO.	DESCRIPTION
1	GND	2	SATA_TX+
3	SATA_TX-	4	GND
5	SATA_RX-	6	SATA_RX+
7	GND		

**Table 4-13: SATA 6Gb/s Drive Connectors Pinouts (SATA1, SATA2)**



#### 4.2.13 SATA Power Connectors (SATA\_PWR1, SATA\_PWR2)

PIN NO.	DESCRIPTION
1	+V5S
2	GND

**Table 4-14: SATA Power Connectors Pinouts (SATA\_PWR1, SATA\_PWR2)**

#### 4.2.14 SMBUS Connector (SMB1)

PIN NO.	DESCRIPTION	PIN NO.	DESCRIPTION
1	GND	2	SMB_DATA
3	SMB_CLK	4	+V5S

**Table 4-15: SMBUS Connector Pinouts (SMB1)**

### 4.3 External Interface Panel Connectors

The table below shows a list of the external interface panel connectors on the system motherboard. Pinouts of these connectors can be found in the following sections.

Connector	Type	Label
Audio jack (mic, line-out)	Audio jack	JAUDIO1
CANBUS connector	Terminal block	CAN1
DisplayPort connector	DisplayPort	DISPLAY_PORT1
Ethernet and USB3.0 connectors	RJ-45, USB 3.0 port	LAN1_USB1, LAN2_USB2
HDMI connector	HDMI TypeA	HDMI1
Power connector	4-pin DC jack	SPWR_IN1
RS-232 serial port connectors	DB-9	COM1&2, COM3&4
RS-232/422/485 serial port connectors	DB-9	COM5&6
CANBUS connectors	CANBUS	CAN1
USB 2.0 connectors	USB 2.0 port	USB56

Connector	Type	Label
VGA connector	DB-15	VGA1

**Table 4-16: Rear Panel Connectors**

#### 4.3.1 Audio Jack (J AUDIO1)

PIN NO.	DESCRIPTION	PIN NO.	DESCRIPTION
1	GND	2	ILMIC1-L
3	GND	4	IMIC1_JD
5	ILMIC1-R	22	ILINE_OUTL
23	GND	24	ISPK_JD
25	ILINE_OUTR		

**Table 4-17: Audio Jack Pinouts (AUDIO1)**

#### 4.3.2 CANBUS connector (CAN1)

PIN NO.	DESCRIPTION	PIN NO.	DESCRIPTION
1	CAN1H	2	CAN2H
3	CAN1L	4	CAN2L
5	GND	6	GND

**Table 4-18: CANBUS connector Pinouts (CAN1)**

#### 4.3.3 DisplayPort connector (DISPLAY\_PORT1)

PIN NO.	DESCRIPTION	PIN NO.	DESCRIPTION
1	C_DDIB_DP_DATA0	2	GND
3	C_DDIB_DP_DATA0#	4	C_DDIB_DP_DATA1
5	GND	6	C_DDIB_DP_DATA1#
7	C_DDIB_DP_DATA2	8	GND
9	C_DDIB_DP_DATA2#	10	C_DDIB_DP_DATA3
11	GND	12	C_DDIB_DP_DATA3#
13	GND	14	GND
15	C_DDIB_DP_AUXP	16	GND
17	C_DDIB_DP_AUXN	18	C_DDIB_DP_HPD

19	GND	20	VCC3_DP
21	GND	22	GND
23	GND	24	GND

**Table 4-19: DisplayPort connector Pinouts (DISPLAY\_PORT1)**

#### 4.3.4 Ethernet and USB3.0 Connectors (LAN1\_USB1)

PIN	DESCRIPTION	PIN	DESCRIPTION
1	USBVOL	10	USBVOL
2	DATA0_N	11	DATA1_N
3	DATA0_P	12	DATA1_P
4	GND	13	GND
5	USB3_RX0_N_R	14	USB3_RX1_N_R
6	USB3_RX0_P_R	15	USB3_RX1_P_R
7	GND	16	GND
8	USB3_TX0_N_R	17	USB3_TX1_N_R
9	USB3_TX0_P_R	18	USB3_TX1_P_R

**Table 4-20: USB 3.0 Port Pinouts (USB1)**

PIN	DESCRIPTION	PIN	DESCRIPTION
20	LAN_MDI0_DP	24	LAN_MDI2_DP
21	LAN_MDI0_DN	25	LAN_MDI2_DN
22	LAN_MDI1_DP	26	LAN_MDI3_DP
23	LAN_MDI1_DN	27	LAN_MDI3_DN

**Table 4-21: LAN Pinouts (LAN1)**

#### 4.3.5 Ethernet and USB3.0 Connectors (LAN2\_USB2)

PIN	DESCRIPTION	PIN	DESCRIPTION
1	USBV1L	10	USBV1L
2	DATA5_N	11	DATA6_N
3	DATA5_P	12	DATA6_P
4	GND	13	GND
5	USB3_RX2_N_R	14	USB3_RX3_N_R
6	USB3_RX2_P_R	15	USB3_RX3_P_R

PIN	DESCRIPTION	PIN	DESCRIPTION
7	GND	16	GND
8	USB3_TX2_N_R	17	USB3_TX3_N_R
9	USB3_TX2_P_R	18	USB3_TX3_P_R

**Table 4-22: USB 3.0 Port Pinouts (USB2)**

PIN	DESCRIPTION	PIN	DESCRIPTION
20	TRD2P0	24	TRD2P2
21	TRD2N0	25	TRD2N2
22	TRD2P1	26	TRD2P3
23	TRD2N1	27	TRD2N3

**Table 4-23: LAN Pinouts (LAN2)**

#### 4.3.6 HDMI Connector (HDMI1)

PIN NO.	DESCRIPTION	PIN NO.	DESCRIPTION
1	HDMI_DATA2-1_L	2	GND
3	HDMI_DATA2#-1_L	4	HDMI_DATA1-1_L
5	GND	6	HDMI_DATA1#-1_L
7	HDMI_DATA0-1_L	8	GND
9	HDMI_DATA0#-1_L	10	HDMI_CLK-1_L
11	GND	12	HDMI_CLK#-1_L
13	NC	14	NC
15	HDMI_SCL-1	16	HDMI_SDA-1
17	GND	18	+V5S
19	HDMI_HPD-1		

**Table 4-24: HDMI Connector Pinouts (HDMI1)**

#### 4.3.7 Power Connector (SPWR\_IN1)

PIN NO.	DESCRIPTION	PIN NO.	DESCRIPTION
1	POWER	2	GND
3	POWER	4	GND
5	GND		

**Table 4-25: Power Connector Pinouts (PWR2)**

4.3.8 RS-232 Serial Port Connector (COM1&2, COM3&4)

PIN NO.	DESCRIPTION	PIN NO.	DESCRIPTION
1	NDCD	2	NSIN
3	NSOUT	4	NDTR
5	GND	6	NDSR
7	NRTS	8	NCTS
9	XRI		

**Table 4-26: RS-232 Serial Port Connector Pinouts (COM1&2, COM3&4)**

4.3.9 RS-232/422/485 Serial Port Connector (COM5&6)

PIN NO.	RS232	RS422	RS485
1	DCD#	TXD422#	TXD485#
2	RXD	TXD422+	TXD485+
3	TXD	RXD422+	N/A
4	DTR#	RXD422#	N/A
5	GND	GND	GND
6	DSR#	N/A	N/A
7	RTS#	N/A	N/A
8	CTS#	N/A	N/A
9	RI#	N/A	N/A

**Table 4-27: RS-232/422/485 Serial Port Connector Pinouts (COM5&6)**

4.3.10 USB 2.0 Connectors (USB56)

PIN NO.	DESCRIPTION	PIN NO.	DESCRIPTION
1	VCC	5	VCC
2	DATA-	6	DATA-
3	DATA+	7	DATA+
4	GROUND	8	GROUND

**Table 4-28: USB 2.0 Connectors Pinouts (USB1)**

#### 4.3.11 VGA Connector (VGA1)

PIN NO.	DESCRIPTION	PIN NO.	DESCRIPTION
1	RED	2	GREEN
3	BLUE	4	GND
5	NC	6	GND
7	GND	8	GND
9	+V5_VGA	10	GND
11	NC	12	5VDDCDA
13	5HSYNC	14	5VSYNC
15	5VDDCLK		

**Table 4-29: VGA Connector Pinouts (VGA1)**

Chapter

5

**BIOS**

---

## 5.1 Introduction

The BIOS is programmed onto the BIOS chip. The BIOS setup program allows changes to certain system settings. This chapter outlines the options that can be changed.



### NOTE:

Some of the BIOS options may vary throughout the life cycle of the product and are subject to change without prior notice.

---

### 5.1.1 Starting Setup

The UEFI BIOS is activated when the computer is turned on. The setup program can be activated in one of two ways.

1. Press the **DEL** or **F2** key as soon as the system is turned on or
2. Press the **DEL** or **F2** key when the “**Press DEL or F2 to enter SETUP**” message appears on the screen.

If the message disappears before the **DEL** or **F2** key is pressed, restart the computer and try again.

### 5.1.2 Using Setup

Use the arrow keys to highlight items, press **ENTER** to select, use the PageUp and PageDown keys to change entries, press **F1** for help and press **ESC** to quit. Navigation keys are shown in the following table.

Key	Function
Up arrow	Move to previous item
Down arrow	Move to next item
Left arrow	Move to the item on the left hand side
Right arrow	Move to the item on the right hand side
+	Increase the numeric value or make changes



Key	Function
-	Decrease the numeric value or make changes
Page Up key	Move to the next page
Page Dn key	Move to the previous page
Esc key	Main Menu – Quit and not save changes into CMOS Status Page Setup Menu and Option Page Setup Menu -- Exit current page and return to Main Menu
F1	General help, only for Status Page Setup Menu and Option Page Setup Menu
F2	Load previous values
F3	Load optimized defaults
F4	Save changes and Exit BIOS

**Table 5-1: BIOS Navigation Keys**

### 5.1.3 Getting Help

When **F1** is pressed a small help window describing the appropriate keys to use and the possible selections for the highlighted item appears. To exit the Help Window press **Esc** or the **F1** key again.

### 5.1.4 Unable to Reboot after Configuration Changes

If the computer cannot boot after changes to the system configuration are made, CMOS defaults. Use the jumper described in **Chapter 4**.

### 5.1.5 BIOS Menu Bar

The **menu bar** on top of the BIOS screen has the following main items:

- Main – Changes the basic system configuration.
- Advanced – Changes the advanced system settings.
- Chipset – Changes the chipset settings.
- Boot – Changes the system boot configuration.

- Security – Sets User and Supervisor Passwords.
- Save & Exit – Selects exit options and loads default settings.

The following sections completely describe the configuration options found in the menu items at the top of the BIOS screen and listed above.

## TANK-760 Embedded System

### 5.2 Main

The **Main** BIOS menu (**BIOS Menu 1**) appears when the **BIOS Setup** program is entered.

The **Main** menu gives an overview of the basic system information.

```

Aptio Setup Utility - Copyright (C) 2012 American Megatrends, Inc.
Main  Advanced  Chipset  Boot  Security  Save & Exit
BIOS Information
BIOS Vendor                American Megatrends
Core Version                4.6.5.4
Compliance                 UEFI 2.3.1; PI 1.2
Project Version            SED3AR10.ROM
Build Date and Time        08/12/2014 16:05:00

iWDD Vendor                iEi
iWDD Version               SED3ER10.bin

IPMI Card Status           Not Present

Processor Information
Name                       Haswell
Brand String               Intel(R) Celeron(R) CPU
                           2000E @ 2.20GHz
Frequency                  2200 MHz
Processor ID                306c3
Stepping                   CO
Number of Processors       2Core(s) / 2Thread(s)
Microcode Revision         12
GT Info                     GT1 (800 MHz)

IGFX VBIOS Version         2164
Memory RC Version          1.6.1.12
Total Memory                4096 MB (DDR3)
Memory Frequency           1600 MHz

PCH Information
Name                       LynxPoint
PCH SKU                     HM86
Stepping                    05/C2
LAN PHY Revision           A3

ME FW Version              9.0.13.1402
ME Firmware SKU            1.5MB

SPI Clock Frequency
DOFR Support                Supported
Read Status Clock Frequency 50 MHz
Write Status Clock Frequency 50 MHz
Fast Read Status Clock Frequency 50 MHz

System Date                 [Tue 08/12/2014]
System Time                 [15:10:27]

Access Level                Administrator

Version 2.15.1236. Copyright (C) 2012 American Megatrends, Inc.
    
```

Set the Date. Use Tab to switch between Date elements.

-----

→←: Select Screen  
↑↓: Select Item  
Enter: Select  
+/-: Change Opt.  
F1: General Help  
F2: Previous Values  
F3: Optimized Defaults  
F4: Save & Exit  
ESC: Exit

### BIOS Menu 1: Main

- System Overview

The **BIOS Information** lists a brief summary of the BIOS. The fields in **BIOS Information** cannot be changed. The items shown in the system overview include:

- BIOS Information
- Processor Information
- Memory Information
- PCH Information
- SPI Clock Frequency

The System Overview field also has two user configurable fields:

- System Date [xx/xx/xx]

Use the **System Date** option to set the system date. Manually enter the day, month and year.

- System Time [xx:xx:xx]

Use the **System Time** option to set the system time. Manually enter the hours, minutes and seconds.

## 5.3 Advanced

Use the **Advanced** menu (**BIOS Menu 2**) to configure the CPU and peripheral devices through the following sub-menus:



### **WARNING:**

Setting the wrong values in the sections below may cause the system to malfunction. Make sure that the settings made are compatible with the hardware.

---

## TANK-760 Embedded System

```

Aptio Setup Utility - Copyright (C) 2012 American Megatrends, Inc.
Main  Advanced  Chipset  Boot  Security  Save & Exit

> ACPI Settings
> RTC Wake Settings
> CPU Configuration
> SATA Configuration
> Intel(R) Rapid Start Technology
> USB Configuration
> F81866 Super IO Configuration
> F81866 H/W Monitor
> Serial Port Console Redirection
> iEi Feature

System ACPI Parameters
-----
-><: Select Screen
↑↓: Select Item
Enter: Select
+/-: Change Opt.
F1: General Help
F2: Previous Values
F3: Optimized Defaults
F4: Save & Exit
ESC: Exit

Version 2.15.1236. Copyright (C) 2012 American Megatrends, Inc.
  
```

### BIOS Menu 2: Advanced

#### 5.3.1 ACPI Settings

The **ACPI Settings** menu (**BIOS Menu 3**) configures the Advanced Configuration and Power Interface (ACPI) options.

```

Aptio Setup Utility - Copyright (C) 2012 American Megatrends, Inc.
Advanced

ACPI Settings
ACPI Sleep State          [S1 only(CPU Stop Clock)]

Select ACPI sleep state
the system will enter
when the SUSPEND button
is pressed.
-----
-><: Select Screen
↑↓: Select Item
Enter: Select
+/-: Change Opt.
F1: General Help
F2: Previous Values
F3: Optimized Defaults
F4: Save & Exit
ESC: Exit

Version 2.15.1236. Copyright (C) 2012 American Megatrends, Inc.
  
```

### BIOS Menu 3: ACPI Settings

- ACPI Sleep State [S1 only (CPU Stop Clock)]

Use the **ACPI Sleep State** option to specify the sleep state the system enters when it is not being used.

- ➔ **S1 only (CPU Stop Clock)** **DEFAULT** The system enters S1 (POS) sleep state. The system appears off. The CPU is stopped; RAM is refreshed; the system is running in a low power mode.
- ➔ **S3 only (Suspend to RAM)** The caches are flushed and the CPU is powered off. Power to the RAM is maintained. The computer returns slower to a working state, but more power is saved.

### 5.3.2 RTC Wake Settings

The **RTC Wake Settings** menu (**BIOS Menu 4**) enables the system to wake at the specified time.

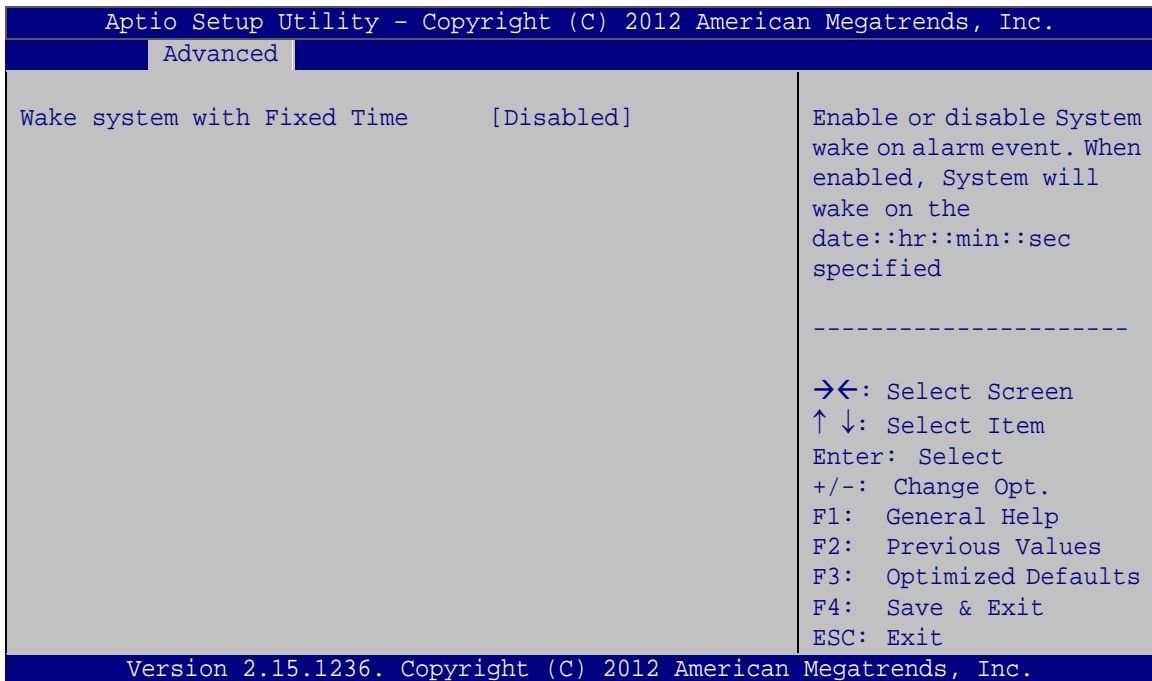

**BIOS Menu 4: RTC Wake Settings**

## TANK-760 Embedded System

- Wake system with Fixed Time [Disabled]

Use the **Wake system with Fixed Time** option to enable or disable the system wake on alarm event.

→ **Disabled**      **DEFAULT**      The real time clock (RTC) cannot generate a wake event

→ **Enabled**      If selected, the **Wake up every day** option appears allowing you to enable to disable the system to wake every day at the specified time. Besides, the following options appear with values that can be selected:

Wake up every day

Wake up date

Wake up hour

Wake up minute

Wake up second

After setting the alarm, the computer turns itself on from a suspend state when the alarm goes off.

### 5.3.3 CPU Configuration

Use the **CPU Configuration** menu (**BIOS Menu 5**) to view detailed CPU specifications and configure the CPU.

```

Aptio Setup Utility - Copyright (C) 2012 American Megatrends, Inc.
  Advanced
CPU Configuration
Intel(R) Celeron(R) CPU 2000E @ 2.20GHz
CPU Signature          306c3
Microcode Patch       12
Max CPU Speed         2200 MHz
Min CPU Speed         800 MHz
CPU Speed             2200 MHz
Processor Cores       2
Intel HT Technology    Not Supported
Intel VT-x Technology Supported
Intel SMX Technology  Not Supported
64-bit                Supported
EIST Technology        Supported

L1 Data Cache         32 kB x 2
L1 Code Cache         32 kB x 2
L2 Cache              256 kB x 2
L3 Cache              2048 kB

Active Processor Cores [All]
Intel Virtualization Technology [Disabled]
EIST                  [Enabled]

Enabled for Windows XP and Linux (OS optimized for Hyper-Threading Technology) and Disabled for other OS (OS not optimized for Hyper-Threading Technology). When Disabled only one thread per enabled core is enabled.

-----
-><: Select Screen
↑ ↓: Select Item
Enter: Select
+/-: Change Opt.
F1: General Help
F2: Previous Values
F3: Optimized Defaults
F4: Save & Exit
ESC: Exit

Version 2.15.1236. Copyright (C) 2012 American Megatrends, Inc.
    
```

#### BIOS Menu 5: CPU Configuration

The CPU Configuration menu (**BIOS Menu 5**) lists the following CPU details:

- Processor Type: Lists the brand name of the CPU being used
- CPU Signature: Lists the CPU signature value.
- Microcode Patch: Lists the microcode patch being used.
- Max CPU Speed: Lists the maximum CPU processing speed.
- Min CPU Speed: Lists the minimum CPU processing speed.
- CPU Speed: Lists the CPU processing speed
- Processor Cores: Lists the number of the processor core
- Intel HT Technology: Indicates if Intel HT Technology is supported by the CPU.





### 5.3.4 SATA Configuration

Use the **SATA Configuration** menu (**BIOS Menu 6**) to change and/or set the configuration of the SATA devices installed in the system.

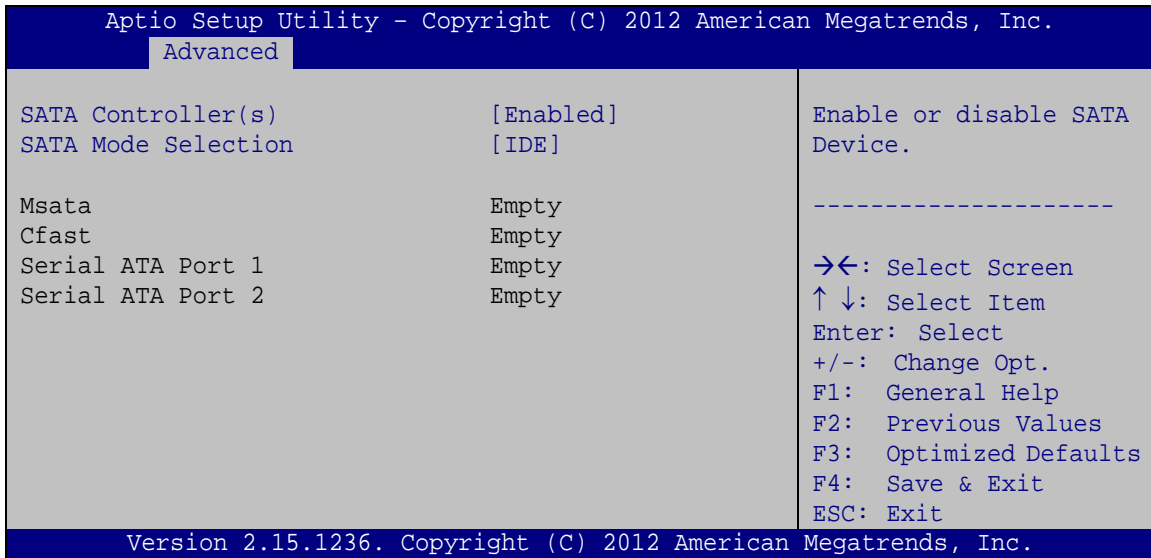

#### BIOS Menu 6: SATA Configuration

- SATA Controller(s) [Enabled]

Use the **SATA Controller(s)** option to configure the SATA controller.

- **Enabled**      **DEFAULT**      Enable SATA controller.
- **Disabled**                      Disable SATA controller.

- SATA Mode Selection [IDE]

Use the **SATA Mode Selection** option to configure SATA devices.

- **IDE**              **DEFAULT**      Configures SATA devices as normal IDE device.
- **AHCI**                              Configures SATA devices as AHCI device.

## TANK-760 Embedded System

### 5.3.5 Intel(R) Rapid Start Technology

Use the **Intel(R) Rapid Start Technology (BIOS Menu 7)** menu to configure Intel® Rapid Start Technology support.

```

Aptio Setup Utility - Copyright (C) 2012 American Megatrends, Inc.
-----
Advanced
-----
Intel(R) Rapid Start Technology    [Disabled]
                                     Enable or disable
                                     Intel(R) Rapid Start
                                     Technology
                                     -----
                                     →←: Select Screen
                                     ↑↓: Select Item
                                     Enter: Select
                                     +/-: Change Opt.
                                     F1:  General Help
                                     F2:  Previous Values
                                     F3:  Optimized Defaults
                                     F4:  Save & Exit
                                     ESC: Exit
-----
Version 2.15.1236. Copyright (C) 2012 American Megatrends, Inc.
    
```

#### BIOS Menu 7: Intel(R) Rapid Start Technology

- Intel(R) Rapid Start Technology [Disabled]

Use **Intel(R) Rapid Start Technology** option to enable or disable the Intel® Rapid Start Technology function.

- ➔ **Disabled**      **DEFAULT**      Intel® Rapid Start Technology is disabled
- ➔ **Enabled**                      Intel® Rapid Start Technology is enabled

### 5.3.6 USB Configuration

Use the **USB Configuration** menu (**BIOS Menu 8**) to read USB configuration information and configure the USB settings.

```

Aptio Setup Utility - Copyright (C) 2012 American Megatrends, Inc.
  Advanced
USB Configuration
USB Devices:
  1 Keyboard, 2 Hubs
Legacy USB Support          [Enabled]
-----
-><: Select Screen
↑↓: Select Item
Enter: Select
+/-: Change Opt.
F1: General Help
F2: Previous Values
F3: Optimized Defaults
F4: Save & Exit
ESC: Exit
Version 2.15.1236. Copyright (C) 2012 American Megatrends, Inc.

```

#### BIOS Menu 8: USB Configuration

- USB Devices

The **USB Devices** field lists the USB devices that are enabled on the system

- Legacy USB Support [Enabled]

Use the **Legacy USB Support** BIOS option to enable USB mouse and USB keyboard support.

Normally if this option is not enabled, any attached USB mouse or USB keyboard does not become available until a USB compatible operating system is fully booted with all USB drivers loaded. When this option is enabled, any attached USB mouse or USB keyboard can control the system even when there is no USB driver loaded onto the system.

## TANK-760 Embedded System

- ➔ **Enabled**      **DEFAULT**      Legacy USB support enabled
- ➔ **Disabled**                      Legacy USB support disabled
- ➔ **Auto**                              Legacy USB support disabled if no USB devices are connected

### 5.3.7 F81866 Super IO Configuration

Use the **F81866 Super IO Configuration** menu (**BIOS Menu 9**) to set or change the configurations for the serial ports.

```

Aptio Setup Utility - Copyright (C) 2012 American Megatrends, Inc.
  Advanced
F81866 Super IO Configuration
F81866 Super IO Chip          F81866
> Serial Port 1 Configuration
> Serial Port 2 Configuration
> Serial Port 3 Configuration
> Serial Port 4 Configuration
> Serial Port 5 Configuration
> Serial Port 6 Configuration
Set Parameters of Serial
Port 1 (COMA)
-----
-><: Select Screen
↑↓: Select Item
Enter: Select
+/-: Change Opt.
F1: General Help
F2: Previous Values
F3: Optimized Defaults
F4: Save & Exit
ESC: Exit
Version 2.15.1236. Copyright (C) 2012 American Megatrends, Inc.
  
```

### BIOS Menu 9: F81866 Super IO Configuration

### 5.3.7.1 Serial Port n Configuration

Use the **Serial Port n Configuration** menu (**BIOS Menu 10**) to configure the serial port n.

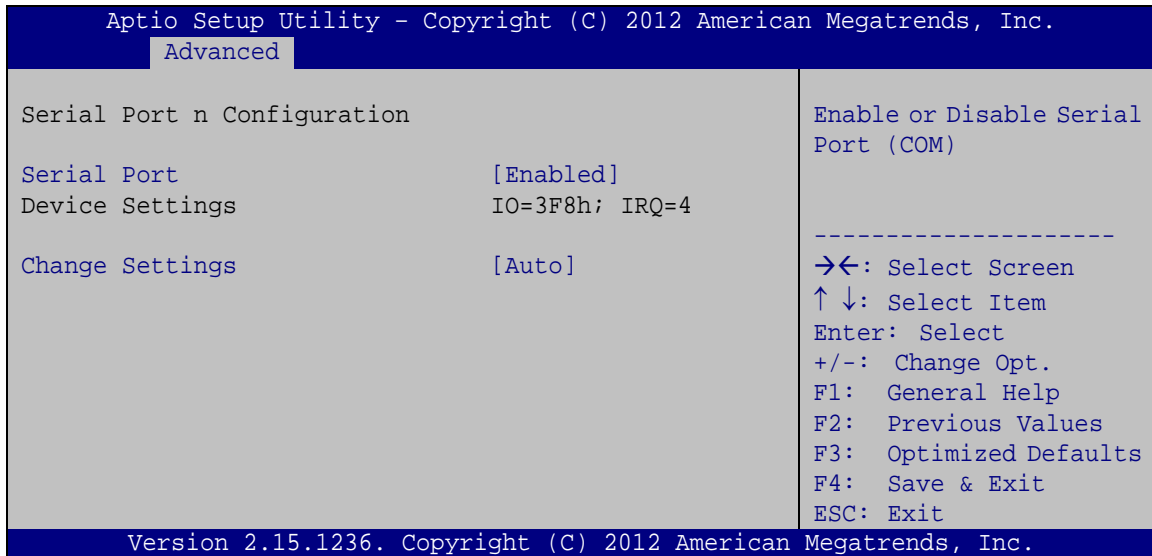

#### BIOS Menu 10: Serial Port n Configuration Menu

##### 5.3.7.1.1 Serial Port 1 Configuration

- Serial Port [Enabled]

Use the **Serial Port** option to enable or disable the serial port.

- ➔ **Disabled** Disable the serial port
- ➔ **Enabled** **DEFAULT** Enable the serial port

- Change Settings [Auto]

Use the **Change Settings** option to change the serial port IO port address and interrupt address.

- ➔ **Auto** **DEFAULT** The serial port IO port address and interrupt address are automatically detected.
- ➔ **IO=3F8h;**  
**IRQ=4** Serial Port I/O port address is 3F8h and the interrupt address is IRQ4

## TANK-760 Embedded System

- ➔ **IO=3F8h;**                      Serial Port I/O port address is 3F8h and the interrupt  
**IRQ=3, 4**                      address is IRQ3, 4
- ➔ **IO=2F8h;**                      Serial Port I/O port address is 2F8h and the interrupt  
**IRQ=3, 4**                      address is IRQ3, 4

### 5.3.7.1.2 Serial Port 2 Configuration

- Serial Port [Enabled]

Use the **Serial Port** option to enable or disable the serial port.

- ➔ **Disabled**                      Disable the serial port
- ➔ **Enabled**                      **DEFAULT**                      Enable the serial port

- Change Settings [Auto]

Use the **Change Settings** option to change the serial port IO port address and interrupt address.

- ➔ **Auto**                      **DEFAULT**                      The serial port IO port address and interrupt address  
are automatically detected.
- ➔ **IO=2F8h;**                      Serial Port I/O port address is 2F8h and the interrupt  
**IRQ=3**                      address is IRQ3
- ➔ **IO=3F8h;**                      Serial Port I/O port address is 3F8h and the interrupt  
**IRQ=3, 4**                      address is IRQ3, 4
- ➔ **IO=2F8h;**                      Serial Port I/O port address is 2F8h and the interrupt  
**IRQ=3, 4**                      address is IRQ3, 4

### 5.3.7.1.3 Serial Port 3 Configuration

- Serial Port [Enabled]

Use the **Serial Port** option to enable or disable the serial port.

- ➔ **Disabled**                      Disable the serial port

➔ **Enabled**      **DEFAULT**      Enable the serial port

- Change Settings [Auto]

Use the **Change Settings** option to change the serial port IO port address and interrupt address.

➔ **Auto**      **DEFAULT**      The serial port IO port address and interrupt address are automatically detected.

➔ **IO=3E8h;**  
**IRQ=10**      Serial Port I/O port address is 3E8h and the interrupt address is IRQ10

➔ **IO=3E8h;**  
**IRQ=10, 11**      Serial Port I/O port address is 3E8h and the interrupt address is IRQ10, 11

➔ **IO=2E8h;**  
**IRQ=10, 11**      Serial Port I/O port address is 2E8h and the interrupt address is IRQ10, 11

#### 5.3.7.1.4 Serial Port 4 Configuration

- Serial Port [Enabled]

Use the **Serial Port** option to enable or disable the serial port.

➔ **Disabled**      Disable the serial port

➔ **Enabled**      **DEFAULT**      Enable the serial port

- Change Settings [Auto]

Use the **Change Settings** option to change the serial port IO port address and interrupt address.

➔ **Auto**      **DEFAULT**      The serial port IO port address and interrupt address are automatically detected.

➔ **IO=2E8h;**  
**IRQ=10**      Serial Port I/O port address is 2E8h and the interrupt address is IRQ10



## TANK-760 Embedded System

- ➔ **IO=3E8h;**  
**IRQ=10, 11**      Serial Port I/O port address is 3E8h and the interrupt address is IRQ10, 11
- ➔ **IO=2E8h;**  
**IRQ=10, 11**      Serial Port I/O port address is 2E8h and the interrupt address is IRQ10, 11

### 5.3.7.1.5 Serial Port 5 Configuration

- Serial Port [Enabled]

Use the **Serial Port** option to enable or disable the serial port.

- ➔ **Disabled**      Disable the serial port
- ➔ **Enabled**      **DEFAULT**      Enable the serial port

- Change Settings [Auto]

Use the **Change Settings** option to change the serial port IO port address and interrupt address.

- ➔ **Auto**      **DEFAULT**      The serial port IO port address and interrupt address are automatically detected.
- ➔ **IO=2D0h;**  
**IRQ=10**      Serial Port I/O port address is 2D0h and the interrupt address is IRQ10
- ➔ **IO=2D0h;**  
**IRQ=10, 11**      Serial Port I/O port address is 2D0h and the interrupt address is IRQ10, 11
- ➔ **IO=2D8h;**  
**IRQ=10, 11**      Serial Port I/O port address is 2D8h and the interrupt address is IRQ10, 11

- ➔ Device Mode [RS232]

Use the **Device Mode** option to enable or disable the serial port.

- ➔ **RS232**      **DEFAULT**      Enables serial port RS-232 support.
- ➔ **RS422**      Enables serial port RS-422 support.

- ➔ **RS485**                      Enables serial port RS-485 support.

### 5.3.7.1.6 Serial Port 6 Configuration

- Serial Port [Enabled]

Use the **Serial Port** option to enable or disable the serial port.

- ➔ **Disabled**                      Disable the serial port
- ➔ **Enabled**            **DEFAULT**            Enable the serial port

- Change Settings [Auto]

Use the **Change Settings** option to change the serial port IO port address and interrupt address.

- ➔ **Auto**                      **DEFAULT**            The serial port IO port address and interrupt address are automatically detected.
- ➔ **IO=2D8h;**  
**IRQ=10**                      Serial Port I/O port address is 2D8h and the interrupt address is IRQ10
- ➔ **IO=2D0h;**  
**IRQ=10, 11**                      Serial Port I/O port address is 2D0h and the interrupt address is IRQ10, 11
- ➔ **IO=2D8h;**  
**IRQ=10, 11**                      Serial Port I/O port address is 2D8h and the interrupt address is IRQ10, 11

- ➔ Device Mode [RS232]

Use the **Device Mode** option to enable or disable the serial port.

- ➔ **RS232**                      **DEFAULT**            Enables serial port RS-232 support.
- ➔ **RS422**                      Enables serial port RS-422 support.
- ➔ **RS485**                      Enables serial port RS-485 support.

## TANK-760 Embedded System

## 5.3.8 F81866 H/W Monitor

The **F81866 H/W Monitor** menu (**BIOS Menu 11**) displays the CPU temperature and system temperature.

```

Aptio Setup Utility - Copyright (C) 2012 American Megatrends, Inc.
Advanced
PC Health Status
CPU temperature           : +59 C
System temperature       : +48 C
Smart Fan Mode Select
-----
-><: Select Screen
↑↓: Select Item
Enter: Select
+/-: Change Opt.
F1: General Help
F2: Previous Values
F3: Optimized Defaults
F4: Save & Exit
ESC: Exit
Version 2.15.1236. Copyright (C) 2012 American Megatrends, Inc.

```

**BIOS Menu 11: iWDD H/W Monitor**

- PC Health Status

The following system parameters and values are shown. The system parameters that are monitored are:

- CPU Temperature
- System Temperature

## 5.3.9 Serial Port Console Redirection

The **Serial Port Console Redirection** menu (**BIOS Menu 12**) allows the console redirection options to be configured. Console redirection allows users to maintain a system remotely by re-directing keyboard input and text output through the serial port.

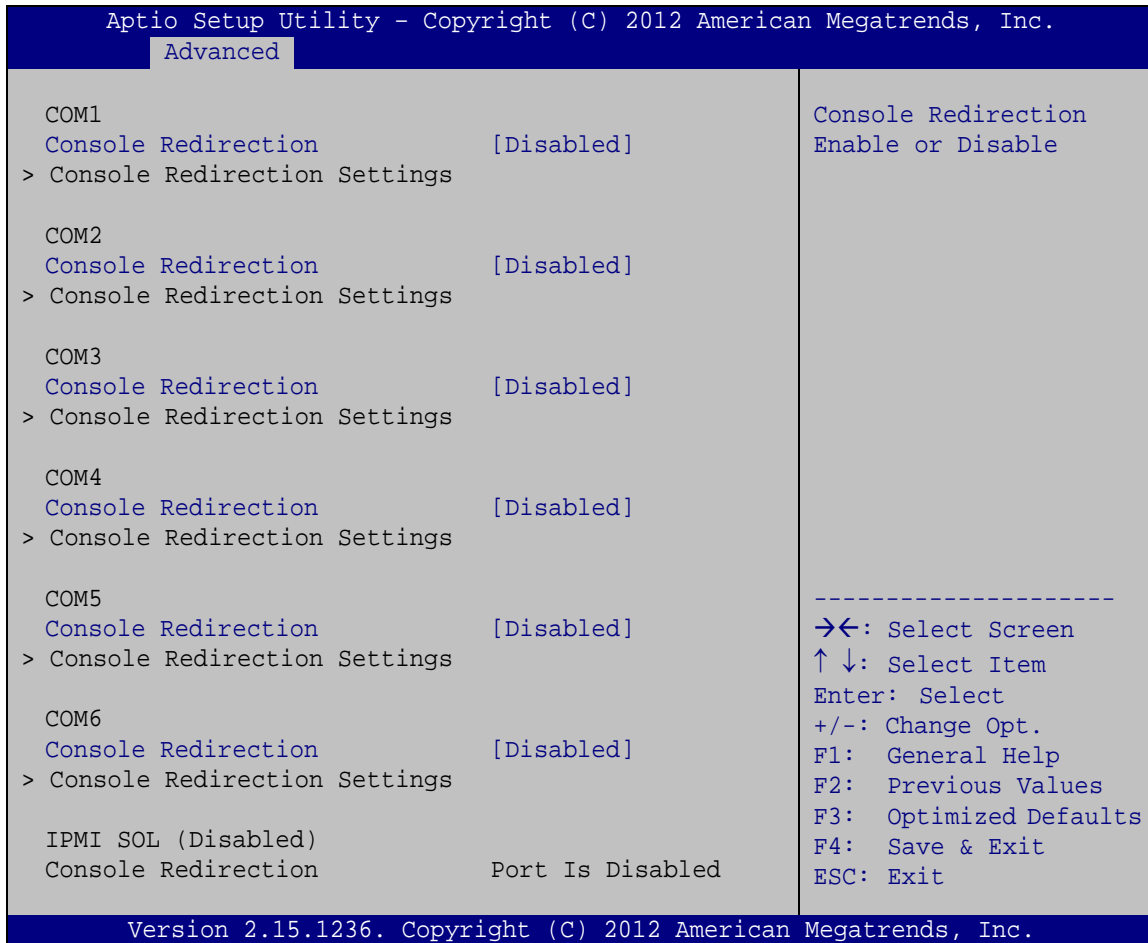

### BIOS Menu 12: Serial Port Console Redirection

- Console Redirection [Disabled]

Use **Console Redirection** option to enable or disable the console redirection function.

- ➔ **Disabled**     **DEFAULT**     Disabled the console redirection function
- ➔ **Enabled**                     Enabled the console redirection function



#### NOTE:

The following five options appear when the Console Redirection option is enabled.

## TANK-760 Embedded System

## ▪ Terminal Type [ANSI]

Use the **Terminal Type** option to specify the remote terminal type.

- ➔ **VT100**                      The target terminal type is VT100
- ➔ **VT100+**                    The target terminal type is VT100+
- ➔ **VT-UTF8**                    The target terminal type is VT-UTF8
- ➔ **ANSI**                    **DEFAULT**                    The target terminal type is ANSI

## ▪ Bits per second [115200]

Use the **Bits per second** option to specify the serial port transmission speed. The speed must match the other side. Long or noisy lines may require lower speeds.

- ➔ **9600**                      Sets the serial port transmission speed at 9600.
- ➔ **19200**                      Sets the serial port transmission speed at 19200.
- ➔ **38400**                      Sets the serial port transmission speed at 38400.
- ➔ **57600**                      Sets the serial port transmission speed at 57600.
- ➔ **115200**                    **DEFAULT**                    Sets the serial port transmission speed at 115200.

## ▪ Data Bits [8]

Use the **Data Bits** option to specify the number of data bits.

- ➔ **7**                              Sets the data bits at 7.
- ➔ **8**                              **DEFAULT**                    Sets the data bits at 8.

## ▪ Parity [None]

Use the **Parity** option to specify the parity bit that can be sent with the data bits for detecting the transmission errors.

- ➔ **None**                    **DEFAULT**                    No parity bit is sent with the data bits.

- **Even**                      The parity bit is 0 if the number of ones in the data bits is even.
- **Odd**                      The parity bit is 0 if the number of ones in the data bits is odd.
- **Mark**                      The parity bit is always 1. This option does not provide error detection.
- **Space**                      The parity bit is always 0. This option does not provide error detection.

- Stop Bits [1]

Use the **Stop Bits** option to specify the number of stop bits used to indicate the end of a serial data packet. Communication with slow devices may require more than 1 stop bit.

- **1**                      **DEFAULT**                      Sets the number of stop bits at 1.
- **2**                                           Sets the number of stop bits at 2.

## TANK-760 Embedded System

### 5.3.10 iEi Feature

Use the **iEi Feature** menu (**BIOS Menu 13**) to configure One Key Recovery function.

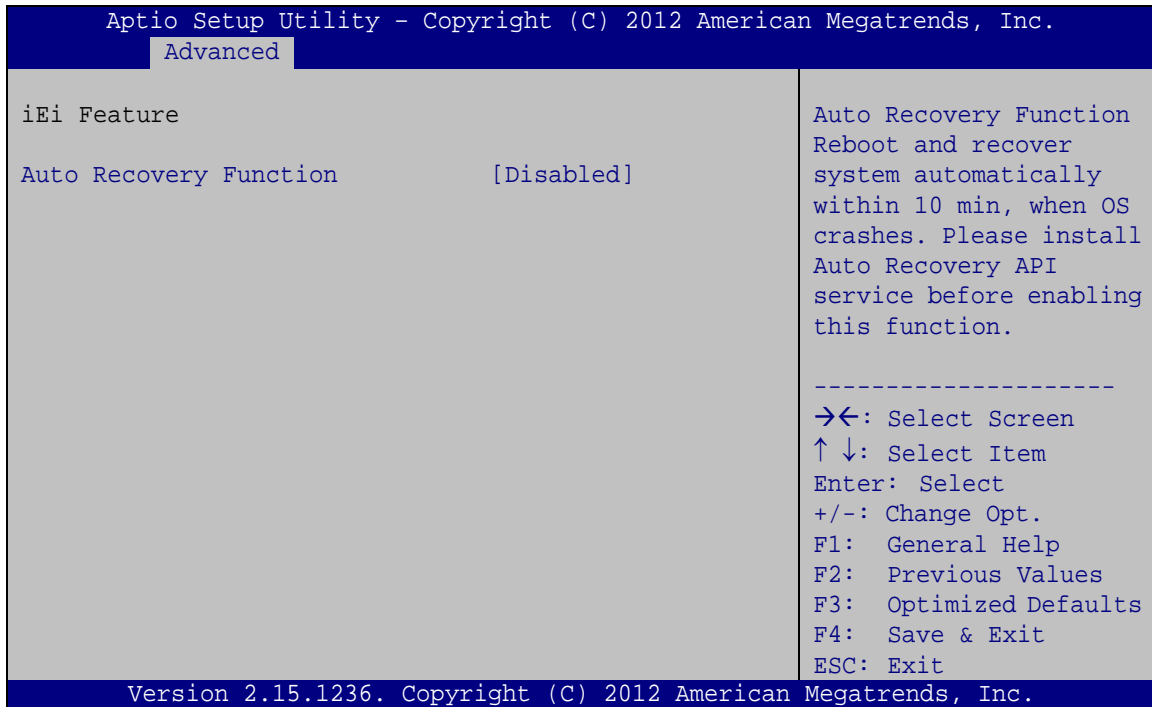

#### BIOS Menu 13: iEi Feature

- Auto Recovery Function [Disabled]

Use the **Auto Recovery Function** BIOS option to enable or disable the auto recovery function of the IEI One Key Recovery.

- ➔ **Disabled**     **DEFAULT**     Auto recovery function disabled
- ➔ **Enabled**     Auto recovery function enabled

## 5.4 Chipset

Use the **Chipset** menu (**BIOS Menu 14**) to access the PCH IO and System Agent (SA) configuration menus.



### WARNING!

Setting the wrong values for the Chipset BIOS selections in the Chipset BIOS menu may cause the system to malfunction.

```
Aptio Setup Utility - Copyright (C) 2012 American Megatrends, Inc.
Main   Advanced  Chipset  Boot   Security  Save & Exit
-----
> PCH-IO Configuration          PCH Parameters
> System Agent (SA) Configuration
-----
-><: Select Screen
↑↓: Select Item
Enter: Select
+/-: Change Opt.
F1: General Help
F2: Previous Values
F3: Optimized Defaults
F4: Save & Exit
ESC: Exit

Version 2.15.1236. Copyright (C) 2012 American Megatrends, Inc.
```

### BIOS Menu 14: Chipset



## TANK-760 Embedded System

### 5.4.1 PCH-IO Configuration

Use the **PCH-IO Configuration** menu (**BIOS Menu 15**) to configure the PCH parameters.

```

Aptio Setup Utility - Copyright (C) 2012 American Megatrends, Inc.
Chipset
Auto Power Button Status      [ATX]
Restore AC Power Loss         [Last State]
Power Saving Function(ERP)    [Disabled]
USB_Power_SW1                [5V_Dual]

> PCH Azalia Configuration

-----
-><: Select Screen
↑↓: Select Item
Enter: Select
+/-: Change Opt.
F1: General Help
F2: Previous Values
F3: Optimized Defaults
F4: Save & Exit
ESC: Exit

Version 2.15.1236. Copyright (C) 2012 American Megatrends, Inc.

```

#### BIOS Menu 15: PCH-IO Configuration

- Restore AC Power Loss [Last State]

Use the **Restore AC Power Loss** BIOS option to specify what state the system returns to if there is a sudden loss of power to the system.

- ➔ **Power Off**                      The system remains turned off
- ➔ **Power On**                        The system turns on
- ➔ **Last State**            **DEFAULT**    The system returns to its previous state. If it was on, it turns itself on. If it was off, it remains off.

- Power Saving Function [Disabled]

Use the **Power Saving Function** option to enable or disable power saving function.

- ➔ **Disabled**    **DEFAULT**    Power saving function is disabled
- ➔ **Enabled**                      Enable to reduce power consumption in system off state.

- USB Power SW1 [5V\_DUAL]

Use the **USB Power SW1** BIOS option to configure the power of USB port by software.

- ➔ **5V\_DUAL**      **DEFAULT**      Sets to +5V DUAL
- ➔ **5V**                                      Sets to +5V

#### 5.4.1.1 PCH Azalia Configuration

Use the **PCH Azalia Configuration** menu (**BIOS Menu 16**) to configure the PCH Azalia settings.

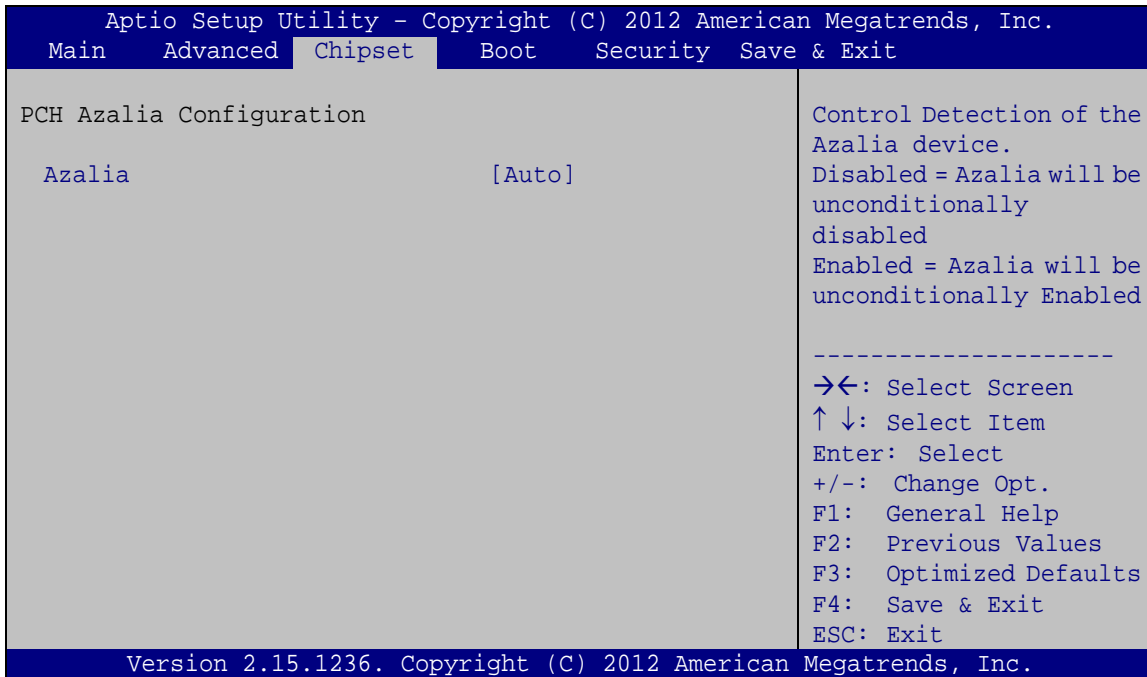

#### BIOS Menu 16: PCH Azalia Configuration Menu

- ➔ Azalia [Enabled]

Use the **Azalia** option to enable or disable the High Definition Audio controller.

- ➔ **Disabled**                      The onboard High Definition Audio controller is disabled
- ➔ **Enabled**      **DEFAULT**      The onboard High Definition Audio controller automatically detected and enabled

## TANK-760 Embedded System

➔ **Auto**     **DEFAULT**     The onboard High Definition Audio controller automatically detected and enabled

### 5.4.2 System Agent (SA) Configuration

Use the **System Agent (SA) Configuration** menu (**BIOS Menu 17**) to configure the System Agent (SA) parameters.

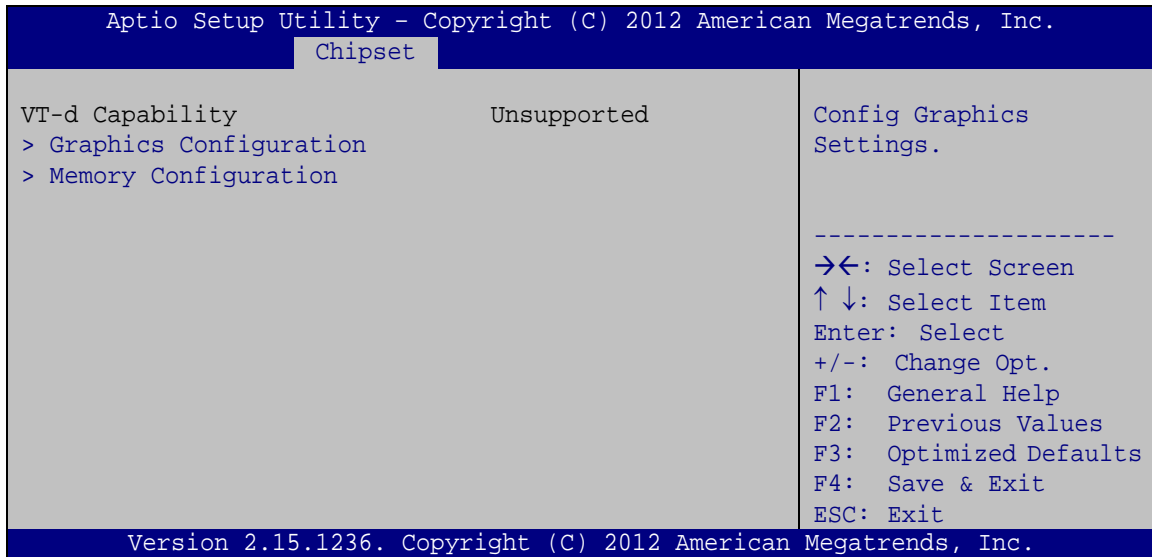

#### **BIOS Menu 17: System Agent (SA) Configuration**

##### 5.4.2.1 Graphics Configuration

Use the **Graphics Configuration (BIOS Menu 18)** menu to configure the video device connected to the system.

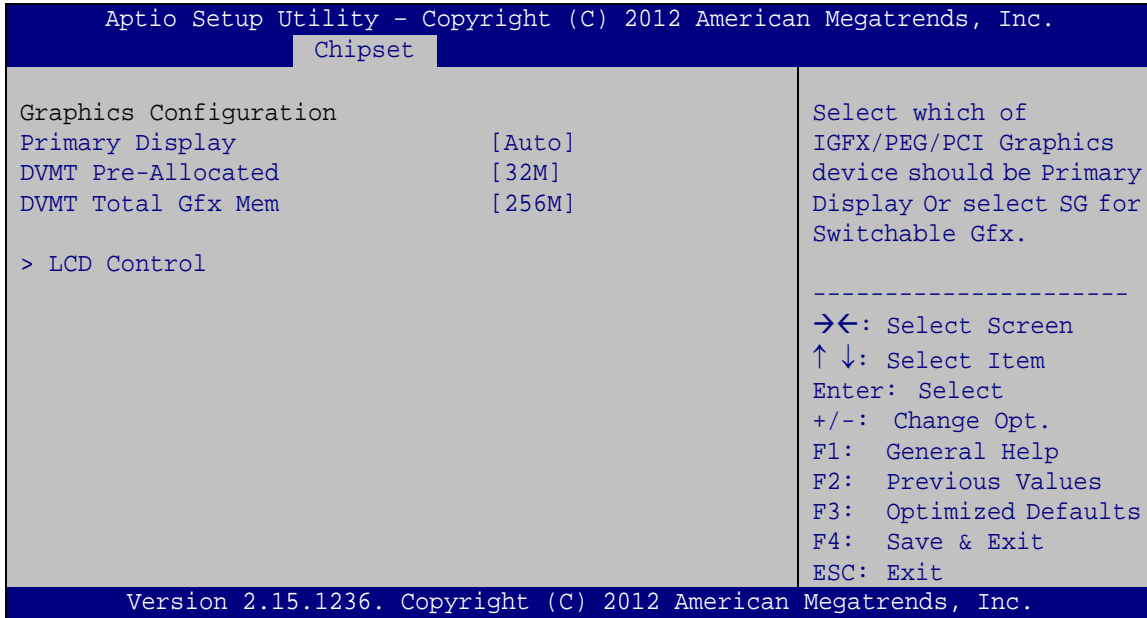

### BIOS Menu 18: Graphics Configuration

- Primary Display [Auto]

Use the **Primary Display** option to select the primary graphics controller the system uses.

The following options are available:

- Auto **Default**
- IGFX
- PEG
- PCIE
- SG

- DVMT Pre-Allocated [32M]

Use the **DVMT Pre-Allocated** option to set the amount of system memory allocated to the integrated graphics processor when the system boots. The system memory allocated can then only be used as graphics memory, and is no longer available to applications or the operating system. Configuration options are listed below:

- 32M **Default**
- 64M
- 128M
- 256M

## TANK-760 Embedded System

- 512M
  
- DVMT Total Gfx Mem [256M]

Use the **DVMT Total Gfx Mem** option to select DVMT5.0 total graphic memory size used by the internal graphic device. The following options are available:

- 128M
- 256M                      **Default**
- MAX

### 5.4.2.1.1 LCD Control

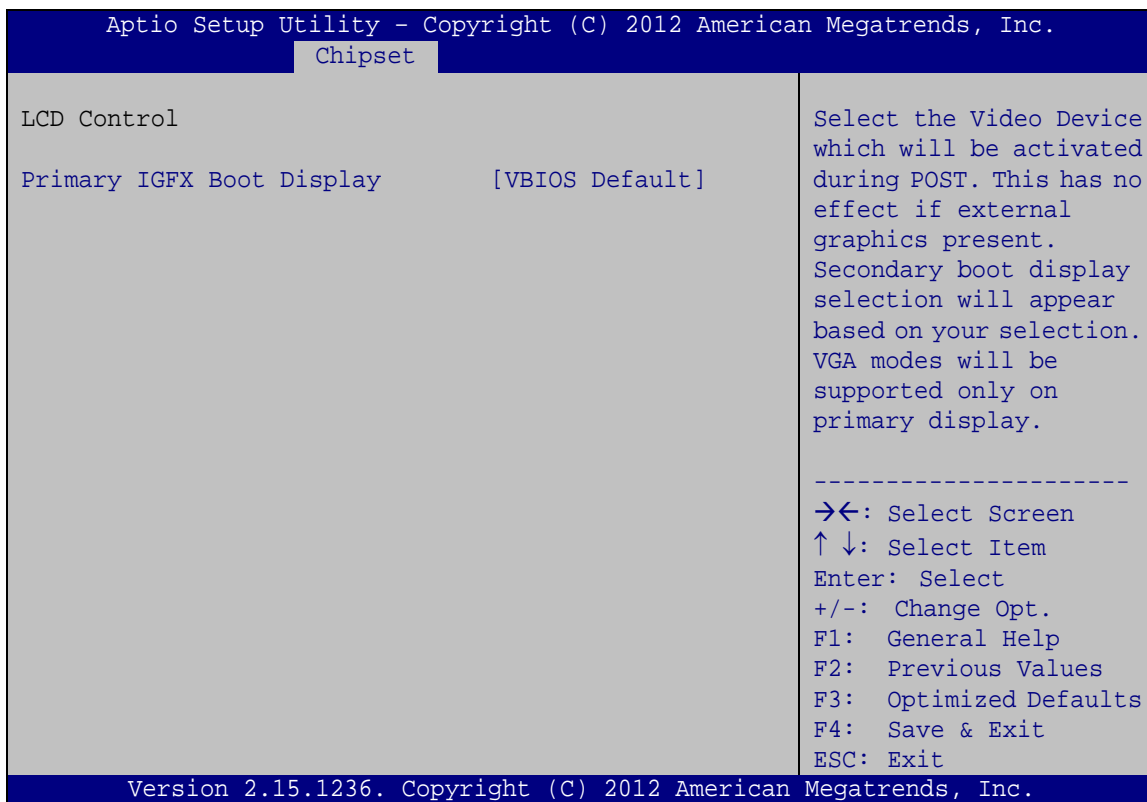

#### BIOS Menu 19: LCD Control

➔ Primary IGFX Boot Display [VBIOS Default]

Use the **Primary IGFX Boot Display** option to select the display device used by the system when it boots. Configuration options are listed below.

- VBIOS                      **DEFAULT**
- CRT

- Display port 1
- HDMI

### 5.4.2.2 Memory Configuration

Use the **Memory Configuration** submenu (**BIOS Menu 20**) to view memory information.

```
Aptio Setup Utility - Copyright (C) 2012 American Megatrends, Inc.
Chipset
Memory Information
Memory Frequency          1600 Mhz
Total Memory              4096 MB (DDR3)
DIMM#1                   4096 MB (DDR3)
DIMM#2                   Not Present
-----
-><: Select Screen
↑↓: Select Item
Enter: Select
+/-: Change Opt.
F1:  General Help
F2:  Previous Values
F3:  Optimized Defaults
F4:  Save & Exit
ESC: Exit
Version 2.15.1236. Copyright (C) 2012 American Megatrends, Inc.
```

**BIOS Menu 20: Memory Configuration**

## 5.5 Boot

Use the **Boot menu (BIOS Menu 21)** to configure system boot options.

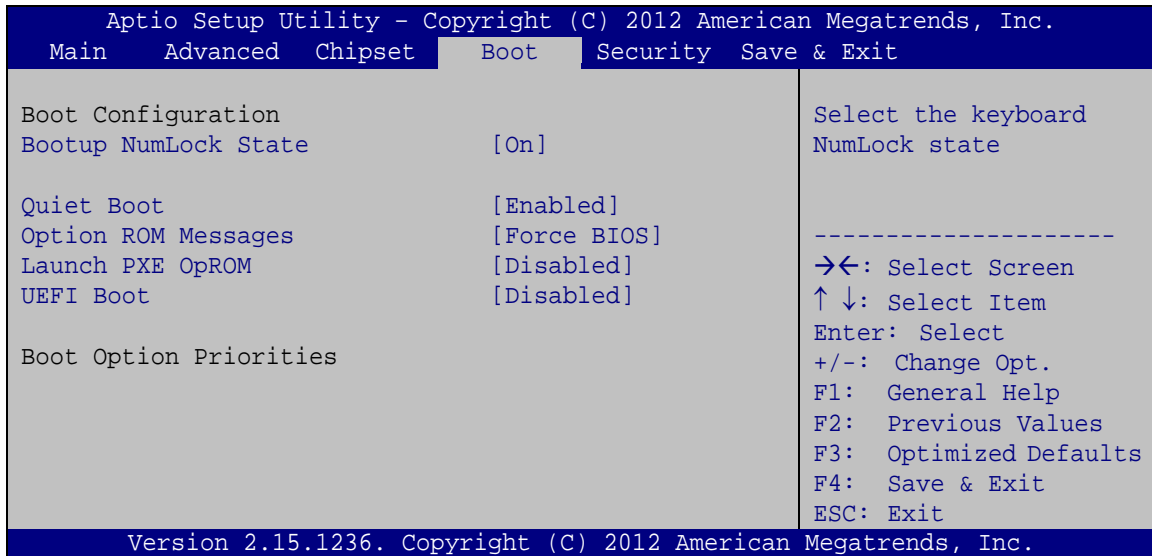

### BIOS Menu 21: Boot

- Bootup NumLock State [On]

Use the **Bootup NumLock State** BIOS option to specify if the number lock setting must be modified during boot up.

- **On**                      **DEFAULT**                      Allows the Number Lock on the keyboard to be enabled automatically when the computer system boots up. This allows the immediate use of the 10-key numeric keypad located on the right side of the keyboard. To confirm this, the Number Lock LED light on the keyboard is lit.
  
- **Off**                                      Does not enable the keyboard Number Lock automatically. To use the 10-keys on the keyboard, press the Number Lock key located on the upper left-hand corner of the 10-key pad. The Number Lock LED on the keyboard lights up when the Number Lock is engaged.

- Quiet Boot [Enabled]

Use the **Quiet Boot** BIOS option to select the screen display when the system boots.

- ➔ **Disabled** Normal POST messages displayed
- ➔ **Enabled** **DEFAULT** OEM Logo displayed instead of POST messages

- Option ROM Messages [Force BIOS]

Use the **Option ROM Messages** option to set the Option ROM display mode.

- ➔ **Force BIOS** **DEFAULT** Sets display mode to force BIOS.
- ➔ **Keep Current** Sets display mode to current.

- Launch PXE OpROM [Disabled]

Use the **Launch PXE OpROM** option to enable or disable boot option for legacy network devices.

- ➔ **Disabled** **DEFAULT** Ignore all PXE Option ROMs
- ➔ **Enabled** Load PXE Option ROMs.

- UEFI Boot [Disabled]

Use the **UEFI Boot** BIOS option to allow the system to boot from the UEFI devices.

- ➔ **Disabled** **DEFAULT** Disables to boot from the UEFI devices.
- ➔ **Enabled** Enables to boot from the UEFI devices.



## 5.6 Security

Use the **Security** menu (**BIOS Menu 22**) to set system and user passwords.

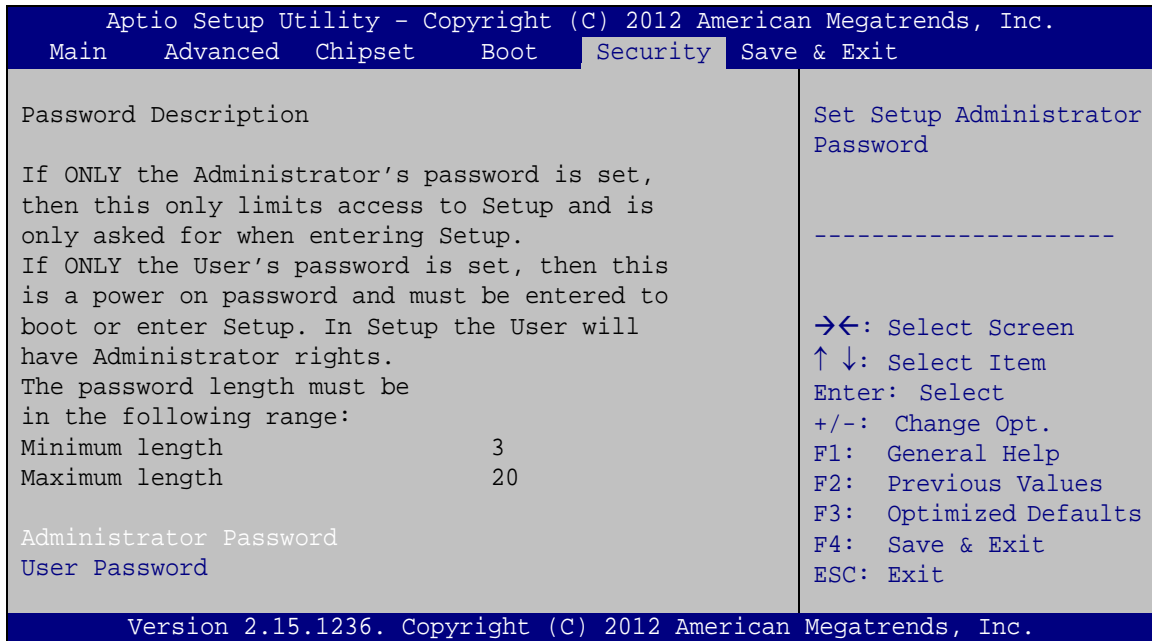

### BIOS Menu 22: Security

- Administrator Password

Use the **Administrator Password** to set or change an administrator password.

- User Password

Use the **User Password** to set or change a user password.

## 5.7 Save & Exit

Use the **Save & Exit** menu (**BIOS Menu 23**) to load default BIOS values, optimal failsafe values and to save configuration changes.

```

Aptio Setup Utility - Copyright (C) 2012 American Megatrends, Inc.
Main   Advanced  Chipset  Boot   Security  Save & Exit
-----
Save Changes and Exit
Discard Changes and Exit

Restore Defaults
Save as User Defaults
Restore User Defaults

Reset the system after
saving the changes.

-----
-><: Select Screen
↑↓: Select Item
Enter: Select
+/-: Change Opt.
F1:  General Help
F2:  Previous Values
F3:  Optimized Defaults
F4:  Save & Exit
ESC: Exit

Version 2.15.1236. Copyright (C) 2012 American Megatrends, Inc.

```

### BIOS Menu 23: Save & Exit

- Save Changes and Exit

Use the **Save Changes and Reset** option to save the changes made to the BIOS options and exit the system.

- Discard Changes and Exit

Use the **Discard Changes and Reset** option to exit the system without saving the changes made to the BIOS configuration setup program.

- Restore Defaults

Use the **Restore Defaults** option to load the optimal default values for each of the parameters on the Setup menus. **F3 key can be used for this operation.**

- Save as User Defaults

Use the **Save as User Defaults** option to save the changes done so far as user defaults.

- Restore User Defaults

Use the Restore User Defaults option to restore the user defaults to all the setup options.

Appendix

A

# Safety Precautions

---

## A.1 Safety Precautions

---



### WARNING:

The precautions outlined in this appendix should be strictly followed. Failure to follow these precautions may result in permanent damage to the TANK-760.

---

Please follow the safety precautions outlined in the sections that follow:

### A.1.1 General Safety Precautions

Please ensure the following safety precautions are adhered to at all times.

- ***Make sure the power is turned off and the power cord is disconnected*** when moving, installing or modifying the system.
- ***Do not apply voltage levels that exceed the specified voltage range.*** Doing so may cause fire and/or an electrical shock.
- ***Electric shocks can occur*** if opened while still powered on.
- ***Do not drop or insert any objects*** into the ventilation openings.
- ***If considerable amounts of dust, water, or fluids enter the system***, turn off the power supply immediately, unplug the power cord, and contact the system vendor.
- **DO NOT:**
  - Drop the system against a hard surface.
  - In a site where the ambient temperature exceeds the rated temperature

### A.1.2 Anti-static Precautions

---



### WARNING:

Failure to take ESD precautions during the installation of the TANK-760 may result in permanent damage to the TANK-760 and severe injury to the user.

---

## TANK-760 Embedded System

Electrostatic discharge (ESD) can cause serious damage to electronic components, including the TANK-760. Dry climates are especially susceptible to ESD. It is therefore critical that whenever the TANK-760 is opened and any of the electrical components are handled, the following anti-static precautions are strictly adhered to.

- **Wear an anti-static wristband:** Wearing a simple anti-static wristband can help to prevent ESD from damaging any electrical component.
- **Self-grounding:** Before handling any electrical component, touch any grounded conducting material. During the time the electrical component is handled, frequently touch any conducting materials that are connected to the ground.
- **Use an anti-static pad:** When configuring or working with an electrical component, place it on an anti-static pad. This reduces the possibility of ESD damage.
- **Only handle the edges of the electrical component:** When handling the electrical component, hold the electrical component by its edges.

### A.1.3 Product Disposal



#### CAUTION:

Risk of explosion if battery is replaced by an incorrect type. Only certified engineers should replace the on-board battery.

Dispose of used batteries according to instructions and local regulations.

- 
- Outside the European Union - If you wish to dispose of used electrical and electronic products outside the European Union, please contact your local authority so as to comply with the correct disposal method.
  - Within the European Union:

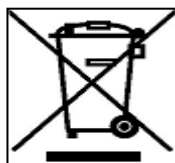

EU-wide legislation, as implemented in each Member State, requires that waste electrical and electronic products carrying the mark (left) must be disposed of separately from normal household waste. This includes

monitors and electrical accessories, such as signal cables or power cords. When you need to dispose of your display products, please follow the guidance of your local authority, or ask the shop where you purchased the product. The mark on electrical and electronic products only applies to the current European Union Member States.

Please follow the national guidelines for electrical and electronic product disposal.

## A.2 Maintenance and Cleaning Precautions

When maintaining or cleaning the TANK-760, please follow the guidelines below.

### A.2.1 Maintenance and Cleaning

Prior to cleaning any part or component of the TANK-760, please read the details below.

- The interior of the TANK-760 does not require cleaning. Keep fluids away from the TANK-760 interior.
- Be cautious of all small removable components when vacuuming the TANK-760.
- Turn the TANK-760 off before cleaning the TANK-760.
- Never drop any objects or liquids through the openings of the TANK-760.
- Be cautious of any possible allergic reactions to solvents or chemicals used when cleaning the TANK-760.
- Avoid eating, drinking and smoking within vicinity of the TANK-760.

### A.2.2 Cleaning Tools

Some components in the TANK-760 may only be cleaned using a product specifically designed for the purpose. In such case, the product will be explicitly mentioned in the cleaning tips. Below is a list of items to use when cleaning the TANK-760.

- **Cloth** – Although paper towels or tissues can be used, a soft, clean piece of cloth is recommended when cleaning the TANK-760.
- **Water or rubbing alcohol** – A cloth moistened with water or rubbing alcohol can be used to clean the TANK-760.
- **Using solvents** – The use of solvents is not recommended when cleaning the TANK-760 as they may damage the plastic parts.

## TANK-760 Embedded System

- **Vacuum cleaner** – Using a vacuum specifically designed for computers is one of the best methods of cleaning the TANK-760. Dust and dirt can restrict the airflow in the TANK-760 and cause its circuitry to corrode.
- **Cotton swabs** - Cotton swabs moistened with rubbing alcohol or water are excellent tools for wiping hard to reach areas.
- **Foam swabs** - Whenever possible, it is best to use lint free swabs such as foam swabs for cleaning.

Appendix

**B**

# Hazardous Materials Disclosure

---



## B.1 Hazardous Materials Disclosure Table for IPB Products Certified as RoHS Compliant Under 2002/95/EC Without Mercury

The details provided in this appendix are to ensure that the product is compliant with the Peoples Republic of China (China) RoHS standards. The table below acknowledges the presences of small quantities of certain materials in the product, and is applicable to China RoHS only.

A label will be placed on each product to indicate the estimated “Environmentally Friendly Use Period” (EFUP). This is an estimate of the number of years that these substances would “not leak out or undergo abrupt change.” This product may contain replaceable sub-assemblies/components which have a shorter EFUP such as batteries and lamps. These components will be separately marked.

Please refer to the table on the next page.

Part Name	Toxic or Hazardous Substances and Elements					
	Lead (Pb)	Mercury (Hg)	Cadmium (Cd)	Hexavalent Chromium (CR(VI))	Polybrominated Biphenyls (PBB)	Polybrominated Diphenyl Ethers (PBDE)
Housing	O	O	O	O	O	O
Display	O	O	O	O	O	O
Printed Circuit Board	O	O	O	O	O	O
Metal Fasteners	O	O	O	O	O	O
Cable Assembly	O	O	O	O	O	O
Fan Assembly	O	O	O	O	O	O
Power Supply Assemblies	O	O	O	O	O	O
Battery	O	O	O	O	O	O

O: This toxic or hazardous substance is contained in all of the homogeneous materials for the part is below the limit requirement in SJ/T11363-2006

X: This toxic or hazardous substance is contained in at least one of the homogeneous materials for this part is above the limit requirement in SJ/T11363-2006

## TANK-760 Embedded System

此附件旨在确保本产品符合中国 RoHS 标准。以下表格标示此产品中某有毒物质的含量符合中国 RoHS 标准规定的限量要求。

本产品上会附有“环境友好使用期限”的标签，此期限是估算这些物质“不会有泄漏或突变”的年限。本产品可能包含有较短的环境友好使用期限的可替换元件，像是电池或灯管，这些元件将会单独标示出来。

部件名称	有毒有害物质或元素					
	铅 (Pb)	汞 (Hg)	镉 (Cd)	六价铬 (CR(VI))	多溴联苯 (PBB)	多溴二苯 醚 (PBDE)
壳体	O	O	O	O	O	O
显示	O	O	O	O	O	O
印刷电路板	O	O	O	O	O	O
金属螺帽	O	O	O	O	O	O
电缆组装	O	O	O	O	O	O
风扇组装	O	O	O	O	O	O
电力供应组装	O	O	O	O	O	O
电池	O	O	O	O	O	O

O: 表示该有毒有害物质在该部件所有物质材料中的含量均在 SJ/T11363-2006 标准规定的限量要求以下。  
X: 表示该有毒有害物质至少在该部件的某一均质材料中的含量超出 SJ/T11363-2006 标准规定的限量要求。