



MODEL:
PPC-5152-D525

**Flat-bezel Panel PC with Touch Screen and Intel® Atom™ CPU,
USB 3.0, Dual Combo (SFP Fiber/RJ-45) Gigabit LAN, Audio,
RS-232/422/485, RoHS Compliant, IP 64 Protection**

User Manual

Revision

Date	Version	Changes
August 7, 2014	1.11	Minor changes
November 13, 2013	1.10	Updated for R11 version
July 4, 2012	1.02	Modified Table 3-4: RS-232/422/485 Serial Port Pinouts Added caution messages regarding the expansion card dimensions in Section 3.8 and Section 3.9
December 8, 2011	1.01	Update Table 1-3: System Specifications Updated Section 2.2: Packing List Updated Section 3.10: Mounting the System
September 23, 2011	1.00	Initial release

Copyright

COPYRIGHT NOTICE

The information in this document is subject to change without prior notice in order to improve reliability, design and function and does not represent a commitment on the part of the manufacturer.

In no event will the manufacturer be liable for direct, indirect, special, incidental, or consequential damages arising out of the use or inability to use the product or documentation, even if advised of the possibility of such damages.

This document contains proprietary information protected by copyright. All rights are reserved. No part of this manual may be reproduced by any mechanical, electronic, or other means in any form without prior written permission of the manufacturer.

TRADEMARKS

All registered trademarks and product names mentioned herein are used for identification purposes only and may be trademarks and/or registered trademarks of their respective owners.

WARNING

This device complies with Part 15 of the FCC Rules. Operation is subject to the following two conditions:

(1) this device may not cause harmful interference, and(2) this device must accept any interference received, including interference that may cause undesired operation.

NOTE: This equipment has been tested and found to comply with the limits for a Class B digital device, pursuant to part 15 of the FCC Rules. These limits are designed to provide reasonable protection against harmful interference in a residential installation. This equipment generates, uses and can radiate radio frequency energy and, if not installed and used in accordance with the instructions, may cause harmful interference to radio communications.

However, there is no guarantee that interference will not occur in a particular installation. If this equipment does cause harmful interference to radio or television reception, which can be determined by turning the equipment off and on, the user is encouraged to try to correct the interference by one or more of the following measures:

- Reorient or relocate the receiving antenna.
- Increase the separation between the equipment and receiver.
- Connect the equipment into an outlet on a circuit different from that to which the receiver is connected.
- Consult the dealer or an experienced radio/ TV technician for help.

You are cautioned that any change or modifications to the equipment not expressly approve by the party responsible for compliance could void your authority to operate such equipment.

IMPORTANT NOTE:

FCC Radiation Exposure Statement:

This equipment complies with FCC radiation exposure limits set forth for an uncontrolled environment. This equipment should be installed and operated with minimum distance 20cm between the radiator & your body.

Table of Contents

1 INTRODUCTION.....	1
1.1 OVERVIEW.....	2
1.2 MODEL VARIATIONS	3
1.3 FEATURES.....	3
1.4 EXTERNAL OVERVIEW.....	4
1.4.1 <i>Front Panel</i>	4
1.4.1.1 LED Indicators.....	5
1.4.2 <i>Bottom Panel</i>	6
1.4.3 <i>Side Panels</i>	8
1.4.4 <i>Top Panel</i>	9
1.4.5 <i>Rear Panel</i>	9
1.5 BACKPLANE OPTIONS	10
1.6 DIMENSIONS.....	11
1.7 SPECIFICATIONS	12
2 UNPACKING	15
2.1 UNPACKING.....	16
2.2 PACKING LIST.....	17
3 INSTALLATION	19
3.1 ANTI-STATIC PRECAUTIONS	20
3.2 INSTALLATION PRECAUTIONS	20
3.3 PREINSTALLED COMPONENTS.....	21
3.4 COMPACTFLASH® INSTALLATION	21
3.5 USB DEVICES INSTALLATION (INTERNAL)	22
3.6 SFP OPTICAL MODULE INSTALLATION (OPTIONAL)	24
3.7 HDD INSTALLATION.....	25
3.8 PCI EXPANSION CARD INSTALLATION	28
3.9 PCIe EXPANSION CARD INSTALLATION (OPTIONAL)	30
3.10 MOUNTING THE SYSTEM	32

3.10.1 Arm Mounting	32
3.10.2 Panel Mounting.....	34
3.10.3 Rack/Cabinet Mounting	36
3.10.4 Stand Mounting	38
3.10.5 Wall Mounting.....	39
3.11 BOTTOM PANEL CONNECTORS.....	42
3.11.1 Audio Connectors	42
3.11.2 LAN Connector.....	43
3.11.3 Power Input, 2-pin Terminal Block	44
3.11.4 Power Input, DIN Connector	45
3.11.5 RS-232 Serial Port (COM1, COM2).....	46
3.11.6 RS-232/422/485 Serial Port (COM3).....	47
3.11.6.1 COM3 Mode Select Switch	48
3.11.7 RJ-45 RS-422/485 Serial Port (COM4, COM5)	49
3.11.8 SFP Fiber Connectors.....	51
3.11.9 USB 2.0 Connectors	51
3.11.10 USB 3.0 Connectors	52
3.11.11 VGA Connector.....	53
3.12 POWER-UP THE SYSTEM.....	55
3.12.1 AT/ATX Power Mode Selection.....	55
3.12.2 Powering On/Off in ATX Power Mode	56
3.13 REMOTE CONTROL	56
4 SYSTEM MAINTENANCE	57
4.1 SYSTEM MAINTENANCE INTRODUCTION	58
4.2 ANTI-STATIC PRECAUTIONS	58
4.3 TURN OFF THE POWER	59
4.4 OPENING THE SYSTEM.....	59
4.5 REPLACING COMPONENTS.....	60
4.5.1 Memory Module Replacement	60
4.5.2 WLAN Card Replacement	61
5 AMI BIOS SETUP	65
5.1 INTRODUCTION.....	66
5.1.1 Starting Setup.....	66

PPC-5152-D525 Flat-bezel Panel PC

5.1.2	Using Setup	66
5.1.3	Getting Help.....	67
5.1.4	BIOS Menu Bar.....	67
5.2	MAIN.....	68
5.3	ADVANCED.....	69
5.3.1	ACPI Settings.....	69
5.3.2	CPU Configuration.....	71
5.3.3	IDE Configuration.....	72
5.3.4	USB Configuration.....	73
5.3.5	Super IO Configuration	75
5.3.5.1	Serial Port n Configuration	75
5.3.6	H/W Monitor	81
5.3.7	Serial Port Console Redirection	82
5.3.7.1	Console Redirection Settings.....	83
5.3.8	IEI Feature.....	85
5.4	CHIPSET	85
5.4.1	Host Bridge Configuration	86
5.4.2	South Bridge Configuration.....	87
5.4.3	Intel IGD SWSCI OpRegion.....	89
5.5	BOOT.....	91
5.6	SAVE & EXIT	92
6	SOFTWARE DRIVERS	94
6.1	AVAILABLE SOFTWARE DRIVERS	95
6.2	STARTING THE DRIVER PROGRAM	95
6.3	CHIPSET DRIVER INSTALLATION.....	95
6.4	GRAPHICS DRIVER INSTALLATION.....	99
6.5	LAN DRIVER INSTALLATION	103
6.6	AUDIO DRIVER INSTALLATION	106
6.7	TOUCH SCREEN DRIVER INSTALLATION	108
6.7.1	Calibrating the Touch Screen.....	111
6.8	USB 3.0 DRIVER INSTALLATION	113
A	BIOS CONFIGURATION OPTIONS.....	116
A.1	BIOS CONFIGURATION OPTIONS	117

B SAFETY PRECAUTIONS	119
B.1 SAFETY PRECAUTIONS.....	120
<i>B.1.1 General Safety Precautions</i>	<i>120</i>
<i>B.1.2 Anti-static Precautions</i>	<i>121</i>
<i>B.1.3 Product Disposal</i>	<i>121</i>
B.2 MAINTENANCE AND CLEANING PRECAUTIONS	122
<i>B.2.1 Maintenance and Cleaning.....</i>	<i>122</i>
<i>B.2.2 Cleaning Tools.....</i>	<i>123</i>
C WATCHDOG TIMER	124
D HAZARDOUS MATERIALS DISCLOSURE	127
D.1 HAZARDOUS MATERIAL DISCLOSURE TABLE FOR IPB PRODUCTS CERTIFIED AS ROHS COMPLIANT UNDER 2002/95/EC WITHOUT MERCURY	128

List of Figures

Figure 1-1: PPC-5152-D525 Panel PC	2
Figure 1-2: Front View	5
Figure 1-3: LED Indicators	5
Figure 1-4: Bottom View	7
Figure 1-5: Side View.....	8
Figure 1-6: Top View.....	9
Figure 1-7: Rear View	9
Figure 1-8: Backplane Option 1 (HPE-2S1)	10
Figure 1-9: Backplane Option 2 (HPE-2S2)	10
Figure 1-10: PPC-5152-D525 Dimensions (mm)	11
Figure 3-1: CompactFlash® Cover Plate	21
Figure 3-2: CompactFlash® Slot	22
Figure 3-3: Remove the Internal USB Port Access Panel.....	23
Figure 3-4: Internal USB Port Location	23
Figure 3-5: SFP Optical Module	24
Figure 3-6: SFP Module Installation.....	24
Figure 3-7: Rear Panel Retention Screws	25
Figure 3-8: HDD Bracket Retention Screws.....	26
Figure 3-9: HDD Installation	26
Figure 3-10: HDD Bracket Installation	27
Figure 3-11: Expansion Slot Retention Screw	29
Figure 3-12: Install PCI Card.....	29
Figure 3-13: Expansion Slot Retention Screw	31
Figure 3-14: Install PCIe Card.....	31
Figure 3-15: VESA Compliant Arm.....	32
Figure 3-16: Arm Mounting Retention Screw Holes.....	33
Figure 3-17: Suggested Panel Cut Out Size for PPC-5152-D525 (Unit: mm)	34
Figure 3-18: Panel Mounting Clamp Slots (Side View)	35
Figure 3-19: Tighten the Panel Mounting Clamp Screws	36
Figure 3-20: The Rack/Cabinet Bracket.....	37
Figure 3-21: Secure the Rack/Cabinet Bracket.....	37

Figure 3-22: Install into a Rack/Cabinet	38
Figure 3-23: VESA Compliant Stand.....	38
Figure 3-24: Stand Mounting Retention Screw Holes.....	39
Figure 3-25: Wall-mounting Bracket.....	40
Figure 3-26: Chassis Support Screws.....	41
Figure 3-27: Secure the Panel PC	42
Figure 3-28: RJ-45 Ethernet Connector.....	43
Figure 3-29: LAN Connection	44
Figure 3-30: 2-pin Terminal Block Pinouts	45
Figure 3-31: Power Input Terminal Block Installation.....	45
Figure 3-32: RS-232 Serial Port	46
Figure 3-33: RS-232/422/485 Serial Port.....	47
Figure 3-34: Serial Device Connector.....	48
Figure 3-35: COM3 RS-232/422/485 Serial Port Select Switch Location.....	49
Figure 3-36: RJ-45 RS-422/485 Serial Port	49
Figure 3-37: RJ-45 RS-422/485 Serial Device Connection.....	50
Figure 3-38: RS-422/485 Serial Port (DB-9).....	51
Figure 3-39: USB Device Connection	53
Figure 3-40: VGA Connector	54
Figure 3-41: VGA Connector	55
Figure 3-42: AT/ATX Power Mode Switch	55
Figure 3-43: Power Button.....	56
Figure 3-44: Remote Control	56
Figure 4-1: Back Cover Retention Screws	60
Figure 4-2: DDR SO-DIMM Module Installation.....	61
Figure4-3: Removing the Antennas.....	62
Figure4-4: Releasing the WLAN Card.....	62
Figure4-5: Removing the WLAN card.....	63
Figure4-6: Attaching the Antennas.....	64
Figure 6-1: Chipset Driver Screen.....	96
Figure 6-2: Chipset Driver Welcome Screen.....	97
Figure 6-3: Chipset Driver License Agreement	97
Figure 6-4: Chipset Driver Read Me File	98
Figure 6-5: Chipset Driver Setup Operations	98
Figure 6-6: Chipset Driver Installation Finish Screen.....	99

PPC-5152-D525 Flat-bezel Panel PC

Figure 6-7: Graphics Driver Read Me File	100
Figure 6-8: Graphics Driver Setup Files Extracted	100
Figure 6-9: Graphics Driver Welcome Screen	101
Figure 6-10: Graphics Driver License Agreement.....	101
Figure 6-11: Graphics Driver Read Me File	102
Figure 6-12: Graphics Driver Setup Operations	102
Figure 6-13: Graphics Driver Installation Finish Screen	103
Figure 6-14: LAN Driver Welcome Screen	104
Figure 6-15: LAN Driver Welcome Screen	104
Figure 6-16: LAN Driver Installation	105
Figure 6-17: LAN Driver Installation Complete.....	105
Figure 6-18: Audio Driver Welcome Screen.....	106
Figure 6-19: Audio Driver Installation.....	107
Figure 6-20: AC'97 Driver Installation Complete	107
Figure 6-21: Touch Screen Driver Welcome Screen	108
Figure 6-22: Touch Screen Driver License Agreement.....	109
Figure 6-23: Touch Screen Driver Choose Install Location	109
Figure 6-24: Touch Screen Driver Installation Screen.....	110
Figure 6-25: Touch Screen Driver Update Complete	110
Figure 6-26: PenMount Monitor Icon	111
Figure 6-27: PenMount Monitor Popup Menu.....	111
Figure 6-28: Configuration Screen.....	112
Figure 6-29: Calibration Initiation Screen	112
Figure 6-30: Calibration Screen	113
Figure 6-31: USB 3.0 Driver Welcome Screen	114
Figure 6-32: USB 3.0 Driver License Agreement.....	114
Figure 6-33: USB 3.0 Driver Installation Screen	115
Figure 6-34: USB 3.0 Driver Update Complete	115

List of Tables

Table 1-1: Model Variations	3
Table 1-2: LED Indicators	6
Table 1-3: System Specifications.....	14
Table 3-1: LAN Pinouts	43
Table 3-2: RJ-45 Ethernet Connector LEDs	43
Table 3-3: RS-232 Serial Port Pinouts	46
Table 3-4: RS-232/422/485 Serial Port Pinouts	47
Table 3-5: COM3 RS-232/422/485 Serial Port Select Settings	48
Table 3-6: RJ-45 RS-422/485 Serial Port Pinouts	50
Table 3-7: RS-422/485 Serial Port Pinouts	51
Table 3-8: USB 2.0 Port Pinouts.....	52
Table 3-9: USB 3.0 Port Pinouts.....	52
Table 3-10: VGA Connector Pinouts.....	54
Table 5-1: BIOS Navigation Keys	67

Chapter

1

Introduction

1.1 Overview



Figure 1-1: PPC-5152-D525 Panel PC

The fanless PPC-5152-D525 is Intel® Atom™ D525 powered flat-bezel panel PC with a rich variety of functions and peripherals. The PPC-5152-D525 panel PC is designed for easy and simplified integration in to various applications.

An Intel® ICH8M chipset ensures optimal memory, graphics, and peripheral I/O support. The system comes with 1GB of preinstalled DDR3 SDRAM ensuring smooth data throughputs with reduced bottlenecks and fast system access.

Five serial ports and six USB ports ensure simplified connectivity to a variety of external peripheral devices. A VGA connector enables connectivity to other monitors. Wi-Fi capabilities and the dual combo (SFP Fiber/RJ-45) gigabit LAN connectors ensure smooth connection of the system to an external LAN.

PPC-5152-D525 Falt-bezel Panel PC

1.2 Model Variations

The model numbers and model variations are listed below.

Model	CPU	Expansion Slots
PPC-5152-D525/R/1G/2P-R11	Intel® Atom™ D525	Two PCI slots
PPC-5152-D525/R/1G/1P1E-R11	Intel® Atom™ D525	One PCI slot and one PCIe x1 slot

Table 1-1: Model Variations

1.3 Features

All the PPC-5152-D525 models feature the following:

- 15" 400nits 1024 x 768 LCD with LED backlight
- 5-wire resistive type touch screen
- Fanless system with 1.8GHz Intel® Atom™ D525 dual-core processor
- Dual combo gigabit Ethernet ports (10/100/1000 Base-T(X) or 1000 Base SFP)
- Built-in 2-megapixel webcam with AE and AWB capabilities
- Flexible expansion interfaces:
 - Two PCI slots or
 - One PCI slot and one PCIe x1 slot
- Six USB ports:
 - 2 x USB 2.0 (I/O panel)
 - 2 x USB 3.0 (I/O panel)
 - 1 x USB 2.0 (front panel)
 - 1 x USB 2.0 (internal)
- Five serial ports:
 - 2 x RS-232 (DB-9)
 - 2 x RS-422/485 (RJ-45)
 - 1 x RS-232/422/485 (DB-9)
- Optional Wi-Fi 802.11b/g/n connection
- IP 64 compliant system
- AT or ATX power mode
- RoHS compliance

1.4 External Overview

The flat panel PC is a rectangular cubic structure that comprises of a screen, rear panel, top panel, bottom panel and two side panels (left and right). An aluminum frame surrounds the front screen. The rear panel provides screw holes for a wall-mounting bracket, and an arm mounting interface. The bottom panel provides access to external interface connectors.

1.4.1 Front Panel

The front side of the PPC-5152-D525 is a flat panel TFT LCD screen surrounded by an aluminum frame. At the top of the front panel features one 2-megapixel webcam that supports auto-exposure (AE) and auto white balance (AWB). The front panel also has following connector, LED indicators and sensors:

- One USB 2.0 port
- LEDs
 - Power LED
 - AT/ATX power mode LEDs
 - Wi-Fi connection LED
 - HDD activity LED
 - CPU temperature alert LED
 - LAN connection LEDs
 - SFP connection LEDs
- Sensors
 - Infrared remote control sensor
 - Ambient light sensor

PPC-5152-D525 Falt-bezel Panel PC



Figure 1-2: Front View

1.4.1.1 LED Indicators

The LED indicators on the front panel of the PPC-5152-D525 are shown below.

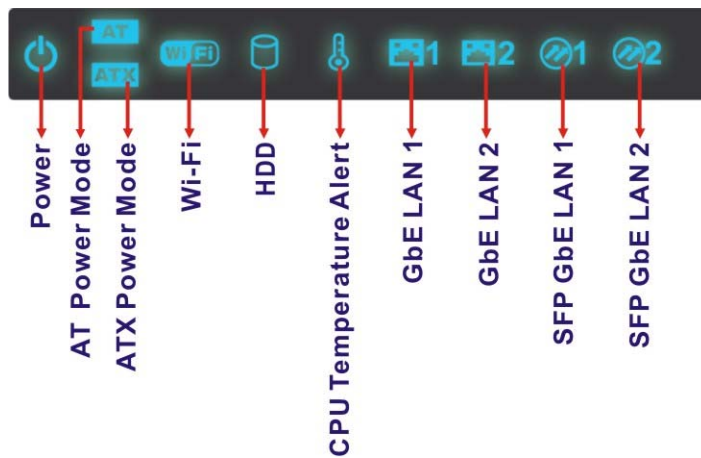

Figure 1-3: LED Indicators

The descriptions of each LED indicator are listed below.

LED Indicator	Description
Power	Power on.
AT/ATX Power Mode	Shows the power mode status. Controlled by the AT/ATX power mode switch on the bottom panel.
Wi-Fi	The Wi-Fi module is enabled or disabled. Controlled by the BIOS (see Section 5.4.2).
HDD	Shows the HDD activity.
CPU Temperature Alert	Blue: the CPU temperature is normal. Red: the CPU temperature is too high.
LAN 1	The LAN 1 port is linked.
LAN 2	The LAN 2 port is linked.
SFP 1	The SFP 1 port is linked.
SFP 2	The SFP 2 port is linked.

Table 1-2: LED Indicators



NOTE:

If the CPU temperature alert LED shows in red, the user must lower the environment temperature or close some running applications to cool down the CPU.

1.4.2 Bottom Panel

The following is a list of the bottom panel peripheral device connectors on the PPC-5152-D525.

- 1 x 9 V ~ 36 V DC power input terminal block
- 1 x 9 V ~ 36 V DC power input connector
- 2 x Audio jacks
- 1 x CAN but connector
- 2 x RJ-45 GbE connector
- 2 x SFP Fiber Gigabit LAN connectors

PPC-5152-D525 Falt-bezel Panel PC

- 2 x RS-232 serial port connector (COM1, COM2)
- 1 x RS-232/422/485 serial port (COM3) connector
- 2 x RS-422/485 COM ports by RJ-45 connectors (COM4, COM5)
- 2 x USB 2.0 connectors
- 2 x USB 3.0 connectors
- 1 x VGA connector
- 1 x CF Type II slot
- 2 x Expansion slots for PCI/PCIe expansion modules

The bottom panel also includes the following switches and buttons:

- 1 x Power switch
- 1 x AT/ATX power mode switch
- 1 x Reset button

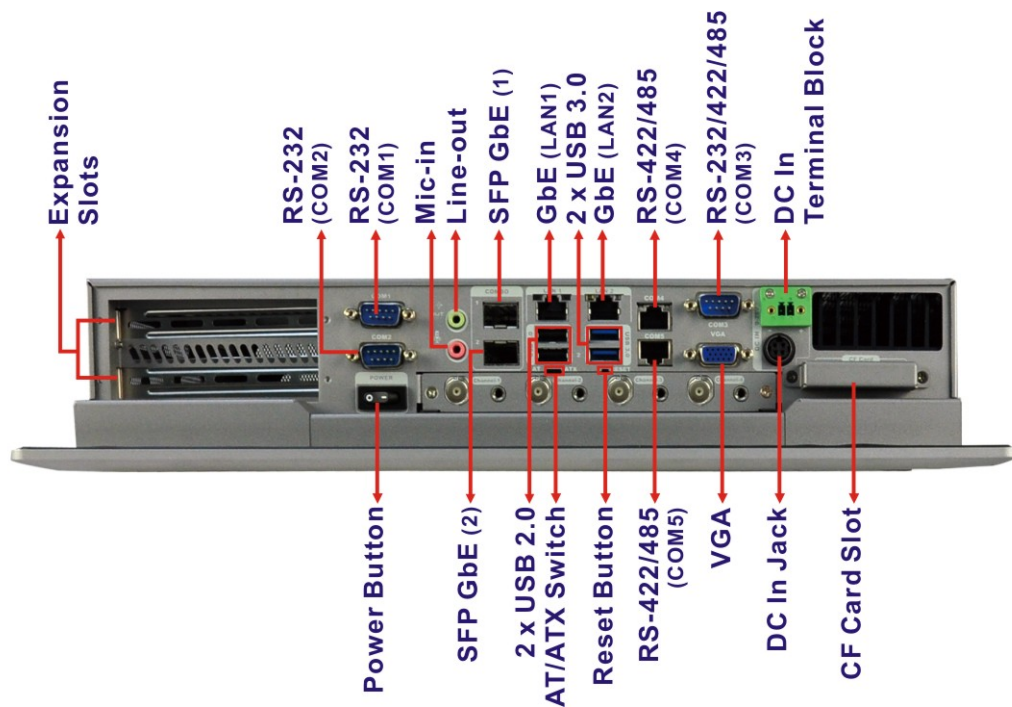

Figure 1-4: Bottom View

**NOTE:**

The PPC-5152-D525 provides two pairs of combo LANs, one is SFP fiber and the other is GbE. For each pair of combo LAN, only one LAN port can work at one time, and the SFP Fiber port works prior to the RJ-45 one. When a LAN port is linked, the corresponding LED indicator lights up. Refer to **Section 1.4.1.1** for the locations of the LED indicators.

1.4.3 Side Panels

Both side panels of the flat panel PC have some vents for ventilation and slots for installing the panel mounting clamps (**Figure 1-5**).

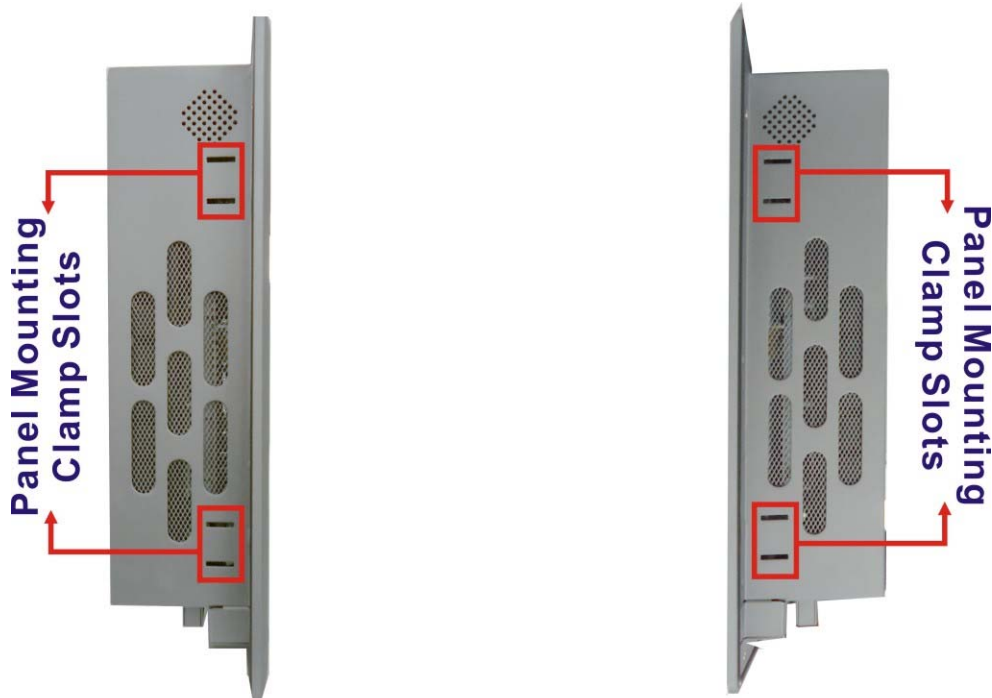

Figure 1-5: Side View

PPC-5152-D525 Falt-bezel Panel PC

1.4.4 Top Panel

The top panel of the flat panel PC have some vents for ventilation and slots for installing the panel mounting clamps. The model with wireless LAN module also includes two wireless LAN antenna connectors on the top panel (**Figure 1-5**).



Figure 1-6: Top View

1.4.5 Rear Panel

The rear panel has retention screw holes that support a wall-mounting bracket. The rear panel also provides access to the internal USB port.

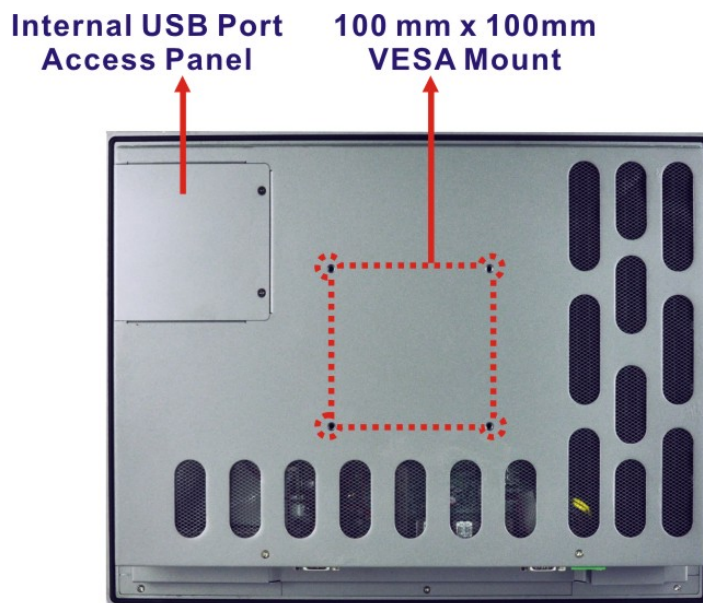

Figure 1-7: Rear View

1.5 Backplane Options

The backplane options of the PPC-5152-D525 are shown below.

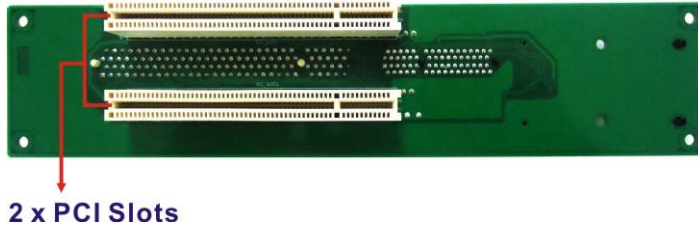

Figure 1-8: Backplane Option 1 (HPE-2S1)



Figure 1-9: Backplane Option 2 (HPE-2S2)

The rated voltage and current of the backplane are listed below:

Rated Voltage	Rated Current
+5 V	5 A
+12 V	2.4 A
-12 V	0.1 A
+3.3 V	8 A



WARNING:

The system default power is 90 W. The maximum total power of the backplane to support expansion cards is 35 W. The power of the selected expansion cards can not exceed the max. power (35 W), otherwise, the system may fail.

PPC-5152-D525 Falt-bezel Panel PC

1.6 Dimensions

The dimensions of the PPC-5152-D525 are shown in **Figure 1-10** and listed below.

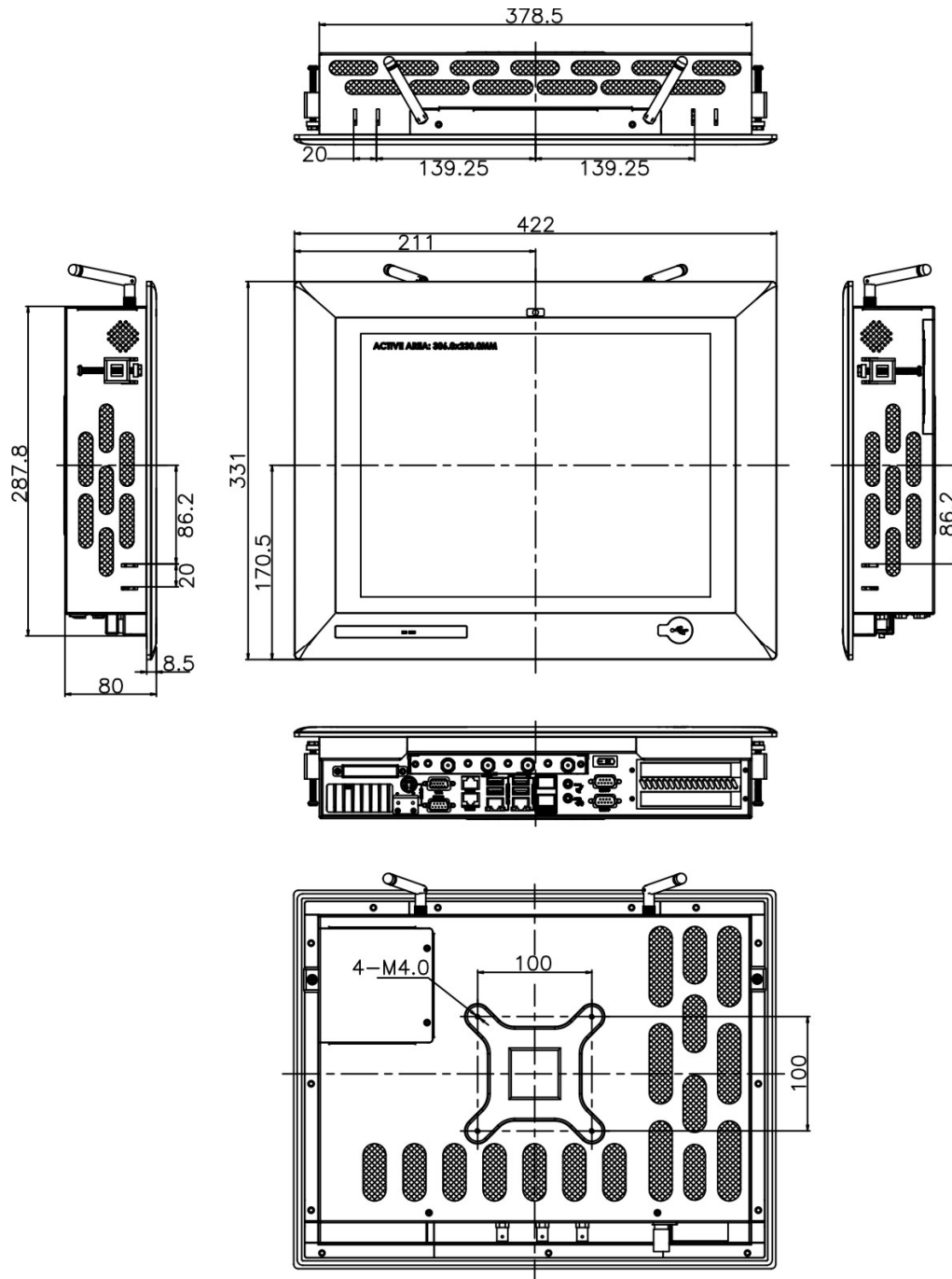

Figure 1-10: PPC-5152-D525 Dimensions (mm)

1.7 Specifications

The technical specifications for the PPC-5152-D525 system are listed in **Table 1-3**.

Specification	PPC-5152-D525
LCD Size	15"
Max. Resolution	1024 x 768 (XGA)
Brightness	400 cd/m ²
Contrast Ratio	500:1
LCD Color	16.2 M
Pixel Pitch (mm)	0.1095 (H) x 0.1095 (V)
Viewing Angle (H-V)	160 (H) / 140 (V)
Backlight MTBF	50,000 hours
SBC Model	PPCMB-5152A-D525
CPU	1.8 GHz Intel® Atom™ D525 dual-core processor
Chipsets	Intel® ICH8M
Memory	On-board 1.0 GB DDR3 SDRAM SO-DIMM (system max. 4 GB)
Ethernet	Realtek RTL8111E PCIe GbE controller supports ASF 2.0
Drive Bay	One 2.5" SATA HDD bay
CompactFlash®	One CF Type II socket
SSD	SATA slim SSD
Watchdog Timer	Software Programmable supports 1 sec. ~ 255 sec. system reset
Camera	2-megapixel webcam supports AE and AWB
Ethernet	Dual Combo (SFP Fiber/RJ-45) Gigabit LAN

PPC-5152-D525 Falt-bezel Panel PC

Wireless LAN	Optional 802.11b/g/n wireless module
Audio	2 x Audio speakers 1 x Line-out connector 1 x Mic-in connector
Expansion	Two PCI slots or One PCI slot and one PCIe x1 slot
Construction Material	Aluminum (front panel) Heavy-duty steel (chassis)
Mounting	Wall, Panel, Rack, Stand, Arm (VESA 100 mm x 100 mm)
Front Panel Color	PMS 8401C
Dimensions (W x H x D)	422 mm x 331 mm x 80 mm
Cut-out Dimensions (W x H)	390 mm x 290 mm
Weight (Net/Gross)	6.5kg/7.0kg
Operating Temperature	-20°C ~ 50°C
Storage Temperature	-30°C ~ 80°C
Relative Humidity	5%~90%, non-condensing
IP Level	IP 64 compliant front panel
Touch Screen	5-wire resistive type
Vibration	MIL-STD-810F 514.5C-2 (with CF card or SSD)
Shock	Half-sine wave shock 3G; 11ms; 3 shocks per axis
Power Adapter	90 W
	Input: 100 VAC ~ 240 VAC @ 50 Hz / 60 Hz
	Output: 19 VDC

Power Requirement	DC input: Terminal block: 9 V ~ 36 V DC jack: 9 V ~ 36 V
Power Consumption	50 W (without add-on card)
I/O Ports and Switches	1 x 9~36 V DC In terminal block <hr/> 1 x 9~36 V DC In jack <hr/> Five serial ports : 2 x DB-9 RS-232 ports 1 x DB-9 RS-232/422/485 port 2 x RJ-45 RS-422/485 ports <hr/> Six USB ports: 2 x USB 2.0 (I/O panel) 2 x USB 3.0 (I/O panel) 1 x USB 2.0 (front panel) 1 x USB 2.0 (internal) <hr/> 2 x Combo (SFP Fiber/RJ-45) Gigabit LAN <hr/> 2 x Audio jacks (Line-out, Mic-in) <hr/> 1 x VGA connector <hr/> 1 x AT/ATX power mode switch <hr/> 1 x Power switch <hr/> 1 x Reset button <hr/> Optional 4-channel video/audio capture connectors

Table 1-3: System Specifications

Chapter

2

Unpacking

2.1 Unpacking

To unpack the flat panel PC, follow the steps below:



WARNING!









The front side LCD screen has a protective plastic cover stuck to the screen. Only remove the plastic cover after the panel PC has been properly installed. This ensures the screen is protected during the installation process.







- Step 1:** Use box cutters, a knife or a sharp pair of scissors that seals the top side of the external (second) box.
- Step 2:** Open the external (second) box.
- Step 3:** Use box cutters, a knife or a sharp pair of scissors that seals the top side of the internal (first) box.
- Step 4:** Lift the monitor out of the boxes.
- Step 5:** Remove both polystyrene ends, one from each side.
- Step 6:** Pull the plastic cover off the panel PC.
- Step 7:** Make sure all the components listed in the packing list are present.

PPC-5152-D525 Falt-bezel Panel PC

2.2 Packing List

The PPC-5152-D525 panel PC is shipped with the following components:

Quantity	Item	Image
1	PPC-5152-D525 panel PC	
1	Power adapter (P/N: 63040-010090-020-RS)	
1	Power cord (P/N: 32702-000401-100-RS)	
2	RJ-45 to DB-9 COM port cable (P/N: 32005-000700-100-RS)	
1	Remote control (P/N: 7Z000-8T00320ICP05G-RS)	
1	Pluggable DC-in terminal block (P/N: 33101-000897-RS)	
4	HDD installation screws (M3*4) (P/N: 44043-030051-RS)	
4	VESA mount screws (M4*6) (P/N: 44033-040062-RS)	

4	Backup chassis screws (M3*4) (P/N: 44013-030041-RS)	
4	Backup capture card screws (M3*6) (P/N: 44003-030062-RS)	
6	Panel mounting clamps (P/N: 19Z00-000024-RS)	
1	Touch pen (P/N: 43125-0002C0-00-RS)	
1	User manual CD and driver CD (P/N: IEI-7B000-000732-RS)	
1	One Key Recover CD (P/N: IEI-7B000-000724-RS)	

If any of these items are missing or damaged, contact the distributor or sales representative immediately.

Chapter

3

Installation

3.1 Anti-static Precautions

**WARNING:**

Failure to take ESD precautions during the maintenance of the EP series may result in permanent damage to the EP series and severe injury to the user.

Electrostatic discharge (ESD) can cause serious damage to electronic components, including the PPC-5152-D525. Dry climates are especially susceptible to ESD. It is therefore critical that whenever the PPC-5152-D525 is accessed internally, or any other electrical component is handled, the following anti-static precautions are strictly adhered to.

- ***Wear an anti-static wristband:*** - Wearing a simple anti-static wristband can help to prevent ESD from damaging the board.
- ***Self-grounding:*** - Before handling the board touch any grounded conducting material. During the time the board is handled, frequently touch any conducting materials that are connected to the ground.
- ***Use an anti-static pad:*** - When configuring the PPC-5152-D525, place it on an antic-static pad. This reduces the possibility of ESD damaging the PPC-5152-D525.
- ***Only handle the edges of the PCB:*** - When handling the PCB, hold the PCB by the edges.

3.2 Installation Precautions

When installing the panel PC, please follow the precautions listed below:

- **Power turned off:** When installing the panel PC, make sure the power is off. Failing to turn off the power may cause severe injury to the body and/or damage to the system.
- **Certified Engineers:** Only certified engineers should install and modify onboard functionalities.
- **Anti-static Discharge:** If a user open the rear panel of the panel PC, to

PPC-5152-D525 Falt-bezel Panel PC

configure the jumpers or plug in added peripheral devices, ground themselves first and wear an anti-static wristband.

3.3 Preinstalled Components

The following components are all preinstalled.

- Motherboard
- TFT LCD screen
- DDR3 memory module
- Resistive type touch screen
- Stereo speakers
- Webcam
- PCI riser card

Preinstalled OEM customizations may include the following.

- Different DDR3 memory module
- Wireless module
- Video/audio capture card

3.4 CompactFlash® Installation

To install the CompactFlash® card, please follow the steps below:

- Step 1:** Undo the CompactFlash® slot cover screw and remove the CompactFlash® slot cover.



Figure 3-1: CompactFlash® Cover Plate

Step 2: Insert the CompactFlash® card into the slot.



Figure 3-2: CompactFlash® Slot

Step 3: Fasten the CompactFlash® cover plate.

3.5 USB Devices Installation (Internal)

The PPC-5152-D525 has one internal USB 2.0 port inside the chassis. This USB port is reserved for the USB encryption card, which provides software developers an intelligent software protection tool. The software and data protection can prevent intelligent property from being used illicitly.

To access the internal USB 2.0 port, follow the instructions below.

Step 1: Remove the internal USB port access panel by removing the two retention screws.

PPC-5152-D525 Falt-bezel Panel PC



Figure 3-3: Remove the Internal USB Port Access Panel

Step 2: Locate the internal USB port. See **Figure 3-4**.



Figure 3-4: Internal USB Port Location

Step 3: Install the USB dongle. Correctly align the USB dongle with the connector and insert the USB dongle into the connector.

Step 4: Reinstall the internal USB port access panel.

3.6 SFP Optical Module Installation (Optional)

The following SFP optical module can be purchased separately.



Figure 3-5: SFP Optical Module

To install the SFP optical module, please follow the steps below:

- Step 1:** Locate the SFP fiber connectors. The locations of the connectors are shown in **Figure 1-4**.
- Step 2:** Align the SFP module with one of the SFP fiber connectors on the PPC-5152-D525 (**Figure 3-6**).
- Step 3:** Once aligned, slide the SFP module into place (**Figure 3-6**).



Figure 3-6: SFP Module Installation

PPC-5152-D525 Falt-bezel Panel PC



NOTE:

The pin locations of the SFP connector 2 are opposite to the SFP connector 1. Please rotate the SFP module to a proper position to install the SFP module into the SFP connector 2.

3.7 HDD Installation

The PPC-5152-D525 has one internal HDD bay. To install the HDD, follow the instructions below.

Step 1: Remove a total of ten retention screws from the back cover, eight on the rear of the frame and two on the rear panel (**Figure 3-7**).

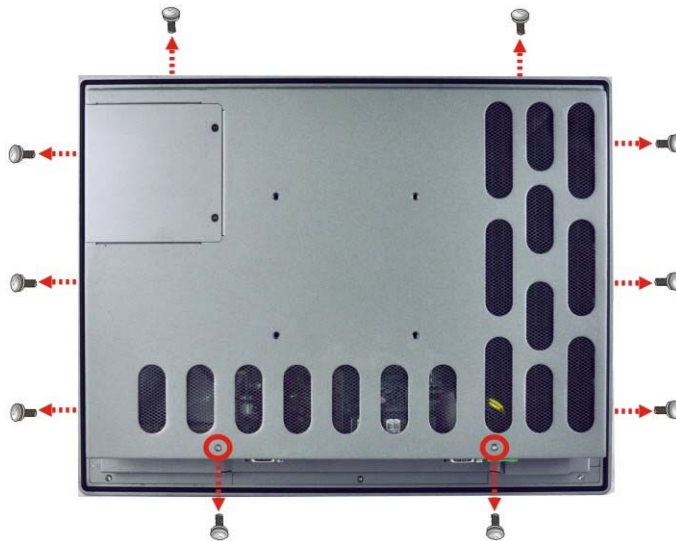

Figure 3-7: Rear Panel Retention Screws

Step 2: Remove the four HDD bracket retention screws and unplug the SATA cable and the SATA power cable from the motherboard. See **Figure 3-8**.

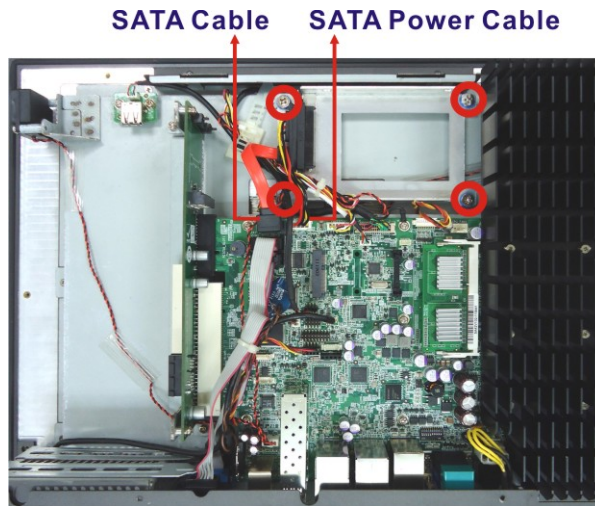

Figure 3-8: HDD Bracket Retention Screws

- Step 3:** Lift the HDD bracket out of the PPC-5152-D525.
- Step 4:** Remove the SATA connector from the bracket by removing the two retention screws on the bottom of the bracket.
- Step 5:** Connect the HDD to the SATA connector first, then place the HDD onto the bracket. Secure the SATA connector with the HDD bracket by two previously removed screws.
- Step 6:** Secure the HDD with the HDD bracket by four retention screws (**Figure 3-9**).

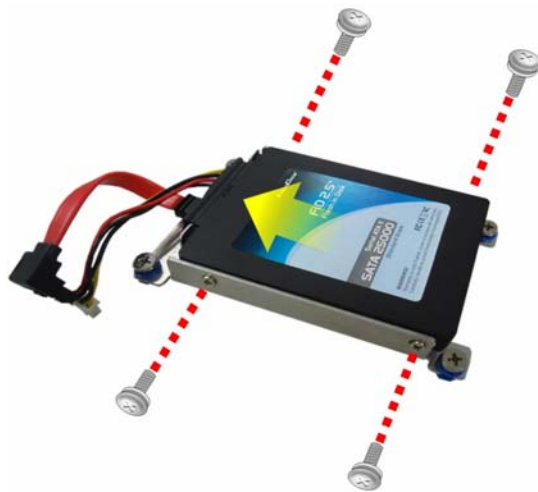

Figure 3-9: HDD Installation

PPC-5152-D525 Flat-bezel Panel PC

Step 7: Secure the HDD bracket with the PPC-5152-D525 by the four retention screws that were previously removed (**Figure 3-10**).



Figure 3-10: HDD Bracket Installation

Step 8: Connect the SATA cable and the SATA power cable to the corresponding connectors on the motherboard.

Step 9: Reinstall the rear panel to the PPC-5152-D525.

3.8 PCI Expansion Card Installation



CAUTION:

The maximum dimensions of the expansion card should be 200 mm in length, 100 mm in width and 20 mm in height. The width of the I/O panel should be no more than 73.8 mm. The diagram below shows the dimensions of the expansion slot on the bottom panel of the PPC-5152-D525.

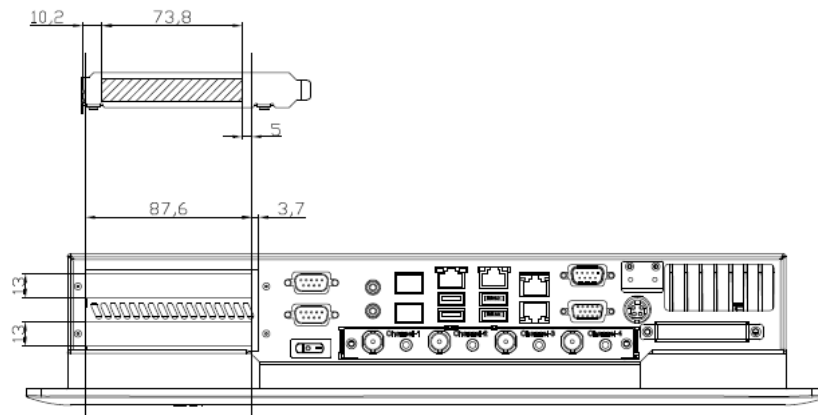

To install a PCI expansion card, please do the following.

Step 1: Remove the rear cover. See **Section 3.7 Step 1**.

Step 2: Remove the expansion slot cover. The expansion slot cover is secured to the system with a single retention screw. Remove the screw.

PPC-5152-D525 Fault-bezel Panel PC



Figure 3-11: Expansion Slot Retention Screw

Step 3: Insert the expansion card. Align the PCI expansion card edge connector with the PCI expansion slot on the PCI riser card. Gently insert the PCI card into the PCI expansion slot.

Step 4: Secure the expansion card. Once the PCI card is correctly installed in the system, reinsert the previously removed retention screw to secure the card to the I/O interface panel.

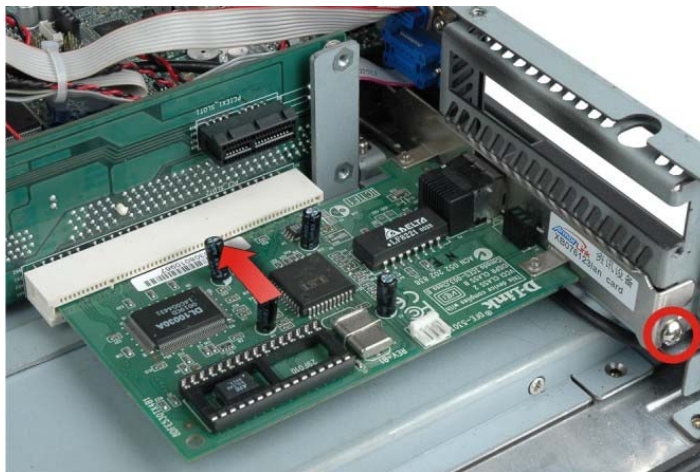

Figure 3-12: Install PCI Card

3.9 PCIe Expansion Card Installation (Optional)



CAUTION:

The maximum dimensions of the expansion card should be 200 mm in length, 100 mm in width and 20 mm in height. The width of the I/O panel should be no more than 73.8 mm. The diagram below shows the dimensions of the expansion slot on the bottom panel of the PPC-5152-D525.

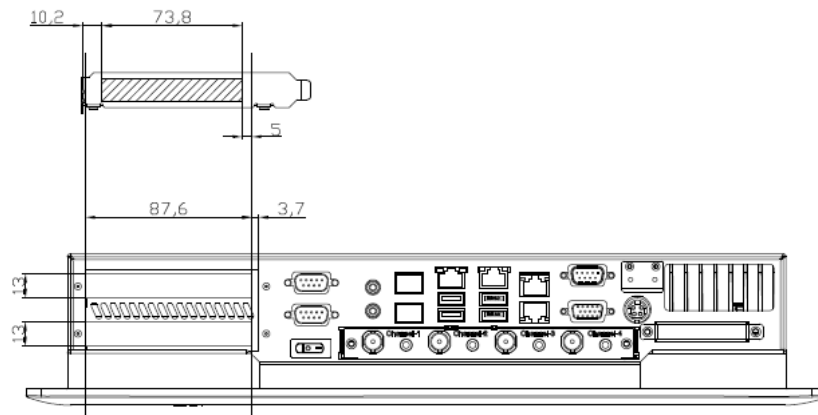

To install a PCIe expansion card, please do the following.

Step 1: Remove the rear cover. See **Section 3.7 Step 1**.

Step 2: Remove the expansion slot cover. The expansion slot cover is secured to the system with a single retention screw. Remove the screw.

PPC-5152-D525 Falt-bezel Panel PC

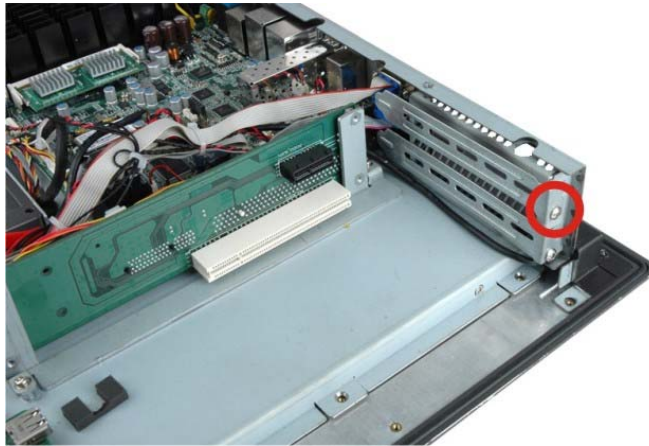

Figure 3-13: Expansion Slot Retention Screw

Step 3: Insert the expansion card. Align the PCIe expansion card edge connector with the PCIe expansion slot on the PCIe riser card. Gently insert the PCIe card into the PCIe expansion slot.

Step 4: Secure the expansion card. Once the PCIe card is correctly installed in the system, reinsert the previously removed retention screw to secure the card to the I/O interface panel.



Figure 3-14: Install PCIe Card

3.10 Mounting the System

**WARNING:**

When mounting the flat panel PC onto an arm or onto the wall, it is better to have more than one person to help with the installation to make sure the flat panel PC does not fall down and get damaged.

The following installation options are available:

- Arm mounting
- Panel mounting
- Rack/Cabinet mounting
- Stand mounting
- Wall mounting

The mounting methods are described below.

3.10.1 Arm Mounting

The PPC-5152-D525 can be installed on any arm that supports the standard VESA mounting interface. An example arm is shown below.



Figure 3-15: VESA Compliant Arm

To install the PPC-5152-D525 on the arm, follow the directions below.

PPC-5152-D525 Flat-bezel Panel PC

**NOTE:**

Make sure the arm supports standard VESA mounting. The PPC-5152-D525 uses a VESA mounting to attach to the arm.

- Step 1:** The arm is purchased separately. Follow the instructions in the arm's user manual to securely attach the arm to the wall.
- Step 2:** Once the mounting arm has been firmly attached to the surface, lift the panel PC onto the interface pad of the mounting arm.
- Step 3:** Align the retention screw holes on the mounting arm interface with those in the panel PC. The arm mount retention screw holes are shown in **Figure 3-16**.

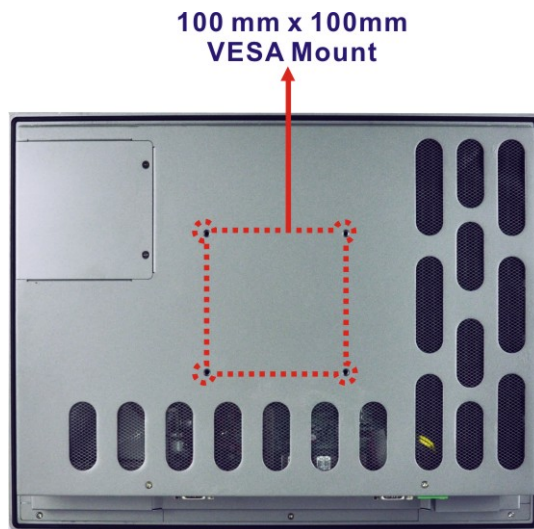

Figure 3-16: Arm Mounting Retention Screw Holes

- Step 4:** Secure the flat panel PC to the interface pad by inserting four retention screws through the bottom of the mounting arm interface pad and into the flat panel PC.

3.10.2 Panel Mounting

To mount the PPC-5152-D525 flat panel PC into a panel, please follow the steps below.

- Step 1:** Select the position in the panel to mount the panel PC.
- Step 2:** Cut out a section from the panel that corresponds to the dimensions of the flat panel PC chassis. The panel section that is cut out must be smaller than the size of the aluminum frame that surrounds the TFT LCD panel but just large enough for the chassis to fit through. Refer to **Figure 3-17** for the suggested cut out size.

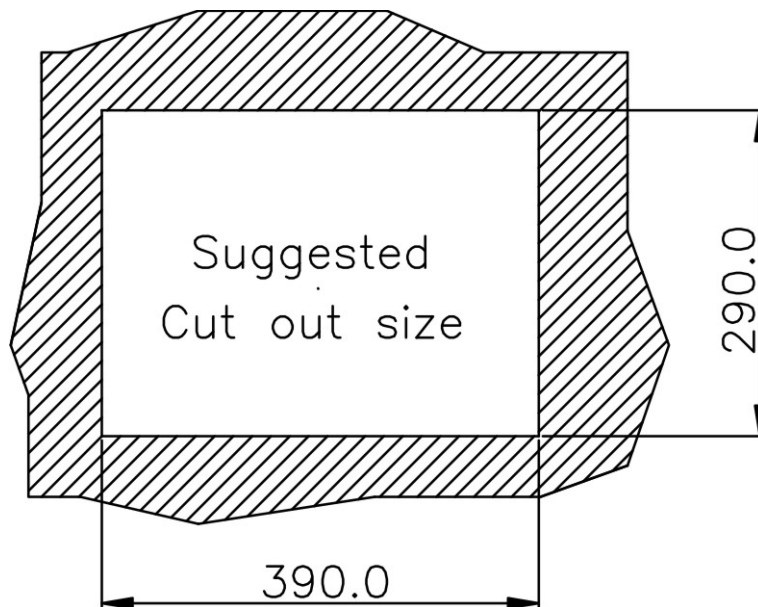

Figure 3-17: Suggested Panel Cut Out Size for PPC-5152-D525 (Unit: mm)

- Step 3:** Slide the flat panel computer through the previously cut hole. The chassis at the rear of the flat panel should slide easily through the hole. Only stop sliding the panel through the hole when the back of the front aluminum frame is flush against the panel.
- Step 4:** Insert the panel mounting clamps into the pre-formed holes along the edges of the chassis, behind the frame. There are a total of 6 panel mounting clamps for PPC-5152-D525.

PPC-5152-D525 Falt-bezel Panel PC

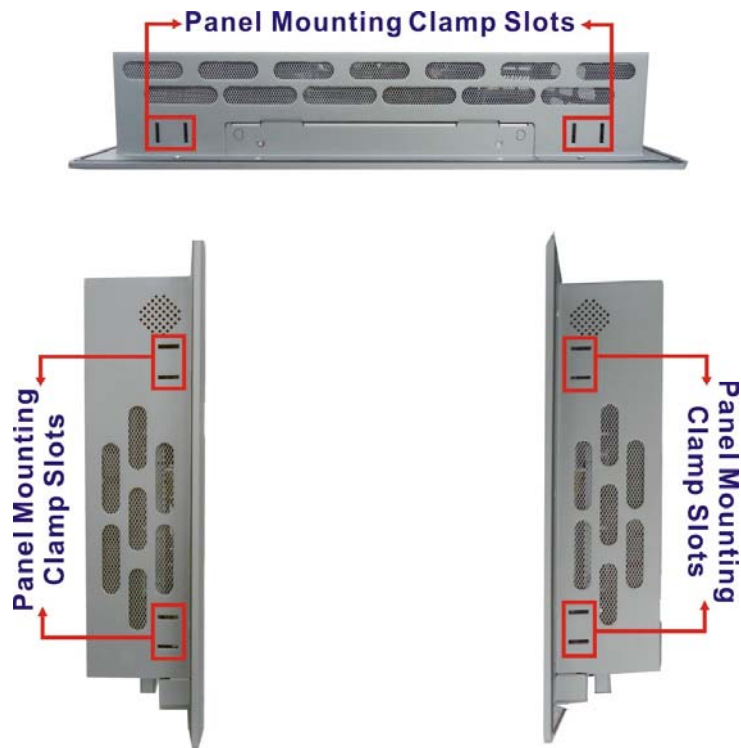

Figure 3-18: Panel Mounting Clamp Slots (Side View)

Step 5: Tighten the screws that pass through the panel mounting clamps until the plastic caps at the front of all the screws are firmly secured to the panel (**Figure 3-19**).

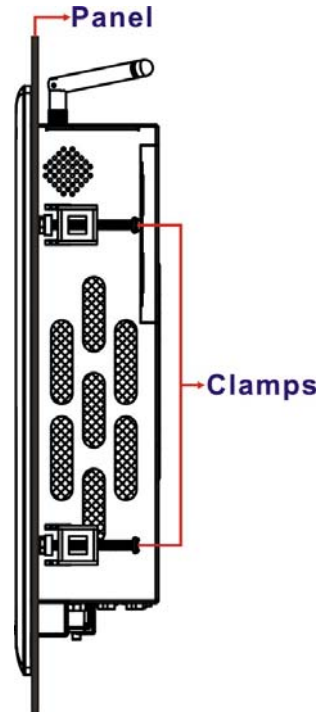

Figure 3-19: Tighten the Panel Mounting Clamp Screws

3.10.3 Rack/Cabinet Mounting

The PPC-5152-D525 panel PC can be installed into a rack or cabinet. The installation procedures are similar to the panel mounting installation. To do this, please follow the steps below:



NOTE:

When purchasing the cabinet/rack installation bracket, make sure it is compatible with both the PPC-5152-D525 flat panel PC and the rack/cabinet into which the PPC-5152-D525 is installed.

- Step 1:** Slide the rear of the PPC-5152-D525 panel PC through the rack/cabinet bracket until the aluminum frame is flush against the front of the bracket (**Figure 3-20**).

PPC-5152-D525 Falt-bezel Panel PC

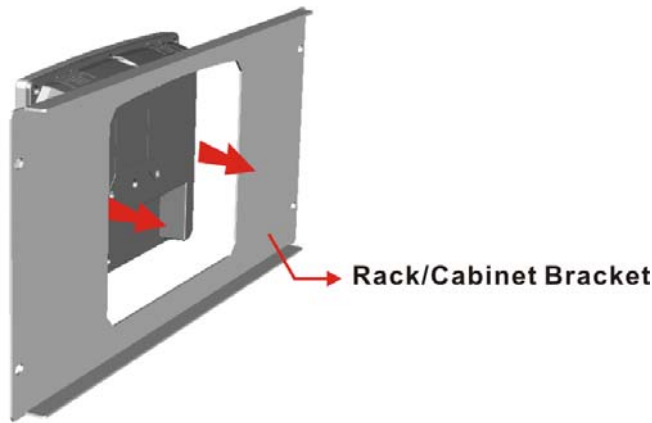

Figure 3-20: The Rack/Cabinet Bracket

Step 2: Insert the rack mounting clamps into the pre-formed holes along the edges of the panel PC, behind the ABS/PC plastic frame.

Step 3: Tighten the screws that pass through the rack mounting clamps until the plastic caps at the front of all the screws are firmly secured to the bracket (Figure 3-21).

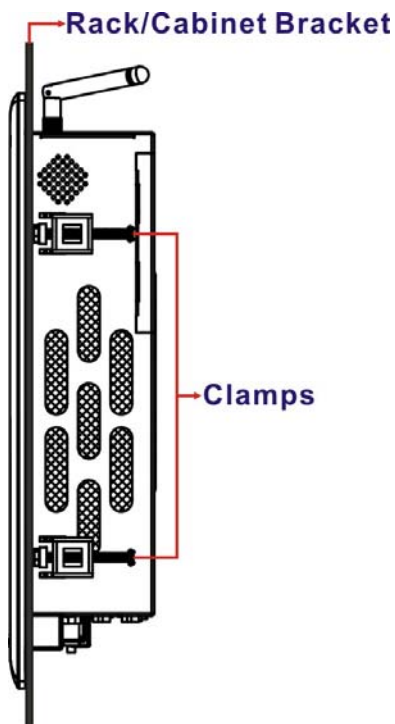

Figure 3-21: Secure the Rack/Cabinet Bracket

Step 4: Slide the panel PC with the attached rack/cabinet bracket into a rack or cabinet (Figure 3-22).

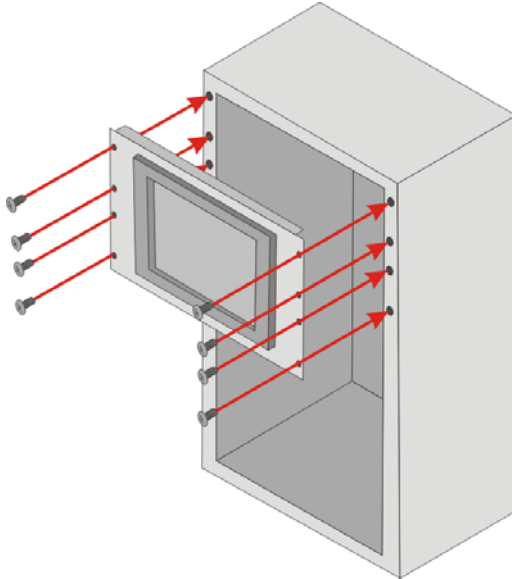

Figure 3-22: Install into a Rack/Cabinet

Step 5: Once the panel PC with the attached rack/cabinet bracket has been properly inserted into the rack or cabinet, secure the front of the rack/cabinet bracket to the front of the rack or cabinet (Figure 3-22).

3.10.4 Stand Mounting

The PPC-5152-D525 can be installed on any stand that supports the standard VESA mounting interface. An example stand is shown below.



Figure 3-23: VESA Compliant Stand

To install the PPC-5152-D525 on the stand, follow the directions below.

PPC-5152-D525 Falt-bezel Panel PC

Step 1: Locate the screw holes on the rear of the PPC-5152-D525. This is where the stand bracket will be attached. The stand mount retention screw holes are shown in **Figure 3-24**.

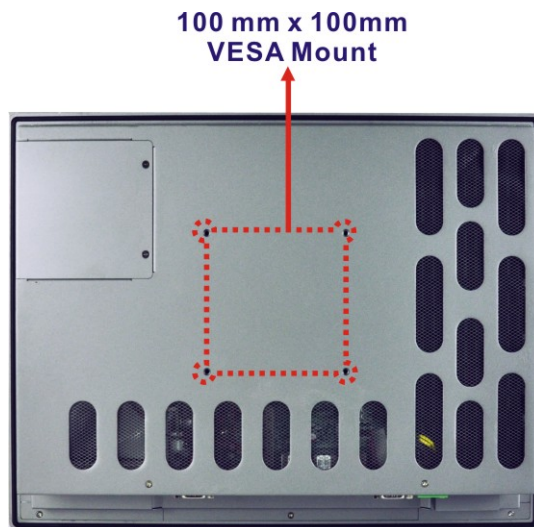

Figure 3-24: Stand Mounting Retention Screw Holes

Step 2: Align the bracket with the screw holes.

Step 3: Insert the retention screws into the screw holes to secure the bracket to the PPC-5152-D525.

3.10.5 Wall Mounting

To mount the panel PC onto the wall, please follow the steps below.

Step 1: Select the location on the wall for the wall-mounting bracket.

Step 2: Carefully mark the locations of the four brackets screw holes on the wall.

Step 3: Drill four pilot holes at the marked locations on the wall for the bracket retention screws.

Step 4: Align the wall-mounting bracket screw holes with the pilot holes.

Step 5: Secure the mounting-bracket to the wall by inserting the retention screws into the four pilot holes and tightening them (Figure 3-25).

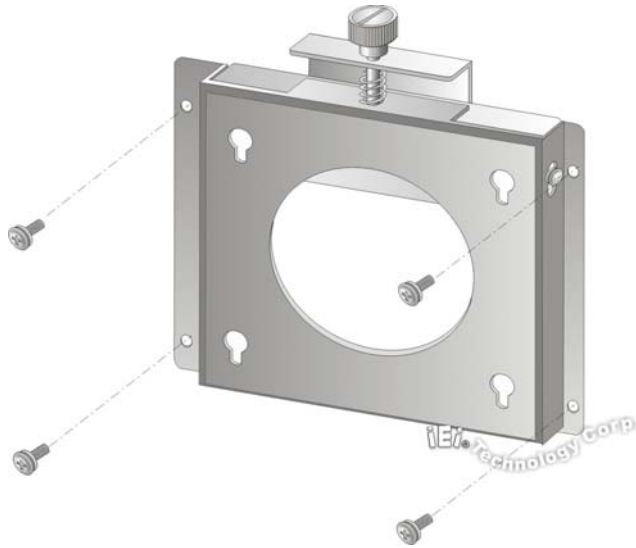

Figure 3-25: Wall-mounting Bracket

- Step 6:** Insert the four monitor mounting screws provided in the wall mounting kit into the four screw holes on the rear panel of the flat panel PC and tighten until the screw shank is secured against the rear panel (Figure 3-26).
- Step 7:** Align the mounting screws on the monitor rear panel with the mounting holes on the bracket.
- Step 8:** Carefully insert the screws through the holes and gently pull the monitor downwards until the monitor rests securely in the slotted holes (Figure 3-26). Ensure that all four of the mounting screws fit snugly into their respective slotted holes.

PPC-5152-D525 Falt-bezel Panel PC

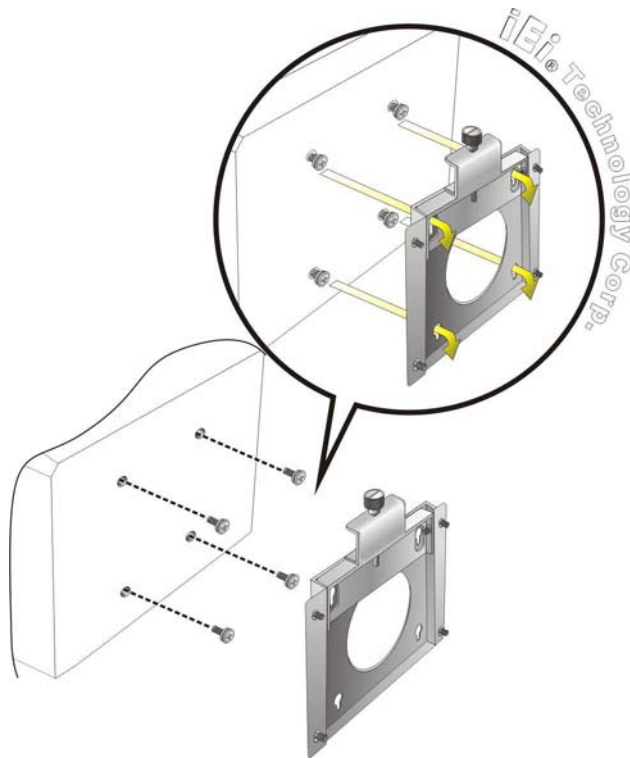

Figure 3-26: Chassis Support Screws



NOTE:

In the diagram below the bracket is already installed on the wall.

-
- Step 9:** Secure the panel PC by fastening the retention screw of the wall-mounting bracket. (Figure 3-27).

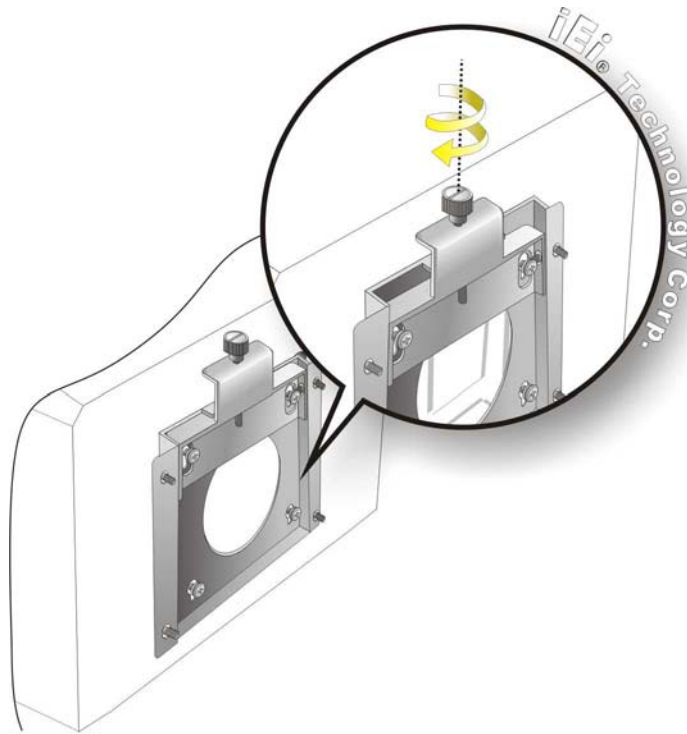

Figure 3-27: Secure the Panel PC

3.11 Bottom Panel Connectors

The bottom panel of the PPC-5152-D525 contains I/O connectors, switches and a CF card slot. Detailed descriptions of the connectors can be found in the subsections below.

3.11.1 Audio Connectors

The audio jacks connect to external audio devices.

- **Microphone (Pink):** Connects a microphone.
- **Line Out port (Green):** Connects to a headphone or a speaker. With multi-channel configurations, this port can also connect to front speakers.

PPC-5152-D525 Falt-bezel Panel PC

3.11.2 LAN Connector

The LAN connector allows connection to an external network. The pinouts of the RJ-45 LAN connector is shown below.

Pin	Description	Pin	Description
1	MDI0+	2	MDI0-
3	MDI1+	4	MDI1-
5	MDI2+	6	MDI2-
7	MDI3+	8	MDI3-

Table 3-1: LAN Pinouts

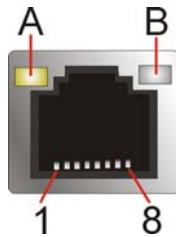

Figure 3-28: RJ-45 Ethernet Connector

The RJ-45 Ethernet connector has two status LEDs, one green and one yellow. See **Figure 3-28**.

LED	Description	LED	Description
A	on: linked blinking: data is being sent/received	B	off: 10 Mb/s green: 100 Mb/s orange: 1000 Mb/s

Table 3-2: RJ-45 Ethernet Connector LEDs

To connect the PPC-5152-D525 to a network through the RJ-45 LAN connector, follow the steps below.

Step 1: Locate the RJ-45 connector. The location of the RJ-45 connectors is shown in

Figure 1-4.

Step 2: Align the connectors. Align the RJ-45 connector on the LAN cable with one of the RJ-45 connectors on the PPC-5152-D525. See **Figure 3-29**.

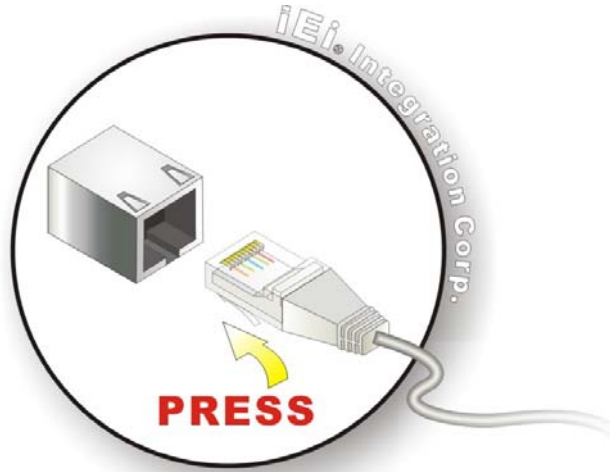

Figure 3-29: LAN Connection

Step 3: Insert the LAN cable RJ-45 connector. Once aligned, gently insert the LAN cable RJ-45 connector into the on-board RJ-45 connector.

3.11.3 Power Input, 2-pin Terminal Block

CN Label:	DC IN
CN Type:	3-pin terminal block
CN Location:	See Figure 1-4
CN Pinouts:	See Figure 3-30

Connect the leads of a 9 V~36 V DC power supply into the terminal block. Make sure that the power and ground wires are attached to the correct sockets of the connector.

PPC-5152-D525 Falt-bezel Panel PC

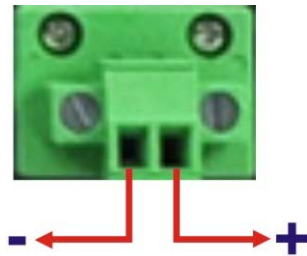

Figure 3-30: 2-pin Terminal Block Pinouts

The PPC-5152-D525 comes with a pluggable DC-in terminal block. To install the terminal block into the power input connector, follow the steps below.

- Step 1:** Locate the 2-pin power input connector. The location of the power input connector is shown in **Figure 1-4**.
- Step 2:** Insert the terminal block into the 2-pin power input connector on the external peripheral interface.
- Step 3:** Secure the terminal block to the external interface by tightening the two slot head screws. See **Figure 3-34**.

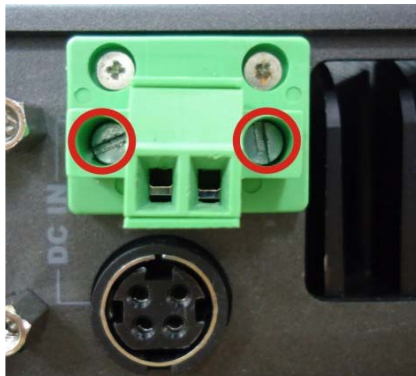

Figure 3-31: Power Input Terminal Block Installation

3.11.4 Power Input, DIN Connector

- CN Label:** DC IN
- CN Type:** 4-pin DIN connector
- CN Location:** See **Figure 1-4**

The power connector connects to the 9 V ~ 36 V DC power adapter.

3.11.5 RS-232 Serial Port (COM1, COM2)

- CN Label:** COM1, COM2
- CN Type:** DB-9 connector
- CN Location:** See **Figure 1-4**
- CN Pinouts:** See **Table 3-4** and **Figure 3-33**

An RS-232 device can be connected to the RS-232 serial port on the bottom panel. The pinouts of the RS-232 serial port is shown below.

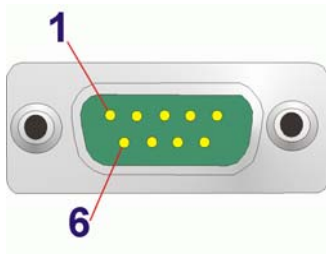

Figure 3-32: RS-232 Serial Port

Pin	Description
1	DCD
2	DSR
3	RX
4	RTS
5	TX
6	CTS
7	DTR
8	RI
9	GND

Table 3-3: RS-232 Serial Port Pinouts

PPC-5152-D525 Falt-bezel Panel PC

3.11.6 RS-232/422/485 Serial Port (COM3)

- CN Label:** COM3
- CN Type:** DB-9 connector
- CN Location:** See **Figure 1-4**
- CN Pinouts:** See **Table 3-4** and **Figure 3-33**

An RS-232/422/485 device can be connected to the RS-232/422/485 serial port on the bottom panel. The pinouts of the RS-232/422/485 serial port is shown below.

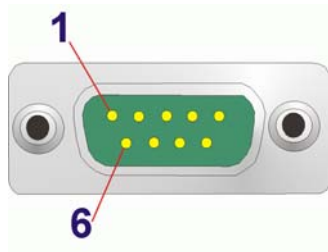

Figure 3-33: RS-232/422/485 Serial Port

Pin	RS-232	RS-422	RS-485
1	DCD	RX+	
2	RXD	RX-	
3	TXD	TX+	DATA+
4	DTR	TX-	DATA-
5	GND		
6	DSR		
7	RTS		
8	CTS		
9	RI		

Table 3-4: RS-232/422/485 Serial Port Pinouts

To install the RS-232/422/485 devices, follow the steps below.

- Step 1:** Locate the DB-9 connector. The locations of the DB-9 connectors are shown in **Figure 1-4**.

Step 2: Insert the serial connector. Insert the DB-9 connector of a serial device into the DB-9 connector on the external peripheral interface. See **Figure 3-34**.

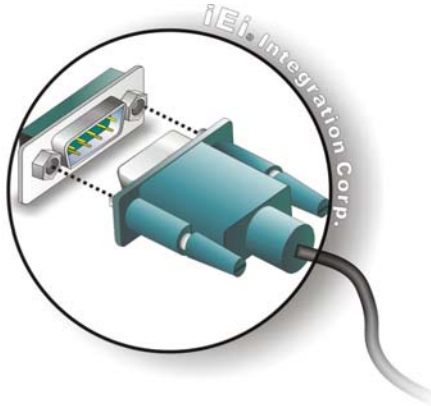

Figure 3-34: Serial Device Connector

Step 3: Secure the connector. Secure the serial device connector to the external interface by tightening the two retention screws on either side of the connector.

3.11.6.1 COM3 Mode Select Switch

- Jumper Label:** U61
- Jumper Type:** 10-pin DIP switch
- Jumper Settings:** See **Table 3-5**
- Jumper Location:** See **Figure 3-35**

The COM3 RS-232/422/485 Serial Port Select jumper sets the communication protocol used by the second serial communications port (COM3) as RS-232, RS-422 or RS-485. The COM3 RS-232/422/485 Serial Port Select settings are shown in **Table 3-5**.

COM3 Mode	Settings
RS-232 (Default)	OFF: 1, 2, 3, 4, 5 ON: 6, 7, 8, 9, 10
RS-422/485	OFF: 6, 7, 8, 9, 10 ON: 1, 2, 3, 4, 5

Table 3-5: COM3 RS-232/422/485 Serial Port Select Settings

PPC-5152-D525 Falt-bezel Panel PC

The COM3 RS-232/422/485 Serial Port Select jumper location is shown in **Figure 3-35**.

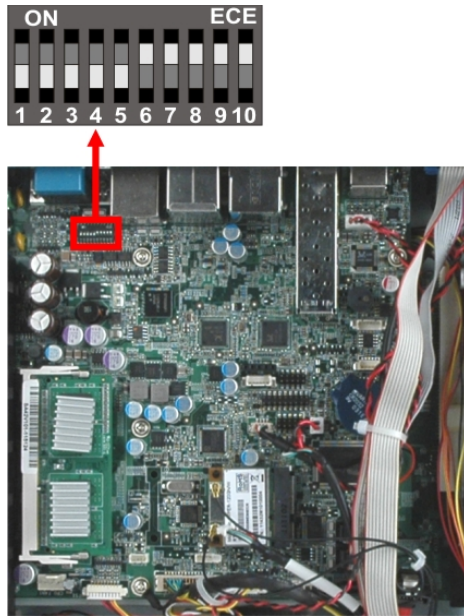

Figure 3-35: COM3 RS-232/422/485 Serial Port Select Switch Location

3.11.7 RJ-45 RS-422/485 Serial Port (COM4, COM5)

- CN Label:** COM4, COM5
- CN Type:** RJ-45
- CN Location:** See **Figure 1-4**
- CN Pinouts:** See **Table 3-6** and **Figure 3-36**

An RS-422/485 serial port device can be connected to the RJ-45 RS-422/485 serial port on the bottom panel. The pinouts of the RJ-45 RS-422/485 serial port is shown below.

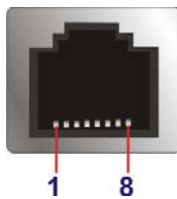

Figure 3-36: RJ-45 RS-422/485 Serial Port

Pin	Description	Pin	Description
1	N/A	5	N/A

Pin	Description	Pin	Description
2	TXD485#	6	RXD485#
3.	N/A	7	N/A
4.	TXD485+	8	RXD485+

Table 3-6: RJ-45 RS-422/485 Serial Port Pinouts

To install the RS-422/485 devices, follow the steps below.

Step 1: Locate the RJ-45 RS-422/485 connector. The location of the RJ-45 RS-422/485 connector is shown in **Figure 1-4**.

Step 2: Insert the RJ-45 connector. Insert the RJ-45 connector on the RJ-45 to DB-9 COM port cable to the RJ-45 RS-422/485 connector on the PPC-5152-D525. See **Figure 3-37**.

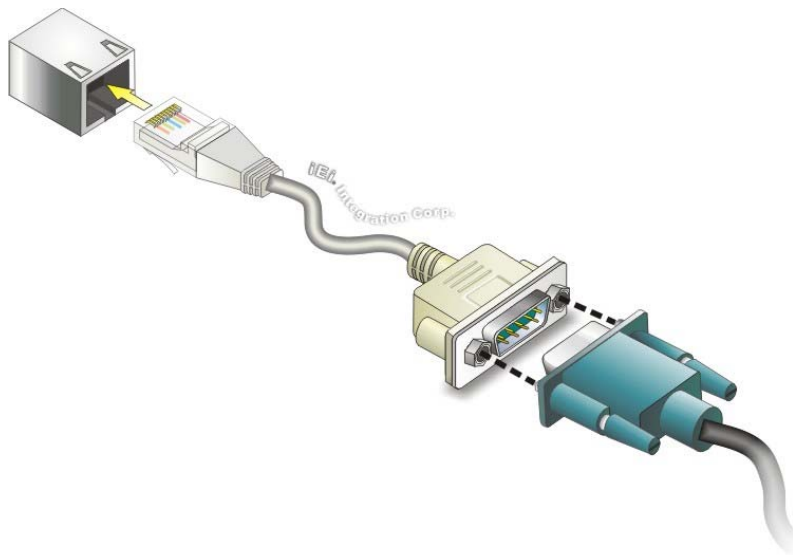

Figure 3-37: RJ-45 RS-422/485 Serial Device Connection

Step 3: Insert the serial connector. Insert the DB-9 connector of a serial device into the DB-9 connector on the RJ-45 to DB-9 COM port cable.

Step 4: Secure the connector. Secure the serial device connector to the external interface by tightening the two retention screws on either side of the connector.

PPC-5152-D525 Falt-bezel Panel PC

Step 5: The DB-9 connector pinouts are listed below.

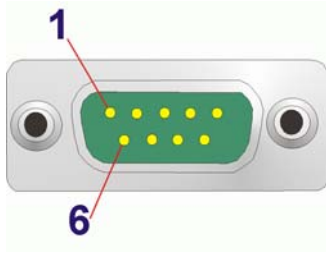

Figure 3-38: RS-422/485 Serial Port (DB-9)

Pin	RS-422	RS-485
1	RX+	--
2	RX-	--
3	TX+	DATA+
4	TX-	DATA-
5	--	--
6	--	--
7	--	--
8	--	--
9	--	--

Table 3-7: RS-422/485 Serial Port Pinouts

3.11.8 SFP Fiber Connectors

The PPC-5152-D525 has two SFP fiber connectors. The locations of the connectors are shown in **Figure 1-4**. To install an SFP module, refer to **Section 3.6**.

3.11.9 USB 2.0 Connectors

- CN Label:** USB2.0
- CN Type:** USB 2.0 port
- CN Location:** See **Figure 1-4**
- CN Pinouts:** See **Table 3-8**

The USB 2.0 ports are for attaching USB 2.0 peripheral devices to the system. The pinouts of the USB 2.0 port is shown below.

Pin	Description	Pin	Description
1	VCC	5	VCC
2	DATA-	6	DATA-
3	DATA+	7	DATA+
4	GROUND	8	GROUND

Table 3-8: USB 2.0 Port Pinouts

3.11.10 USB 3.0 Connectors

- CN Label:** USB3.0
- CN Type:** USB 3.0 port
- CN Location:** See **Figure 1-4**
- CN Pinouts:** See **Table 3-8**

The USB 3.0 ports are for attaching USB 3.0 peripheral devices to the system. To be able to use the USB 3.0 ports, please make sure the USB 3.0 function is enabled in BIOS (see **Section 5.3.4**).

The pinouts of the USB 3.0 port is shown below.

Pin	Description	Pin	Description
1	USB_3PO_VCC1	10	USB_3PO_VCC2
2	DATA1-	11	DATA2-
3	DATA1+	12	DATA2+
4	GROUND	13	GROUND
5	RX1N	14	RX2N
6	RX1P	15	RX2P
7	GROUND	16	GROUND
8	TX1N	17	TX2N
9	TX1P	18	TX2P

Table 3-9: USB 3.0 Port Pinouts

PPC-5152-D525 Falt-bezel Panel PC

To install a USB device, follow the steps below.

Step 1: Locate the USB connectors. The locations of the USB connectors are shown in Figure 1-4.

Step 2: Align the connectors. Align the USB device connector with one of the connectors. See **Figure 3-39**.

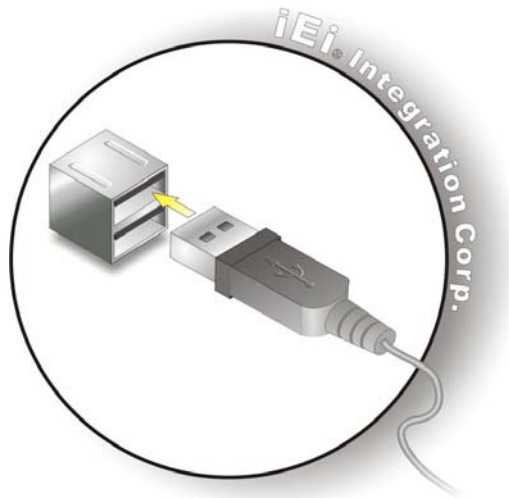

Figure 3-39: USB Device Connection

Step 3: Insert the device connector. Once aligned, gently insert the USB device connector into the on-board connector.

3.11.11 VGA Connector

CN Label:	VGA
CN Type:	15-pin Female
CN Location:	See Figure 1-4
CN Pinouts:	See Figure 3-40 and Table 3-10

The VGA connector connects to a monitor that accepts VGA video input. The pinouts of the VGA connector is shown below.

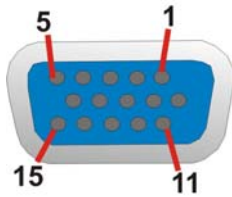

Figure 3-40: VGA Connector

Pin	Description	Pin	Description
1	RED	2	GREEN
3	BLUE	4	NC
5	GND	6	GND
7	GND	8	GND
9	CRT_VCC	10	GND
11	NC	12	5VDDC DAT
13	HSYNC	14	VSYNC
15	5VDDCCLK		

Table 3-10: VGA Connector Pinouts

To connect the PPC-5152-D525 to a second display, follow the steps below,

- Step 1:** Locate the female DB-15 connector. The location of the female DB-15 connector is shown in **Figure 1-4**.
- Step 2:** Align the VGA connector. Align the male DB-15 connector on the VGA screen cable with the female DB-15 connector on the external peripheral interface.
- Step 3:** Insert the VGA connector. Once the connectors are properly aligned with the insert the male connector from the VGA screen into the female connector on the PPC-5152-D525. See **Figure 3-41**.

PPC-5152-D525 Flat-bezel Panel PC

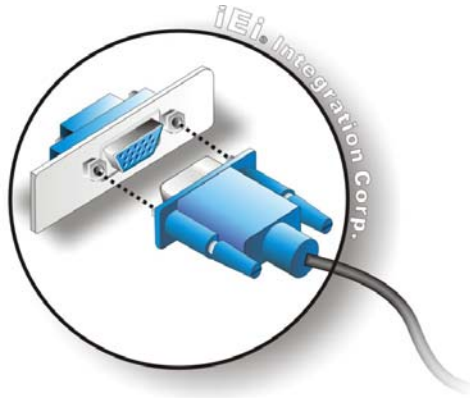

Figure 3-41: VGA Connector

3.12 Power-up the System



WARNING:

Make sure a power supply with the correct input voltage is being fed into the system. Incorrect voltages applied to the system may cause damage to the internal electronic components and may also cause injury to the user.

3.12.1 AT/ATX Power Mode Selection

The PPC-5152-D525 supports both AT and ATX power modes. The setting can be made through the AT/ATX power mode switch on the bottom panel as shown below.

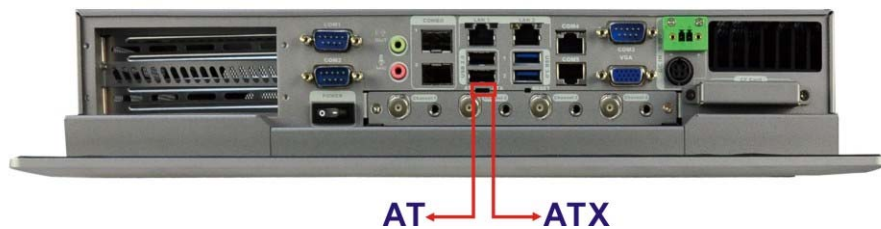

Figure 3-42: AT/ATX Power Mode Switch

3.12.2 Powering On/Off in ATX Power Mode

- **Power on** the system: press the power button for 3 seconds
- **Power off** the system: press the power button for 6 seconds



Figure 3-43: Power Button

3.13 Remote Control

The PPC-5152-D525 comes with a remote control for easy configuration. **Figure 3-44** shows the remote control and its function keys.

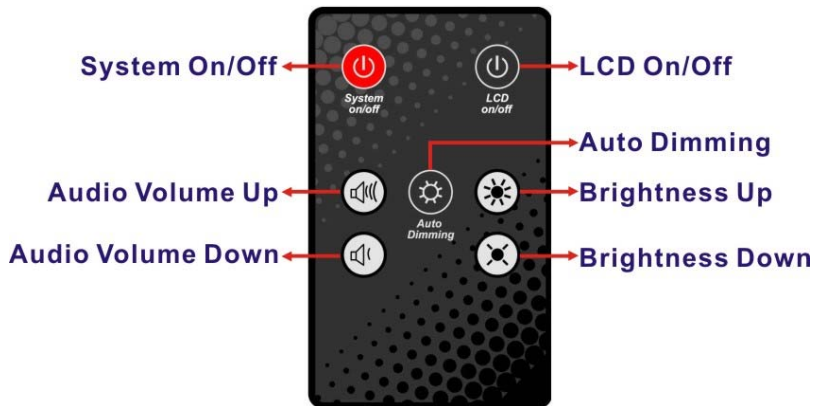

Figure 3-44: Remote Control

- **System On/Off**: Press this button to turn the PPC-5152-D525 on or off.
- **LCD On/Off**: Press this button to turn the LCD monitor on or off.
- **Auto-Dimming**: Press this button to turn the auto-dimming function on or off.
- **Brightness**: Use these control buttons to adjust the brightness of the LCD screen.
- **Volume**: Press these buttons to adjust the audio volume level.

Chapter

4

System Maintenance

4.1 System Maintenance Introduction

If the components of the PPC-5152-D525 fail they must be replaced. Components that can be replaced include:

- SO-DIMM module
- WLAN Module

Please contact the system reseller or vendor to purchase the replacement parts. Back cover removal instructions for the PPC-5152-D525 are described below.

4.2 Anti-static Precautions



WARNING:

Failure to take ESD precautions during the maintenance of the PPC-5152-D525 may result in permanent damage to the PPC-5152-D525 and severe injury to the user.

Electrostatic discharge (ESD) can cause serious damage to electronic components, including the PPC-5152-D525. Dry climates are especially susceptible to ESD. It is therefore critical that whenever the PPC-5152-D525 is accessed internally, or any other electrical component is handled, the following anti-static precautions are strictly adhered to.

- ***Wear an anti-static wristband:*** - Wearing a simple anti-static wristband can help to prevent ESD from damaging the board.
- ***Self-grounding:*** - Before handling the board touch any grounded conducting material. During the time the board is handled, frequently touch any conducting materials that are connected to the ground.
- ***Use an anti-static pad:*** - When configuring the PPC-5152-D525, place it on an antic-static pad. This reduces the possibility of ESD damaging the PPC-5152-D525.
- ***Only handle the edges of the PCB:*** - When handling the PCB, hold the PCB by the edges.

PPC-5152-D525 Falt-bezel Panel PC

4.3 Turn off the Power

**WARNING:**

Failing to turn off the system before opening it can cause permanent damage to the system and serious or fatal injury to the user.

Before any maintenance procedures are carried out on the system, make sure the system is turned off.

To power off the system, follow the steps below:

Step 1: Locate the power switch. See **Figure 3-43**.

Step 2: Hold down the power switch for **six** seconds to power off the system.

4.4 Opening the System

To access the PPC-5152-D525 internally the back cover must be removed. To remove the back cover, please follow the steps below.

Step 1: Follow all anti-static procedures. See **Section 4.2**.

Step 2: Turn off the power. See **Section 4.3**.

Step 3: Remove a total of ten retention screws from the back cover, eight on the rear of the frame and two on the rear panel (**Figure 4-1**).

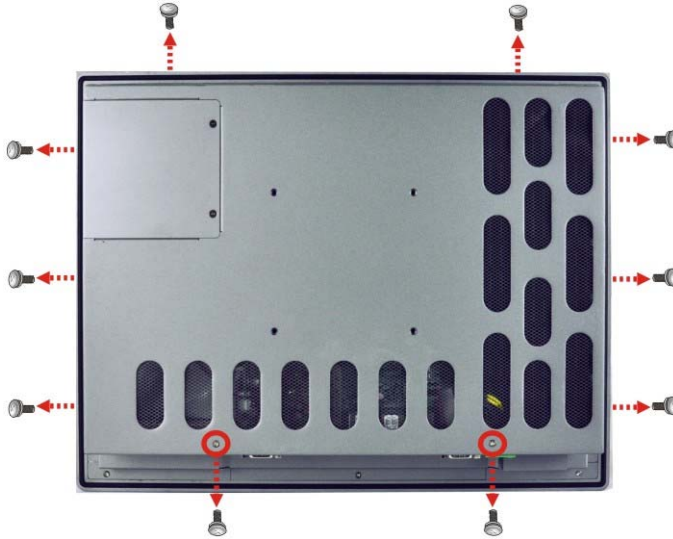

Figure 4-1: Back Cover Retention Screws

Step 4: Carefully separate the back cover from the chassis and lift the cover clear of the device

4.5 Replacing Components

4.5.1 Memory Module Replacement

The flat bezel panel PC is preinstalled with a 1.0 GB DDR3 memory module. If the memory module fails, follow the instructions below to replace the memory module.

Step 1: Follow all anti-static procedures. See **Section 4.2**.

Step 2: Turn off the power. See **Section 4.3**.

Step 3: Remove the back cover. See **Section 4.4** above.

Step 4: Locate the DDR3 SO-DIMM on the motherboard.

Step 5: Remove the DDR3 memory module by pulling both the spring retainer clips outward from the socket.

PPC-5152-D525 Falt-bezel Panel PC

- Step 6:** Grasp the DDR3 memory module by the edges and carefully pull it out of the socket.
- Step 7:** Install the new DDR3 memory module by pushing it into the socket at an angle (Figure 4-2).
- Step 8:** Gently pull the spring retainer clips of the SO-DIMM socket out and push the rear of the DDR memory module down (Figure 4-2).
- Step 9:** Release the spring retainer clips on the SO-DIMM socket. They clip into place and secure the DDR memory module in the socket.

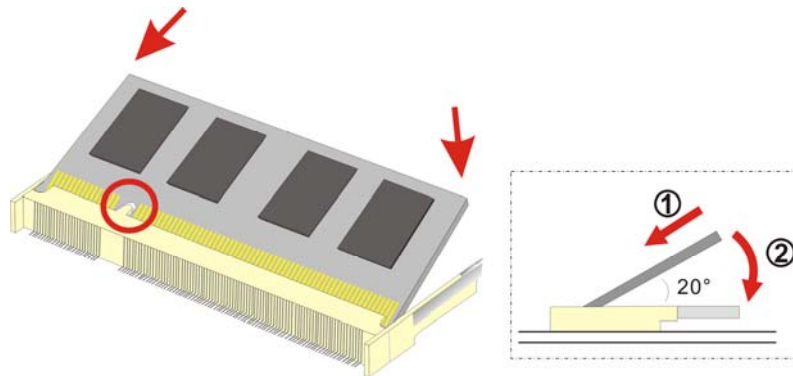

Figure 4-2: DDR SO-DIMM Module Installation

- Step 10:** Replace the internal aluminum cover and secure it to the chassis using six (6) retention screws.
- Step 11:** Replace the back cover and secure it using nine (9) previously removed retention screws.

4.5.2 WLAN Card Replacement

The PPC-5152-D525 has one WLAN card slot. To replace the WLAN card, follow the instructions below.

- Step 1:** Follow all anti-static procedures. See **Section 4.2**.
- Step 2:** Turn off the power. See **Section 4.3**.
- Step 3:** Remove the back cover. See **Section 4.4**.

Step 4: Locate the WLAN card.

Step 5: Disconnect the main and auxiliary antennas on the WLAN module
(Figure 4-3).



Figure 4-3: Removing the Antennas

Step 6: Push the two spring clips in to release the WLAN card.



Figure 4-4: Releasing the WLAN Card

PPC-5152-D525 Falt-bezel Panel PC

- Step 7:** Grasp the WLAN card by the edges and carefully pull it out of the socket (Figure 4-5).

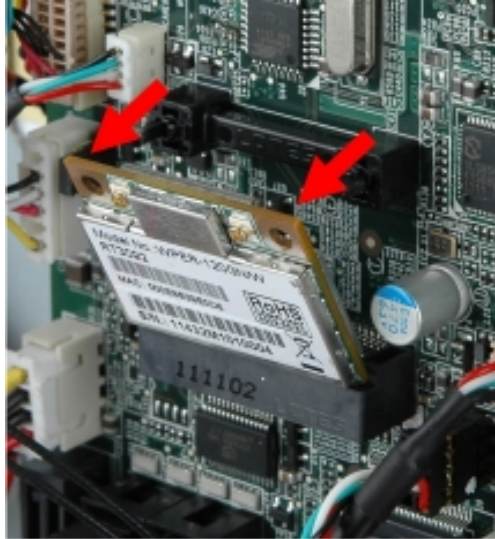

Figure 4-5: Removing the WLAN card

- Step 8:** Install a new WLAN card by inserting the card into the slot at an angle
- Step 9:** Push the WLAN card down until the spring retainer clips lock into place.
- Step 10:** Connect the main (1) and auxiliary (2) antennas. The main antenna is indicated with a strip of black electrical tape. See **Figure 4-6**.



NOTE:

To ensure the WLAN module functions correctly, please make sure the WLAN antennas are attached in the proper configuration.

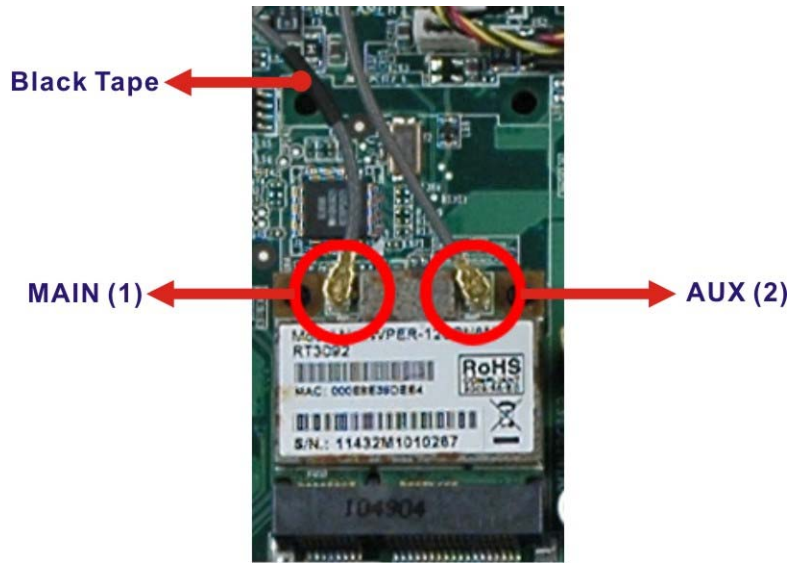

Figure 4-6: Attaching the Antennas

Step 11: Replace the internal aluminum cover and secure it to the chassis using six (6) retention screws.

Step 12: Replace the back cover and secure it using nine (9) previously removed retention screws.

Chapter

5

AMI BIOS Setup

5.1 Introduction

The BIOS is programmed onto the BIOS chip. The BIOS setup program allows changes to certain system settings. This chapter outlines the options that can be changed.



NOTE:

Some of the BIOS options may vary throughout the life cycle of the product and are subject to change without prior notice.

5.1.1 Starting Setup

The UEFI BIOS is activated when the computer is turned on. The setup program can be activated in one of two ways.

1. Press the **DELETE** or **F2** key as soon as the system is turned on or
2. Press the **DELETE** or **F2** key when the “**Press DELETE or F2 to enter SETUP**” message appears on the screen.

If the message disappears before the **DELETE** or **F2** key is pressed, restart the computer and try again.

5.1.2 Using Setup

Use the arrow keys to highlight items, press **ENTER** to select, use the PageUp and PageDown keys to change entries, press **F1** for help and press **ESC** to quit. Navigation keys are shown in the following table.

Key	Function
Up arrow	Move to the item above
Down arrow	Move to the item below
Left arrow	Move to the item on the left hand side
Right arrow	Move to the item on the right hand side

PPC-5152-D525 Falt-bezel Panel PC

Key	Function
+	Increase the numeric value or make changes
-	Decrease the numeric value or make changes
Page up	Move to the next page
Page down	Move to the previous page
Esc	Main Menu – Quit and do not save changes into CMOS Status Page Setup Menu and Option Page Setup Menu -- Exit current page and return to Main Menu
F1	General help, only for Status Page Setup Menu and Option Page Setup Menu
F9	Load optimized defaults
F10	Save changes and Exit BIOS

Table 5-1: BIOS Navigation Keys

5.1.3 Getting Help

When **F1** is pressed a small help window describing the appropriate keys to use and the possible selections for the highlighted item appears. To exit the Help Window press **Esc** or the **F1** key again.

5.1.4 BIOS Menu Bar

The **menu bar** on top of the BIOS screen has the following main items:

- Main – Changes the basic system configuration.
- Advanced – Changes the advanced system settings.
- Chipset – Changes the chipset settings.
- Boot – Changes the system boot configuration.
- Save & Exit – Selects exit options and loads default settings

The following sections completely describe the configuration options found in the menu items at the top of the BIOS screen and listed above.

5.2 Main

The **Main** BIOS menu (**BIOS Menu 1**) appears when the **BIOS Setup** program is entered. The **Main** menu gives an overview of the basic system information.

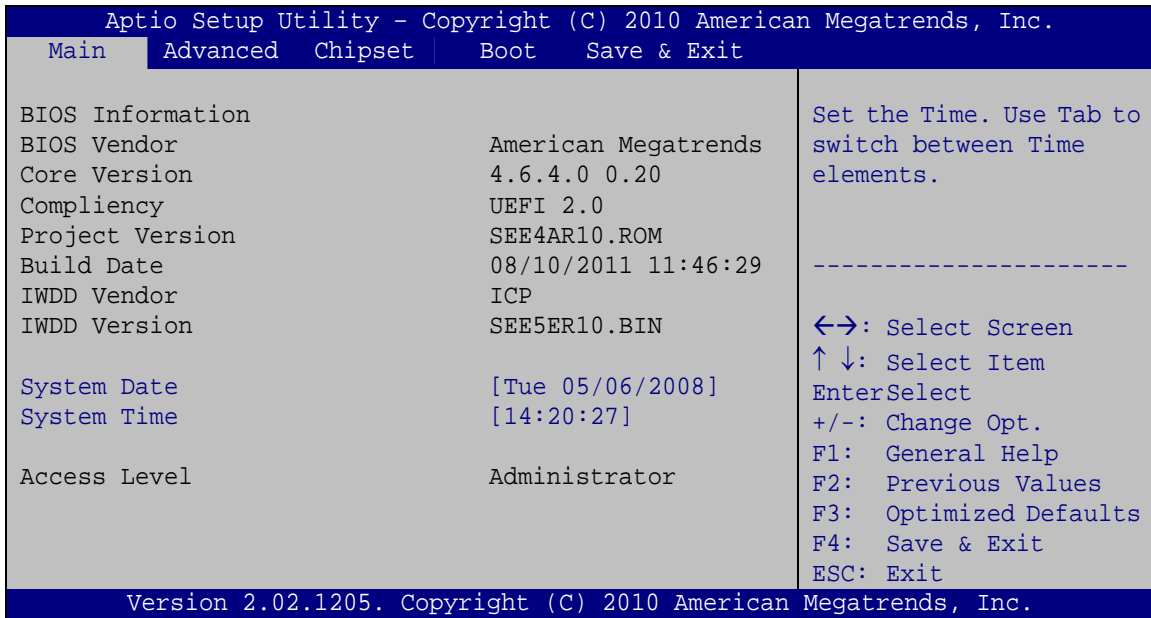

BIOS Menu 1: Main

→ BIOS Information

The **BIOS Information** lists a brief summary of the BIOS. The fields in **BIOS Information** cannot be changed. The items shown in the system overview include:

- **BIOS Vendor:** Installed BIOS vendor
- **Core Version:** Current BIOS version
- **Compliancy:** compliant UEFI specification version
- **Project Version:** the board version
- **Build Date:** Date the current BIOS version was made

→ System Date [xx/xx/xx]

Use the **System Date** option to set the system date. Manually enter the day, month and year.

PPC-5152-D525 Falt-bezel Panel PC

→ System Time [xx:xx:xx]

Use the **System Time** option to set the system time. Manually enter the hours, minutes and seconds.

5.3 Advanced

Use the **Advanced** menu (**BIOS Menu 2**) to configure the CPU and peripheral devices through the following sub-menus:



WARNING!

Setting the wrong values in the sections below may cause the system to malfunction. Make sure that the settings made are compatible with the hardware.

```

Aptio Setup Utility - Copyright (C) 2010 American Megatrends, Inc.
Main  Advanced  Chipset  Boot  Save & Exit
-----
> ACPI Settings
> CPU Configuration
> IDE Configuration
> USB Configuration
> Super IO Configuration
> H/M Monitor
> Serial Port Console Redirection
> iEi Feature

System ACPI Parameters
-----
<=>: Select Screen
↑ ↓: Select Item
Enter>Select
+/-: Change Opt.
F1: General Help
F2: Previous Values
F3: Optimized Defaults
F4: Save & Exit
ESC: Exit

Version 2.02.1205. Copyright (C) 2010 American Megatrends, Inc.
    
```

BIOS Menu 2: Advanced

5.3.1 ACPI Settings

The **ACPI Settings** menu (**BIOS Menu 3**) configures the Advanced Configuration and Power Interface (ACPI) options.

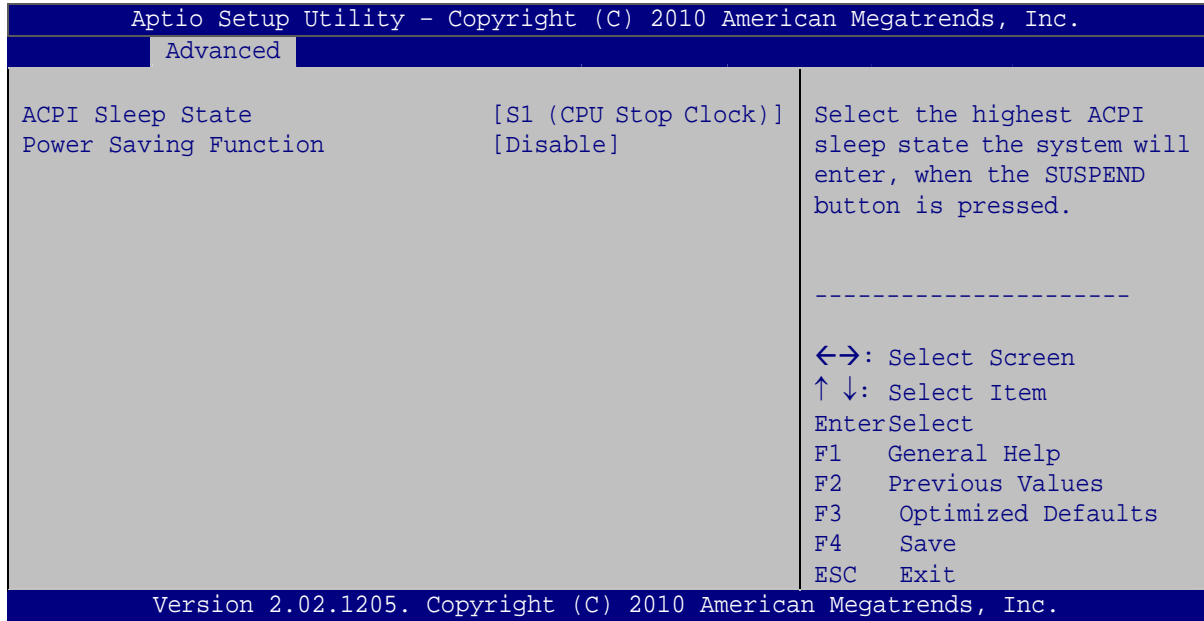

BIOS Menu 3: ACPI Configuration

→ ACPI Sleep State [S1 (CPU Stop Clock)]

Use the **ACPI Sleep State** option to specify the sleep state the system enters when it is not being used.

→ **S1 (CPU Stop Clock)** **DEFAULT** The system enters S1(POS) sleep state. The system appears off. The CPU is stopped; RAM is refreshed; the system is running in a low power mode.

→ **S3 (Suspend to RAM)** The caches are flushed and the CPU is powered off. Power to the RAM is maintained. The computer returns slower to a working state, but more power is saved.

→ Power Saving Function [Disabled]

Use the **Power Saving Function** BIOS option to enable the power saving function.

→ **Enabled** The power saving function enabled

→ **Disabled** **DEFAULT** The power saving function disabled

PPC-5152-D525 Fault-bezel Panel PC

5.3.2 CPU Configuration

Use the **CPU Configuration** menu (**BIOS Menu 4**) to view detailed CPU specifications and configure the CPU.

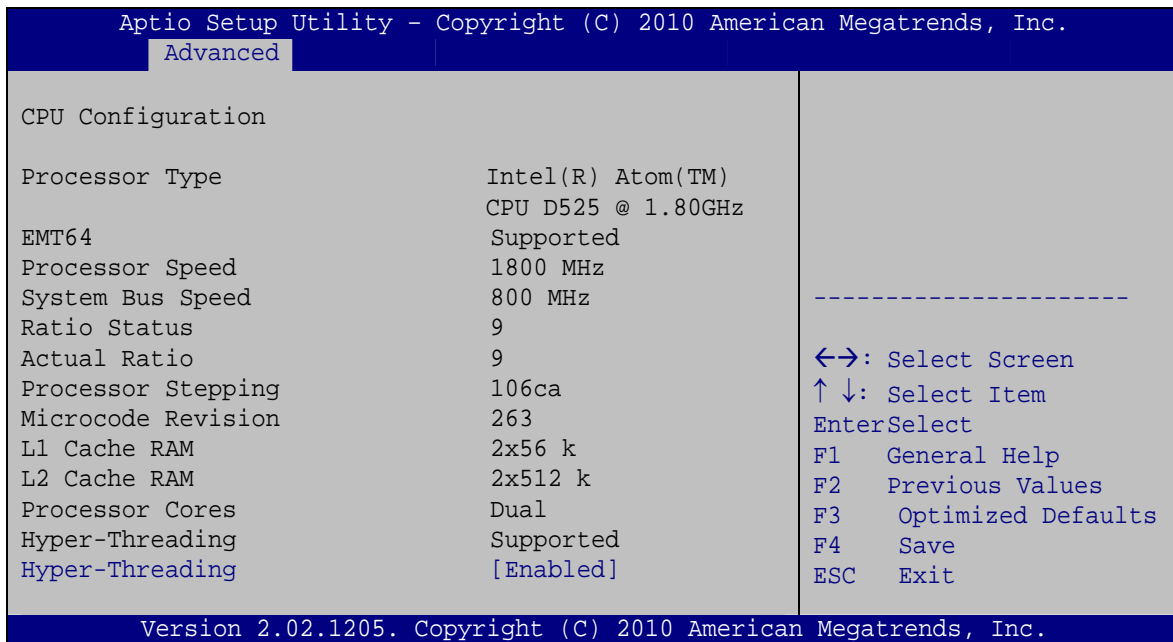
**BIOS Menu 4: CPU Configuration**

The CPU Configuration menu (**BIOS Menu 4**) lists the following CPU details:

- Processor Type: Lists the brand name of the CPU being used
- EMT64: Indicates if EM64T is supported by the CPU.
- Processor Speed: Lists the CPU processing speed
- System Bus Speed: Lists the system bus speed
- Ratio Status: Lists the ratio status
- Actual Ratio: Lists the actual ratio
- Processor Stepping: Lists the CPU processing stepping
- Microcode Revision: Lists the microcode revision
- L1 Cache RAM: Lists the amount of storage space on the L1 Cache
- L2 Cache RAM: Lists the amount of storage space on the L2 Cache
- Processor Core: Lists the number of the processor cores
- Hyper-Threading: Indicates if Hyper-Threading is supported by the CPU.
- Intel® Virtualization Technology [Disabled]

→ **Hyper Threading Function [Enabled]**

Use the Hyper Threading function to enable or disable the CPU hyper threading function.

- **Disabled** Disables the use of hyper threading technology
- **Enabled DEFAULT** Enables the use of hyper threading technology

5.3.3 IDE Configuration

Use the **IDE Configuration** menu (**BIOS Menu 5**) to change and/or set the configuration of the IDE or SATA devices installed in the system.

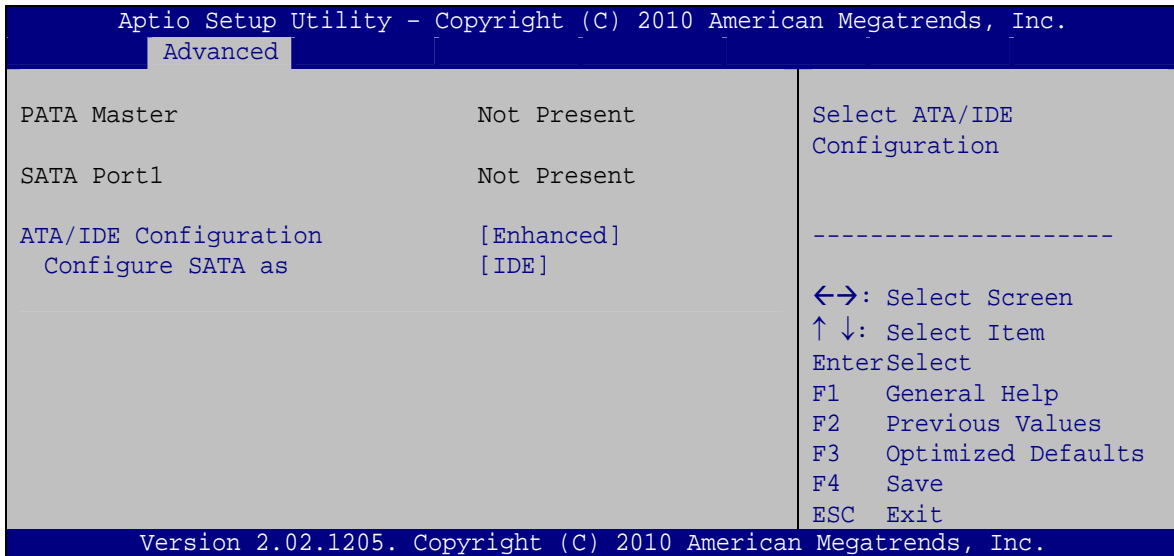

BIOS Menu 5: IDE Configuration

→ **ATA/IDE Configurations [Enhanced]**

Use the **ATA/IDE Configurations** option to configure the ATA/IDE controller.

- **Disabled** Disables the on-board ATA/IDE controller.
- **Compatible** Configures the on-board ATA/IDE controller to be in compatible mode. In this mode, a SATA channel will replace one of the IDE channels. This mode supports up to 4 storage devices.

PPC-5152-D525 Falt-bezel Panel PC

- ➔ **Enhanced** **DEFAULT** Configures the on-board ATA/IDE controller to be in Enhanced mode. In this mode, IDE channels and SATA channels are separated. This mode supports up to 6 storage devices. Some legacy OS do not support this mode.

➔ **Configure SATA as [IDE]**

Use the **Configure SATA as** option to configure SATA devices as normal IDE devices.

- ➔ **IDE** **DEFAULT** Configures SATA devices as normal IDE device.
- ➔ **AHCI** The SATA drive connected to the nth SATA drive port is specified as a normal SATA drive.

5.3.4 USB Configuration

Use the **USB Configuration** menu (**BIOS Menu 6**) to read USB configuration information and configure the USB settings.

```

Aptio Setup Utility - Copyright (C) 2010 American Megatrends, Inc.
  Advanced
-----
USB Configuration
USB Devices:
  1 Keyboard
Legacy USB Support      [Enabled]
USB3.0 Support          [Enabled]
-----
<=>: Select Screen
↑ ↓: Select Item
Enter>Select
F1  General Help
F2  Previous Values
F3  Optimized
    Defaults
F4  Save
ESC Exit
-----
Version 2.02.1205. Copyright (C) 2010 American Megatrends, Inc.
  
```

BIOS Menu 6: USB Configuration

→ **USB Devices**

The **USB Devices Enabled** field lists the USB devices that are enabled on the system

→ **Legacy USB Support [Enabled]**

Use the **Legacy USB Support** BIOS option to enable USB mouse and USB keyboard support. Normally if this option is not enabled, any attached USB mouse or USB keyboard does not become available until a USB compatible operating system is fully booted with all USB drivers loaded. When this option is enabled, any attached USB mouse or USB keyboard can control the system even when there is no USB driver loaded onto the system.

- | | | |
|-------------------|----------------|---|
| → Enabled | DEFAULT | Legacy USB support enabled |
| → Disabled | | Legacy USB support disabled |
| → Auto | | Legacy USB support disabled if no USB devices are connected |

→ **USB3.0 Support [Enabled]**

Use the **USB3.0 Support** BIOS option to enable the USB 3.0 support.

- | | | |
|-------------------|----------------|--------------------------|
| → Enabled | DEFAULT | USB 3.0 support enabled |
| → Disabled | | USB 3.0 support disabled |

PPC-5152-D525 Falt-bezel Panel PC

5.3.5 Super IO Configuration

Use the **Super IO Configuration** menu (**BIOS Menu 7**) to set or change the configurations for the FDD controllers, parallel ports and serial ports.

```

Aptio Setup Utility - Copyright (C) 2010 American Megatrends, Inc.
  Advanced
-----
Super IO Configuration
> Serial Port 1 Configuration
> Serial Port 2 Configuration
> Serial Port 3 Configuration
> Serial Port 4 Configuration
> Serial Port 5 Configuration
> Serial Port 6 Configuration
> Touch Controller Configuration

Set Parameters of Serial
Port 0 (COMA)

-----
<=>: Select Screen
↑↓: Select Item
EnterSelect
F1  General Help
F2  Previous Values
F3  Optimized Defaults
F4  Save
ESC Exit

Version 2.02.1205. Copyright (C) 2010 American Megatrends, Inc.
  
```

BIOS Menu 7: Super IO Configuration

5.3.5.1 Serial Port n Configuration

Use the **Serial Port n Configuration** menu (**BIOS Menu 8**) to configure the serial port n.

```

Aptio Setup Utility - Copyright (C) 2010 American Megatrends, Inc.
  Advanced
-----
Serial Port 1 Configuration

Serial Port          [Enabled]
Device Settings      IO=3F8h; IRQ=4

Change Settings      [Auto]

Enable or Disable Serial
Port (COM)

-----
<=>: Select Screen
↑↓: Select Item
EnterSelect
F1  General Help
F2  Previous Values
F3  Optimized Defaults
F4  Save
ESC Exit

Version 2.02.1205. Copyright (C) 2010 American Megatrends, Inc.
  
```

BIOS Menu 8: Serial Port n Configuration Menu

5.3.5.1.1 Serial Port 1 Configuration

→ **Serial Port [Enabled]**

Use the **Serial Port** option to enable or disable the serial port.

- **Disabled** Disable the serial port
- **Enabled** **DEFAULT** Enable the serial port

→ **Change Settings [Auto]**

Use the **Change Settings** option to change the serial port IO port address and interrupt address.

- **Auto** **DEFAULT** The serial port IO port address and interrupt address are automatically detected.
- **IO=3F8h;**
IRQ=4 Serial Port I/O port address is 3F8h and the interrupt address is IRQ4
- **IO=3F8h;**
IRQ=3, 4 Serial Port I/O port address is 3F8h and the interrupt address is IRQ3, 4
- **IO=2F8h;**
IRQ=3, 4 Serial Port I/O port address is 2F8h and the interrupt address is IRQ3, 4

5.3.5.1.2 Serial Port 2 Configuration

→ **Serial Port [Enabled]**

Use the **Serial Port** option to enable or disable the serial port.

- **Disabled** Disable the serial port
- **Enabled** **DEFAULT** Enable the serial port

PPC-5152-D525 Falt-bezel Panel PC

→ Change Settings [Auto]

Use the **Change Settings** option to change the serial port IO port address and interrupt address.

- **Auto** **DEFAULT** The serial port IO port address and interrupt address are automatically detected.
- **IO=2F8h;**
IRQ=3 Serial Port I/O port address is 2F8h and the interrupt address is IRQ3
- **IO=3F8h;**
IRQ=3, 4 Serial Port I/O port address is 3F8h and the interrupt address is IRQ3, 4
- **IO=2F8h;**
IRQ=3, 4 Serial Port I/O port address is 2F8h and the interrupt address is IRQ3, 4

5.3.5.1.3 Serial Port 3 Configuration

→ Serial Port [Enabled]

Use the **Serial Port** option to enable or disable the serial port.

- **Disabled** Disable the serial port
- **Enabled** **DEFAULT** Enable the serial port

→ Change Settings [Auto]

Use the **Change Settings** option to change the serial port IO port address and interrupt address.

- **Auto** **DEFAULT** The serial port IO port address and interrupt address are automatically detected.
- **IO=3E8h;**
IRQ=11 Serial Port I/O port address is 3E8h and the interrupt address is IRQ11

- **IO=3E8h;**
IRQ=10, 11 Serial Port I/O port address is 3E8h and the interrupt address is IRQ10, 11
- **IO=2E8h;**
IRQ=10, 11 Serial Port I/O port address is 2E8h and the interrupt address is IRQ10, 11

→ **Serial Port 3 Mode [RS232]**

Use the **Serial Port 3 Mode** option shows the Serial Port 3 signaling mode is set to RS-232 and can not be changed. The serial port 3 mode is set by the 10-pin DIP switch on the motherboard. Please see **Section 3.11.6.1** for detail.

5.3.5.1.4 Serial Port 4 Configuration

→ **Serial Port [Enabled]**

Use the **Serial Port** option to enable or disable the serial port.

- **Disabled** Disable the serial port
- **Enabled DEFAULT** Enable the serial port

→ **Change Settings [Auto]**

Use the **Change Settings** option to change the serial port IO port address and interrupt address.

- **Auto DEFAULT** The serial port IO port address and interrupt address are automatically detected.
- **IO=2E8h;**
IRQ=10 Serial Port I/O port address is 2E8h and the interrupt address is IRQ10
- **IO=3E8h;**
IRQ=10, 11 Serial Port I/O port address is 3E8h and the interrupt address is IRQ10, 11
- **IO=2E8h;**
IRQ=10, 11 Serial Port I/O port address is 2E8h and the interrupt address is IRQ10, 11

PPC-5152-D525 Falt-bezel Panel PC

→ Serial Port 4 Mode [RS422/485]

The **Serial Port 4 Mode** option shows the Serial Port 4 signaling mode is set to RS-422/485 and can not be changed.

5.3.5.1.5 Serial Port 5 Configuration

→ Serial Port [Enabled]

Use the **Serial Port** option to enable or disable the serial port.

- **Disabled** Disable the serial port
- **Enabled** **DEFAULT** Enable the serial port

→ Change Settings [Auto]

Use the **Change Settings** option to change the serial port IO port address and interrupt address.

- **Auto** **DEFAULT** The serial port IO port address and interrupt address are automatically detected.
- **IO=2E0h;**
IRQ=7 Serial Port I/O port address is 2E0h and the interrupt address is IRQ7
- **IO=3F8h;**
IRQ=3, 4,
5, 6, 7, 10,
11, 12 Serial Port I/O port address is 3F8h and the interrupt address is IRQ3, 4, 5, 6, 7, 10, 11, 12
- **IO=2F8h;**
IRQ=3, 4,
5, 6, 7, 10,
11, 12 Serial Port I/O port address is 2F8h and the interrupt address is IRQ3, 4, 5, 6, 7, 10, 11, 12

- **IO=3E8h;** Serial Port I/O port address is 3E8h and the interrupt address is IRQ3, 4, 5, 6, 7, 10, 11, 12

IRQ=3, 4,

5, 6, 7, 10,

11, 12
- **IO=2E8h;** Serial Port I/O port address is 2E8h and the interrupt address is IRQ3, 4, 5, 6, 7, 10, 11, 12

IRQ=3, 4,

5, 6, 7, 10,

11, 12
- **IO=2E0h;** Serial Port I/O port address is 2E0h and the interrupt address is IRQ3, 4, 5, 6, 7, 10, 11, 12

IRQ=3, 4,

5, 6, 7, 10,

11, 12

→ **Serial Port 5 Mode [RS422/485]**

The **Serial Port 5 Mode** option is set the Serial Port 5 signaling mode to RS-422/485 and can not be changed.

5.3.5.1.6 Serial Port 6 Configuration

→ **Serial Port [Enabled]**

Use the **Serial Port** option to enable or disable the serial port.

- **Disabled** Disable the serial port
- **Enabled DEFAULT** Enable the serial port

→ **Change Settings [Auto]**

Use the **Change Settings** option to change the serial port IO port address and interrupt address.

- **Auto DEFAULT** The serial port IO port address and interrupt address are automatically detected.

PPC-5152-D525 Falt-bezel Panel PC

➔	IO=2E0h; IRQ=10	Serial Port I/O port address is 2E0h and the interrupt address is IRQ10
➔	IO=2C0h; IRQ=10, 11	Serial Port I/O port address is 2C0h and the interrupt address is IRQ10, 11
➔	IO=2C8h; IRQ=10, 11	Serial Port I/O port address is 2C8h and the interrupt address is IRQ10, 11
➔	IO=2D0h; IRQ=10, 11	Serial Port I/O port address is 2D0h and the interrupt address is IRQ10, 11
➔	IO=2D8h; IRQ=10, 11	Serial Port I/O port address is 2D8h and the interrupt address is IRQ10, 11
➔	IO=2E0h; IRQ=10, 11	Serial Port I/O port address is 2E0h and the interrupt address is IRQ10, 11

5.3.6 H/W Monitor

The H/W Monitor menu (**BIOS Menu 9**) shows the operating temperature, fan speeds and system voltages.

```

Aptio Setup Utility - Copyright (C) 2010 American Megatrends, Inc.
  Advanced

PC Health Status

CPU Temperature           :+63 C
SYS Temperature          :+39 C
CPU FAN Speed            :N/A
VCC3C                    :+3.296 V
V_core                   :+1.024 V
Vcc                      :+5.045 V
Vcc12                    :+11.934 V
Vcc1_5VDDR               :+1.552 V
VSB3V                    :+3.328 V
VBAT                     :+3.200 V

-----
<->: Select Screen
↑ ↓: Select Item
Enter>Select
F1   General Help
F2   Previous Values
F3   Optimized Defaults
F4   Save
ESC  Exit

Version 2.02.1205. Copyright (C) 2010 American Megatrends, Inc.
  
```

BIOS Menu 9: Hardware Health Configuration

→ PC Health Status

The following system parameters and values are shown. The system parameters that are monitored are:

- System Temperatures:
 - CPU Temperature
 - System Temperature
- Voltages:
 - VCC3V
 - V_core
 - Vcc
 - Vcc12
 - Vcc1_5VDDR
 - VSB3V
 - VBAT

5.3.7 Serial Port Console Redirection

The **Serial Port Console Redirection** menu (**BIOS Menu 10**) allows the console redirection options to be configured. Console redirection allows users to maintain a system remotely by re-directing keyboard input and text output through the serial port.

PPC-5152-D525 Falt-bezel Panel PC

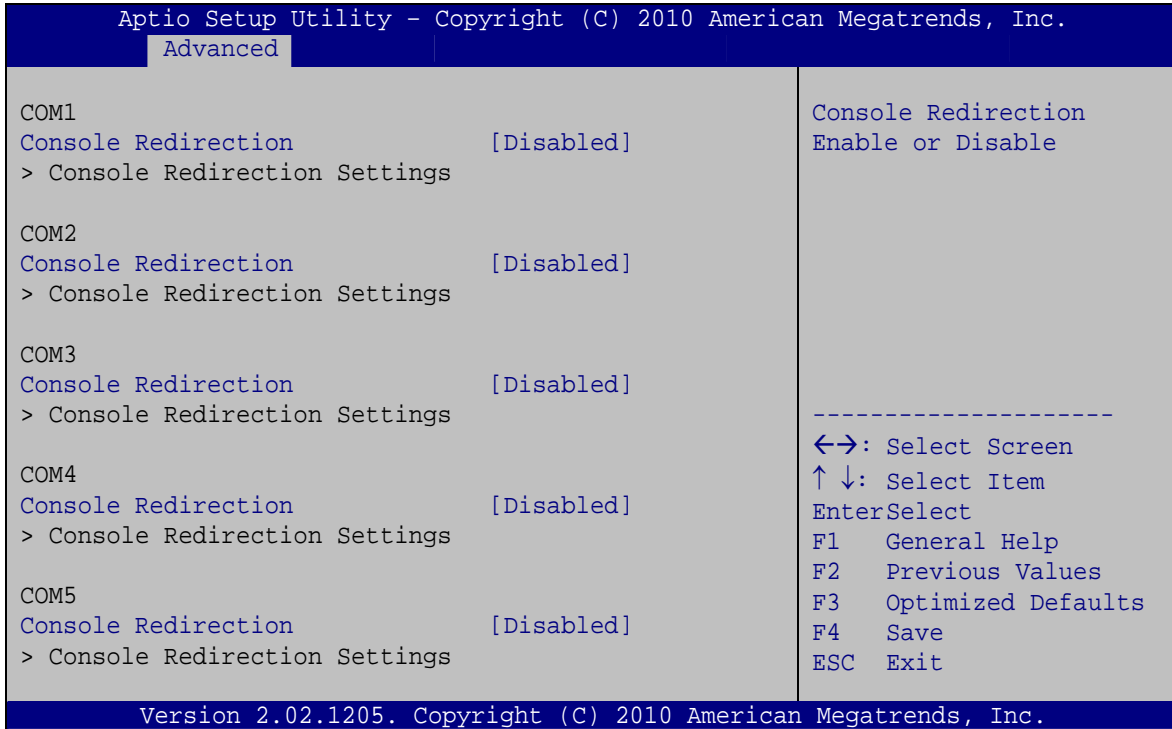

BIOS Menu 10: Serial Port Console Redirection

→ Console Redirection [Disabled]

Use **Console Redirection** option to enable or disable the console redirection function.

- **Disabled** **DEFAULT** Disabled the console redirection function
- **Enabled** Enabled the console redirection function

5.3.7.1 Console Redirection Settings

Use the **Console Redirection Settings** menu (**BIOS Menu 11**) to configure console redirection settings of the specified serial port. This menu appears only when the Console Redirection is enabled.

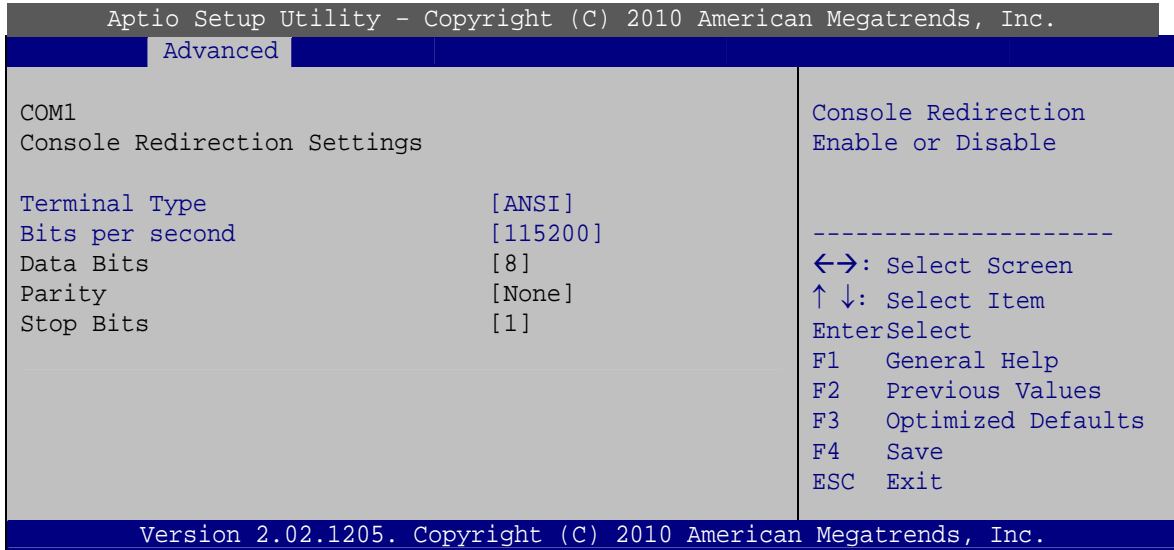

BIOS Menu 11: Console Redirection Settings

➔ **Terminal Type [ANSI]**

Use the **Terminal Type** option to specify the remote terminal type.

- ➔ **VT100** The target terminal type is VT100
- ➔ **VT100+** The target terminal type is VT100+
- ➔ **VT-UTF8** The target terminal type is VT-UTF8
- ➔ **ANSI DEFAULT** The target terminal type is ANSI

➔ **Bits per second [115200]**

Use the **Bits per second** option to select serial port transmission speed. The speed must match on the other side. Long or noisy lines may require lower speeds. The options include:

- 9600
- 19200
- 57600
- 115200 **DEFAULT**

PPC-5152-D525 Falt-bezel Panel PC

5.3.8 IEI Feature

Use the **IEI Feature** menu (**BIOS Menu 12**) to configure One Key Recovery function.

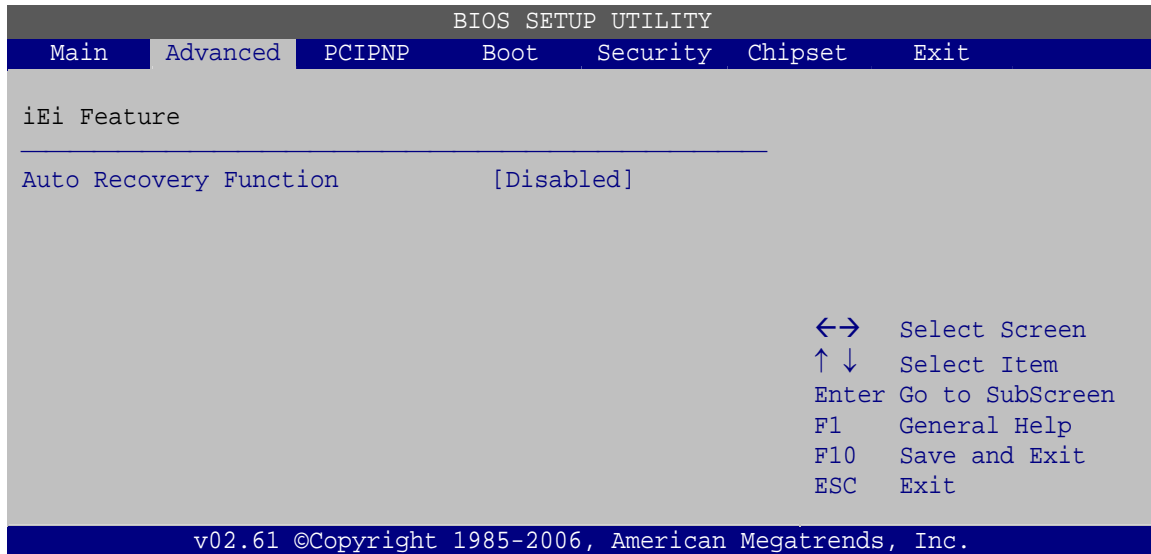

BIOS Menu 12: IEI Feature

→ Auto Recovery Function [Disabled]

Use the **Auto Recovery Function** BIOS option to enable or disable the auto recovery function of the IEI One Key Recovery.

- **Disabled** **DEFAULT** Auto recovery function disabled
- **Enabled** Auto recovery function enabled

5.4 Chipset

Use the **Chipset** menu (**BIOS Menu 13**) to access the Northbridge and Southbridge configuration menus



WARNING!

Setting the wrong values for the Chipset BIOS selections in the Chipset BIOS menu may cause the system to malfunction.

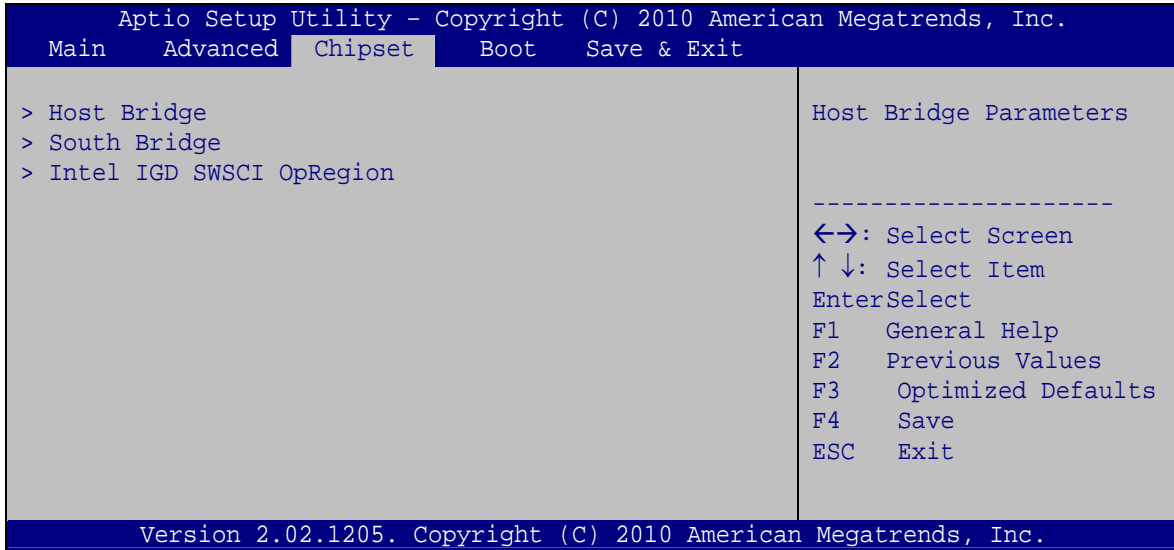

BIOS Menu 13: Chipset

5.4.1 Host Bridge Configuration

Use the **Host Bridge Configuration** menu (**BIOS Menu 14**) to configure the Northbridge chipset.

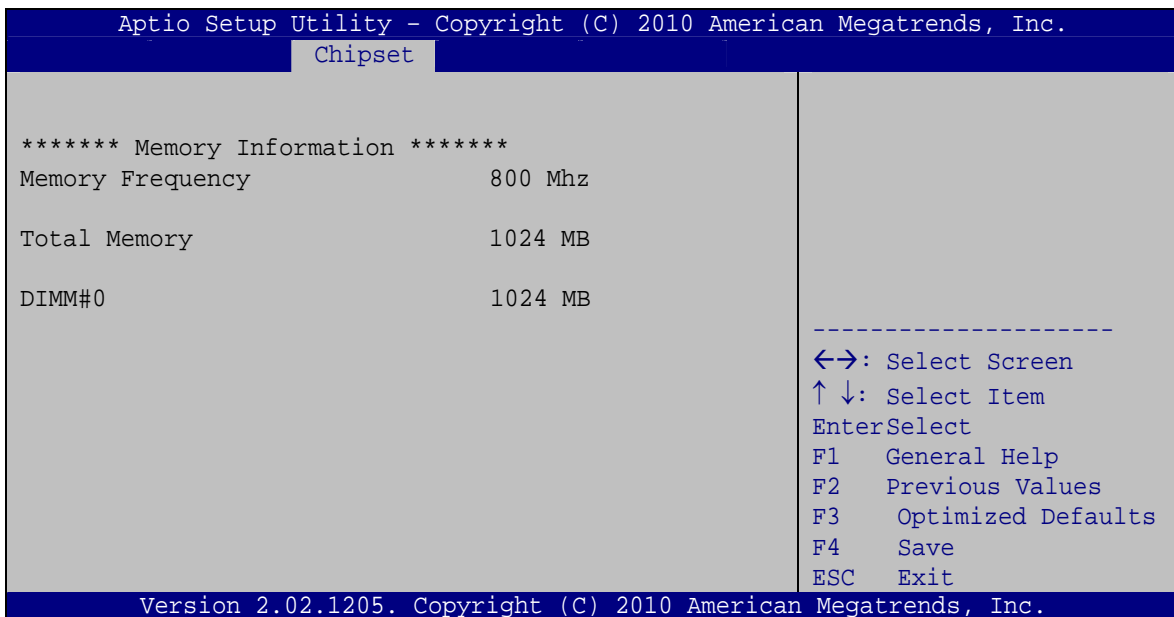

BIOS Menu 14: Host Bridge Chipset Configuration

PPC-5152-D525 Falt-bezel Panel PC

5.4.2 South Bridge Configuration

Use the **South Bbridge Configuration** menu (**BIOS Menu 15**) to configure the Southbridge chipset.

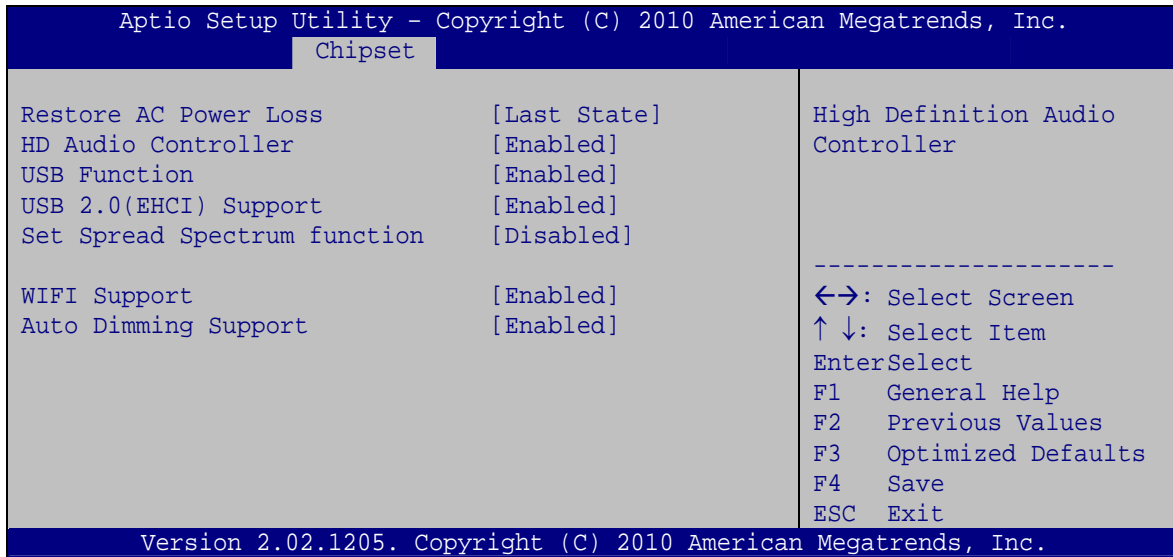

BIOS Menu 15: South Bridge Chipset Configuration

→ Restore on AC Power Loss [Last State]

Use the **Restore on AC Power Loss** BIOS option to specify what state the system returns to if there is a sudden loss of power to the system.

- **Power Off** The system remains turned off
- **Power On** The system turns on
- **Last State** **DEFAULT** The system returns to its previous state. If it was on, it turns itself on. If it was off, it remains off.

→ HD Audio Controller [Enabled]

The **HD Audio Controller** option enables or disables the HD Audio controller.

- **Enabled** **DEFAULT** The onboard HD Audio controller is enabled
- **Disabled** The onboard HD Audio controller is disabled

→ **USB Function [Enabled]**

Use the **USB Function** BIOS option to enable or disable USB function support.

- **Disabled** USB function support disabled
- **Enabled** **DEFAULT** USB function support enabled

→ **USB 2.0 (EHCI) Support [Enabled]**

This is a workaround for system without EHCI hand-off support. The EHCI is a high speed controller standard.

- **Enabled** **DEFAULT** USB 2.0 (EHCI) support enabled
- **Disabled** USB 2.0 (EHCI) support disabled

→ **Set Spread Spectrum function [Disabled]**

Use the **Set Spread Spectrum function** option to reduce the EMI. Excess EMI is generated when the system clock generator pulses have extreme values. Spreading the pulse spectrum modulates changes in the extreme values from spikes to flat curves, thus reducing the EMI. This benefit may in some cases be outweighed by problems with timing-critical devices, such as a clock-sensitive SCSI device.

- **Disabled** **DEFAULT** EMI not reduced
- **Enabled** EMI reduced

→ **WIFI Support [Enabled]**

Use the **WIFI Support** option to enable or disable the Wi-Fi function.

- **Enabled** **DEFAULT** Enables Wi-Fi function
- **Disabled** Disables Wi-Fi function

→ **Auto Dimming Support [Enabled]**

Use the **Auto Dimming Support** option to enable or disable the auto dimming function.

PPC-5152-D525 Falt-bezel Panel PC

- ➔ **Enabled** **DEFAULT** Enables auto dimming function
- ➔ **Disabled** Disables auto dimming function

5.4.3 Intel IGD SWSCI OpRegion

Use the **Intel IGD SWSCI OpRegion** menu (**BIOS Menu 16**) to configure the video device connected to the system.

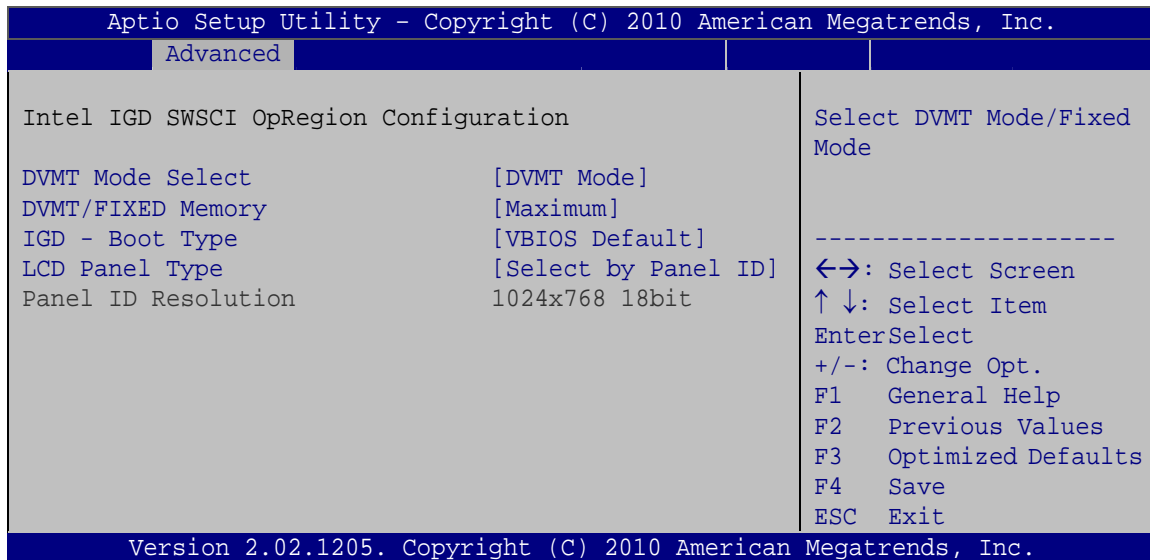

BIOS Menu 16: Intel IGD SWSCI OpRegion

➔ **DVT Mode Select [DVT Mode]**

Use the **DVT Mode Select** option to select the Intel Dynamic Video Memory Technology (DVT) operating mode.

- ➔ **Fixed Mode** A fixed portion of graphics memory is reserved as graphics memory.
- ➔ **DVT Mode** **DEFAULT** Graphics memory is dynamically allocated according to the system and graphics needs.

➔ **DVT/FIXED Memory [Maximum]**

Use the **DVT/FIXED Memory** option to specify the maximum amount of memory that can be allocated as graphics memory. Configuration options are listed below.

- 128 MB
- 256 MB
- Maximum **Default**

→ **IGD - Boot Type [VBIOS Default]**

Use the **IGD - Boot Type** option to select the display device used by the system when it boots. Configuration options are listed below.

- VBIOS Default **DEFAULT**
- CRT
- LFP
- CRT + LFP

→ **LCD Panel Type [1024x768 18bit]**

Use the **LCD Panel Type** option to select the type of flat panel connected to the system. Configuration options are listed below.

- 640x480 18bit
- 800x480 18bit
- 800x600 18bit
- 1024x768 18bit **DEFAULT**
- 1280x1024 18bit
- 1366x768 18bit
- 1280x800 18bit
- 1280x600 18bit

PPC-5152-D525 Falt-bezel Panel PC

5.5 Boot

Use the **Boot** menu (**BIOS Menu 17**) to configure system boot options.

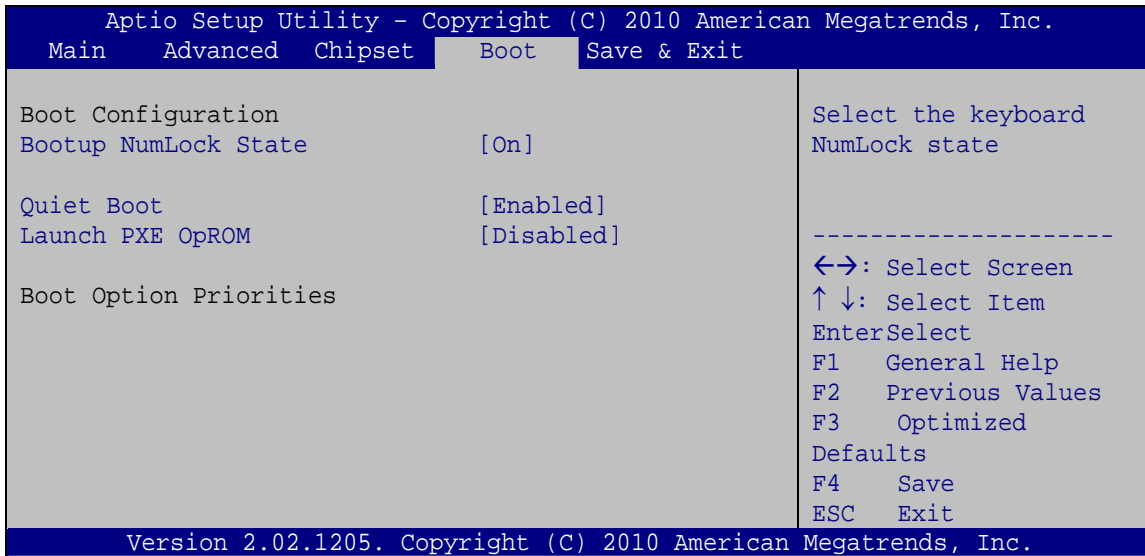

BIOS Menu 17: Boot

→ Bootup NumLock State [On]

Use the **Bootup NumLock State** BIOS option to specify if the number lock setting must be modified during boot up.

- **On** **DEFAULT** Allows the Number Lock on the keyboard to be enabled automatically when the computer system boots up. This allows the immediate use of the 10-key numeric keypad located on the right side of the keyboard. To confirm this, the Number Lock LED light on the keyboard is lit.
- **Off** Does not enable the keyboard Number Lock automatically. To use the 10-keys on the keyboard, press the Number Lock key located on the upper left-hand corner of the 10-key pad. The Number Lock LED on the keyboard lights up when the Number Lock is engaged.

→ **Quiet Boot [Enabled]**

Use the **Quiet Boot** BIOS option to select the screen display when the system boots.

- **Disabled** Normal POST messages displayed
- **Enabled** **DEFAULT** OEM Logo displayed instead of POST messages

→ **Launch PXE OpROM [Disabled]**

Use the **Launch PXE OpROM** option to enable or disable boot option for legacy network devices.

- **Disabled** **DEFAULT** Ignore all PXE Option ROMs
- **Enabled** Load PXE Option ROMs

5.6 Save & Exit

Use the **Save & Exit** menu (**BIOS Menu 18**) to load default BIOS values, optimal failsafe values and to save configuration changes.

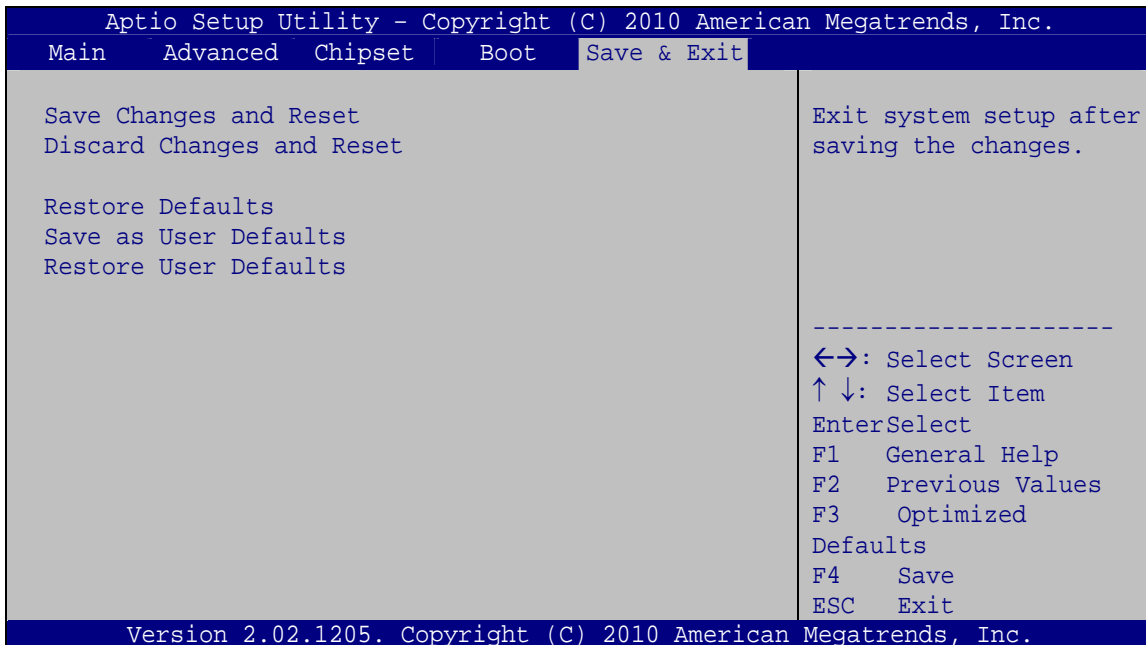

BIOS Menu 18: Save & Exit

PPC-5152-D525 Falt-bezel Panel PC

→ **Save Changes and Reset**

Use the **Save Changes and Reset** option to save the changes made to the BIOS options and reset the system.

→ **Discard Changes and Reset**

Use the **Discard Changes and Reset** option to exit the system without saving the changes made to the BIOS configuration setup program.

→ **Restore Defaults**

Use the **Restore Defaults** option to load the optimal default values for each of the parameters on the Setup menus. **F3 key can be used for this operation.**

→ **Save as User Defaults**

Use the **Save as User Defaults** option to save the changes done so far as user defaults.

→ **Restore User Defaults**

Use the **Restore User Defaults** option to restore the user defaults to all the setup options.

Chapter

6

Software Drivers

PPC-5152-D525 Falt-bezel Panel PC

6.1 Available Software Drivers



NOTE:

The content of the CD may vary throughout the life cycle of the product and is subject to change without prior notice. Visit the IEI website or contact technical support for the latest updates.

The following drivers can be installed on the system:

- Chipset
- Graphic
- LAN
- Audio
- Touch Screen
- USB 3.0

Installation instructions are given below.

6.2 Starting the Driver Program

To access the driver installation programs, please do the following.

Step 1: Insert the CD-ROM that came with the system into a CD-ROM drive attached to the system.

Step 2: Click **PPC-5152-D525**.

Step 3: A list of available drivers appears.

6.3 Chipset Driver Installation

To install the chipset driver, please do the following.

Step 1: Access the driver list. (See **Section 6.2**)

Step 2: Click "**Chipset**" and select the folder which corresponds to the operating system.

Step 3: Locate the setup file and double click on it.

Step 4: The setup files are extracted as shown in **Figure 6-1**.



Figure 6-1: Chipset Driver Screen

Step 5: When the setup files are completely extracted the **Welcome Screen** in **Figure 6-2** appears.

Step 6: Click **Next** to continue.

PPC-5152-D525 Falt-bezel Panel PC



Figure 6-2: Chipset Driver Welcome Screen

Step 7: The license agreement in Figure 6-3 appears.

Step 8: Read the License Agreement.

Step 9: Click Yes to continue.



Figure 6-3: Chipset Driver License Agreement

Step 10: The Read Me file in Figure 6-4 appears.

Step 11: Click **Next** to continue.



Figure 6-4: Chipset Driver Read Me File

Step 12: **Setup Operations** are performed as shown in **Figure 6-5**.

Step 13: Once the **Setup Operations** are complete, click **Next** to continue.



Figure 6-5: Chipset Driver Setup Operations

PPC-5152-D525 Falt-bezel Panel PC

Step 14: The **Finish** screen in **Figure 6-6** appears.

Step 15: Select “**Yes, I want to restart this computer now**” and click **Finish**.



Figure 6-6: Chipset Driver Installation Finish Screen

6.4 Graphics Driver Installation

To install the Graphics driver, please do the following.

Step 1: Access the driver list. (See **Section 6.2**)

Step 2: Click “**Graphic**” and select the folder which corresponds to the operating system.

Step 3: Double click the setup file.

Step 4: The **Read Me** file in **Figure 6-7** appears.

Step 5: Click **Next** to continue.

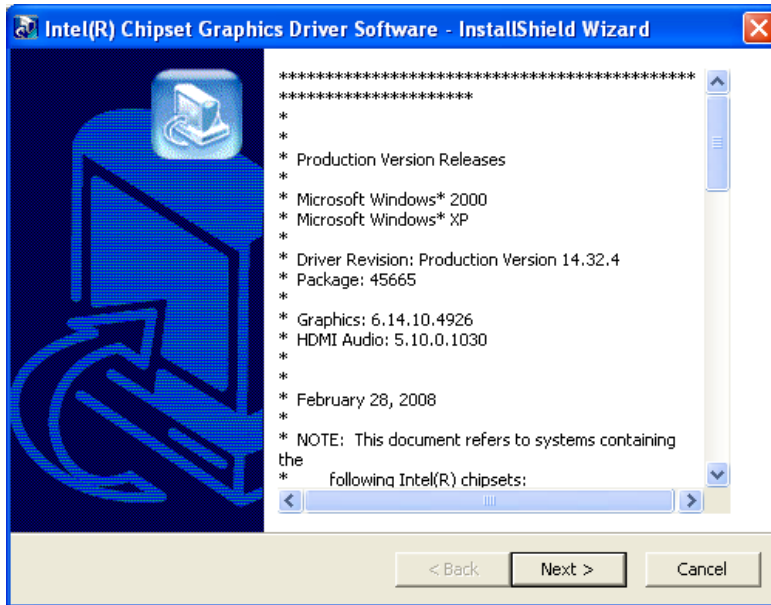

Figure 6-7: Graphics Driver Read Me File

Step 6: The installation files are extracted. See **Figure 6-8**.

Step 7: Click **Next** to continue.

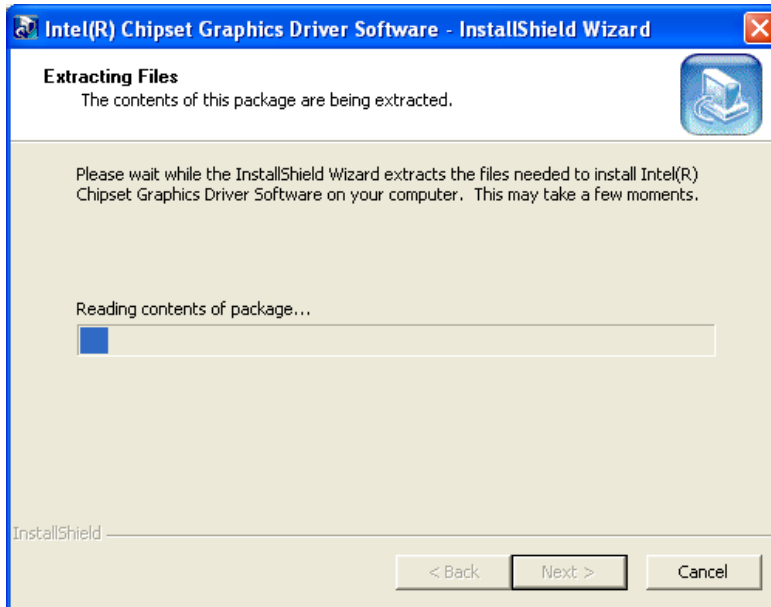

Figure 6-8: Graphics Driver Setup Files Extracted

Step 8: The **Welcome Screen** in **Figure 6-9** appears.

Step 9: Click **Next** to continue.

PPC-5152-D525 Falt-bezel Panel PC



Figure 6-9: Graphics Driver Welcome Screen

Step 10: The License Agreement in Figure 6-10 appears.

Step 11: Click **Yes** to accept the agreement and continue.

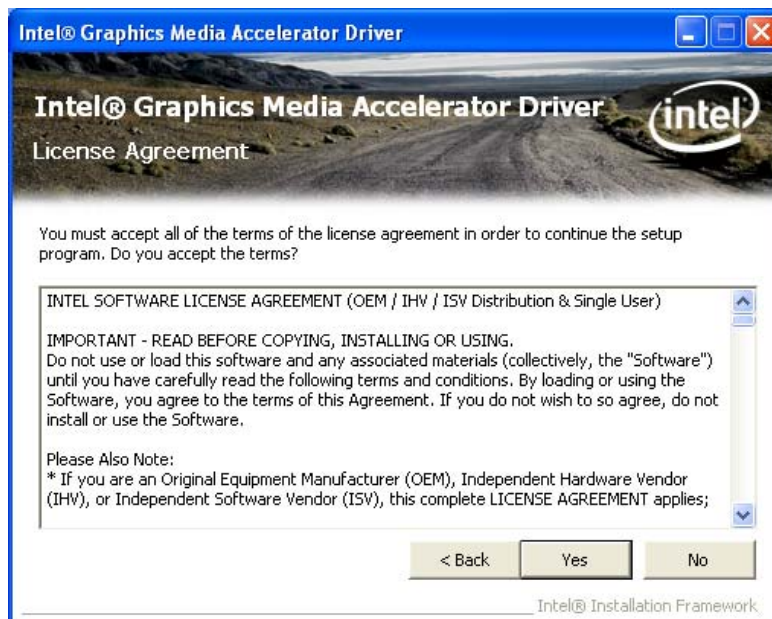

Figure 6-10: Graphics Driver License Agreement

Step 12: The Read Me file in Figure 6-11 appears.

Step 13: Click **Next** to continue.

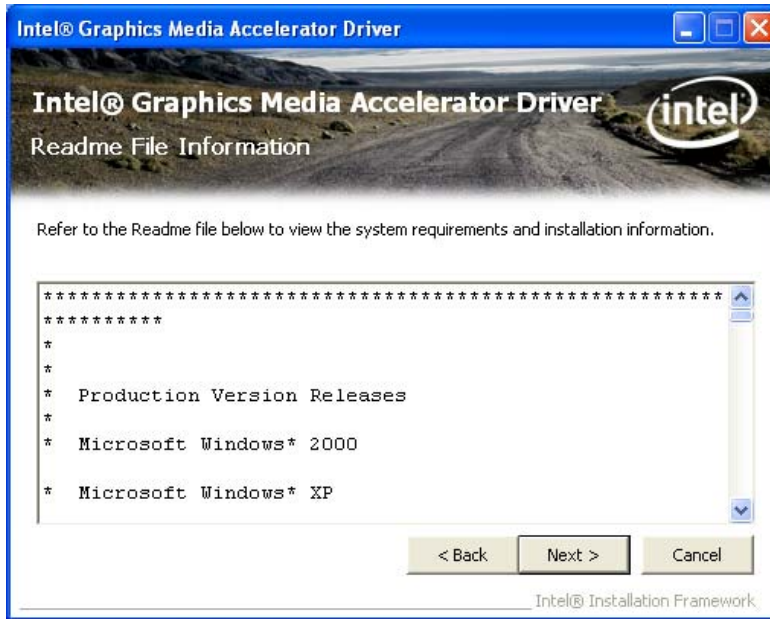

Figure 6-11: Graphics Driver Read Me File

Step 14: Setup Operations are performed as shown in Figure 6-12.

Step 15: Once the Setup Operations are complete, click **Next** to continue.

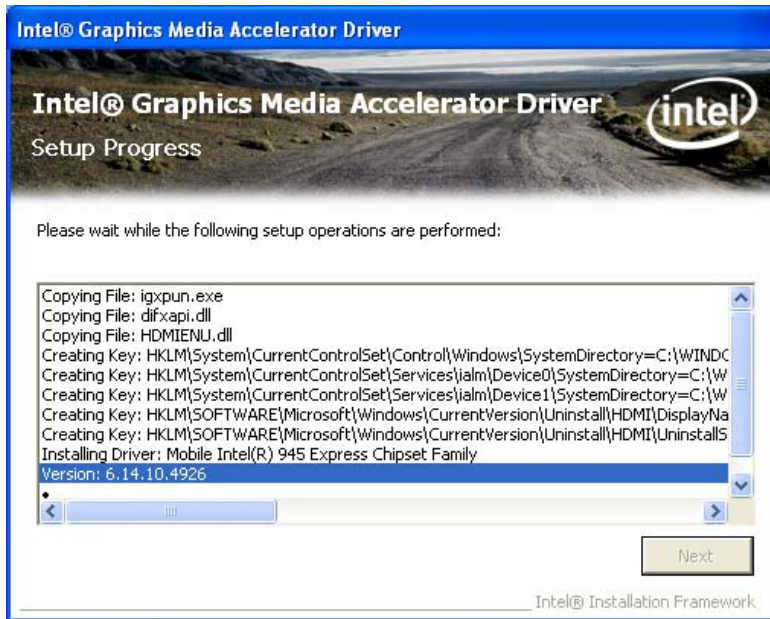

Figure 6-12: Graphics Driver Setup Operations

Step 16: The Finish screen in Figure 6-13 appears.

Step 17: Select “Yes, I want to restart this computer now” and click **Finish**.



Figure 6-13: Graphics Driver Installation Finish Screen

6.5 LAN Driver Installation

To install the LAN driver, please do the following.

- Step 1:** Access the driver list. (See **Section 6.2**)
- Step 2:** Click “LAN” and select the **Realtek** folder
- Step 3:** Select the folder which corresponds to the operating system.
- Step 4:** Double click the setup file.
- Step 5:** The **Welcome** screen in **Figure 6-14** appears.

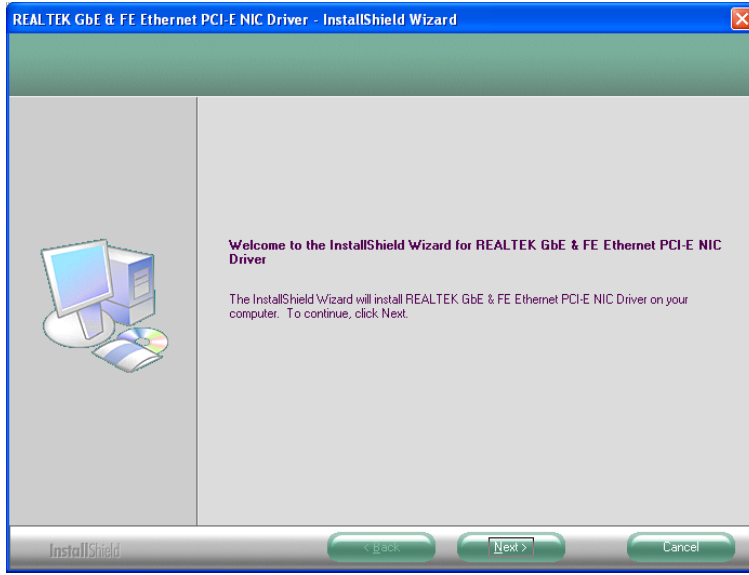

Figure 6-14: LAN Driver Welcome Screen

Step 6: Click **Next** to continue.

Step 7: The **Ready to Install** screen in **Figure 6-15** appears.

Step 8: Click **Next** to proceed with the installation.

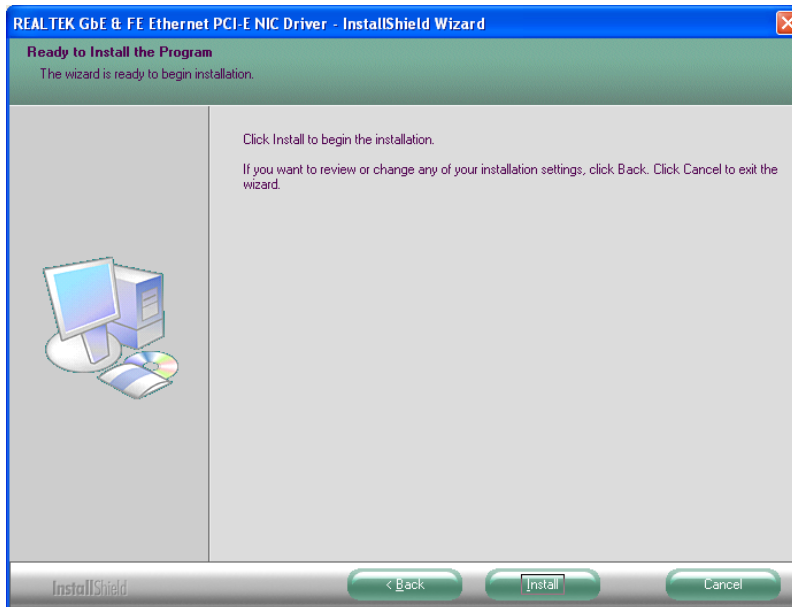

Figure 6-15: LAN Driver Welcome Screen

Step 9: The program begins to install.

PPC-5152-D525 Flat-bezel Panel PC

Step 10: The installation progress can be monitored in the progress bar shown in **Figure 6-16**.

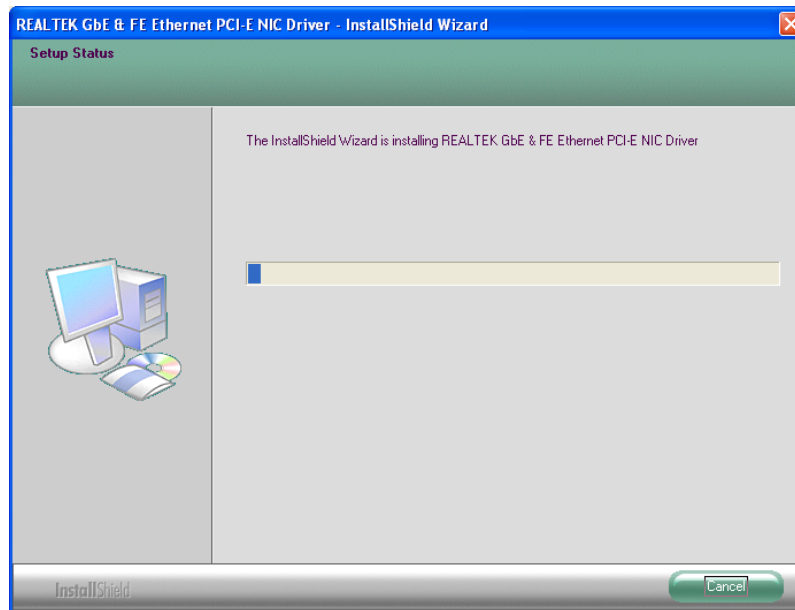

Figure 6-16: LAN Driver Installation

Step 11: When the driver installation is complete, the screen in **Figure 6-17** appears.

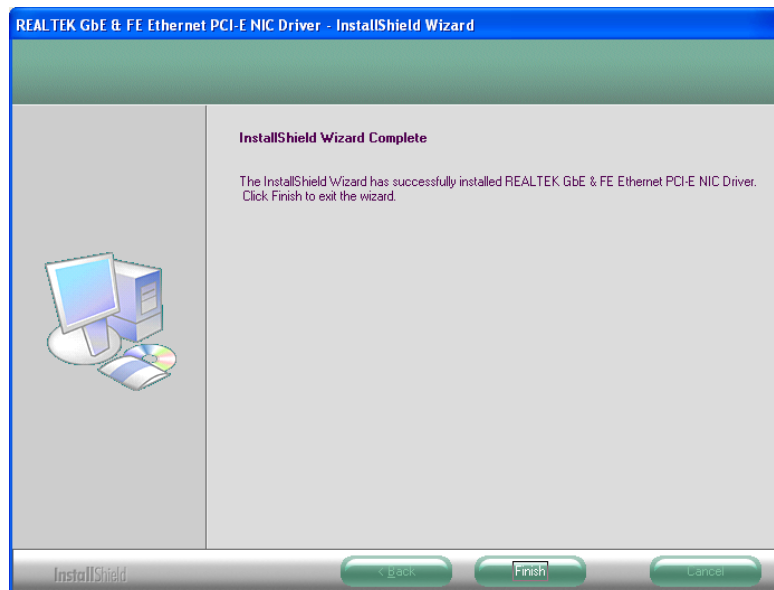

Figure 6-17: LAN Driver Installation Complete

6.6 Audio Driver Installation

To install the audio driver, please do the following.

Step 1: Access the driver list. (See **Section 6.2**)

Step 2: Click “**Audio**”.

Step 3: Double click the setup file.

Step 4: The **Audio Driver Welcome Screen** in **Figure 6-18** appears.

Step 5: Click **Next** to continue.

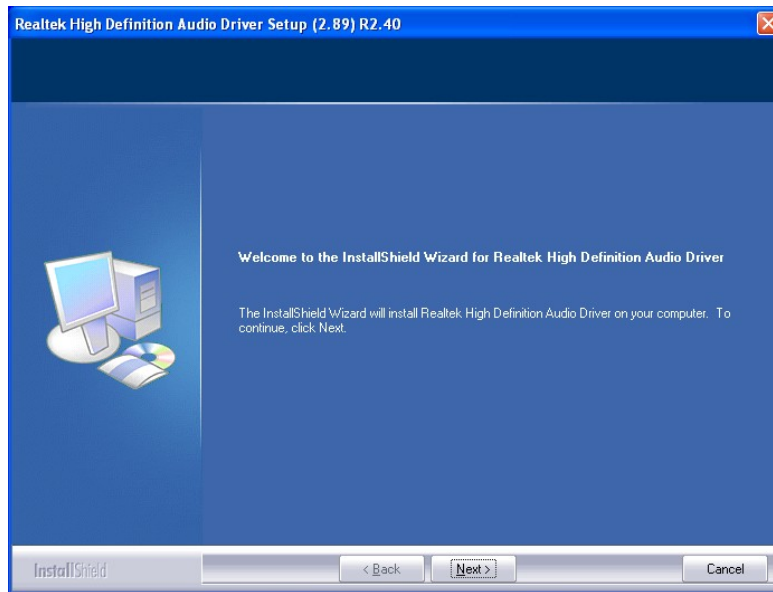

Figure 6-18: Audio Driver Welcome Screen

Step 6: The audio driver installation begins. See **Figure 6-19**.

PPC-5152-D525 Flat-bezel Panel PC

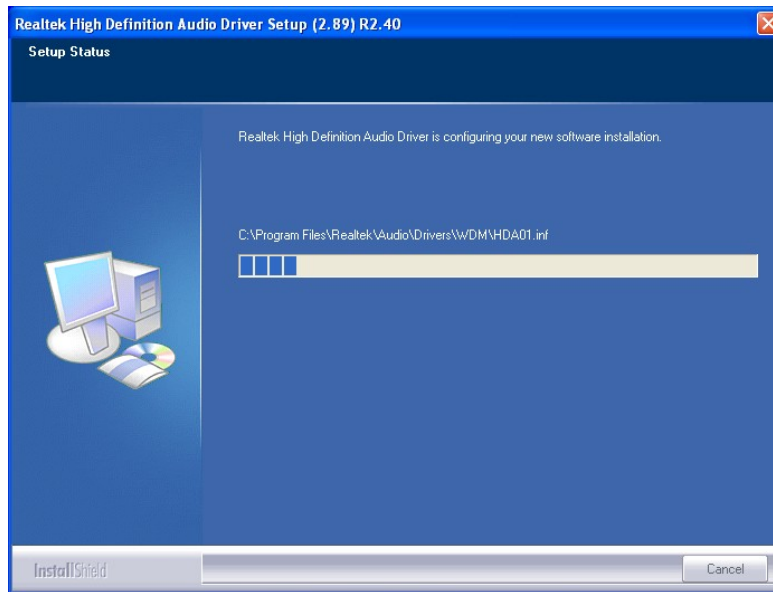

Figure 6-19: Audio Driver Installation

Step 7: When the installation is complete, the screen in **Figure 6-20** appears.

Step 8: Select “Yes, I want to restart my computer now” and click **Finish**.

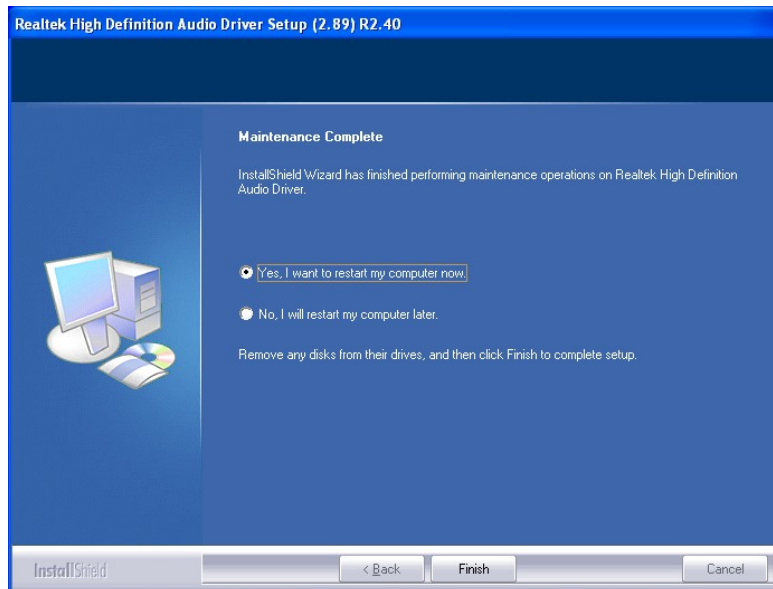

Figure 6-20: AC'97 Driver Installation Complete

6.7 Touch Screen Driver Installation

To install the touch panel software driver, please follow the steps below.

Step 1: Access the driver list. (See **Section 6.2**)

Step 2: Click “**Touch Screen.**”

Step 3: Locate the setup file and double click on it.

Step 4: A **Welcome Screen** appears (**Figure 6-21**).

Step 5: Click **NEXT** to continue.

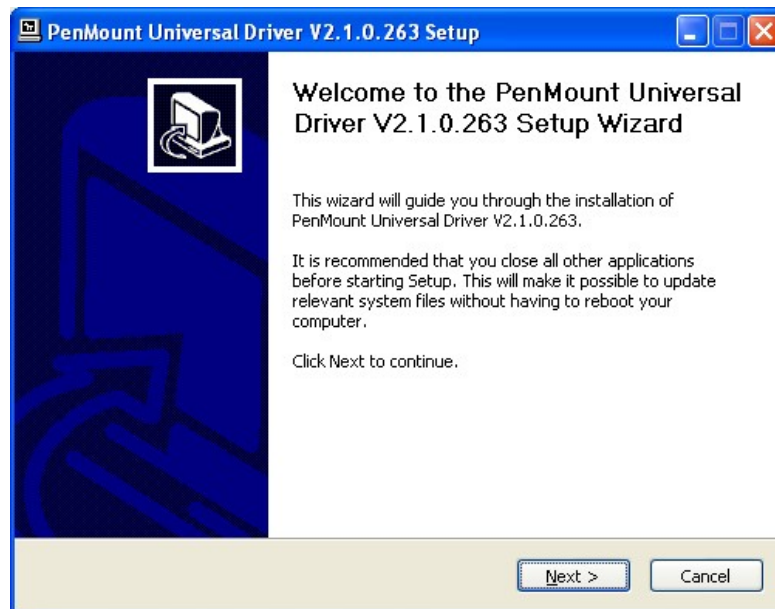

Figure 6-21: Touch Screen Driver Welcome Screen

Step 6: The **License Agreement** shown in **Figure 6-22** appears.

Step 7: Click **I AGREE** to accept and continue.

PPC-5152-D525 Falt-bezel Panel PC

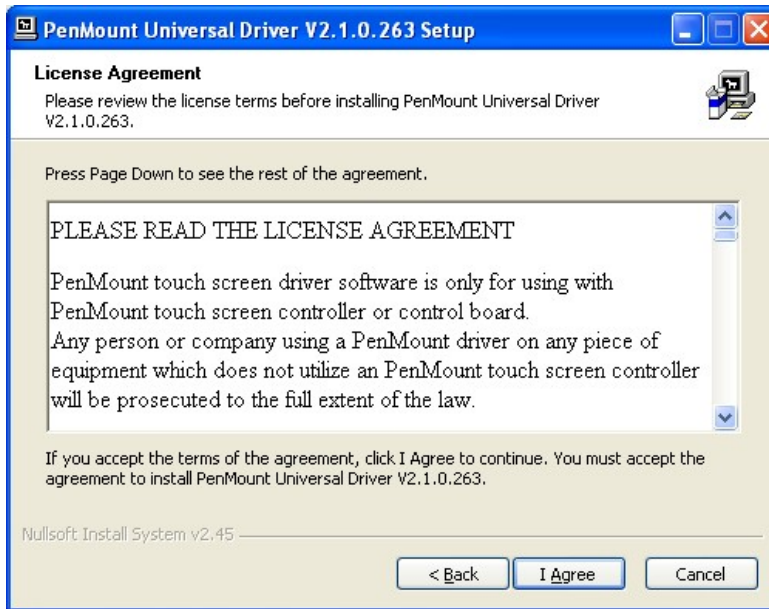

Figure 6-22: Touch Screen Driver License Agreement

Step 8: Browse for an install location or use the one suggested (Figure 6-23).

Step 9: Click **INSTALL** to continue.

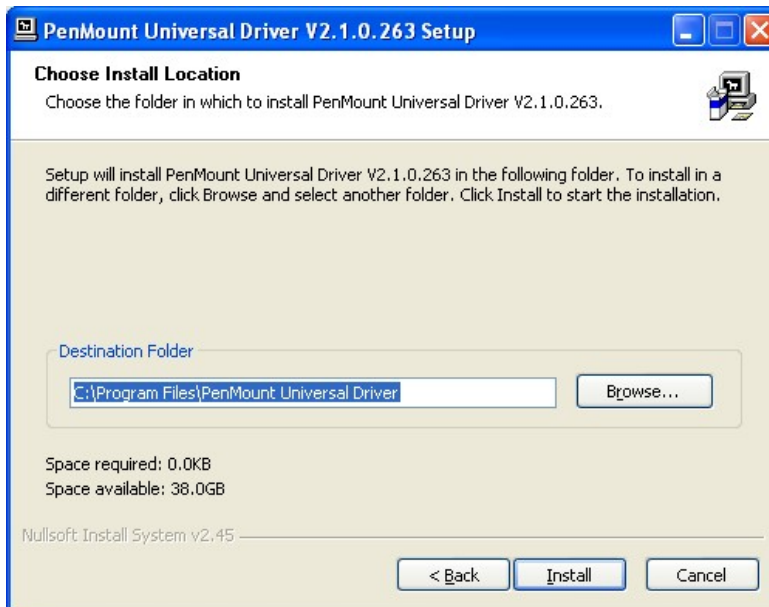

Figure 6-23: Touch Screen Driver Choose Install Location

Step 10: The **Install** screen appears and displays the progress of the installation (Figure 6-24).

Step 11: Click **NEXT** to continue.

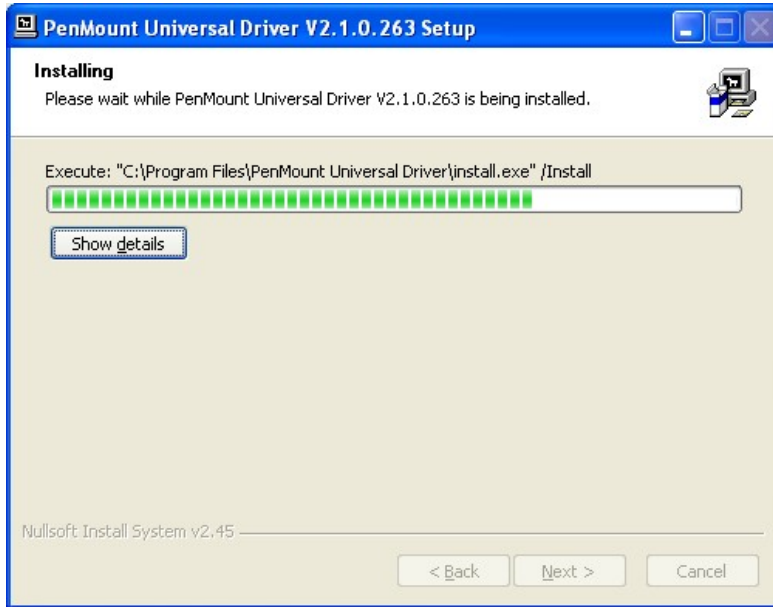

Figure 6-24: Touch Screen Driver Installation Screen

Step 12: When the installation is complete, click **FINISH** to exit setup. (Figure 6-25).

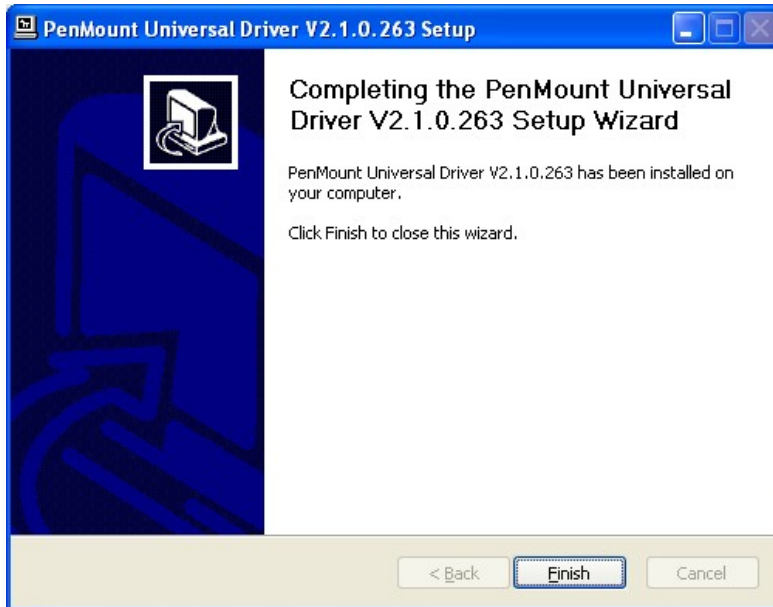

Figure 6-25: Touch Screen Driver Update Complete

PPC-5152-D525 Falt-bezel Panel PC

6.7.1 Calibrating the Touch Screen

To calibrate the touch screen cursor with the motion of the touch screen pen (or finger), please follow the steps below:

Step 1: Make sure the touch screen driver is properly installed.

Step 2: Locate the PenMount Monitor icon in the bottom right corner of the screen.



Figure 6-26: PenMount Monitor Icon

Step 3: Click the icon. A pop up menu appears. See **Figure 6-27**.

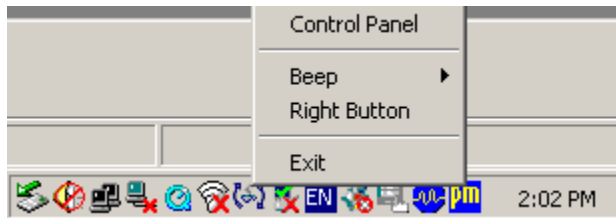

Figure 6-27: PenMount Monitor Popup Menu

Step 4: Click Control Panel in the pop up menu shown in **Figure 6-27**.

Step 5: The configuration screen in **Figure 6-28** appears.

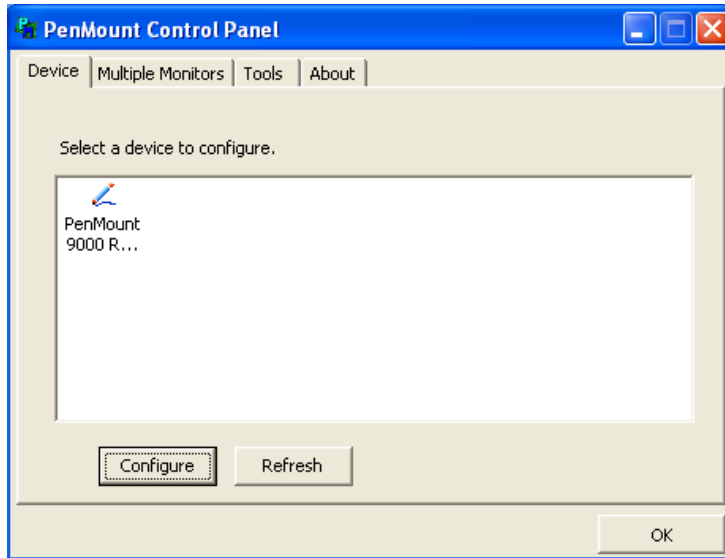

Figure 6-28: Configuration Screen

Step 6: Double click the PenMount 9000 icon as shown in **Figure 6-28**.

Step 7: The calibration initiation screen in **Figure 6-29** appears.

Step 8: Select the **Standard Calibration** button as shown in **Figure 6-29**.

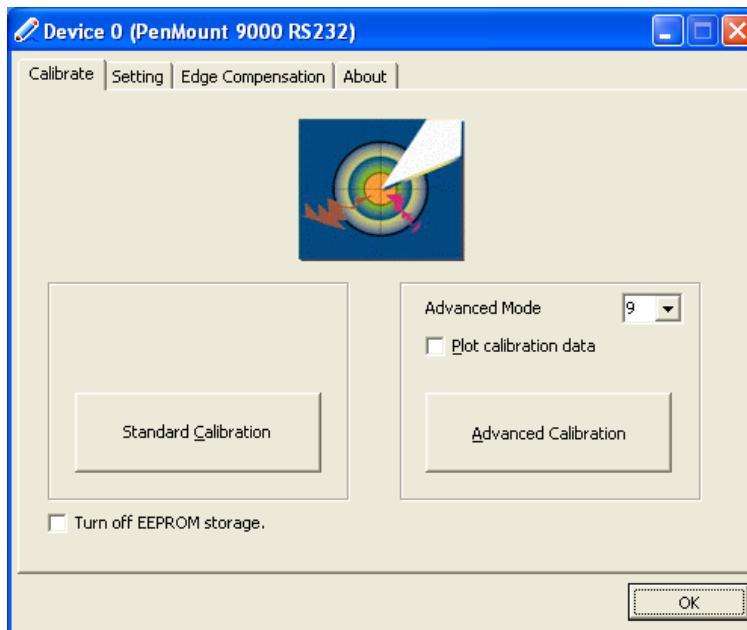

Figure 6-29: Calibration Initiation Screen

Step 9: The calibration screen in is shown. See **Figure 6-30**.

PPC-5152-D525 Falt-bezel Panel PC

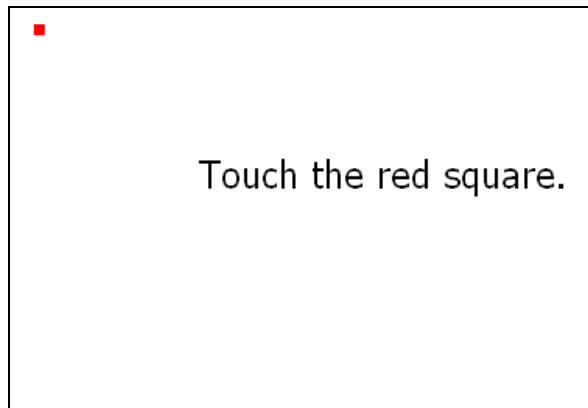

Figure 6-30: Calibration Screen

Step 10: Follow the instructions. The user is asked touch the screen at five specified points after which the screen is calibrated.

6.8 USB 3.0 Driver Installation

To install the USB 3.0 driver, please follow the steps below.

Step 1: Access the driver list. (See **Section 6.2**)

Step 2: Click “**USB 3.0**”.

Step 3: Locate the setup file and double click on it.

Step 4: A **Welcome Screen** appears (**Figure 6-31**).

Step 5: Click **NEXT** to continue.

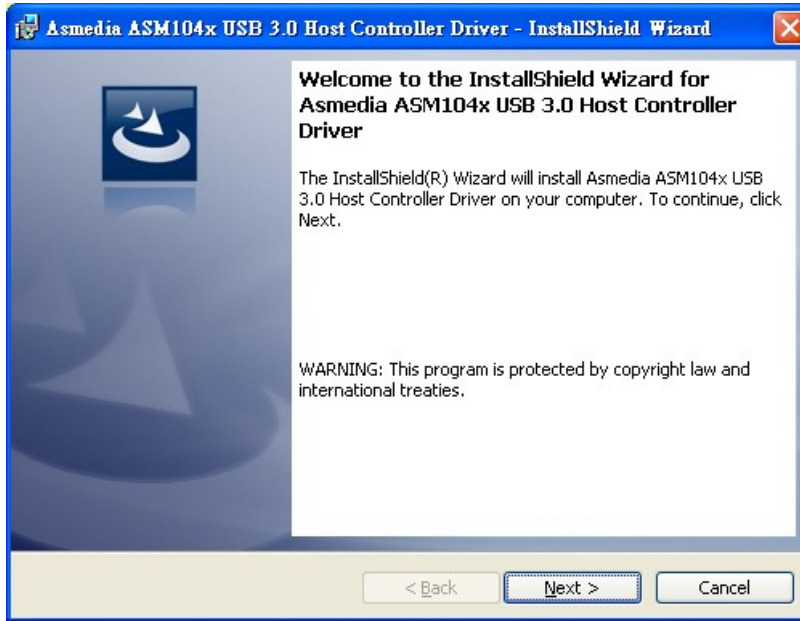

Figure 6-31: USB 3.0 Driver Welcome Screen

Step 6: The License Agreement shown in Figure 6-32 appears.

Step 7: Click “I accept the terms in the license agreement” to accept and continue.

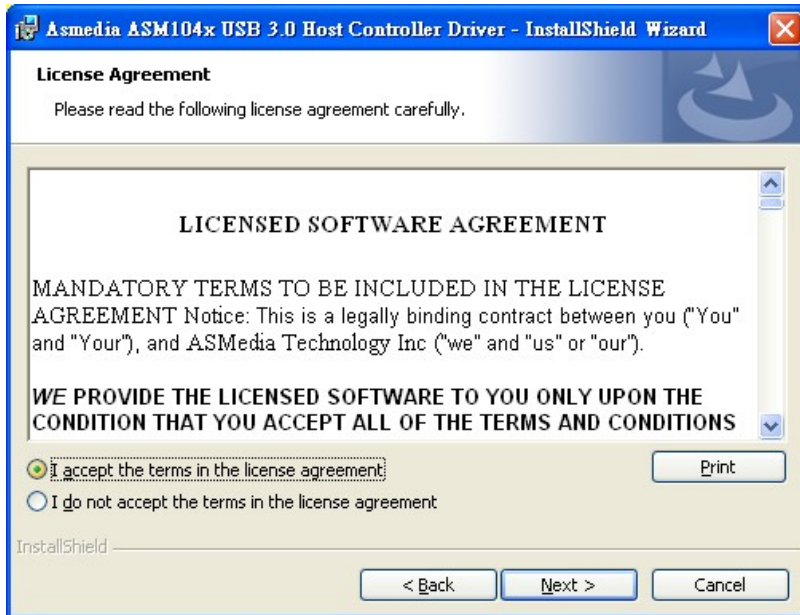

Figure 6-32: USB 3.0 Driver License Agreement

Step 8: The Install screen appears and displays the progress of the installation (Figure 6-33).

PPC-5152-D525 Falt-bezel Panel PC

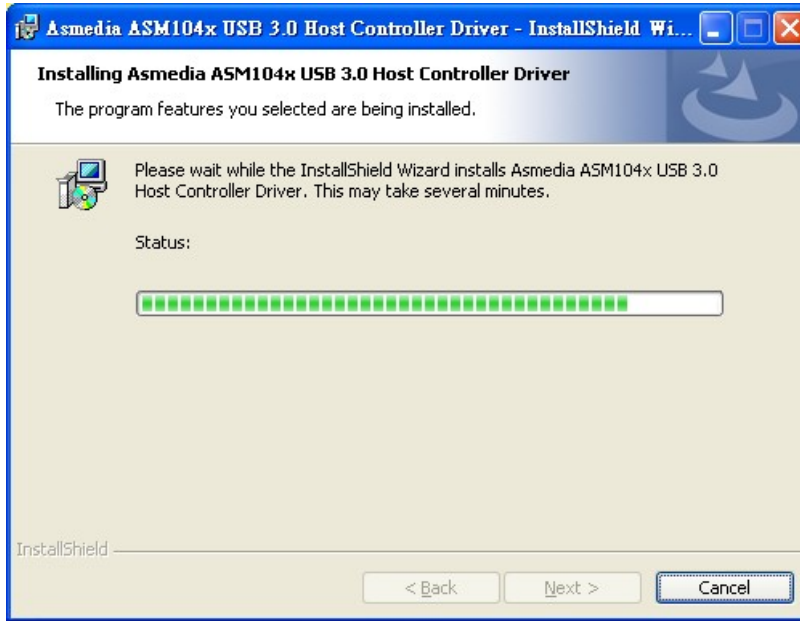

Figure 6-33: USB 3.0 Driver Installation Screen

Step 9: When the installation is complete, click **FINISH** to exit setup. (Figure 6-34).

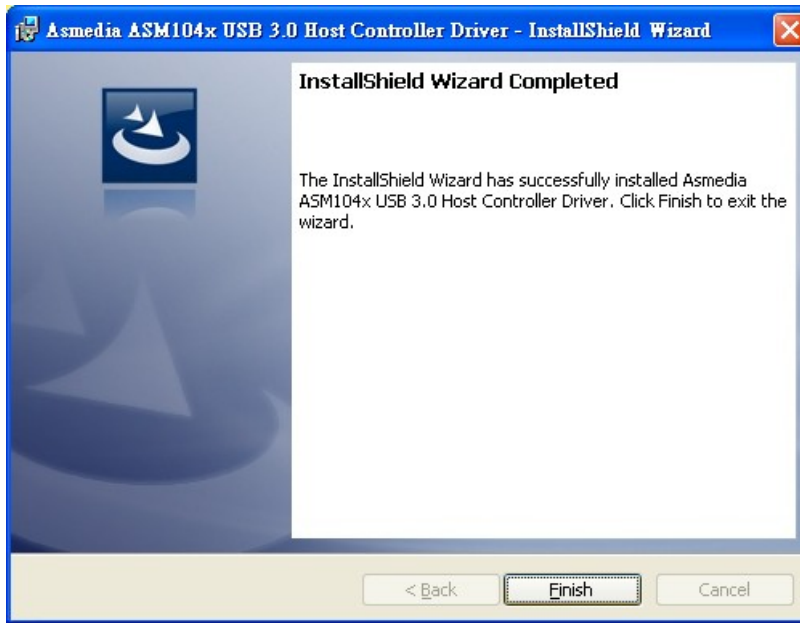

Figure 6-34: USB 3.0 Driver Update Complete

Appendix

A

BIOS Configuration Options

A.1 BIOS Configuration Options

Below is a list of BIOS configuration options described in **Chapter 5**.

BIOS Information	68
System Date [xx/xx/xx]	68
System Time [xx:xx:xx]	69
ACPI Sleep State [S1 (CPU Stop Clock)]	70
Power Saving Function [Disabled]	70
Hyper Threading Function [Enabled]	72
ATA/IDE Configurations [Enhanced]	72
Configure SATA as [IDE]	73
USB Devices	74
Legacy USB Support [Enabled]	74
USB3.0 Support [Enabled]	74
Serial Port [Enabled]	76
Change Settings [Auto]	76
Serial Port [Enabled]	76
Change Settings [Auto]	77
Serial Port [Enabled]	77
Change Settings [Auto]	77
Serial Port 3 Mode [RS232]	78
Serial Port [Enabled]	78
Change Settings [Auto]	78
Serial Port 4 Mode [RS422/485]	79
Serial Port [Enabled]	79
Change Settings [Auto]	79
Serial Port 5 Mode [RS422/485]	80
Serial Port [Enabled]	80
Change Settings [Auto]	80
PC Health Status	82
Console Redirection [Disabled]	83
Terminal Type [ANSI]	84
Bits per second [115200]	84
Auto Recovery Function [Disabled]	85

Restore on AC Power Loss [Last State]	87
HD Audio Controller [Enabled]	87
USB Function [Enabled]	88
USB 2.0 (EHCI) Support [Enabled]	88
Set Spread Spectrum function [Disabled]	88
WIFI Support [Enabled]	88
Auto Dimming Support [Enabled]	88
DVMT Mode Select [DVMT Mode]	89
DVMT/FIXED Memory [Maximum]	89
IGD - Boot Type [VBIOS Default]	90
LCD Panel Type [1024x768 18bit]	90
Bootup NumLock State [On]	91
Quiet Boot [Enabled]	92
Launch PXE OpROM [Disabled]	92
Save Changes and Reset	93
Discard Changes and Reset	93
Restore Defaults	93
Save as User Defaults	93
Restore User Defaults	93

C

Safety Precautions

**WARNING:**

The precautions outlined in this chapter should be strictly followed. Failure to follow these precautions may result in permanent damage to the EP series.

B.1 Safety Precautions

Please follow the safety precautions outlined in the sections that follow:

B.1.1 General Safety Precautions

Please ensure the following safety precautions are adhered to at all times.

- **Follow the electrostatic precautions** outlined below whenever the EP series is opened.
- **Make sure the power is turned off and the power cord is disconnected** whenever the EP series is being installed, moved or modified.
- **Do not apply voltage levels that exceed the specified voltage range.** Doing so may cause fire and/or an electrical shock.
- **Electric shocks can occur** if the EP series chassis is opened when the EP series is running.
- **Do not drop or insert any objects** into the ventilation openings of the EP series.
- **If considerable amounts of dust, water, or fluids enter the EP series**, turn off the power supply immediately, unplug the power cord, and contact the EP series vendor.
- **DO NOT:**
 - Drop the EP series against a hard surface.
 - Strike or exert excessive force onto the LCD panel.
 - Touch any of the LCD panels with a sharp object
 - In a site where the ambient temperature exceeds the rated temperature

B.1.2 Anti-static Precautions



WARNING:

Failure to take ESD precautions during the installation of the EP series may result in permanent damage to the EP series and severe injury to the user.

Electrostatic discharge (ESD) can cause serious damage to electronic components, including the EP series. Dry climates are especially susceptible to ESD. It is therefore critical that whenever the EP series is opened and any of the electrical components are handled, the following anti-static precautions are strictly adhered to.

- ***Wear an anti-static wristband:*** Wearing a simple anti-static wristband can help to prevent ESD from damaging any electrical component.
- ***Self-grounding:*** Before handling any electrical component, touch any grounded conducting material. During the time the electrical component is handled, frequently touch any conducting materials that are connected to the ground.
- ***Use an anti-static pad:*** When configuring or working with an electrical component, place it on an anti-static pad. This reduces the possibility of ESD damage.
- ***Only handle the edges of the electrical component:*** When handling the electrical component, hold the electrical component by its edges.

B.1.3 Product Disposal



CAUTION:

Risk of explosion if battery is replaced by an incorrect type. Only certified engineers should replace the on-board battery.

Dispose of used batteries according to instructions and local regulations.

- Outside the European Union - If you wish to dispose of used electrical and electronic products outside the European Union, please contact your local authority so as to comply with the correct disposal method.
- Within the European Union:

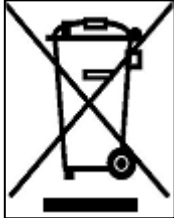

EU-wide legislation, as implemented in each Member State, requires that waste electrical and electronic products carrying the mark (left) must be disposed of separately from normal household waste. This includes monitors and electrical accessories, such as signal cables or power cords. When you need to dispose of your display products, please follow the guidance of your local authority, or ask the shop where you purchased the product. The mark on electrical and electronic products only applies to the current European Union Member States.

Please follow the national guidelines for electrical and electronic product disposal.

B.2 Maintenance and Cleaning Precautions

When maintaining or cleaning the EP series, please follow the guidelines below.

B.2.1 Maintenance and Cleaning

Prior to cleaning any part or component of the EP series, please read the details below.

- Except for the LCD panel, never spray or squirt liquids directly onto any other components. To clean the LCD panel, gently wipe it with a piece of soft dry cloth or a slightly moistened cloth.
- The interior of the EP series does not require cleaning. Keep fluids away from the EP series interior.
- Be cautious of all small removable components when vacuuming the EP series.
- Turn the EP series off before cleaning the EP series.
- Never drop any objects or liquids through the openings of the EP series.
- Be cautious of any possible allergic reactions to solvents or chemicals used when cleaning the EP series.
- Avoid eating, drinking and smoking within vicinity of the EP series.

B.2.2 Cleaning Tools

Some components in the EP series may only be cleaned using a product specifically designed for the purpose. In such case, the product will be explicitly mentioned in the cleaning tips. Below is a list of items to use when cleaning the EP series.

- **Cloth** – Although paper towels or tissues can be used, a soft, clean piece of cloth is recommended when cleaning the EP series.
- **Water or rubbing alcohol** – A cloth moistened with water or rubbing alcohol can be used to clean the EP series.
- **Using solvents** – The use of solvents is not recommended when cleaning the EP series as they may damage the plastic parts.
- **Vacuum cleaner** – Using a vacuum specifically designed for computers is one of the best methods of cleaning the EP series. Dust and dirt can restrict the airflow in the EP series and cause its circuitry to corrode.
- **Cotton swabs** - Cotton swaps moistened with rubbing alcohol or water are excellent tools for wiping hard to reach areas.
- **Foam swabs** - Whenever possible, it is best to use lint free swabs such as foam swabs for cleaning.

Appendix

D

Watchdog Timer



NOTE:

The following discussion applies to DOS environment. IEI support is contacted or the IEI website visited for specific drivers for more sophisticated operating systems, e.g., Windows and Linux.

The Watchdog Timer is provided to ensure that standalone systems can always recover from catastrophic conditions that cause the CPU to crash. This condition may have occurred by external EMI or a software bug. When the CPU stops working correctly, Watchdog Timer either performs a hardware reset (cold boot) or a Non-Maskable Interrupt (NMI) to bring the system back to a known state.

A BIOS function call (INT 15H) is used to control the Watchdog Timer:

INT 15H:

AH – 6FH Sub-function:	
AL – 2:	Sets the Watchdog Timer's period.
BL:	Time-out value (Its unit-second is dependent on the item "Watchdog Timer unit select" in CMOS setup).

Table C-1: AH-6FH Sub-function

Call sub-function 2 to set the time-out period of Watchdog Timer first. If the time-out value is not zero, the Watchdog Timer starts counting down. While the timer value reaches zero, the system resets. To ensure that this reset condition does not occur, calling sub-function 2 must periodically refresh the Watchdog Timer. However, the Watchdog timer is disabled if the time-out value is set to zero.

A tolerance of at least 10% must be maintained to avoid unknown routines within the operating system (DOS), such as disk I/O that can be very time-consuming.

**NOTE:**

When exiting a program it is necessary to disable the Watchdog Timer, otherwise the system resets.

Example program:

```
; INITIAL TIMER PERIOD COUNTER
;
W_LOOP:

    MOV     AX, 6F02H      ;setting the time-out value
    MOV     BX, 05        ;time-out value is 5 seconds
    INT     15H

;
; ADD THE APPLICATION PROGRAM HERE
;

    CMP     EXIT_AP, 1    ;is the application over?
    JNE     W_LOOP       ;No, restart the application

    MOV     AX, 6F02H    ;disable Watchdog Timer
    MOV     BX, 0        ;
    INT     15H

;
; EXIT ;
```

Appendix

E

Hazardous Materials Disclosure

D.1 Hazardous Material Disclosure Table for IPB Products Certified as RoHS Compliant Under 2002/95/EC Without Mercury

The details provided in this appendix are to ensure that the product is compliant with the Peoples Republic of China (China) RoHS standards. The table below acknowledges the presences of small quantities of certain materials in the product, and is applicable to China RoHS only.

A label will be placed on each product to indicate the estimated “Environmentally Friendly Use Period” (EFUP). This is an estimate of the number of years that these substances would “not leak out or undergo abrupt change.” This product may contain replaceable sub-assemblies/components which have a shorter EFUP such as batteries and lamps. These components will be separately marked.

Please refer to the table on the next page.

PPC-5152-D525 Falt-bezel Panel PC

Part Name	Toxic or Hazardous Substances and Elements					
	Lead (Pb)	Mercury (Hg)	Cadmium (Cd)	Hexavalent Chromium (CR(VI))	Polybrominated Biphenyls (PBB)	Polybrominated Diphenyl Ethers (PBDE)
Housing	O	O	O	O	O	O
Display	O	O	O	O	O	O
Printed Circuit Board	O	O	O	O	O	O
Metal Fasteners	O	O	O	O	O	O
Cable Assembly	O	O	O	O	O	O
Fan Assembly	O	O	O	O	O	O
Power Supply Assemblies	O	O	O	O	O	O
Battery	O	O	O	O	O	O

O: This toxic or hazardous substance is contained in all of the homogeneous materials for the part is below the limit requirement in SJ/T11363-2006

X: This toxic or hazardous substance is contained in at least one of the homogeneous materials for this part is above the limit requirement in SJ/T11363-2006

此附件旨在确保本产品符合中国 RoHS 标准。以下表格标示此产品中某有毒物质的含量符合中国 RoHS 标准规定的限量要求。

本产品上会附有“环境友好使用期限”的标签，此期限是估算这些物质“不会有泄漏或突变”的年限。本产品可能包含有较短的环境友好使用期限的可替换元件，像是电池或灯管，这些元件将会单独标示出来。

部件名称	有毒有害物质或元素					
	铅 (Pb)	汞 (Hg)	镉 (Cd)	六价铬 (CR(VI))	多溴联苯 (PBB)	多溴二苯醚 (PBDE)
壳体	O	O	O	O	O	O
显示	O	O	O	O	O	O
印刷电路板	O	O	O	O	O	O
金属螺帽	O	O	O	O	O	O
电缆组装	O	O	O	O	O	O
风扇组装	O	O	O	O	O	O
电力供应组装	O	O	O	O	O	O
电池	O	O	O	O	O	O

O: 表示该有毒有害物质在该部件所有物质材料中的含量均在 SJ/T11363-2006 标准规定的限量要求以下。
X: 表示该有毒有害物质至少在该部件的某一均质材料中的含量超出 SJ/T11363-2006 标准规定的限量要求。