



IEI Technology Corp.



MODEL:
TANK-101B/BW

Fanless Embedded System with Intel® Atom™ D525/N455 CPU, On-board 1.0 GB DDR3 Memory, Two Isolated CAN-bus Ports, One Isolated Serial Port, RoHS Compliant

User Manual

Rev. 1.10 – 30 May, 2013



Revision

Date	Version	Changes
30 May, 2013	1.10	Updated for TANK-101BW-R11/D525/1GB
6 June, 2012	1.02	Added FCC Warning Added High Surface Temperature Warning in Section 3.1: Installation Precautions
30 March, 2012	1.01	Removed RS-422/485 function select jumper description Updated RS-422/485 serial port connector pinouts Updated Appendix A: One Key Recovery
11 August, 2011	1.00	Initial release

Copyright

COPYRIGHT NOTICE

The information in this document is subject to change without prior notice in order to improve reliability, design and function and does not represent a commitment on the part of the manufacturer.

In no event will the manufacturer be liable for direct, indirect, special, incidental, or consequential damages arising out of the use or inability to use the product or documentation, even if advised of the possibility of such damages.

This document contains proprietary information protected by copyright. All rights are reserved. No part of this manual may be reproduced by any mechanical, electronic, or other means in any form without prior written permission of the manufacturer.

TRADEMARKS

All registered trademarks and product names mentioned herein are used for identification purposes only and may be trademarks and/or registered trademarks of their respective owners.

WARNING

This device complies with Part 15 of the FCC Rules. Operation is subject to the following two conditions:

(1) this device may not cause harmful interference, and(2) this device must accept any interference received, including interference that may cause undesired operation.

NOTE: This equipment has been tested and found to comply with the limits for a Class B digital device, pursuant to part 15 of the FCC Rules. These limits are designed to provide reasonable protection against harmful interference in a residential installation. This equipment generates, uses and can radiate radio frequency energy and, if not installed and used in accordance with the instructions, may cause harmful interference to radio communications.

However, there is no guarantee that interference will not occur in a particular installation. If this equipment does cause harmful interference to radio or television reception, which can be determined by turning the equipment off and on, the user is encouraged to try to correct the interference by one or more of the following measures:

- Reorient or relocate the receiving antenna.
- Increase the separation between the equipment and receiver.
- Connect the equipment into an outlet on a circuit different from that to which the receiver is connected.
- Consult the dealer or an experienced radio/ TV technician for help.

You are cautioned that any change or modifications to the equipment not expressly approve by the party responsible for compliance could void your authority to operate such equipment.

IMPORTANT NOTE:

FCC Radiation Exposure Statement:

This equipment complies with FCC radiation exposure limits set forth for an uncontrolled environment. This equipment should be installed and operated with minimum distance 20cm between the radiator & your body.

Table of Contents

1 INTRODUCTION.....	1
1.1 OVERVIEW.....	2
1.2 MODEL VARIATIONS	2
1.3 FEATURES.....	3
1.4 TECHNICAL SPECIFICATIONS	3
1.5 CONNECTOR PANEL.....	5
1.5.1 Front Panel	5
1.5.2 Rear Panel	6
1.6 DIMENSIONS.....	7
2 UNPACKING	8
2.1 ANTI-STATIC PRECAUTIONS	9
2.2 UNPACKING PRECAUTIONS.....	9
2.3 UNPACKING CHECKLIST	10
3 INSTALLATION	12
3.1 INSTALLATION PRECAUTIONS	13
3.1.1 High Surface Temperature	13
3.2 CF CARD INSTALLATION	14
3.3 HARD DISK DRIVE (HDD) INSTALLATION.....	15
3.4 MOUNTING THE SYSTEM WITH MOUNTING BRACKETS	16
3.5 MOUNTING THE SYSTEM WITH WALL MOUNT KIT	17
3.6 JUMPER SETTINGS	20
3.6.1 Clear CMOS Jumper.....	20
3.7 EXTERNAL PERIPHERAL INTERFACE CONNECTORS.....	21
3.7.1 Audio Connector	21
3.7.2 CAN-bus Connectors	22
3.7.3 CompactFlash® Card Slot.....	22
3.7.4 LAN Connectors.....	22
3.7.5 3-pin Power Terminal Block	24
3.7.6 RS-232 Serial Port Connectors.....	25

3.7.7 RS-422/485 Serial Port Connector	26
3.7.8 USB Connectors.....	27
3.7.9 VGA Connector.....	28
4 BIOS.....	31
4.1 INTRODUCTION.....	32
4.1.1 Starting Setup.....	32
4.1.2 Using Setup	32
4.1.3 Getting Help.....	33
4.1.4 Unable to Reboot After Configuration Changes.....	33
4.1.5 BIOS Menu Bar.....	33
4.2 MAIN.....	34
4.3 ADVANCED.....	35
4.3.1 ACPI Settings	36
4.3.2 Trusted Computing	37
4.3.3 CPU Configuration.....	37
4.3.4 IDE Configuration	38
4.3.5 USB Configuration.....	40
4.3.6 Super IO Configuration	41
4.3.6.1 Serial Port n Configuration	42
4.3.7 H/W Monitor	46
4.3.8 Serial Port Console Redirection	47
4.4 CHIPSET	49
4.4.1 Host Bridge Configuration	50
4.4.1.1 OnChip VGA Configuration	51
4.4.2 South Bridge Configuration.....	51
4.4.3 Intel IGD SWSCI OpRegion.....	53
4.5 BOOT.....	54
4.6 SECURITY.....	55
4.7 EXIT	57
A ONE KEY RECOVERY	59
A.1 ONE KEY RECOVERY INTRODUCTION	60
A.1.1 System Requirement.....	61
A.1.2 Supported Operating System.....	62

TANK-101B/BW Embedded System

A.2 SETUP PROCEDURE FOR WINDOWS.....	63
A.2.1 <i>Hardware and BIOS Setup</i>	64
A.2.2 <i>Create Partitions</i>	64
A.2.3 <i>Install Operating System, Drivers and Applications</i>	68
A.2.4 <i>Build-up Recovery Partition</i>	69
A.2.5 <i>Create Factory Default Image</i>	71
A.3 AUTO RECOVERY SETUP PROCEDURE.....	76
A.4 SETUP PROCEDURE FOR LINUX.....	80
A.5 RECOVERY TOOL FUNCTIONS	84
A.5.1 <i>Factory Restore</i>	85
A.5.2 <i>Backup System</i>	86
A.5.3 <i>Restore Your Last Backup</i>	87
A.5.4 <i>Manual</i>	88
A.6 RESTORE SYSTEMS FROM A LINUX SERVER THROUGH LAN.....	89
A.6.1 <i>Configure DHCP Server Settings</i>	90
A.6.2 <i>Configure TFTP Settings</i>	91
A.6.3 <i>Configure One Key Recovery Server Settings</i>	92
A.6.4 <i>Start the DHCP, TFTP and HTTP</i>	93
A.6.5 <i>Create Shared Directory</i>	93
A.6.6 <i>Setup a Client System for Auto Recovery</i>	94
A.7 OTHER INFORMATION	97
A.7.1 <i>Using AHCI Mode or ALi M5283 / VIA VT6421A Controller</i>	97
A.7.2 <i>System Memory Requirement</i>	99
B SAFETY PRECAUTIONS	100
B.1 SAFETY PRECAUTIONS.....	101
B.1.1 <i>General Safety Precautions</i>	101
B.1.2 <i>Anti-static Precautions</i>	102
B.1.3 <i>Product Disposal</i>	103
B.2 MAINTENANCE AND CLEANING PRECAUTIONS	103
B.2.1 <i>Maintenance and Cleaning</i>	103
B.2.2 <i>Cleaning Tools</i>	104
C HAZARDOUS MATERIALS DISCLOSURE	105
C.1 HAZARDOUS MATERIALS DISCLOSURE TABLE FOR IPB PRODUCTS CERTIFIED AS	

RoHS COMPLIANT UNDER 2002/95/EC WITHOUT MERCURY 106

List of Figures

Figure 1-1: TANK-101B/BW	2
Figure 1-2: TANK-101B/BW Front Panel.....	5
Figure 1-3: TANK-101B/BW Rear Panel.....	6
Figure 1-4: Physical Dimensions (millimeters).....	7
Figure 3-1: CF Card Slot	14
Figure 3-2: CF Card Installation	15
Figure 3-3: Bottom Panel Retention Screws.....	15
Figure 3-4: HDD Installation	16
Figure 3-5: Retention Screw Holes	17
Figure 3-6: Wall-mounting Bracket.....	18
Figure 3-7: Mount the Embedded System.....	19
Figure 3-8: Audio Connector	21
Figure 3-9: CAN-bus Connector Pinout Location	22
Figure 3-10: LAN Connection	23
Figure 3-11: RJ-45 Ethernet Connector.....	24
Figure 3-12: 3-pin Terminal Block Pinout Location	24
Figure 3-13: Serial Device Connector.....	25
Figure 3-14: RS-232 Serial Port Pinout Location.....	26
Figure 3-15: RS-422/485 Serial Port Pinout Location.....	27
Figure 3-16: USB Device Connection	28
Figure 3-17: VGA Connector	29
Figure 3-18: VGA Connector	29
Figure A-1: IEI One Key Recovery Tool Menu	60
Figure A-2: Launching the Recovery Tool	65
Figure A-3: Recovery Tool Setup Menu	65
Figure A-4: Command Mode.....	66
Figure A-5: Partition Creation Commands.....	67
Figure A-6: Launching the Recovery Tool	69
Figure A-7: System Configuration for Windows	69
Figure A-8: Building the Recovery Partition.....	70

Figure A-9: Press Any Key to Continue	70
Figure A-10: Press F3 to Boot into Recovery Mode.....	71
Figure A-11: Recovery Tool Menu	71
Figure A-12: About Symantec Ghost Window.....	72
Figure A-13: Symantec Ghost Path	72
Figure A-14: Select a Local Source Drive	73
Figure A-15: Select a Source Partition from Basic Drive	73
Figure A-16: File Name to Copy Image to	74
Figure A-17: Compress Image.....	74
Figure A-18: Image Creation Confirmation	75
Figure A-19: Image Creation Process.....	75
Figure A-20: Image Creation Complete	75
Figure A-21: Press Any Key to Continue	76
Figure A-22: Auto Recovery Utility	77
Figure A-23: Launching the Recovery Tool	77
Figure A-24: Auto Recovery Environment for Windows	77
Figure A-25: Building the Auto Recovery Partition.....	78
Figure A-26: Factory Default Image Confirmation	78
Figure A-27: Image Creation Complete	79
Figure A-28: Press any key to continue	79
Figure A-29: Partitions for Linux.....	81
Figure A-30: Manual Recovery Environment for Linux	82
Figure A-31: Access menu.lst in Linux (Text Mode).....	83
Figure A-32: Recovery Tool Menu	83
Figure A-33: Recovery Tool Main Menu	84
Figure A-34: Restore Factory Default.....	85
Figure A-35: Recovery Complete Window	86
Figure A-36: Backup System.....	86
Figure A-37: System Backup Complete Window	87
Figure A-38: Restore Backup	87
Figure A-39: Restore System Backup Complete Window	88
Figure A-40: Symantec Ghost Window	88

List of Tables

Table 1-1: TANK-101B/BW Model Variations	2
Table 1-2: Technical Specifications.....	4
Table 3-1: Clear CMOS Jumper Settings.....	20
Table 3-2: CAN-bus Connector Pinouts	22
Table 3-3: LAN Pinouts	23
Table 3-4: RJ-45 Ethernet Connector LEDs	24
Table 3-5: RS-232 Serial Port Pinouts	26
Table 3-6: RS-422/485 Serial Port Pinouts	27
Table 3-7: USB Port Pinouts.....	28
Table 3-8: VGA Connector Pinouts.....	30
Table 4-1: BIOS Navigation Keys	33

Chapter

1

Introduction

1.1 Overview



Figure 1-1: TANK-101B/BW

The TANK-101B/BW fanless embedded system is powered by the Intel® Atom™ D525/N455 processor, uses the Intel® ICH8M chipset and has 1.0 GB of DDR3 memory. With typical voltage at 12V DC, TANK-101B/BW can take wide range DC input from 9V to 36V as power source. It also has COM and CAN-bus ports with isolation protection, dual Gigabit LAN and 802.11b/g/n wireless module for high speed communication. TANK-101B/BW supports all these versatile functions in a compact enclosure yet support fanless operation.

1.2 Model Variations

The model variations of the TANK-101B/BW are listed below.

Model No.	CPU	Wireless
TANK-101B-R10/D525/1GB	Intel® Atom™ D525 1.8 GHz dual core	No
TANK-101B-R10/N455/1GB	Intel® Atom™ N455 1.66 GHz	No
TANK-101BW-R11/D525/1GB	Intel® Atom™ D525 1.8 GHz dual core	Yes

Table 1-1: TANK-101B/BW Model Variations

TANK-101B/BW Embedded System

1.3 Features

The TANK-101B/BW features are listed below:

- Intel® Atom™ D525 1.8 GHz/N455 1.66 GHz processor
- 1.0 GB of DDR3 memory preinstalled
- Wide range 9V~36V DC power input
- Built-in 802.11b/g/n wireless module (for wireless model only)
- Two CAN-bus ports with isolation protection
- Two Gigabit Ethernet ports
- Four USB 2.0 ports
- Three RS-232 serial ports
- One RS-422/485 serial ports with isolation
- One VGA port
- One Line-out and one Mic-in audio jacks
- One CompactFlash® socket
- RoHS compliant

1.4 Technical Specifications

The TANK-101B/BW technical specifications are listed in **Table 1-2**.

Specifications	
CPU	1.8 GHz Intel® Atom™ D525 CPU with 1 MB L2 cache or 1.66 GHz Intel® Atom™ N455 CPU with 512 KB L2 cache
System Chipset	Intel® ICH8M
System Memory	1.0 GB of DDR3 memory preinstalled One 204-pin DDR3 SDRAM SO-DIMM slot (system max. 2.0 GB)
Ethernet	Dual Realtek RTL8111E PCIe GbE controllers (LAN1 with ASF 2.0 support) Built-in 802.11b/g/n wireless module for the wireless model
Serial Port	3 x RS-232 serial port (COM4: With isolation) 1 x RS-422/485 serial port with isolation (Default: RS-422)
USB	4 x USB 2.0 ports

Specifications	
Display	1 x VGA port
Resolution	Up to 2048x1536 @ 60 Hz (D525 model) Up to 1400x1050 @ 60 Hz (N455 model)
Audio	1 x Line-out port 1 x Mic-in port
CAN-bus	2 x CAN-bus ports with isolation
Expansions	One PCIe Mini card slot (reserved for wireless module)
Storage	One 2.5" SATA HDD supported One CompactFlash® socket
Power Supply	9V~36V DC input
Power Consumption	12 W @ 1.85A (Intel® Atom™ D525 1.8 GHz with 1 MB L2 cache, 1.0 GB DDR3 memory)
Mounting	Wall mount
Operating Temperature	-20°C~60°C (D525 model with CompactFlash®/SSD*) -20°C~70°C (N455 model with CompactFlash®/SSD*) -10°C~50°C (with Wi-Fi) <small>*Ambient air speed per IEC-68-2-2 standard</small>
Operating Shock	Half-sine wave shock 3G; 11ms; 3 shocks per axis
Operating Vibration	MIL-STD-810F 514.5C-1 (HDD) MIL-STD-810F 514.5C-2 (CF)
Color	Cool Gray + Blue
Chassis Construction	Aluminum alloy with heavy duty metal
Weight (Net/Gross)	2.1 kg/3.9 kg
Physical Dimensions	248 mm x 153 mm x 44 mm (W x D x H)

Table 1-2: Technical Specifications

TANK-101B/BW Embedded System

1.5 Connector Panel

1.5.1 Front Panel

The TANK-101B/BW front panel contains:

- 2 x CAN-bus ports with isolation
- 1 x CompactFlash® card socket
- 1 x HDD LED indicator
- 1 x Line-out port (green)
- 1 x Mic-in port (pink)
- 1 x Power LED indicator
- 1 x Reset button
- 2 x USB 2.0 port connectors

An overview of the front panel is shown in **Figure 1-2** below.

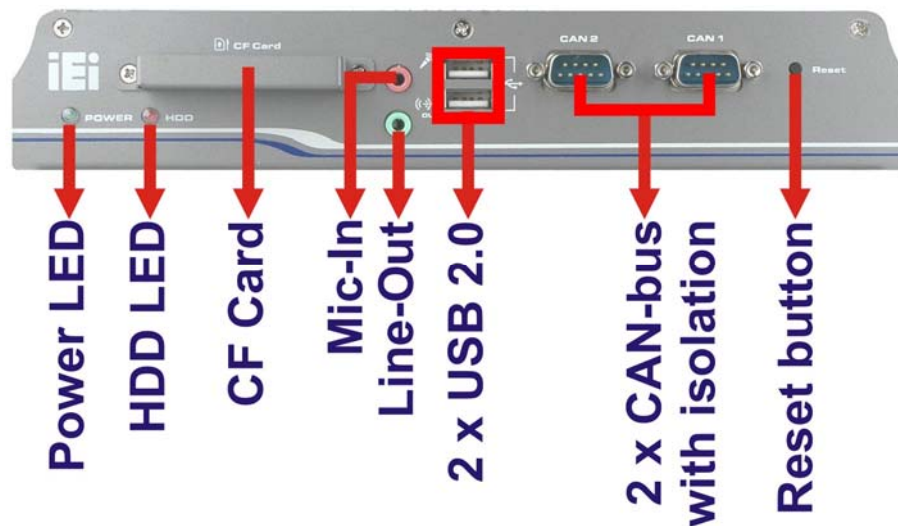

Figure 1-2: TANK-101B/BW Front Panel

1.5.2 Rear Panel

The TANK-101B/BW rear panel contains:

- 1 x VGA output
- 3 x RS-232 serial ports (COM4: With isolation)
- 1 x RS-422/485 serial port with isolation (Default: RS-422)
- 2 x USB port connectors
- 2 x Gigabit Ethernet ports (LAN1 with ASF 2.0 support)
- 1 x 12V DC power jack
- 1 x 3-pin power terminal block with wide range power input (9V~36V)
- 1 x Power switch
- 2 x Wireless antenna connectors (for wireless model only)

An overview of the rear panel is shown in **Figure 1-3** below.

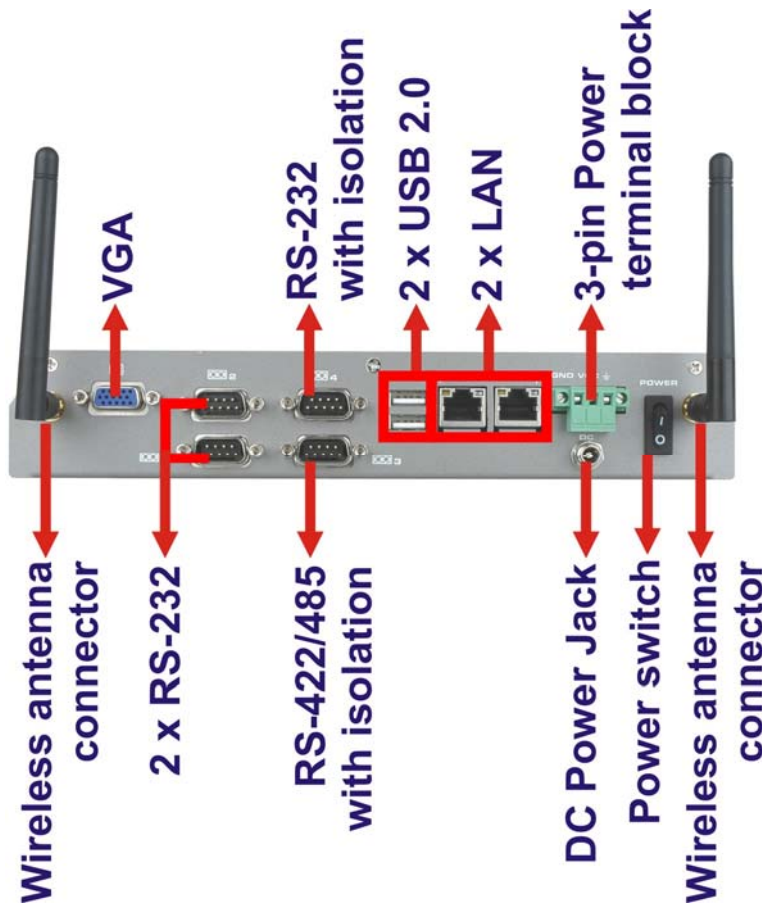

Figure 1-3: TANK-101B/BW Rear Panel

TANK-101B/BW Embedded System

1.6 Dimensions

The physical dimensions are shown below:

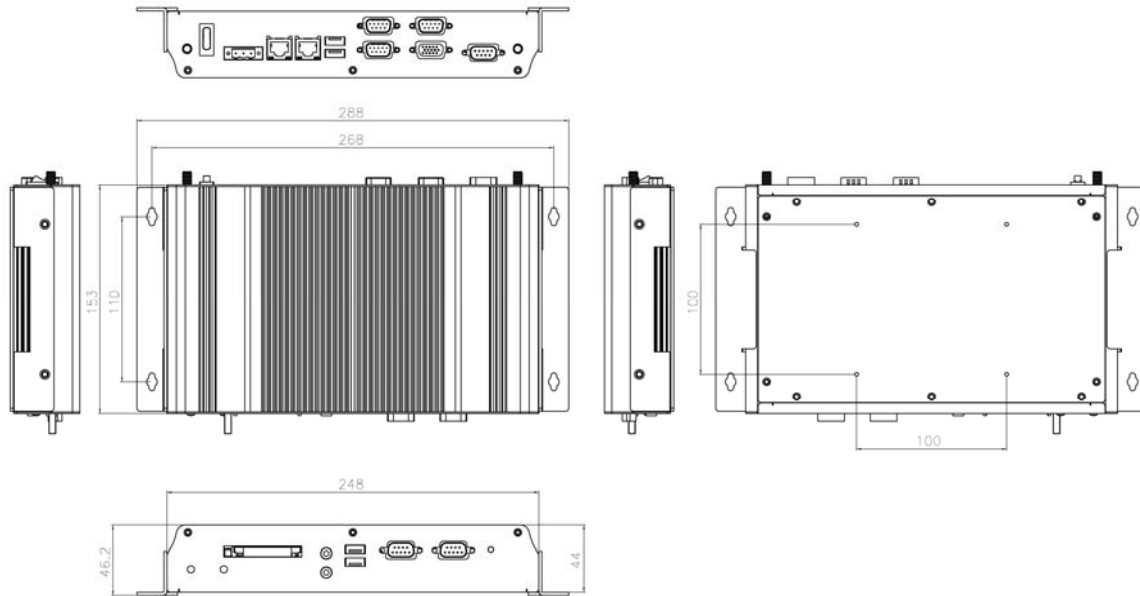

Figure 1-4: Physical Dimensions (millimeters)

Chapter

2

Unpacking

TANK-101B/BW Embedded System

2.1 Anti-static Precautions



WARNING:

Failure to take ESD precautions during installation may result in permanent damage to the TANK-101B/BW and severe injury to the user.

Electrostatic discharge (ESD) can cause serious damage to electronic components, including the TANK-101B/BW. Dry climates are especially susceptible to ESD. It is therefore critical that whenever the TANK-101B/BW or any other electrical component is handled, the following anti-static precautions are strictly adhered to.

- ***Wear an anti-static wristband:*** Wearing a simple anti-static wristband can help to prevent ESD from damaging the board.
- ***Self-grounding:*** Before handling the board touch any grounded conducting material. During the time the board is handled, frequently touch any conducting materials that are connected to the ground.
- ***Use an anti-static pad:*** When configuring the TANK-101B/BW, place it on an anti-static pad. This reduces the possibility of ESD damaging the TANK-101B/BW.

2.2 Unpacking Precautions

When the TANK-101B/BW is unpacked, please do the following:

- Follow the anti-static precautions outlined in **Section 2.1**.
- Make sure the packing box is facing upwards so the TANK-101B/BW does not fall out of the box.
- Make sure all the components shown in **Section 2.3** are present.





2.3 Unpacking Checklist







NOTE:

If some of the components listed in the checklist below are missing, please do not proceed with the installation. Contact the IEI reseller or vendor you purchased the TANK-101B/BW from or contact an IEI sales representative directly. To contact an IEI sales representative, please send an email to sales@iei.com.tw.

The TANK-101B/BW is shipped with the following components:

Quantity	Item and Part Number	Image
Standard		
1	TANK-101B/BW Series	
1	Power adapter (P/N: 63000-FSP060DBAB1552-RS)	
1	Power cord	
1	SATA and power cable	
2	Mounting bracket	

TANK-101B/BW Embedded System

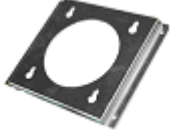
Quantity	Item and Part Number	Image
Standard		
1	Screw set	
1	Quick Installation Guide	
1	One Key Recovery CD	
1	User manual and driver CD (P/N: 7B000-000087-RS)	
2	Wireless antenna (wireless model only)	
1	VESA MIS-D 100 wall mount kit (optional)	

Chapter

3

Installation

TANK-101B/BW Embedded System

3.1 Installation Precautions

During installation, be aware of the precautions below:

- **Read the user manual:** The user manual provides a complete description of the TANK-101B/BW, installation instructions and configuration options.
- **DANGER! Disconnect Power:** Power to the TANK-101B/BW must be disconnected during the installation process, or before any attempt is made to access the rear panel. Electric shock and personal injury might occur if the rear panel of the TANK-101B/BW is opened while the power cord is still connected to an electrical outlet.
- **Qualified Personnel:** The TANK-101B/BW must be installed and operated only by trained and qualified personnel. Maintenance, upgrades, or repairs may only be carried out by qualified personnel who are familiar with the associated dangers.
- **Air Circulation:** Make sure there is sufficient air circulation when installing the TANK-101B/BW. The TANK-101B/BW's cooling vents must not be obstructed by any objects. Blocking the vents can cause overheating of the TANK-101B/BW. Leave at least 5 cm of clearance around the TANK-101B/BW to prevent overheating.
- **Grounding:** The TANK-101B/BW should be properly grounded. The voltage feeds must not be overloaded. Adjust the cabling and provide external overcharge protection per the electrical values indicated on the label attached to the back of the TANK-101B/BW.

3.1.1 High Surface Temperature



WARNING:

Some surfaces of the equipment may become hot during operation.

The surface temperature may be up to several tens of degrees hotter than the ambient temperature. Under these circumstances, the equipment needs to be protected against accidental contact.

The equipment is intended for installation in a RESTRICTED ACCESS LOCATION.

- Access can only be gained by SERVICE PERSONS or by USERS who have been instructed about the reasons for the restrictions applied to the location and about any precautions that shall be taken.
- Access is through the use of a TOOL or lock and key, or other means of security, and is controlled by the authority responsible for the location.

3.2 CF Card Installation

To install the CF card, please follow the steps below:

Step 1: Locate the CF card slot on the front panel of the TANK-101B/BW.

Step 2: Remove the CF card slot cover by removing the two retention screws (**Figure 3-1**).



Figure 3-1: CF Card Slot

Step 3: Insert the CF card into the slot (**Figure 3-2**).

TANK-101B/BW Embedded System



Figure 3-2: CF Card Installation

3.3 Hard Disk Drive (HDD) Installation

To install the hard drive, please follow the steps below:

Step 1: Remove the bottom panel by removing the 10 retention screws from the bottom panel (Figure 3-3).

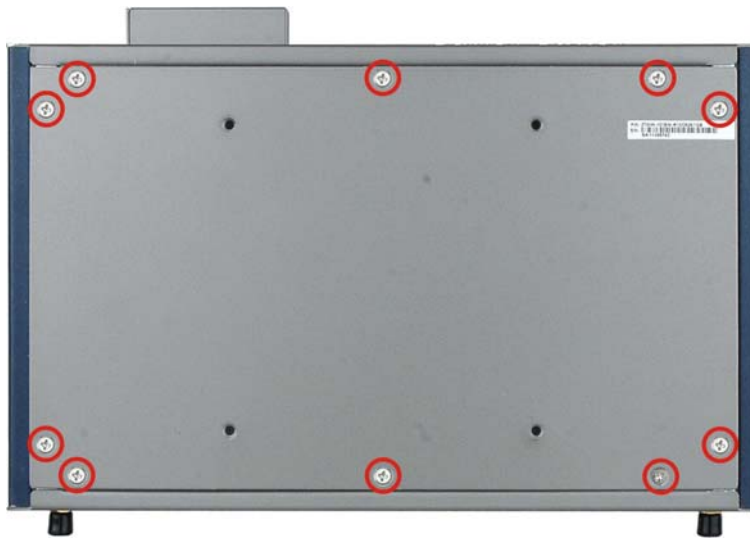

Figure 3-3: Bottom Panel Retention Screws

Step 2: Open the bottom panel, unplug the SATA signal and power cables connected to the TANK-101B/BW, and then put the bottom panel on a flat surface.

Step 3: Attach the HDD to the HDD bracket, and then slide the HDD to connect the HDD to the SATA connector (**Figure 3-4**).

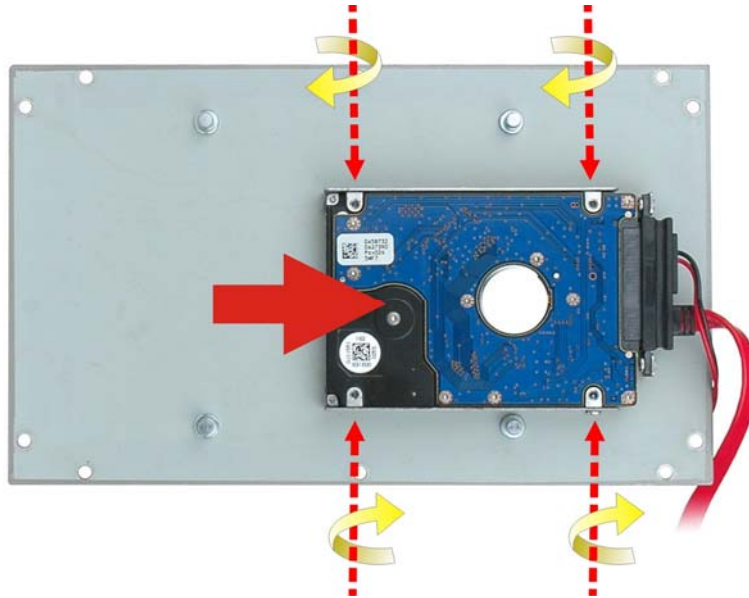

Figure 3-4: HDD Installation

Step 4: Secure the HDD with the HDD bracket by four retention screws (**Figure 3-4**).

Step 5: Reconnect the SATA signal and power cables to the TANK-101B/BW.

Step 6: Reinstall the bottom panel.

3.4 Mounting the System with Mounting Brackets

To mount the embedded system onto a wall or some other surface using the two mounting brackets, please follow the steps below.

Step 1: Turn the embedded system over.

Step 2: Align the two retention screw holes in each bracket with the corresponding retention screw holes on the sides of the bottom surface.

TANK-101B/BW Embedded System



Figure 3-5: Retention Screw Holes

- Step 3:** Secure the brackets to the system by inserting two retention screws into each bracket.
- Step 4:** Drill holes in the intended installation surface.
- Step 5:** Align the mounting holes in the sides of the mounting brackets with the predrilled holes in the mounting surface.
- Step 6:** Insert four retention screws, two in each bracket, to secure the system to the wall.

3.5 Mounting the System with Wall Mount Kit

To mount the embedded system onto a wall using the VESA MIS-D 100 wall mount kit, please follow the steps below.

- Step 1:** Select the location on the wall for the wall-mounting bracket.
- Step 2:** Carefully mark the locations of the four bracket screw holes on the wall.
- Step 3:** Drill four pilot holes at the marked locations on the wall for the bracket retention screws.
- Step 4:** Align the wall-mounting bracket screw holes with the pilot holes.

Step 5: Secure the mounting-bracket to the wall by inserting the retention screws into the four pilot holes and tightening them (**Figure 3-6**).

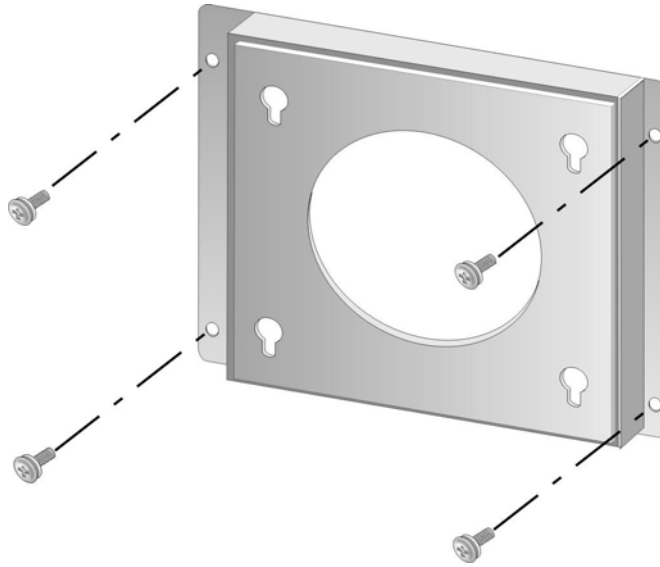

Figure 3-6: Wall-mounting Bracket

Step 6: Insert the four monitor mounting screws provided in the wall mounting kit into the four screw holes on the bottom panel of the system and tighten until the screw shank is secured against the bottom panel (**Figure 3-7**).

Step 7: Align the mounting screws on the TANK-101B/BW bottom panel with the mounting holes on the bracket.

Step 8: Carefully insert the screws through the holes and gently pull the monitor downwards until the TANK-101B/BW rests securely in the slotted holes (**Figure 3-7**). Ensure that all four of the mounting screws fit snugly into their respective slotted holes.



NOTE:

In the diagram below the bracket is already installed on the wall.

TANK-101B/BW Embedded System

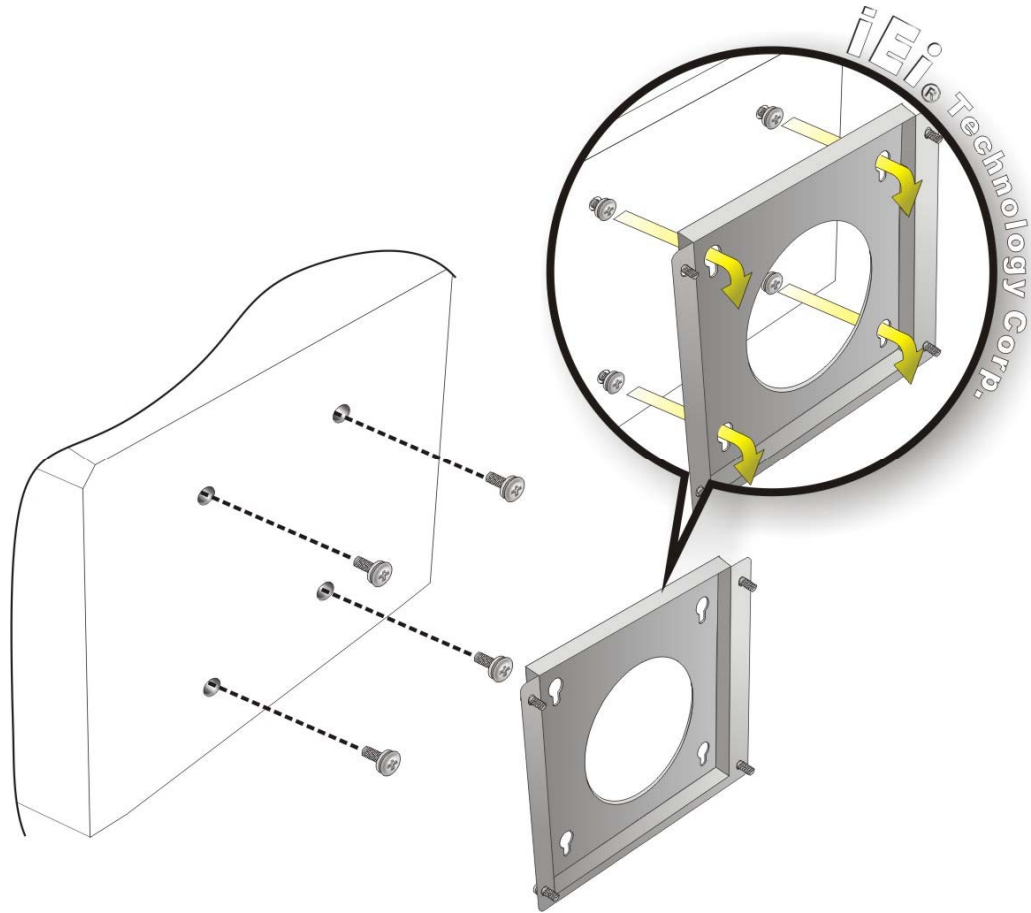

Figure 3-7: Mount the Embedded System

3.6 Jumper Settings



NOTE:

A jumper is a metal bridge used to close an electrical circuit. It consists of two or three metal pins and a small metal clip (often protected by a plastic cover) that slides over the pins to connect them. To CLOSE/SHORT a jumper means connecting the pins of the jumper with the plastic clip and to OPEN a jumper means removing the plastic clip from a jumper.

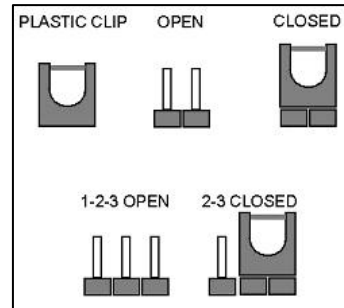

To access a jumper, please remove the bottom panel (refer to **Section 3.3**). The motherboard jumper is listed below.

- Clear CMOS jumper

3.6.1 Clear CMOS Jumper

Jumper Label: J_CMOS1
Jumper Type: 3-pin header
Jumper Settings: See **Table 3-1**

To reset the BIOS, move the jumper to the "Clear CMOS" position for 3 seconds or more, and then move back to the default position.

Setting	Description
Short 1-2	Normal
Short 2-3	Clear CMOS

Table 3-1: Clear CMOS Jumper Settings

TANK-101B/BW Embedded System

3.7 External Peripheral Interface Connectors

The TANK-101B/BW has the following connectors. Detailed descriptions of the connectors can be found in the subsections below.

- Audio
- CAN-bus
- CompactFlash® card
- Ethernet
- Power switch
- Power input
- Reset button
- RS-232
- RS-422/485
- USB
- VGA
- Wireless antenna (for wireless model only)

3.7.1 Audio Connector

CN Type: Audio jack

CN Location: See **Figure 3-8**

The audio jacks connect to external audio devices.

- **Line Out port (Green):** Connects to a headphone or a speaker. With multi-channel configurations, this port can also connect to front speakers.
- **Microphone (Pink):** Connects a microphone.



Figure 3-8: Audio Connector

3.7.2 CAN-bus Connectors

- CN Type:** DB-9 connector
- CN Location:** See **Figure 1-2**
- CN Pinouts:** See **Table 3-2** and **Figure 3-9**

There are two CAN-bus connectors with isolation. The pinouts for the CAN-bus connector are listed in the table below.

Pin	Description	Pin	Description
1	NC	6	NC
2	CANL	7	CANH
3	GND	8	NC
4	NC	9	NC
5	NC		

Table 3-2: CAN-bus Connector Pinouts

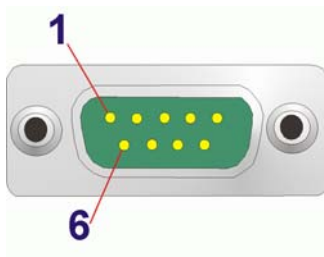

Figure 3-9: CAN-bus Connector Pinout Location

3.7.3 CompactFlash® Card Slot

The TANK-101B/BW has one CF card slot. To install the CF card, refer to **Section 3.2**.

3.7.4 LAN Connectors

- CN Type:** RJ-45
- CN Location:** See **Figure 1-3**
- CN Pinouts:** See **Table 3-3**

The LAN connectors allow connection to an external network.

TANK-101B/BW Embedded System

Step 1: Locate the RJ-45 connectors. The locations of the RJ-45 connectors are shown in **Figure 1-3**.

Step 2: Align the connectors. Align the RJ-45 connector on the LAN cable with one of the RJ-45 connectors on the TANK-101B/BW. See **Figure 3-10**.

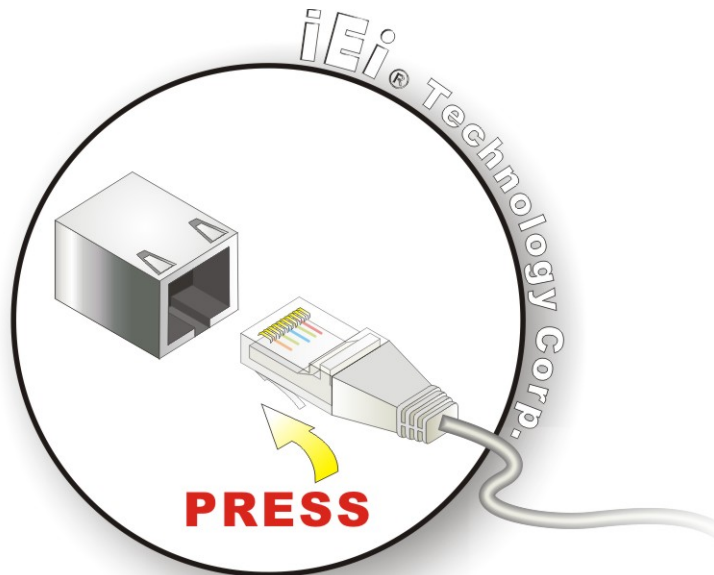

Figure 3-10: LAN Connection

Step 3: Insert the LAN cable RJ-45 connector. Once aligned, gently insert the LAN cable RJ-45 connector into the on-board RJ-45 connector.

Pin	Description	Pin	Description
1	TRD1P0	5	TRD1P2
2	TRD1N0	6	TRD1N2
3.	TRD1P1	7	TRD1P3
4.	TRD1N1	8	TRD1N3

Table 3-3: LAN Pinouts



Figure 3-11: RJ-45 Ethernet Connector

The RJ-45 Ethernet connector has two status LEDs, one green and one yellow. The green LED indicates activity on the port and the yellow LED indicates the port is linked. See **Table 3-4**.

Activity/Link LED		Speed LED	
STATUS	DESCRIPTION	STATUS	DESCRIPTION
Off	No link	Off	10 Mbps connection
Yellow	Linked	Green	100 Mbps connection
Blinking	TX/RX activity	Orange	1 Gbps connection

Table 3-4: RJ-45 Ethernet Connector LEDs

3.7.5 3-pin Power Terminal Block

CN Type: 3-pin terminal block

CN Location: See **Figure 1-3**

N Pinouts: See **Figure 3-12**

Connect the leads of a 9V~36V DC power supply into the terminal block. Make sure that the power and ground wires are attached to the correct sockets of the connector.

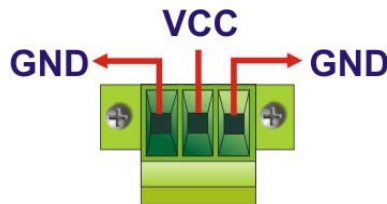

Figure 3-12: 3-pin Terminal Block Pinout Location

TANK-101B/BW Embedded System

3.7.6 RS-232 Serial Port Connectors

- CN Label:** COM1, COM2 and COM4
- CN Type:** DB-9 connectors
- CN Location:** See **Figure 1-3**
- CN Pinouts:** See **Table 3-5** and **Figure 3-14**

RS-232 serial port devices can be attached to the DB-9 ports on the rear panel.

Step 1: **Locate the DB-9 connector.** The locations of the DB-9 connectors are shown in **Figure 1-3**.

Step 2: **Insert the serial connector.** Insert the DB-9 connector of a serial device into the DB-9 connector on the external peripheral interface. See **Figure 3-13**.

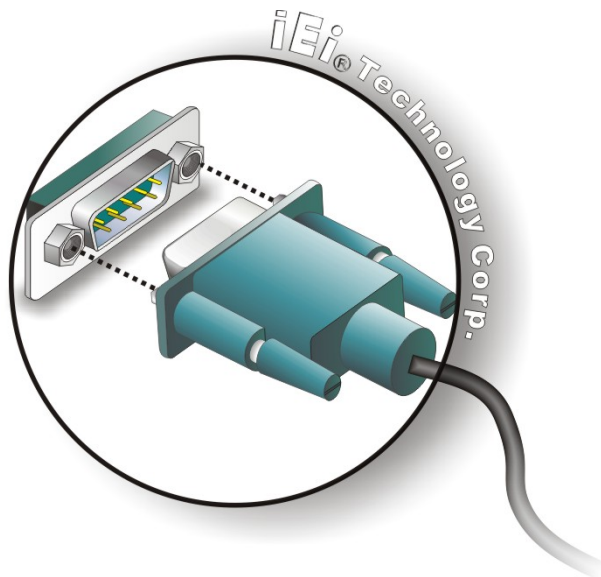
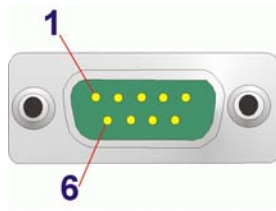

Figure 3-13: Serial Device Connector

Step 3: **Secure the connector.** Secure the serial device connector to the external interface by tightening the two retention screws on either side of the connector.

Pin	Description	Pin	Description
1	DCD	6	DSR
2	RX	7	RTS

Pin	Description	Pin	Description
3	TX	8	CTS
4	DTR	9	RI
5	GND		

Table 3-5: RS-232 Serial Port Pinouts

Figure 3-14: RS-232 Serial Port Pinout Location

3.7.7 RS-422/485 Serial Port Connector

- CN Label:** COM3
- CN Type:** DB-9 connector
- CN Location:** See **Figure 1-3**
- CN Pinouts:** See Error! Reference source not found. and **Figure 3-15**

The RS-422/485 serial port device can be attached to the DB-9 port on the rear panel.

Step 1: **Locate the DB-9 connector.** The location of the DB-9 connector is shown in **Figure 1-3**.

Step 2: **Insert the serial connector.** Insert the DB-9 connector of a serial device into the DB-9 connector on the external peripheral interface. See **Figure 3-13**.

Step 3: **Secure the connector.** Secure the serial device connector to the external interface by tightening the two retention screws on either side of the connector.

Pin	Description (RS-422)	Description (RS-485)
1	RXD422 #	N/A
2	RXD422 +	N/A
3	TXD422 +	TXD485 +
4	TXD422 #	TXD485 #

TANK-101B/BW Embedded System

5	GND	GND
6	N/A	N/A
7	N/A	N/A
8	N/A	N/A
9	N/A	N/A

Table 3-6: RS-422/485 Serial Port Pinouts

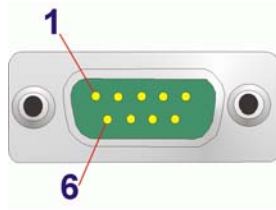

Figure 3-15: RS-422/485 Serial Port Pinout Location

3.7.8 USB Connectors

- CN Type:** USB port
- CN Location:** See **Figure 1-2** and **Figure 1-3**
- CN Pinouts:** See **Table 3-7**

The USB ports are for connecting USB peripheral devices to the system.

Step 1: Locate the USB connectors. The locations of the USB connectors are shown in **Figure 1-2** and **Figure 1-3**.

Step 2: **Align the connectors.** Align the USB device connector with one of the connectors. See **Figure 3-16**.

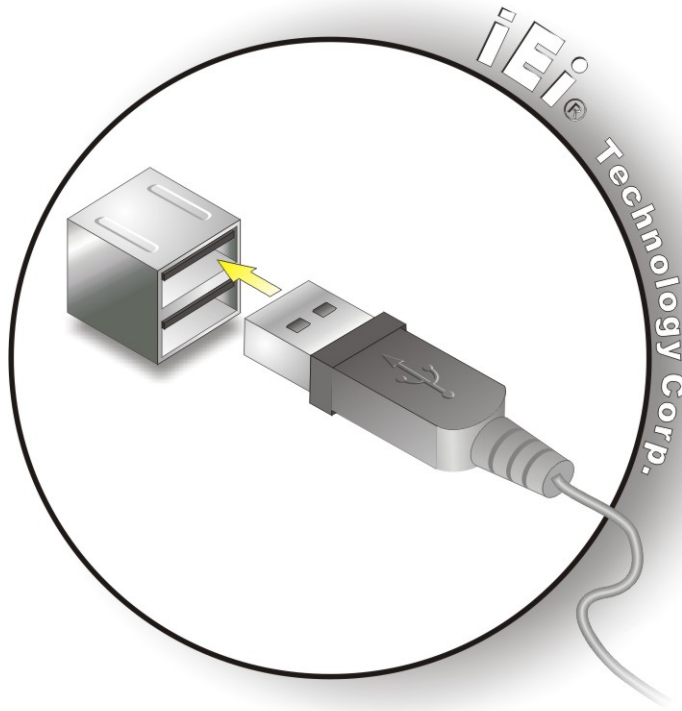

Figure 3-16: USB Device Connection

Step 3: Insert the device connector. Once aligned, gently insert the USB device connector into the on-board connector.

Pin	Description	Pin	Description
1	VCC	5	VCC
2	DATA-	6	DATA-
3	DATA+	7	DATA+
4	GROUND	8	GROUND

Table 3-7: USB Port Pinouts

3.7.9 VGA Connector

- CN Label:** VGA
- CN Type:** 15-pin Female
- CN Location:** See **Figure 1-2**
- CN Pinouts:** See **Figure 3-18** and **Table 3-8**

TANK-101B/BW Embedded System

The VGA connector connects to a monitor that accepts VGA video input.

- Step 1:** **Locate the female DB-15 connector.** The location of the female DB-15 connector is shown in **Figure 1-2**.
- Step 2:** **Align the VGA connector.** Align the male DB-15 connector on the VGA screen cable with the female DB-15 connector on the external peripheral interface.
- Step 3:** **Insert the VGA connector** Once the connectors are properly aligned with, insert the male connector from the VGA screen into the female connector on the TANK-101B/BW. See **Figure 3-17**.

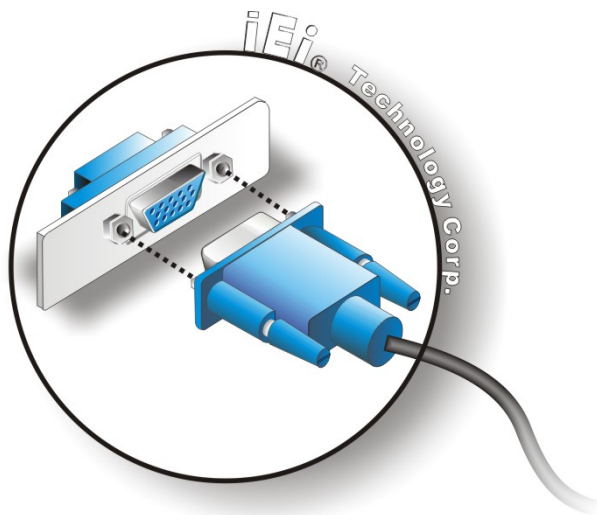

Figure 3-17: VGA Connector

- Step 4:** **Secure the connector.** Secure the DB-15 VGA connector from the VGA monitor to the external interface by tightening the two retention screws on either side of the connector.

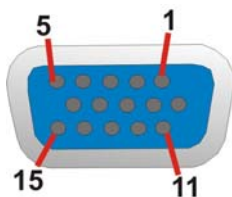

Figure 3-18: VGA Connector

Pin	Description	Pin	Description
1	RED	2	GREEN
3	BLUE	4	NC
5	GND	6	GND
7	GND	8	GND
9	VCC / NC	10	GND
11	NC	12	DDC DAT
13	HSYNC	14	VSYNC
15	DDCCLK		

Table 3-8: VGA Connector Pinouts

Chapter

4

BIOS

4.1 Introduction

The BIOS is programmed onto the BIOS chip. The BIOS setup program allows changes to certain system settings. This chapter outlines the options that can be changed.

4.1.1 Starting Setup

The UEFI BIOS is activated when the computer is turned on. The setup program can be activated in one of two ways.

1. Press the **DEL** or **F2** key as soon as the system is turned on or
2. Press the **DEL** or **F2** key when the “**Press DEL or F2 to enter SETUP**” message appears on the screen.

If the message disappears before the **DEL** or **F2** key is pressed, restart the computer and try again.

4.1.2 Using Setup

Use the arrow keys to highlight items, press **ENTER** to select, use the PageUp and PageDown keys to change entries, press **F1** for help and press **Esc** to quit. Navigation keys are shown in.

Key	Function
Up arrow	Move to previous item
Down arrow	Move to next item
Left arrow	Move to the item on the left hand side
Right arrow	Move to the item on the right hand side
+	Increase the numeric value or make changes
-	Decrease the numeric value or make changes
Page Up key	Increase the numeric value or make changes
Page Dn key	Decrease the numeric value or make changes

TANK-101B/BW Embedded System

Key	Function
Esc key	Main Menu – Quit and not save changes into CMOS Status Page Setup Menu and Option Page Setup Menu -- Exit current page and return to Main Menu
F1	General help, only for Status Page Setup Menu and Option Page Setup Menu
F2	Previous values
F3	Load optimized defaults
F4	Save changes and Exit BIOS

Table 4-1: BIOS Navigation Keys

4.1.3 Getting Help

When **F1** is pressed a small help window describing the appropriate keys to use and the possible selections for the highlighted item appears. To exit the Help Window press **Esc** or the **F1** key again.

4.1.4 Unable to Reboot After Configuration Changes

If the computer cannot boot after changes to the system configuration is made, CMOS defaults. Use the jumper described in Chapter 2.

4.1.5 BIOS Menu Bar

The **menu bar** on top of the BIOS screen has the following main items:

- Main – Changes the basic system configuration.
- Advanced – Changes the advanced system settings.
- Chipset – Changes the chipset settings.
- Boot – Changes the system boot configuration.
- Security – Sets User and Supervisor Passwords.
- Save & Exit – Selects exit options and loads default settings.

The following sections completely describe the configuration options found in the menu items at the top of the BIOS screen and listed above.

4.2 Main

The **Main** BIOS menu (**BIOS Menu 1**) appears when the **BIOS Setup** program is entered. The **Main** menu gives an overview of the basic system information.

```

Aptio Setup Utility - Copyright (C) 2010 American Megatrends, Inc.
Main  Advanced  Chipset  Boot  Security  Save & Exit

BIOS Information
BIOS Vendor                American Megatrends
Core Version               4.6.4.0 0.20
Compliancy                 UEFI 2.0
Project Version            E329A11.ROM
Build Date and Time       01/28/2011 11:53:40

System Date                [Mon 06/20/2011]
System Time                [15:10:27]

Access Level               Administrator

Set the Date. Use Tab to
switch between Data
elements.

-----
<=>: Select Screen
↑ ↓: Select Item
Enter>Select
+ - Change Opt.
F1  General Help
F2  Previous Values
F3  Optimized Defaults
F4  Save & Exit
ESC Exit

Version 2.02.1205. Copyright (C) 2010 American Megatrends, Inc.

```

BIOS Menu 1: Main

→ System Overview

The **BIOS Information** lists a brief summary of the BIOS. The fields in **BIOS Information** cannot be changed. The items shown in the system overview include:

- **BIOS Vendor:** Installed BIOS vendor
- **Core Version:** Current BIOS version
- **Project Version:** the board version
- **Build Date and Time:** Date and time the current BIOS version was made

The System Overview field also has two user configurable fields:

→ System Date [xx/xx/xx]

Use the **System Date** option to set the system date. Manually enter the day, month and year.

TANK-101B/BW Embedded System

→ System Time [xx:xx:xx]

Use the **System Time** option to set the system time. Manually enter the hours, minutes and seconds.

4.3 Advanced

Use the **Advanced** menu (**BIOS Menu 2**) to configure the CPU and peripheral devices through the following sub-menus:



WARNING!

Setting the wrong values in the sections below may cause the system to malfunction. Make sure that the settings made are compatible with the hardware.

```

Aptio Setup Utility - Copyright (C) 2010 American Megatrends, Inc.
Main  Advanced  Chipset  Boot  Security  Save & Exit
-----
> ACPI Settings
> Trusted Computing
> CPU Configuration
> IDE Configuration
> USB Configuration
> Super IO Configuration
> H/M Monitor
> Serial Port Console Redirection

System ACPI Parameters
-----
<=>: Select Screen
↑ ↓: Select Item
Enter>Select
+ - Change Opt.
F1 General Help
F2 Previous Values
F3 Optimized Defaults
F4 Save & Exit
ESC Exit

Version 2.02.1205. Copyright (C) 2010 American Megatrends, Inc.
    
```

BIOS Menu 2: Advanced

4.3.1 ACPI Settings

The **ACPI Settings** menu (**BIOS Menu 3**) configures the Advanced Configuration and Power Interface (ACPI) options.

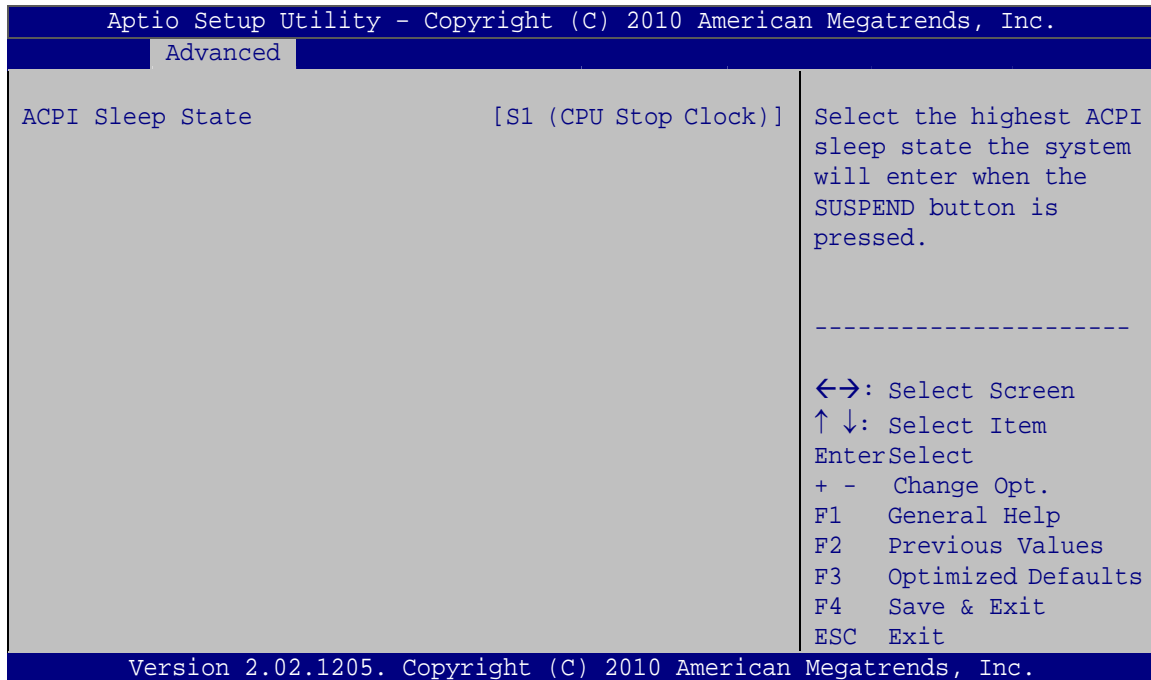

BIOS Menu 3: ACPI Configuration

→ ACPI Sleep State [S1 (CPU Stop Clock)]

Use the **ACPI Sleep State** option to specify the sleep state the system enters when it is not being used.

- **Suspend Disabled**
- **S1 (CPU Stop Clock)** **DEFAULT** The system enters S1(POS) sleep state. The system appears off. The CPU is stopped; RAM is refreshed; the system is running in a low power mode.
- **S3 (Suspend to RAM)** The caches are flushed and the CPU is powered off. Power to the RAM is maintained. The computer returns slower to a working state, but more power is saved.

TANK-101B/BW Embedded System

4.3.2 Trusted Computing

Use the **Trusted Computing** menu (**BIOS Menu 4**) to configure settings related to the Trusted Computing Group (TCG) Trusted Platform Module (TPM).

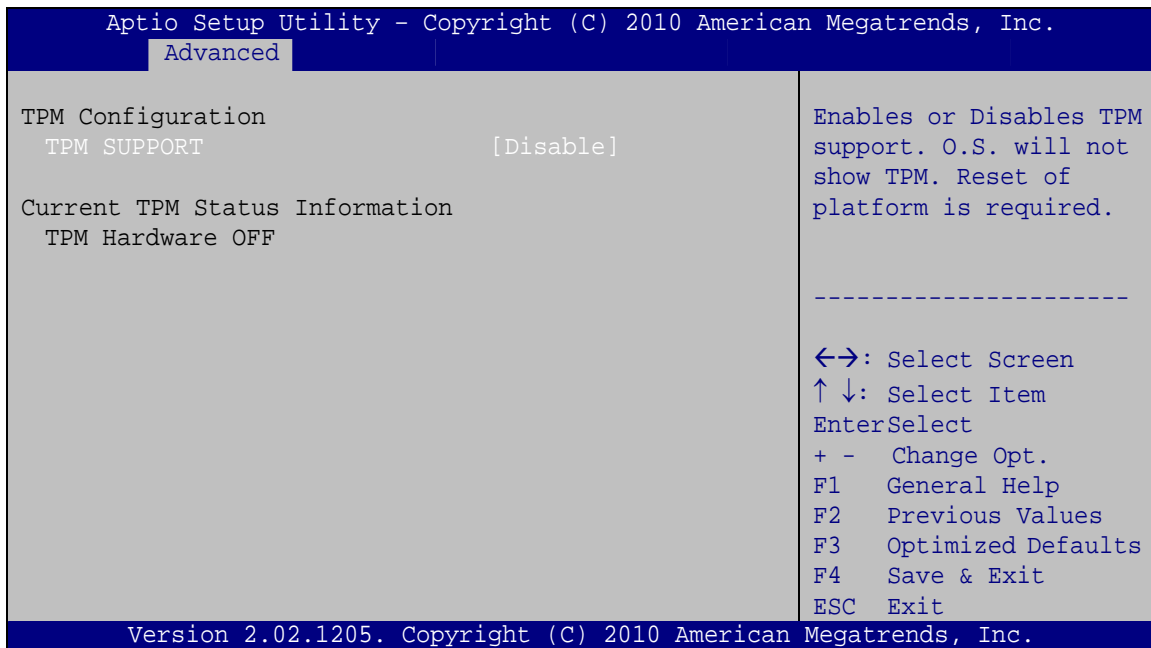

BIOS Menu 4: TPM Configuration

→ TPM Support [Disable]

Use the **TPM Support** option to configure support for the TPM.

→ **Disable** **DEFAULT** TPM support is disabled.

→ **Enable** TPM support is enabled.

4.3.3 CPU Configuration

Use the **CPU Configuration** menu (**BIOS Menu 5**) to view detailed CPU specifications and configure the CPU.

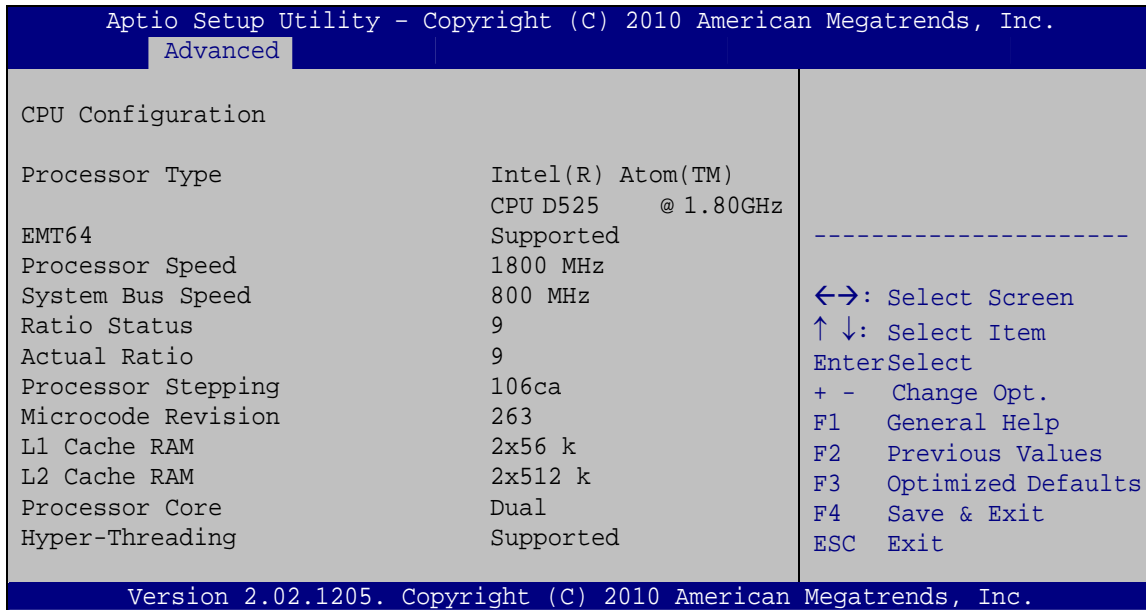

BIOS Menu 5: CPU Configuration

The CPU Configuration menu (**BIOS Menu 5**) lists the following CPU details:

- Processor Type: Lists the brand name of the CPU being used
- EMT64: Indicates if the EM64T is supported by the CPU.
- Processor Speed: Lists the CPU processing speed
- System Bus Speed: Lists the system bus
- Ratio Status: List the maximum FSB divisor
- Actual Ratio: Lists current FSB divisor
- Processor Stepping: Lists the CPU processing stepping
- Microcode Revision: Lists the microcode revision
- L1 Cache RAM: Lists the CPU L1 cache size
- L2 Cache RAM: Lists the CPU L2 cache size
- Processor Core: Lists the number of the processor core
- Hyper-Threading: Indicates if the Intel Hyper-Threading Technology is supported by the CPU.

4.3.4 IDE Configuration

Use the **IDE Configuration** menu (**BIOS Menu 6**) to change and/or set the configuration of the SATA devices installed in the system.

TANK-101B/BW Embedded System

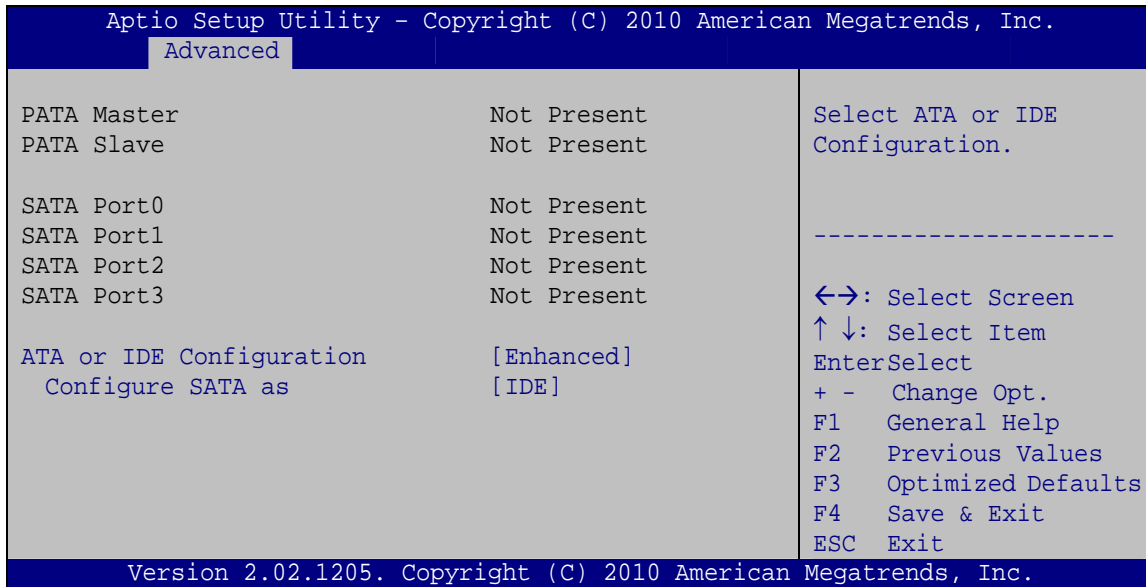

BIOS Menu 6: IDE Configuration

→ ATA or IDE Configuration [Enhanced]

Use the **ATA or IDE Configuration** option to configure the ATA/IDE controller.

- **Disabled** Disables the on-board ATA/IDE controller.
- **Compatible** Configures the on-board ATA/IDE controller to be in compatible mode. In this mode, a SATA channel will replace one of the IDE channels. This mode supports up to 4 storage devices.
- **Enhanced DEFAULT** Configures the on-board ATA/IDE controller to be in Enhanced mode. In this mode, IDE channels and SATA channels are separated. This mode supports up to 6 storage devices. Some legacy OS do not support this mode.

→ Configure SATA as [IDE]

Use the **Configure SATA as** option to configure SATA devices as normal IDE devices.

- **IDE DEFAULT** Configures SATA devices as normal IDE device.
- **AHCI** Configures SATA devices as AHCI device.

4.3.5 USB Configuration

Use the **USB Configuration** menu (**BIOS Menu 7**) to read USB configuration information and configure the USB settings.

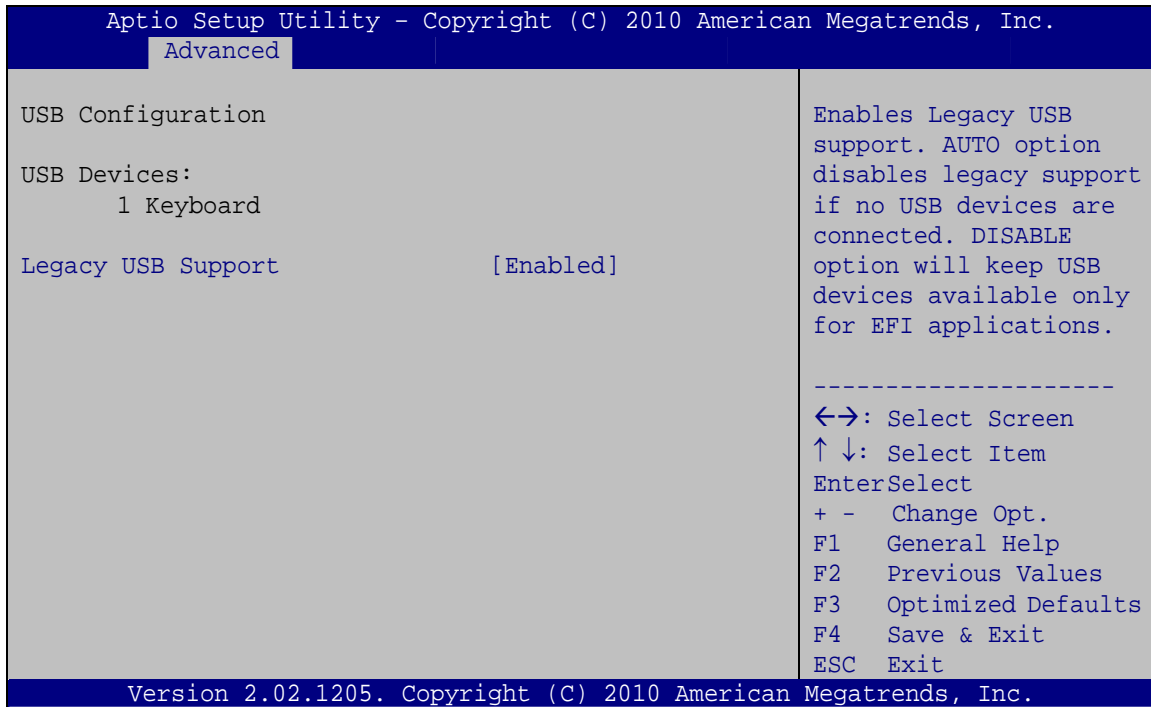

BIOS Menu 7: USB Configuration

➔ USB Devices

The **USB Devices** field lists the USB devices that are enabled on the system

➔ Legacy USB Support [Enabled]

Use the **Legacy USB Support** BIOS option to enable USB mouse and USB keyboard support. Normally if this option is not enabled, any attached USB mouse or USB keyboard does not become available until a USB compatible operating system is fully booted with all USB drivers loaded. When this option is enabled, any attached USB mouse or USB keyboard can control the system even when there is no USB driver loaded onto the system.

➔ **Enabled** **DEFAULT** Legacy USB support enabled

TANK-101B/BW Embedded System

- ➔ **Disabled** Legacy USB support disabled
- ➔ **Auto** Legacy USB support disabled if no USB devices are connected

4.3.6 Super IO Configuration

Use the **Super IO Configuration** menu (**BIOS Menu 8**) to set or change the configurations for the serial ports.

```

Aptio Setup Utility - Copyright (C) 2010 American Megatrends, Inc.
  Advanced
-----
Super IO Configuration
Super IO Chip              Finteck F81865
> Serial Port 1 Configuration
> Serial Port 2 Configuration
> Serial Port 3 Configuration
> Serial Port 4 Configuration

Set Parameters of Serial Port 1 (COMA)
-----
<=>: Select Screen
↑ ↓: Select Item
Enter>Select
+ - Change Opt.
F1  General Help
F2  Previous Values
F3  Optimized Defaults
F4  Save & Exit
ESC Exit

Version 2.02.1205. Copyright (C) 2010 American Megatrends, Inc.
  
```

BIOS Menu 8: Super IO Configuration

4.3.6.1 Serial Port n Configuration

Use the **Serial Port n Configuration** menu (**BIOS Menu 9**) to configure the serial port n.

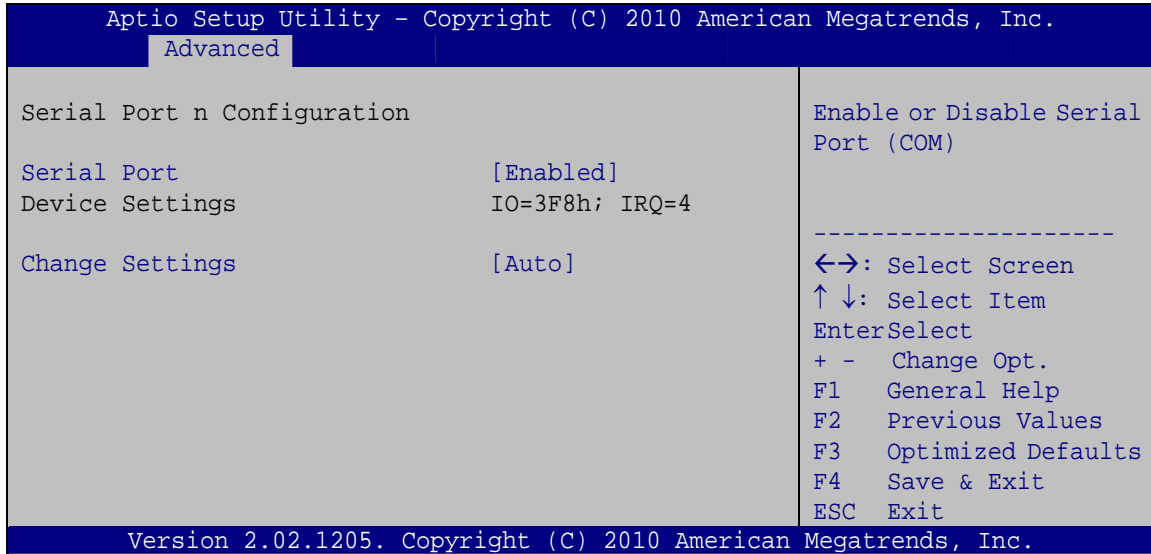

BIOS Menu 9: Serial Port n Configuration Menu

4.3.6.1.1 Serial Port 1 Configuration

→ Serial Port [Enabled]

Use the **Serial Port** option to enable or disable the serial port.

- **Disabled** Disable the serial port
- **Enabled** **DEFAULT** Enable the serial port

→ Change Settings [Auto]

Use the **Change Settings** option to change the serial port IO port address and interrupt address.

- **Auto** **DEFAULT** The serial port IO port address and interrupt address are automatically detected.
- **IO=3F8h;**
IRQ=4 Serial Port I/O port address is 3F8h and the interrupt address is IRQ4

TANK-101B/BW Embedded System

- ➔ **IO=3F8h;**
IRQ=3, 4 Serial Port I/O port address is 3F8h and the interrupt address is IRQ3, 4
- ➔ **IO=2F8h;**
IRQ=3, 4 Serial Port I/O port address is 2F8h and the interrupt address is IRQ3, 4
- ➔ **IO=2C0h;**
IRQ=3, 4 Serial Port I/O port address is 2C0h and the interrupt address is IRQ3, 4
- ➔ **IO=2C8h;**
IRQ=3, 4 Serial Port I/O port address is 2C8h and the interrupt address is IRQ3, 4

4.3.6.1.2 Serial Port 2 Configuration

➔ Serial Port [Enabled]

Use the **Serial Port** option to enable or disable the serial port.

- ➔ **Disabled** Disable the serial port
- ➔ **Enabled** **DEFAULT** Enable the serial port

➔ Change Settings [Auto]

Use the **Change Settings** option to change the serial port IO port address and interrupt address.

- ➔ **Auto** **DEFAULT** The serial port IO port address and interrupt address are automatically detected.
- ➔ **IO=2F8h;**
IRQ=3 Serial Port I/O port address is 2F8h and the interrupt address is IRQ3
- ➔ **IO=3F8h;**
IRQ=3, 4 Serial Port I/O port address is 3F8h and the interrupt address is IRQ3, 4
- ➔ **IO=2F8h;**
IRQ=3, 4 Serial Port I/O port address is 2F8h and the interrupt address is IRQ3, 4
- ➔ **IO=2C0h;**
IRQ=3, 4 Serial Port I/O port address is 2C0h and the interrupt address is IRQ3, 4

TANK-101B/BW Embedded System

4.3.6.1.4 Serial Port 4 Configuration

→ Serial Port [Enabled]

Use the **Serial Port** option to enable or disable the serial port.

- **Disabled** Disable the serial port
- **Enabled** **DEFAULT** Enable the serial port

→ Change Settings [Auto]

Use the **Change Settings** option to change the serial port IO port address and interrupt address.

- **Auto** **DEFAULT** The serial port IO port address and interrupt address are automatically detected.
- **IO=2E8h;**
IRQ=10 Serial Port I/O port address is 2E8h and the interrupt address is IRQ10
- **IO=3E8h;**
IRQ=10, 11 Serial Port I/O port address is 3E8h and the interrupt address is IRQ10, 11
- **IO=2E8h;**
IRQ=10, 11 Serial Port I/O port address is 2E8h and the interrupt address is IRQ10, 11
- **IO=2D0h;**
IRQ=10, 11 Serial Port I/O port address is 2D0h and the interrupt address is IRQ10, 11
- **IO=2D8h;**
IRQ=10, 11 Serial Port I/O port address is 2D8h and the interrupt address is IRQ10, 11

4.3.7 H/W Monitor

The **H/W Monitor** menu (**BIOS Menu 10**) shows the operating temperature, fan speeds and system voltages.

```

Aptio Setup Utility - Copyright (C) 2010 American Megatrends, Inc.
-----
Advanced
PC Health Status
CPU Temperature           :+45 C
SYS Temperature          :+40 C
CPU FAN Speed            :N/A
VCC3V                    :+3.312 V
V_core                   :+1.152 V
Vcc                      :+5.045 V
Vcc12                    :+12.056 V
Vcc1_5VDDR               :+1.488 V
VSB3V                    :+3.328 V
VBAT                     :+3.216 V
CPU Smart Fan control    [Auto Mode]
Temperature Bound 1      60
Temperature Bound 2      50
Temperature Bound 3      40
Temperature Bound 4      30
-----
<=>: Select Screen
↑ ↓: Select Item
Enter>Select
+ - Change Opt.
F1  General Help
F2  Previous Values
F3  Optimized Defaults
F4  Save & Exit
ESC Exit
Version 2.02.1205. Copyright (C) 2010 American Megatrends, Inc.
  
```

BIOS Menu 10: H/W Monitor

→ PC Health Status

The following system parameters and values are shown. The system parameters that are monitored are:

- System Temperatures:
 - CPU Temperature
 - System Temperature
- Fan Speeds:
 - CPU Fan Speed
- Voltages:
 - VCC3V
 - Vcore
 - Vcc
 - Vcc12

TANK-101B/BW Embedded System

- Vcc1_5VDDR
- VSB3V
- VBAT

→ CPU Smart Fan control [Auto Mode]

Use the **CPU Smart Fan control** option to configure the CPU fan.

- **Auto Mode** **DEFAULT** The fan adjusts its speed using these settings:
 - Temperature Bound 1
 - Temperature Bound 2
 - Temperature Bound 3
 - Temperature Bound 4

- **Manual Mode** The fan spins at the speed set in:
 - Manual Duty Cycle Setting

→ Temperature Bound n

Use the + or – key to change the fan **Temperature Bound n** value. Enter a decimal number between 0 and 127.

4.3.8 Serial Port Console Redirection

The **Serial Port Console Redirection** menu (**BIOS Menu 11**) allows the console redirection options to be configured. Console redirection allows users to maintain a system remotely by re-directing keyboard input and text output through the serial port.

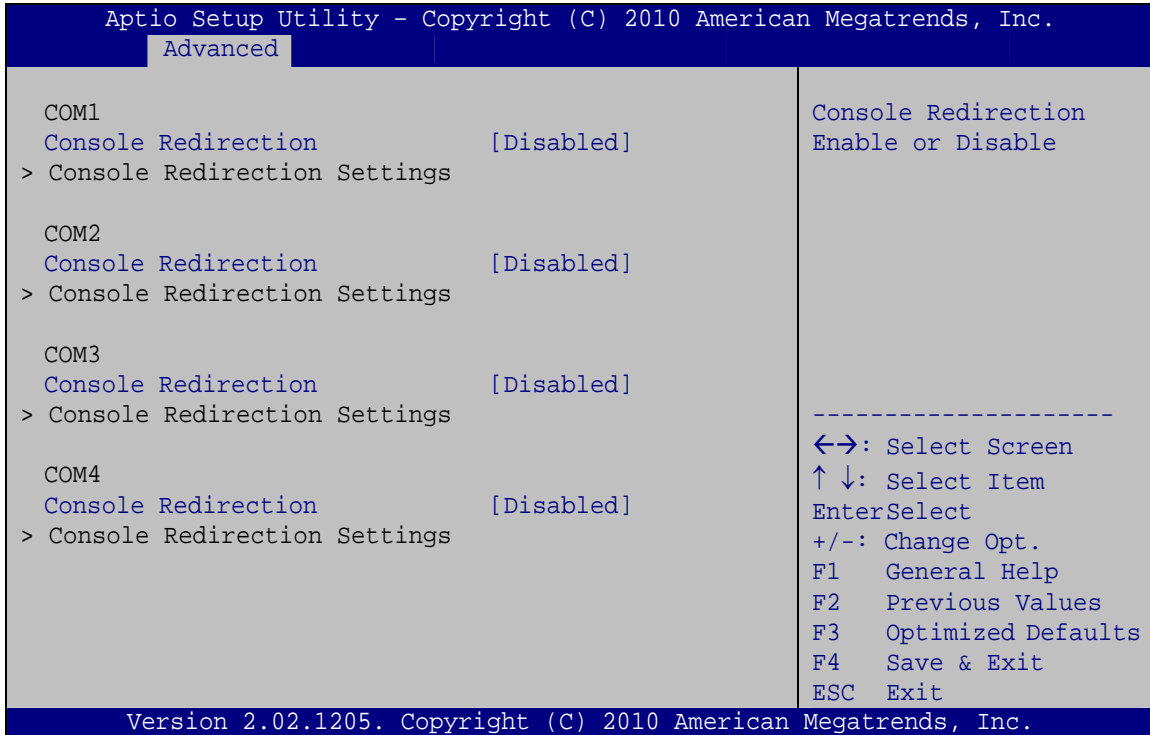

BIOS Menu 11: Serial Port Console Redirection

→ Console Redirection [Disabled]

Use **Console Redirection** option to enable or disable the console redirection function.

- **Disabled** **DEFAULT** Disabled the console redirection function
- **Enabled** Enabled the console redirection function

→ Terminal Type [ANSI]

Use the **Terminal Type** option to specify the remote terminal type.

- **VT100** The target terminal type is VT100
- **VT100+** The target terminal type is VT100+
- **VT-UTF8** The target terminal type is VT-UTF8
- **ANSI** **DEFAULT** The target terminal type is ANSI

TANK-101B/BW Embedded System

→ Bits per second [115200]

Use the **Bits per second** option to specify the serial port transmission speed. The speed must match the other side. Long or noisy lines may require lower speeds.

- **9600** Sets the serial port transmission speed at 9600.
- **19200** Sets the serial port transmission speed at 19200.
- **38400** Sets the serial port transmission speed at 38400.
- **57600** Sets the serial port transmission speed at 57600.
- **115200** **DEFAULT** Sets the serial port transmission speed at 115200.

4.4 Chipset

Use the **Chipset** menu (**BIOS Menu 12**) to access the Northbridge and Southbridge configuration menus.



WARNING!

Setting the wrong values for the Chipset BIOS selections in the Chipset BIOS menu may cause the system to malfunction.

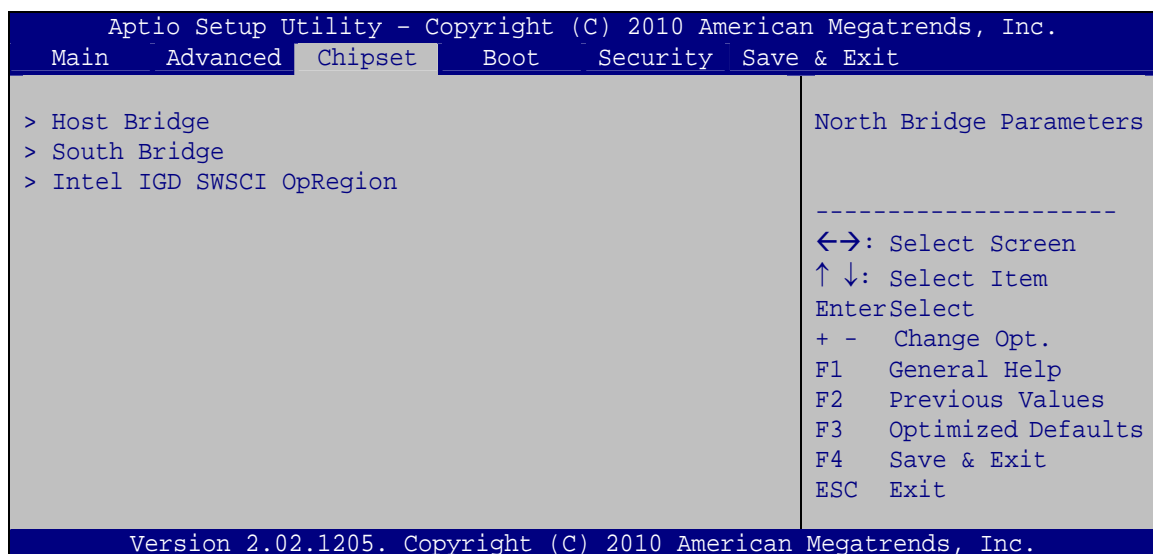

BIOS Menu 12: Chipset

4.4.1 Host Bridge Configuration

Use the **Host Bridge Configuration** menu (**BIOS Menu 13**) to configure the Northbridge chipset.

```

Aptio Setup Utility - Copyright (C) 2010 American Megatrends, Inc.
Chipset
> OnChip VGA Configuration                               Config On Chip VGA
                                                         Settings.
Initiate Graphic Adapter                               [PCI/IGD]
***** Memory Information *****
Memory Frequency                                     800 Mhz
Total Memory                                         1024 MB
DIMM#0                                               1024 MB
DIMM#1                                               Not Present
-----
<=>: Select Screen
↑↓: Select Item
EnterSelect
+ - Change Opt.
F1 General Help
F2 Previous Values
F3 Optimized Defaults
F4 Save & Exit
ESC Exit
Version 2.02.1205. Copyright (C) 2010 American Megatrends, Inc.

```

BIOS Menu 13: Host Bridge Chipset Configuration

→ Initiate Graphic Adapter [PCI/IGD]

Use the **Initiate Graphic Adapter** option to select the graphics controller used as the primary boot device. Select either an integrated graphics controller (IGD) or a combination of PCI graphics controller. Configuration options are listed below:

- IGD
- PCI/IGD **DEFAULT**

TANK-101B/BW Embedded System

4.4.1.1 OnChip VGA Configuration

Use the **OnChip VGA Configuration** menu (**BIOS Menu 14**) to configure the OnChip VGA.

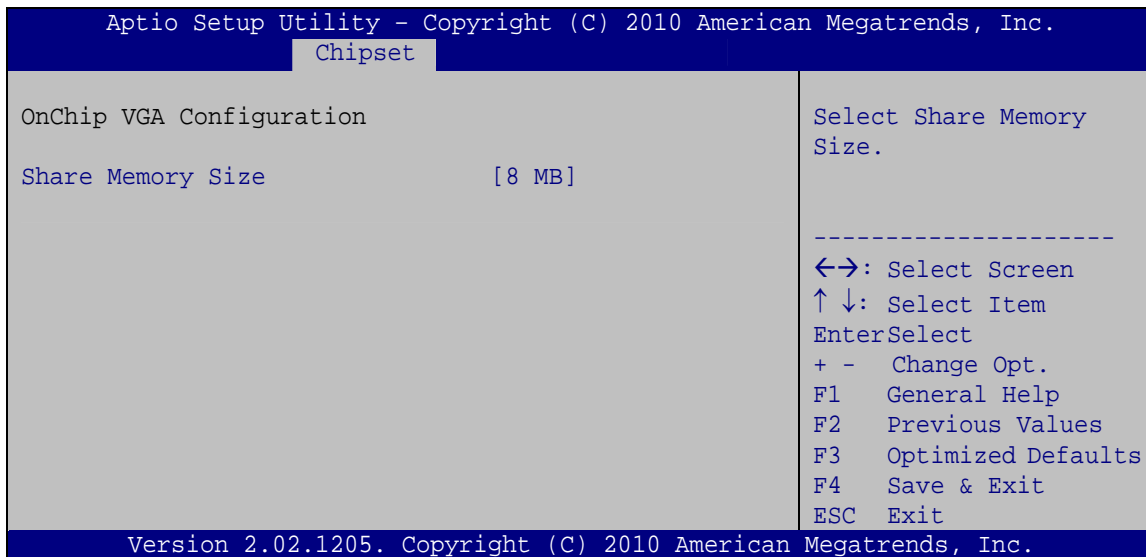

BIOS Menu 14: OnChip VGA Configuration

→ Share Memory Size [8 MB]

Use the **Share Memory Size** option to set the amount of system memory allocated to the integrated graphics processor when the system boots. The system memory allocated can then only be used as graphics memory, and is no longer available to applications or the operating system. Configuration options are listed below:

- Disabled
- 8 MB **Default**

4.4.2 South Bridge Configuration

Use the **South Bridge Configuration** menu (**BIOS Menu 15**) to configure the Southbridge chipset.

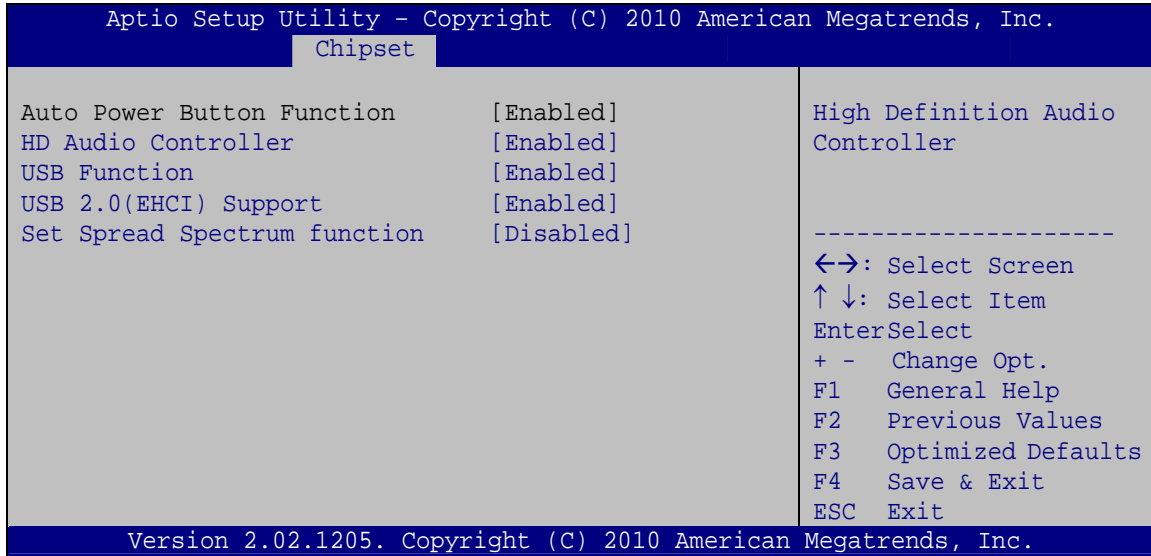

BIOS Menu 15: South Bridge Chipset Configuration

→ Restore AC Power Loss [Last State]

Use the **Restore AC Power Loss** BIOS option to specify what state the system returns to if there is a sudden loss of power to the system.

- **Power Off** The system remains turned off
- **Power On** The system turns on
- **Last State** **DEFAULT** The system returns to its previous state. If it was on, it turns itself on. If it was off, it remains off.

→ HD Audio Controller [Enabled]

Use the **HD Audio Controller** option to enable or disable the High Definition Audio controller.

- **Enabled** **DEFAULT** The onboard High Definition Audio controller automatically detected and enabled
- **Disabled** The onboard High Definition Audio controller is disabled

→ USB Function [Enabled]

Use the **USB Function** BIOS option to enable or disable USB function support.

TANK-101B/BW Embedded System

- ➔ Disabled USB function support disabled
- ➔ Enabled DEFAULT USB function support enabled

➔ USB 2.0 (EHCI) Support [Enabled]

Use the **USB 2.0 (EHCI) Support** BIOS option to enable or disable USB 2.0 support.

- ➔ Enabled DEFAULT USB 2.0 (EHCI) support enabled
- ➔ Disabled USB 2.0 (EHCI) support disabled

➔ Set Spread Spectrum Function [Disabled]

The **Set Spread Spectrum Function** option can help to improve CPU EMI issues.

- ➔ Disabled DEFAULT The spread spectrum mode is disabled
- ➔ Enabled The spread spectrum mode is enabled

4.4.3 Intel IGD SWSCI OpRegion

Use the **Intel IGD SWSCI OpRegion** menu (**BIOS Menu 16**) to configure the video device connected to the system.

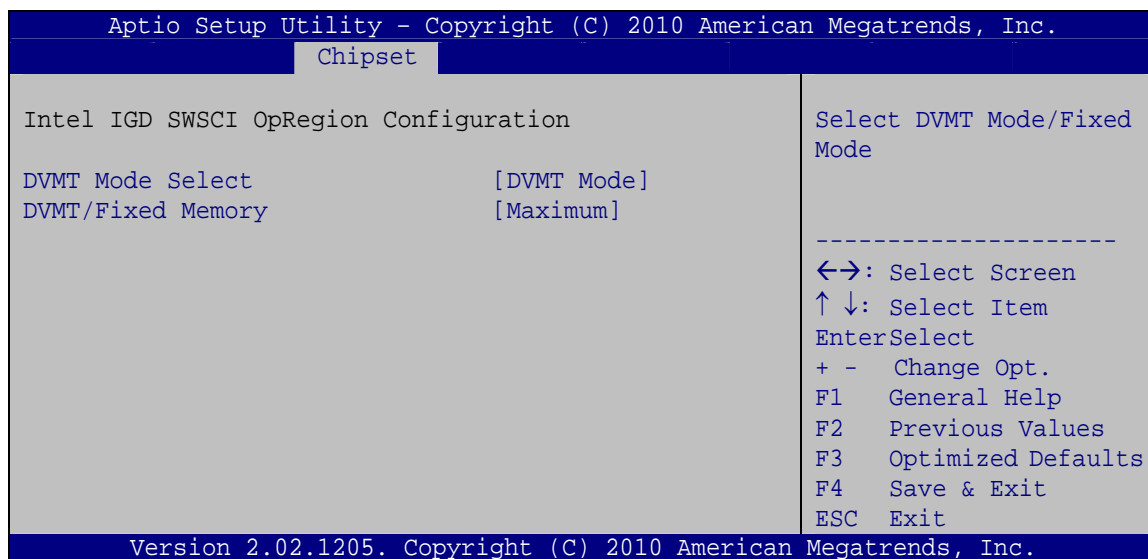

BIOS Menu 16: Intel IGD SWSCI OpRegion Configuration

→ DVMT Mode Select [DVMT Mode]

Use the **DVMT Mode Select** option to select the Intel Dynamic Video Memory Technology (DVMT) operating mode.

- **Fixed Mode** A fixed portion of graphics memory is reserved as graphics memory.
- **DVMT Mode** **DEFAULT** Graphics memory is dynamically allocated according to the system and graphics needs.

→ DVMT/FIXED Memory [Maximum]

Use the **DVMT/FIXED Memory** option to specify the maximum amount of memory that can be allocated as graphics memory. Configuration options are listed below.

- 128 MB
- 256 MB
- Maximum **Default**

4.5 Boot

Use the **Boot** menu (**BIOS Menu 17**) to configure system boot options.

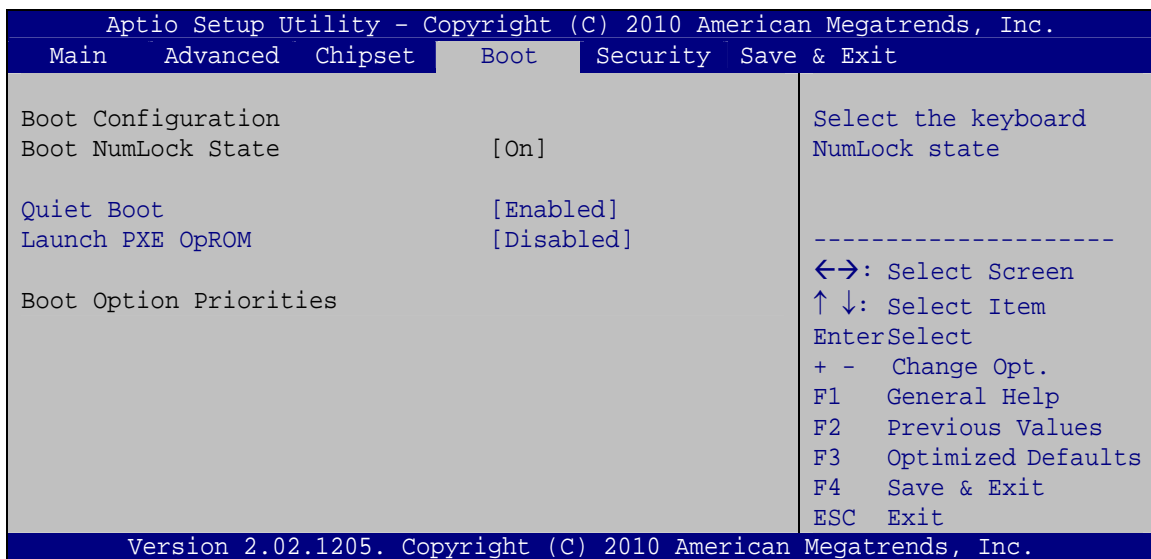

BIOS Menu 17: Boot

TANK-101B/BW Embedded System

→ **Bootup NumLock State [On]**

Use the **Bootup NumLock State** BIOS option to specify if the number lock setting must be modified during boot up.

- **On** **DEFAULT** Allows the Number Lock on the keyboard to be enabled automatically when the computer system boots up. This allows the immediate use of the 10-key numeric keypad located on the right side of the keyboard. To confirm this, the Number Lock LED light on the keyboard is lit.

- **Off** Does not enable the keyboard Number Lock automatically. To use the 10-keys on the keyboard, press the Number Lock key located on the upper left-hand corner of the 10-key pad. The Number Lock LED on the keyboard lights up when the Number Lock is engaged.

→ **Quiet Boot [Enabled]**

Use the **Quiet Boot** BIOS option to select the screen display when the system boots.

- **Disabled** Normal POST messages displayed

- **Enabled** **DEFAULT** OEM Logo displayed instead of POST messages

→ **Launch PXE OpROM [Disabled]**

Use the **Launch PXE OpROM** option to enable or disable boot option for legacy network devices.

- **Disabled** **DEFAULT** Ignore all PXE Option ROMs

- **Enabled** Load PXE Option ROMs.

4.6 Security

Use the **Security** menu (**BIOS Menu 18**) to set system and user passwords.

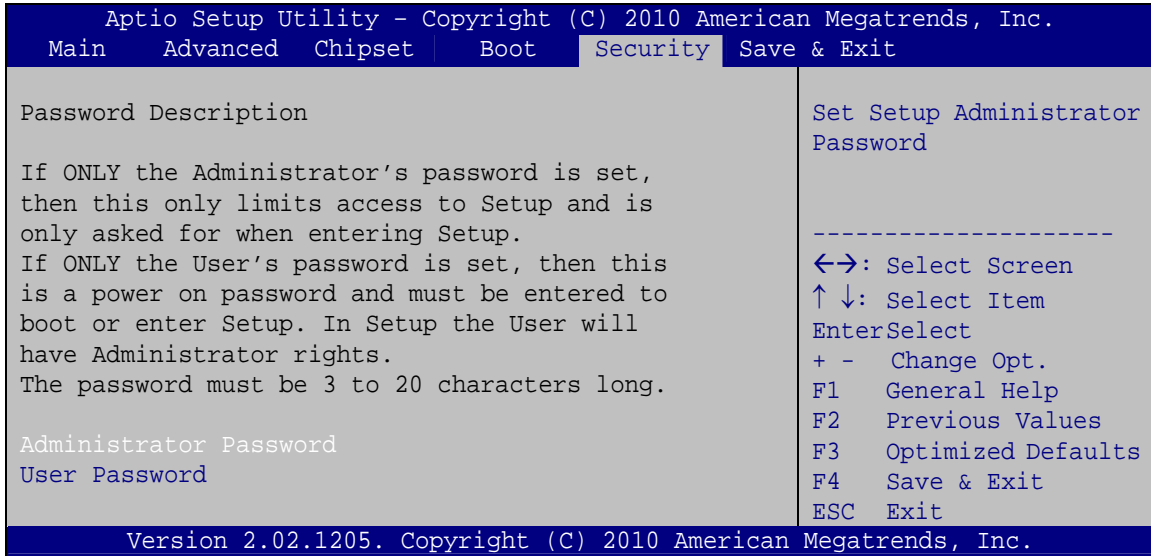
BIOS Menu 18: Security
→ Administrator Password

Use the **Administrator Password** to set or change a administrator password.

→ User Password

Use the **User Password** to set or change a user password.

TANK-101B/BW Embedded System

4.7 Exit

Use the **Exit** menu (**BIOS Menu 19**) to load default BIOS values, optimal failsafe values and to save configuration changes.

```

Aptio Setup Utility - Copyright (C) 2010 American Megatrends, Inc.
Main   Advanced  Chipset  Boot   Security  Save & Exit
-----
Save Changes and Reset
Discard Changes and Reset

Restore Defaults
Save as User Defaults
Restore User Defaults

Exit the system after
saving the changes.

-----
<->: Select Screen
↑ ↓: Select Item
Enter>Select
+ -  Change Opt.
F1   General Help
F2   Previous Values
F3   Optimized Defaults
F4   Save & Exit
ESC  Exit

Version 2.02.1205. Copyright (C) 2010 American Megatrends, Inc.
  
```

BIOS Menu 19:Exit

→ Save Changes and Reset

Use the **Save Changes and Reset** option to save the changes made to the BIOS options and to exit the BIOS configuration setup program.

→ Discard Changes and Reset

Use the **Discard Changes and Reset** option to exit the system without saving the changes made to the BIOS configuration setup program.

→ Restore Defaults

Use the **Restore Defaults** option to load the optimal default values for each of the parameters on the Setup menus. **F3 key can be used for this operation.**



→ **Save as User Defaults**

Use the **Save as User Defaults** option to save the changes done so far as user defaults.

→ **Restore User Defaults**

Use the **Restore User Defaults** option to restore the user defaults to all the setup options.

Appendix

A

One Key Recovery

A.1 One Key Recovery Introduction

The IEI one key recovery is an easy-to-use front end for the Norton Ghost system backup and recovery tool. This tool provides quick and easy shortcuts for creating a backup and reverting to that backup or reverting to the factory default settings.



NOTE:

The latest One Key Recovery software provides an auto recovery function that allows a system running Microsoft Windows OS to automatically restore from the factory default image after encountering a Blue Screen of Death (BSoD) or a hang for around 10 minutes. Please refer to Section A.3 for the detailed setup procedure.

The IEI One Key Recovery tool menu is shown below.

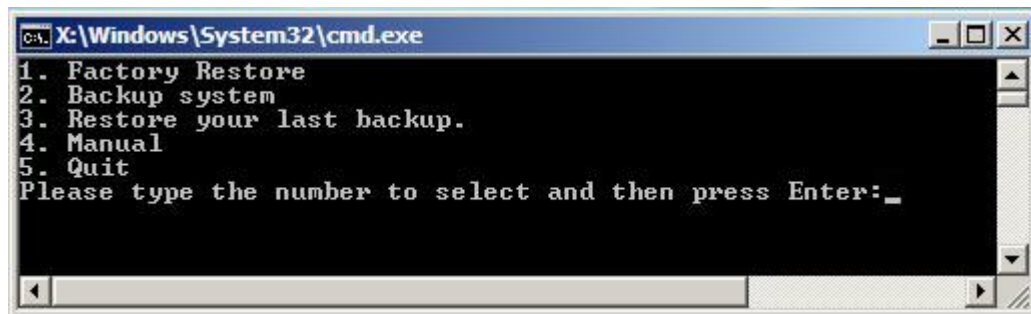

```

C:\X:\Windows\System32\cmd.exe
1. Factory Restore
2. Backup system
3. Restore your last backup.
4. Manual
5. Quit
Please type the number to select and then press Enter: _
  
```

Figure A-1: IEI One Key Recovery Tool Menu

Prior to using the IEI One Key Recovery tool (as shown in **Figure A-1**) to backup or restore Windows system, five setup procedures are required.

1. Hardware and BIOS setup (see Section **A.2.1**)
2. Create partitions (see **Section A.2.2**)
3. Install operating system, drivers and system applications (see **Section A.2.3**)
4. Build the recovery partition (see **Section A.2.4**)
5. Create factory default image (see **Section A.2.5**)

TANK-101B/BW Embedded System

After completing the five initial setup procedures as described above, users can access the recovery tool by pressing <F3> while booting up the system. The detailed information of each function is described in **Section A.5**.



NOTE:

The initial setup procedures for Linux system are described in **Section A.3**.

A.1.1 System Requirement



NOTE:

The recovery CD can only be used with IEI products. The software will fail to run and a warning message will appear when used on non-IEI hardware.

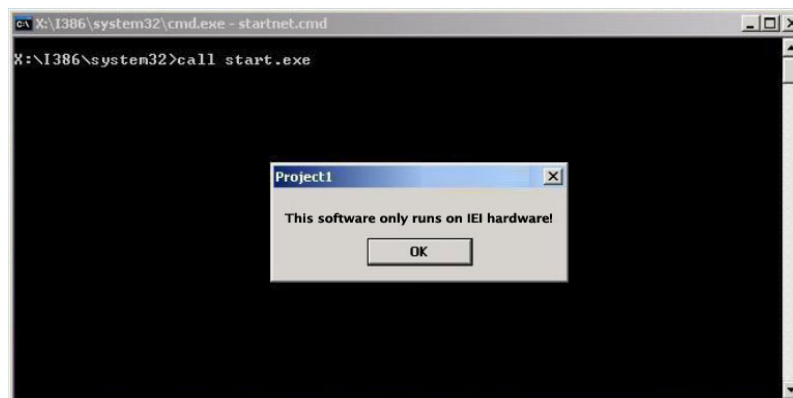

To create the system backup, the main storage device must be split into two partitions (three partitions for Linux). The first partition will be for the operating system, while the second partition will be invisible to the operating system and contain the backup made by the one key recovery software.

The partition created for recovery images must be big enough to contain both the factory default image and the user backup image. The size must be calculated before creating the

partitions. Please take the following table as a reference when calculating the size of the partition.

	OS	OS Image after Ghost	Compression Ratio
Windows® 7	7 GB	5 GB	70%
Windows® XPE	776 MB	560 MB	70%
Windows® CE 6.0	36 MB	28 MB	77%

NOTE:

Specialized tools are required to change the partition size if the operating system is already installed.

A.1.2 Supported Operating System

The recovery CD is compatible with both Microsoft Windows and Linux operating system (OS). The supported OS versions are listed below.

- Microsoft Windows
 - Windows XP (Service Pack 2 or 3 required)
 - Windows Vista
 - Windows 7
 - Windows CE 5.0
 - Windows CE 6.0
 - Windows XP Embedded
- Linux
 - Fedora Core 12 (Constantine)
 - Fedora Core 11 (Leonidas)
 - Fedora Core 10 (Cambridge)
 - Fedora Core 8 (Werewolf)
 - Fedora Core 7 (Moonshine)
 - RedHat RHEL-5.4
 - RedHat 9 (Ghirke)

TANK-101B/BW Embedded System

- Ubuntu 8.10 (Intrepid)
- Ubuntu 7.10 (Gutsy)
- Ubuntu 6.10 (Edgy)
- Debian 5.0 (Lenny)
- Debian 4.0 (Etch)
- SuSe 11.2
- SuSe 10.3



NOTE:

Installing unsupported OS versions may cause the recovery tool to fail.

A.2 Setup Procedure for Windows

Prior to using the recovery tool to backup or restore Windows system, a few setup procedures are required.

Step 1: Hardware and BIOS setup (see Section **A.2.1**)

Step 2: Create partitions (see **Section A.2.2**)

Step 3: Install operating system, drivers and system applications (see **Section A.2.3**)

Step 4: Build the recovery partition (see **Section A.2.4**) or build the auto recovery partition (see **Section A.3**)

Step 5: Create factory default image (see **Section A.2.5**)

The detailed descriptions are described in the following sections.



NOTE:

The setup procedures described below are for Microsoft Windows operating system users. For Linux, most of the setup procedures are the same except for several steps described in **Section A.3**.

A.2.1 Hardware and BIOS Setup

- Step 1:** Make sure the system is powered off and unplugged.
- Step 2:** Install a hard drive or SSD in the system. An unformatted and unpartitioned disk is recommended.
- Step 3:** Connect an optical disk drive to the system and insert the recovery CD.
- Step 4:** Turn on the system.
- Step 5:** Press the <DELETE> key as soon as the system is turned on to enter the BIOS.
- Step 6:** Select the connected optical disk drive as the 1st boot device. (**Boot → Boot Device Priority → 1st Boot Device**).
- Step 7:** Save changes and restart the computer. Continue to the next section for instructions on partitioning the internal storage.

A.2.2 Create Partitions

To create the system backup, the main storage device must be split into two partitions (three partitions for Linux). The first partition will be for the operating system, while the second partition will be invisible to the operating system and contain the backup made by the one key recovery software.

- Step 1:** Put the recovery CD in the optical drive of the system.
- Step 2:** **Boot the system from recovery CD.** When prompted, press any key to boot from the recovery CD. It will take a while to launch the recovery tool. Please be patient!

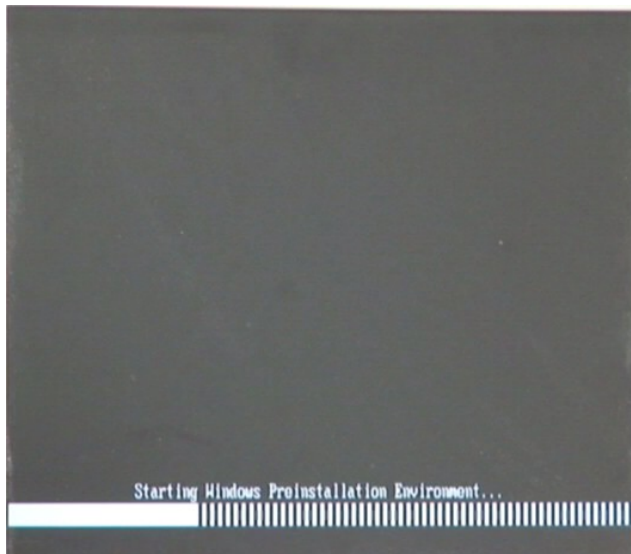

Figure A-2: Launching the Recovery Tool

Step 3: The recovery tool setup menu is shown as below.

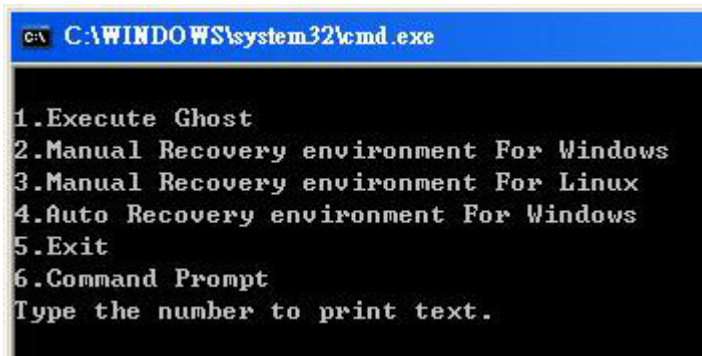
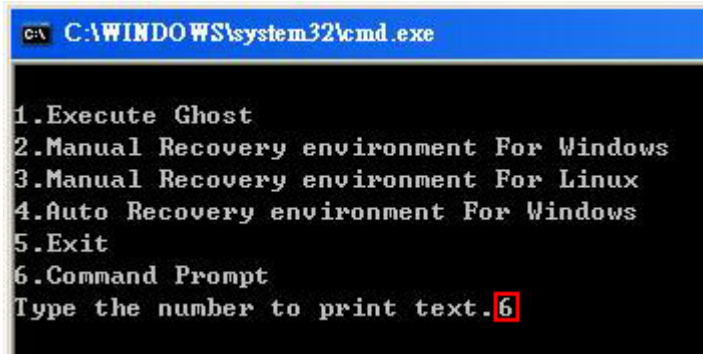

Figure A-3: Recovery Tool Setup Menu

Step 4: Press <6> then <Enter>.



```

C:\WINDOWS\system32\cmd.exe

1.Execute Ghost
2.Manual Recovery environment For Windows
3.Manual Recovery environment For Linux
4.Auto Recovery environment For Windows
5.Exit
6.Command Prompt
Type the number to print text.6
  
```

Figure A-4: Command Mode

Step 5: The command prompt window appears. Type the following commands (marked in red) to create two partitions. One is for the OS installation; the other is for saving recovery files and images which will be an invisible partition. (Press <Enter> after entering each line below)

```

system32>diskpart
DISKPART>list vol
DISKPART>sel disk 0
DISKPART>create part pri size= ____
DISKPART>assign letter=N
DISKPART>create part pri size= ____
DISKPART>assign letter=F
DISKPART>exit
system32>format N: /fs:ntfs /q /y
system32>format F: /fs:ntfs /q /v:Recovery /y
system32>exit
  
```



```

X:\I386\SYSTEM32\CMD.EXE
X:\I386\SYSTEM32>diskpart → Starts the Microsoft disk partitioning tool.

Microsoft DiskPart version 5.2.3790.1830
Copyright (C) 1999-2001 Microsoft Corporation.
On computer: MININT-JUC

DISKPART> list vol → Show partition information

   Volume ###  Ltr  Label          Fs          Type          Size         Status       Info
   -----  -  -  -  -  -  -  -  -  -  -
   Volume 0             X  CD_ROM         CDFS        DUD-ROM        405 MB     Healthy      Boot
   Volume 1             D                FAT32        Removeable    3854 MB     Healthy

DISKPART> sel disk 0 → Select a disk
Disk 0 is now the selected disk.

DISKPART> create part pri size=2000 → Create partition 1 and assign a size.
                                     This partition is for OS installation.
DiskPart succeeded in creating the specified partition.

DISKPART> assign letter=N → Assign partition 1 a code name (N).
DiskPart successfully assigned the drive letter or mount point.

DISKPART> create part pri size=1800 → Create partition 2 and assign a size.
                                     This partition is for recovery images.
DiskPart succeeded in creating the specified partition.

DISKPART> assign letter=F → Assign partition 2 a code name (F).
DiskPart successfully assigned the drive letter or mount point.

DISKPART> exit → Exit diskpart

X:\I386\SYSTEM32>format n: /fs:ntfs /q /y → Format partition 1 (N) as NTFS format.
The type of the file system is RAW.
The new file system is NTFS.
QuickFormatting 2000M
Creating file system structures.
Format complete.
 2048254 KB total disk space.
 2035620 KB are available.

X:\I386\SYSTEM32>format f: /fs:ntfs /q /v:Recovery /y
The type of the file system is RAW.
The new file system is NTFS.
QuickFormatting 1804M
Creating file system structures.
Format complete.
 1847474 KB total disk space.
 1835860 KB are available.

X:\I386\SYSTEM32>exit → Exit Windows PE
  
```

Figure A-5: Partition Creation Commands

**NOTE:**

Use the following commands to check if the partitions were created successfully.

```
X:\I386\SYSTEM32>diskpart
Microsoft DiskPart version 5.2.3790.1830
Copyright (C) 1999-2001 Microsoft Corporation.
On computer: MININT-JUC

DISKPART> sel disk 0
Disk 0 is now the selected disk.

DISKPART> list part

   Partition ###   Type              Size              Offset
-----
   Partition 1     Primary            2000 MB            32 KB
   Partition 2     Primary            1804 MB           2000 MB

DISKPART> exit
```

Step 6: Press any key to exit the recovery tool and automatically reboot the system.

Please continue to the following procedure: Build-up Recovery Partition.

A.2.3 Install Operating System, Drivers and Applications

Install the operating system onto the unlabelled partition. The partition labeled "Recovery" is for use by the system recovery tool and should not be used for installing the operating system or any applications.

**NOTE:**

The operating system installation program may offer to reformat the chosen partition. DO NOT format the partition again. The partition has already been formatted and is ready for installing the new operating system.

To install the operating system, insert the operating system installation CD into the optical drive. Restart the computer and follow the installation instructions.

TANK-101B/BW Embedded System

A.2.4 Build-up Recovery Partition

- Step 1:** Put the recover CD in the optical drive.
- Step 2:** Start the system.
- Step 3:** **Boot the system from recovery CD.** When prompted, press any key to boot from the recovery CD. It will take a while to launch the recovery tool. Please be patient!

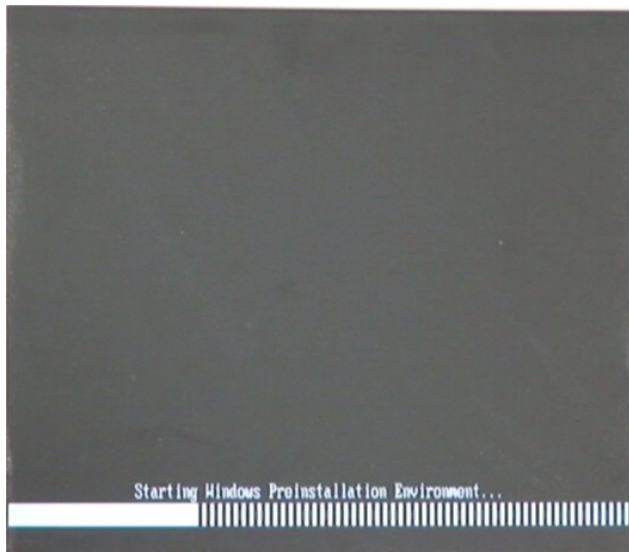

Figure A-6: Launching the Recovery Tool

- Step 4:** When the recovery tool setup menu appears, press <2> then <Enter>.

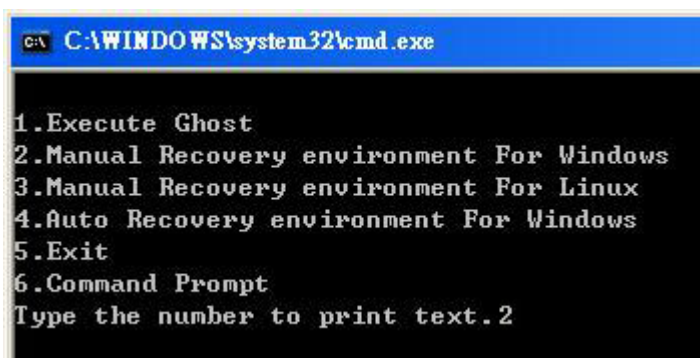

Figure A-7: System Configuration for Windows

Step 5: The Symantec Ghost window appears and starts configuring the system to build a recovery partition. In this process the partition created for recovery files in **Section A.2.2** is hidden and the recovery tool is saved in this partition.

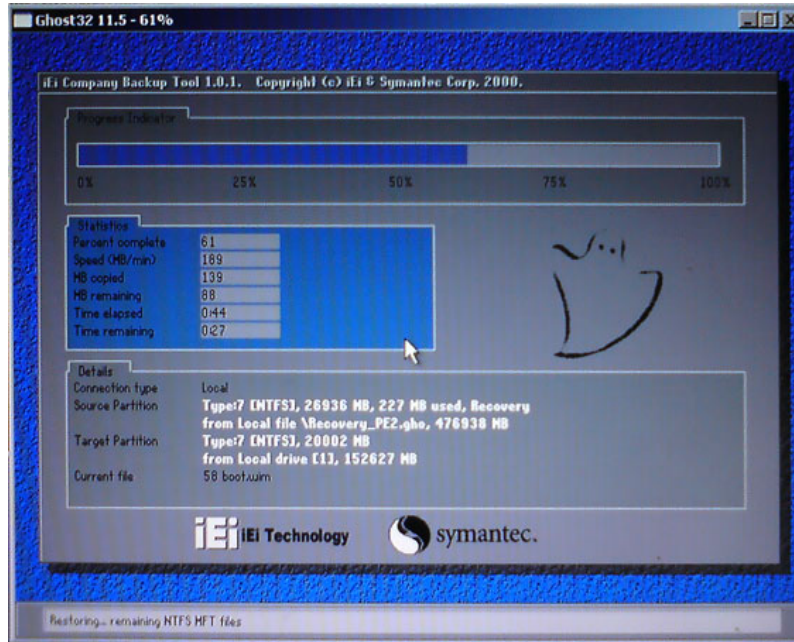

Figure A-8: Building the Recovery Partition

Step 6: After completing the system configuration, press any key in the following window to reboot the system.

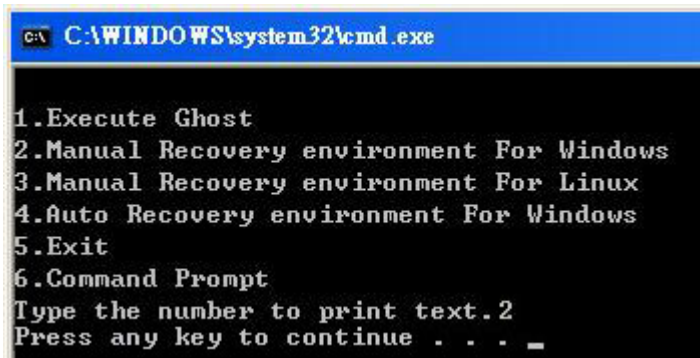

Figure A-9: Press Any Key to Continue

Step 7: Eject the recovery CD.

TANK-101B/BW Embedded System

A.2.5 Create Factory Default Image



NOTE:

Before creating the factory default image, please configure the system to a factory default environment, including driver and application installations.

To create a factory default image, please follow the steps below.

Step 1: Turn on the system. When the following screen displays (**Figure A-10**), press the <F3> key to access the recovery tool. The message will display for 10 seconds, please press F3 before the system boots into the operating system.

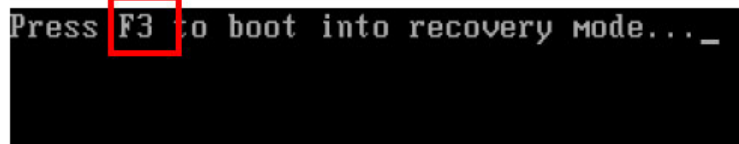

```
Press F3 to boot into recovery mode... _
```

Figure A-10: Press F3 to Boot into Recovery Mode

Step 2: The recovery tool menu appears. Type <4> and press <Enter>. (**Figure A-11**)

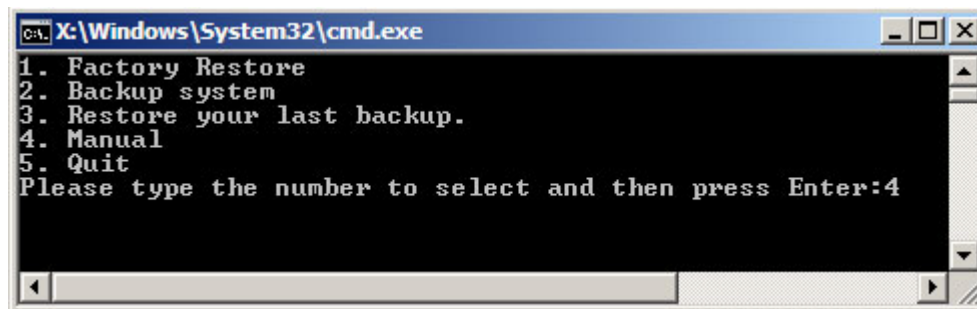

Figure A-11: Recovery Tool Menu

Step 3: The About Symantec Ghost window appears. Click **OK** button to continue.

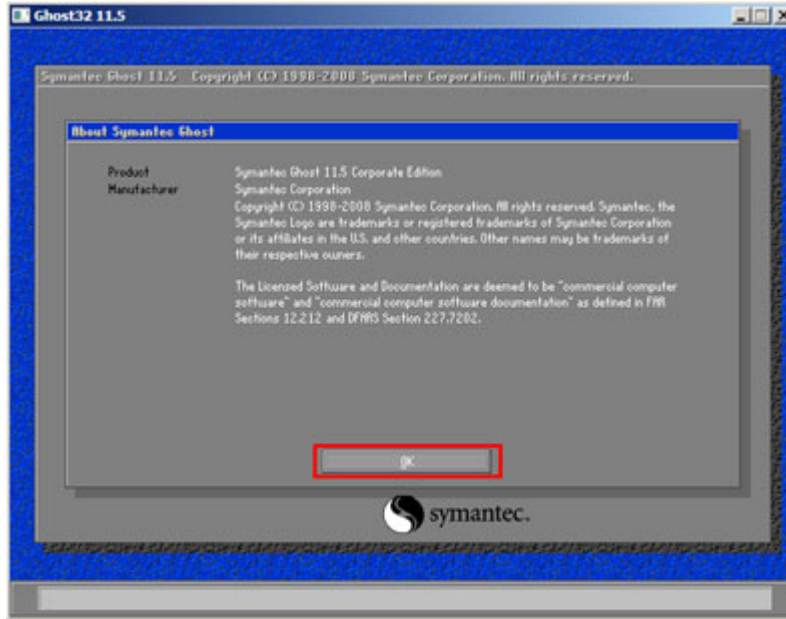

Figure A-12: About Symantec Ghost Window

Step 4: Use mouse to navigate to the option shown below (Figure A-13).

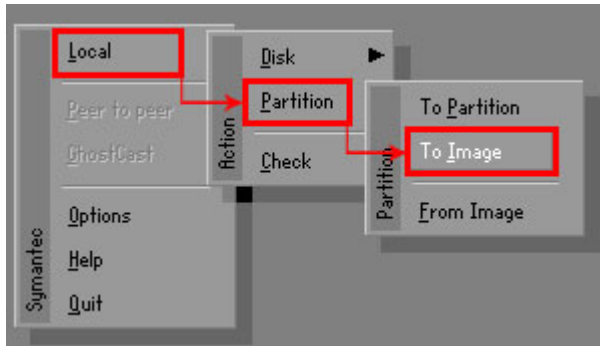

Figure A-13: Symantec Ghost Path

Step 5: Select the local source drive (Drive 1) as shown in Figure A-14. Then click OK.

TANK-101B/BW Embedded System

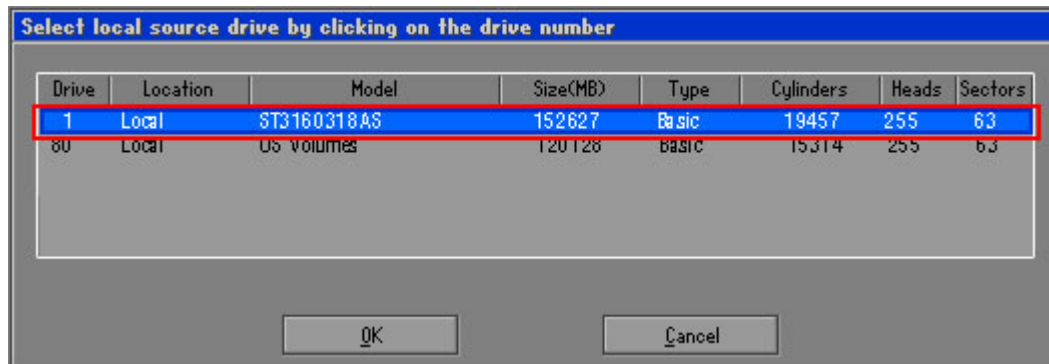

Figure A-14: Select a Local Source Drive

Step 6: Select a source partition (Part 1) from basic drive as shown in **Figure A-15**. Then click OK.

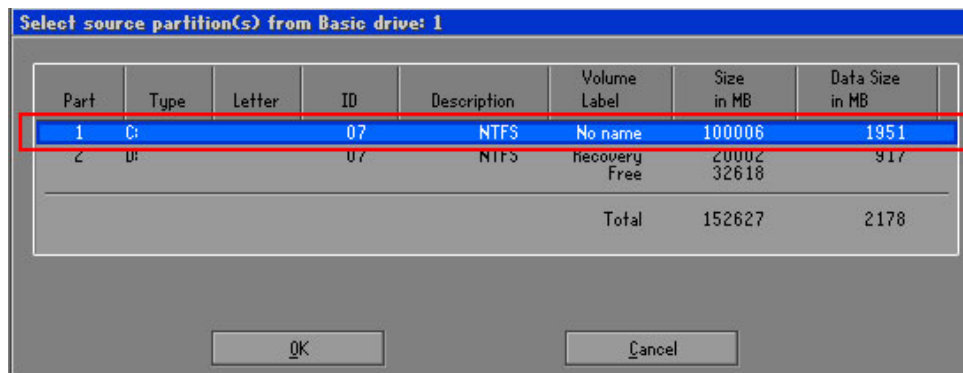

Figure A-15: Select a Source Partition from Basic Drive

Step 7: Select **1.2: [Recovery] NTFS drive** and enter a file name called **iei** (**Figure A-16**). Click **Save**. The factory default image will then be saved in the selected recovery drive and named **IEI.GHO**.



WARNING:

The file name of the factory default image must be **iei.GHO**.

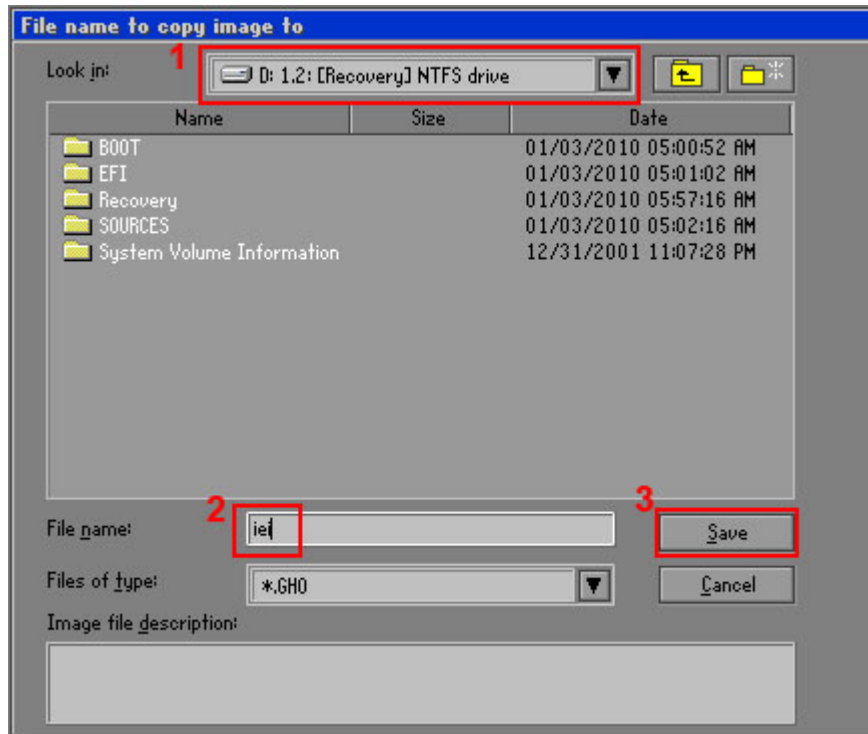

Figure A-16: File Name to Copy Image to

Step 8: When the Compress Image screen in **Figure A-17** prompts, click **High** to make the image file smaller.

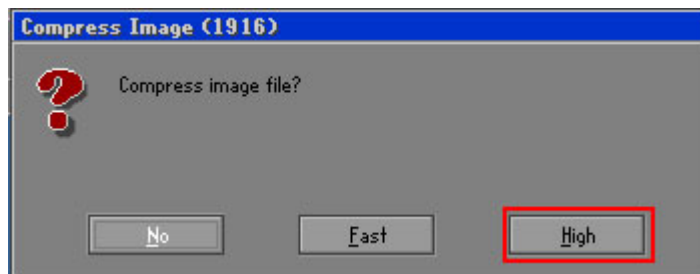

Figure A-17: Compress Image

TANK-101B/BW Embedded System

Step 9: The Proceed with partition image creation window appears, click **Yes** to continue.

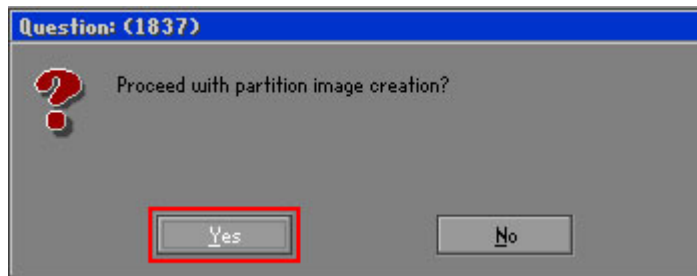

Figure A-18: Image Creation Confirmation

Step 10: The Symantec Ghost starts to create the factory default image (**Figure A-19**).

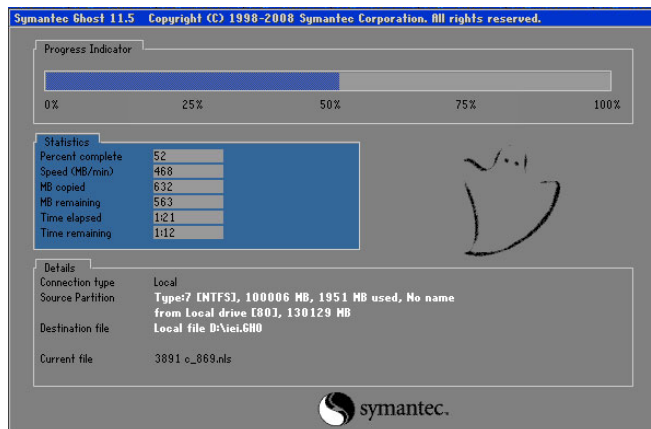

Figure A-19: Image Creation Process

Step 11: When the image creation completes, a screen prompts as shown in **Figure A-20**.

Click **Continue** and close the Ghost window to exit the program.



Figure A-20: Image Creation Complete

Step 12: The recovery tool main menu window is shown as below. Press any key to reboot the system.

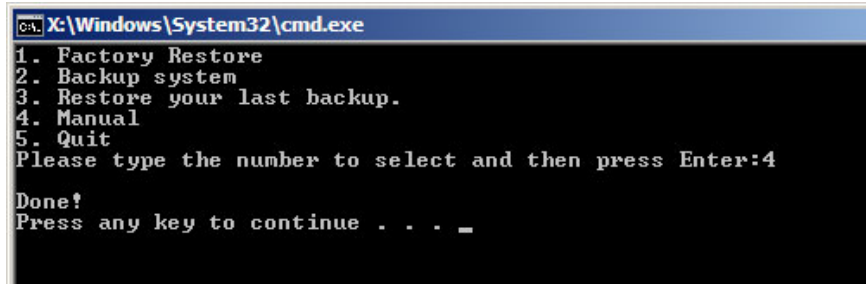

```

C:\Windows\System32\cmd.exe
1. Factory Restore
2. Backup system
3. Restore your last backup.
4. Manual
5. Quit
Please type the number to select and then press Enter:4
Done!
Press any key to continue . . . _
  
```

Figure A-21: Press Any Key to Continue

A.3 Auto Recovery Setup Procedure

The auto recovery function allows a system to automatically restore from the factory default image after encountering a Blue Screen of Death (BSoD) or a hang for around 10 minutes. To use the auto recovery function, follow the steps described in the following sections.



CAUTION:

The setup procedure may include a step to create a factory default image. It is suggested to configure the system to a factory default environment before the configuration, including driver and application installations.

Step 1: Follow the steps described in **Section A.2.1 ~ Section A.2.3** to setup BIOS, create partitions and install operating system.

Step 2: Install the auto recovery utility into the system by double clicking the **Utility/AUTORECOVERY-SETUP.exe** in the One Key Recovery CD. This utility **MUST** be installed in the system, otherwise, the system will automatically restore from the factory default image every ten (10) minutes.

TANK-101B/BW Embedded System



Figure A-22: Auto Recovery Utility

Step 3: Reboot the system from the recovery CD. When prompted, press any key to boot from the recovery CD. It will take a while to launch the recovery tool. Please be patient!

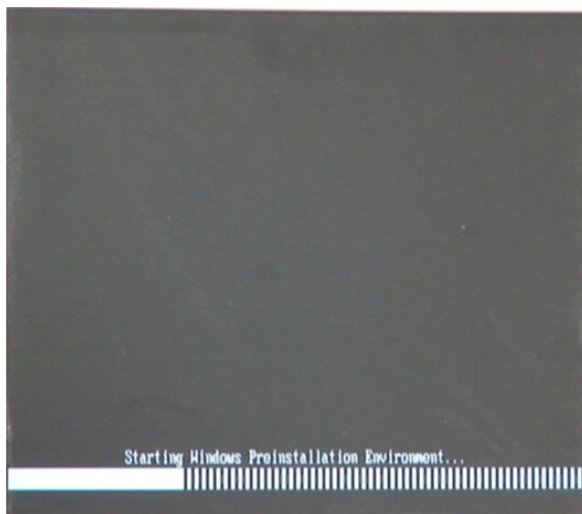

Figure A-23: Launching the Recovery Tool

Step 4: When the recovery tool setup menu appears, press <4> then <Enter>.

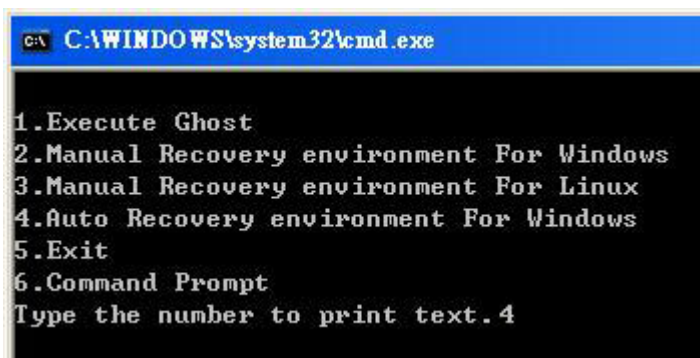

Figure A-24: Auto Recovery Environment for Windows

Step 5: The Symantec Ghost window appears and starts configuring the system to build an auto recovery partition. In this process the partition created for recovery files in **Section A.2.2** is hidden and the auto recovery tool is saved in this partition.

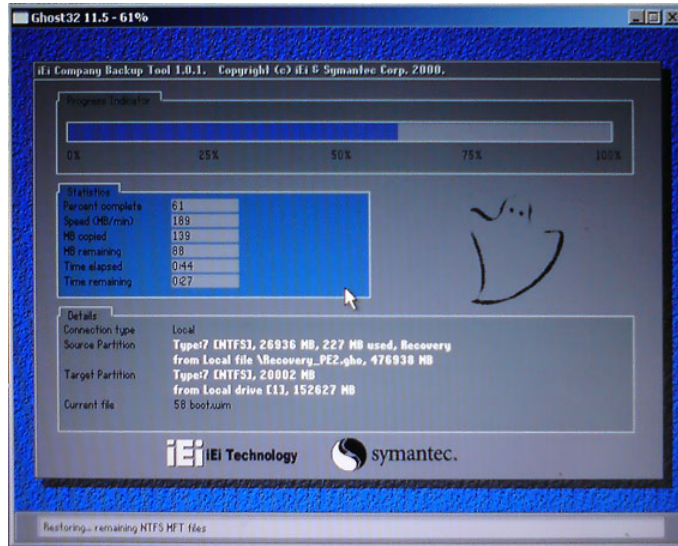

Figure A-25: Building the Auto Recovery Partition

Step 6: After completing the system configuration, the following message prompts to confirm whether to create a factory default image. Type **Y** to have the system create a factory default image automatically. Type **N** within 6 seconds to skip this process (The default option is YES). It is suggested to choose YES for this option.



Figure A-26: Factory Default Image Confirmation

TANK-101B/BW Embedded System

Step 7: The Symantec Ghost starts to create the factory default image (**Figure A-27**).

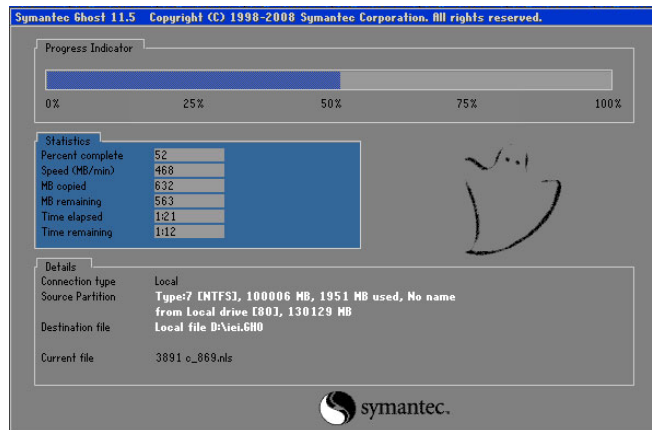

Figure A-27: Image Creation Complete

Step 8: After completing the system configuration, press any key in the following window to restart the system.

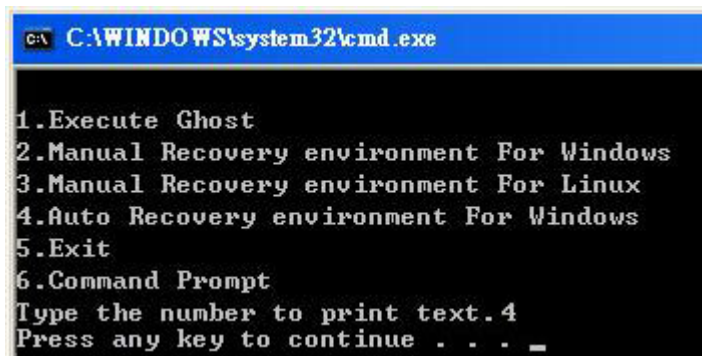

Figure A-28: Press any key to continue

Step 9: Eject the One Key Recovery CD and restart the system.

Step 10: Press the <DELETE> key as soon as the system is turned on to enter the BIOS.

Step 11: Enable the Auto Recovery Function option (**Advanced** → **iEi Feature** → **Auto Recovery Function**).

```

BIOS SETUP UTILITY
Main  Advanced  PCIPNP  Boot  Security  Chipset  Exit
-----
iEi Feature
-----
Auto Recovery Function      [Enabled]
Recover from PXE           [Disabled]

                                  ←→  Select Screen
                                  ↑↓  Select Item
                                  Enter Go to SubScreen
                                  F1   General Help
                                  F10  Save and Exit
                                  ESC  Exit

v02.61 ©Copyright 1985-2006, American Megatrends, Inc.

```

BIOS Menu 20: IEI Feature

Step 12: Save changes and restart the system. If the system encounters a Blue Screen of Death (BSoD) or a hang for around 10 minutes, it will automatically restore from the factory default image.

CAUTION:

The auto recovery function can only apply on a Microsoft Windows system running the following OS versions:

- Windows XP
- Windows Vista
- Windows 7

A.4 Setup Procedure for Linux

The initial setup procedures for a Linux system are mostly the same with the procedure for Microsoft Windows. Please follow the steps below to setup the recovery tool for Linux OS.

Step 1: Hardware and BIOS setup. Refer to **Section A.2.1**.

TANK-101B/BW Embedded System

Step 2: Install Linux operating system. Make sure to install GRUB (v0.97 or earlier) MBR type and Ext3 partition type. Leave enough space on the hard drive to create the recover partition later.



NOTE:

If the Linux OS is not installed with GRUB (v0.97 or earlier) and Ext3, the Symantec Ghost may not function properly.

While installing Linux OS, please create two partitions:

- Partition 1: /
- Partition 2: **SWAP**



NOTE:

Please reserve enough space for partition 3 for saving recovery images.

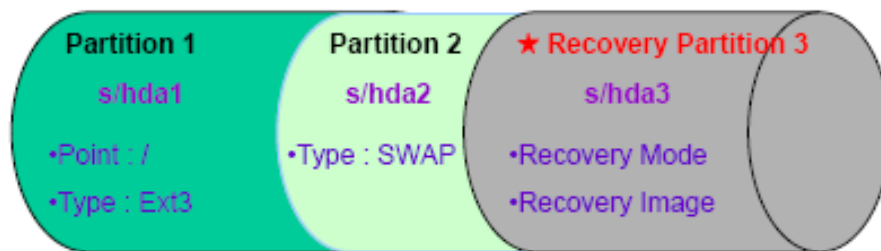

Figure A-29: Partitions for Linux

Step 3: Create a recovery partition. Insert the recovery CD into the optical disk drive. Follow **Step 1 ~ Step 3** described in **Section A.2.2**. Then type the following commands (marked in red) to create a partition for recovery images.

```
system32>diskpart
```

```
DISKPART>list vol
```

```
DISKPART>sel disk 0
```



```

DISKPART>create part pri size= ____
DISKPART>assign letter=N
DISKPART>exit
system32>format N: /fs:ntfs /q /v:Recovery /y
system32>exit
  
```

Step 4: Build-up recovery partition. Press any key to boot from the recovery CD. It will take a while to launch the recovery tool. Please be patient. When the recovery tool setup menu appears, type <3> and press <Enter> (**Figure A-30**). The Symantec Ghost window appears and starts configuring the system to build-up a recovery partition. After completing the system configuration, press any key to reboot the system. Eject the recovery CD.

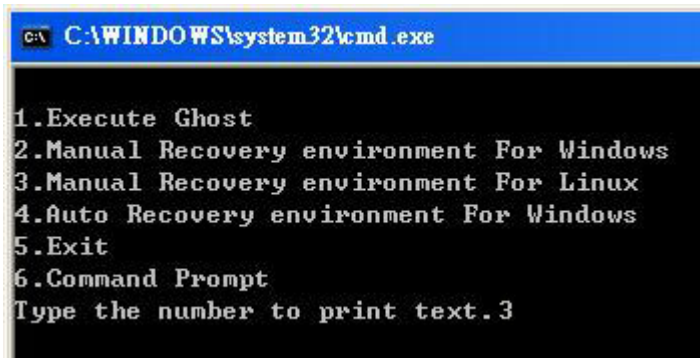

```

C:\WINDOWS\system32\cmd.exe

1.Execute Ghost
2.Manual Recovery environment For Windows
3.Manual Recovery environment For Linux
4.Auto Recovery environment For Windows
5.Exit
6.Command Prompt
Type the number to print text.3
  
```

Figure A-30: Manual Recovery Environment for Linux

Step 5: Access the recovery tool main menu by modifying the “menu.lst”. To first access the recovery tool main menu, the menu.lst must be modified. In Linux system, enter Administrator (root). When prompt appears, type:

```

cd /boot/grub
vi menu.lst
  
```

TANK-101B/BW Embedded System

```
Fedora release 9 (Sulphur)
Kernel 2.6.25-14.fc9.i686 on an i686 (tty2)

localhost login: root
Password:
[root@localhost ~]# cd /boot/grub/
[root@localhost grub]# vi menu.lst _
```

Figure A-31: Access menu.lst in Linux (Text Mode)

Step 6: Modify the menu.lst as shown below.

```
#boot=/dev/sda
default=0
timeout=10 ← Modify timeout=10
splashimage=(hd0,0)/grub/splash.xpm.gz
hiddenmenu
title Fedora (2.6.25-14.fc9.i686)
    root (hd0,0)
    kernel /vmlinuz-2.6.25-14.fc9.i686 ro root=UUID=10f1acd
ac38b5c78910 rhgb quiet
    initrd /initrd-2.6.25-14.fc9.i686.img

title Recovery Partition
root (hd0,2) ← Type command
makeactive
chainloader +1
```

- **Type command:**
title Recovery Partition
root (hd0,2)
makeactive
chainloader +1

Step 7: The recovery tool menu appears. (Figure A-32)

```
1. Factory Restore
2. Backup system
3. Restore your last backup.
4. Manual
5. Quit
Please type the number to select and then press Enter:
```

Figure A-32: Recovery Tool Menu

Step 8: Create a factory default image. Follow **Step 2 ~ Step 12** described in **Section A.2.5** to create a factory default image.

A.5 Recovery Tool Functions

After completing the initial setup procedures as described above, users can access the recovery tool by pressing <F3> while booting up the system. However, if the setup procedure in Section A.3 has been completed and the auto recovery function is enabled, the system will automatically restore from the factory default image without pressing the F3 key. The recovery tool main menu is shown below.

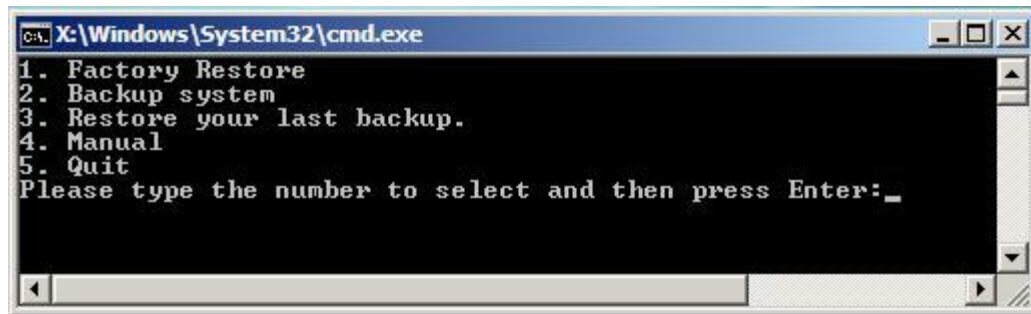

Figure A-33: Recovery Tool Main Menu

The recovery tool has several functions including:

1. **Factory Restore:** Restore the factory default image (iei.GHO) created in Section A.2.5.
2. **Backup system:** Create a system backup image (iei_user.GHO) which will be saved in the hidden partition.
3. **Restore your last backup:** Restore the last system backup image
4. **Manual:** Enter the Symantec Ghost window to configure manually.
5. **Quit:** Exit the recovery tool and restart the system.



WARNING:

Please do not turn off the system power during the process of system recovery or backup.

TANK-101B/BW Embedded System



WARNING:

All data in the system will be deleted during the system recovery. Please backup the system files before restoring the system (either Factory Restore or Restore Backup).

A.5.1 Factory Restore

To restore the factory default image, please follow the steps below.

Step 1: Type <1> and press <Enter> in the main menu.

Step 2: The Symantec Ghost window appears and starts to restore the factory default. A factory default image called **iei.GHO** is created in the hidden Recovery partition.

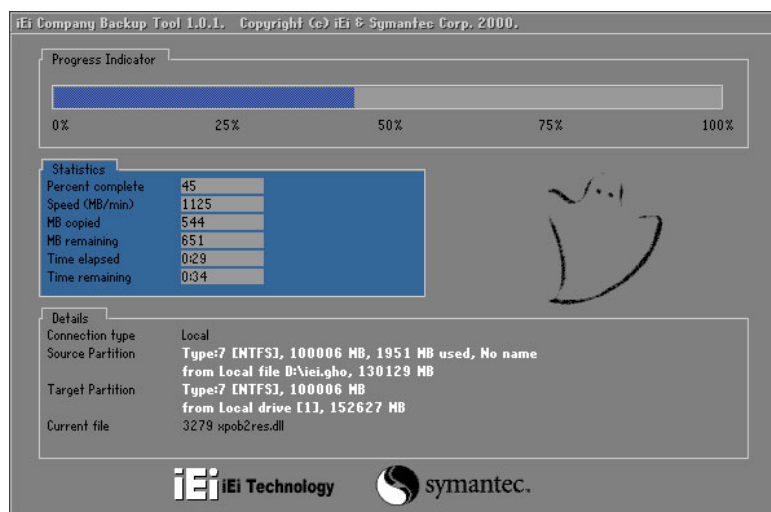

Figure A-34: Restore Factory Default

Step 3: The screen is shown as in **Figure A-35** when completed. Press any key to reboot the system.

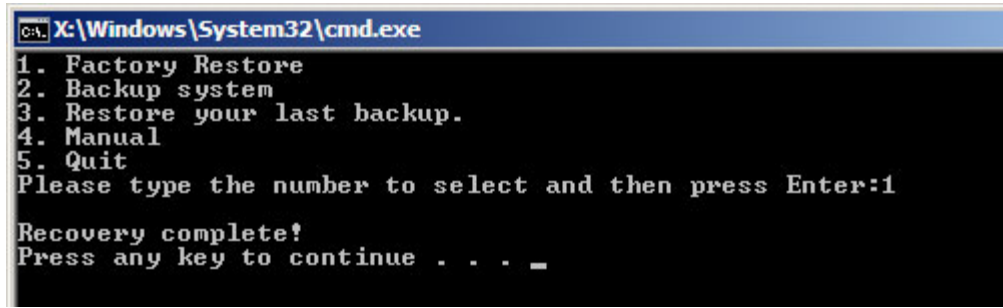

Figure A-35: Recovery Complete Window

A.5.2 Backup System

To backup the system, please follow the steps below.

Step 1: Type <2> and press <Enter> in the main menu.

Step 2: The Symantec Ghost window appears and starts to backup the system. A backup image called `iei_user.GHO` is created in the hidden Recovery partition.

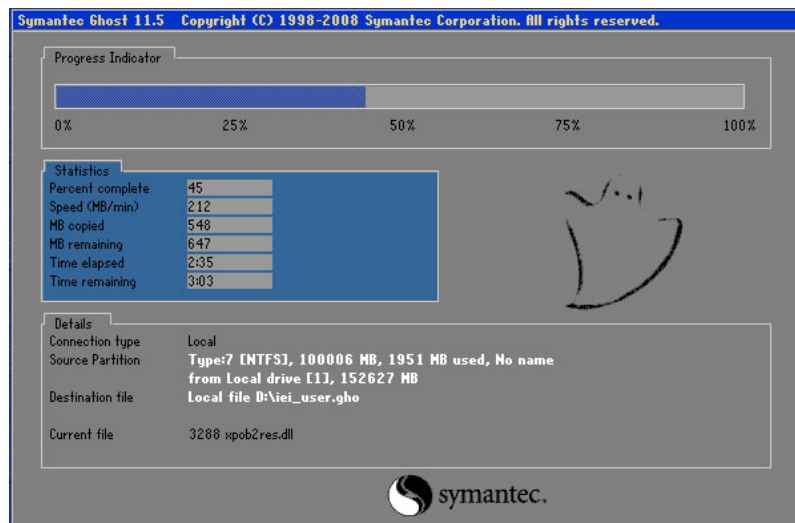

Figure A-36: Backup System

Step 3: The screen is shown as in **Figure A-37** when system backup is completed. Press any key to reboot the system.

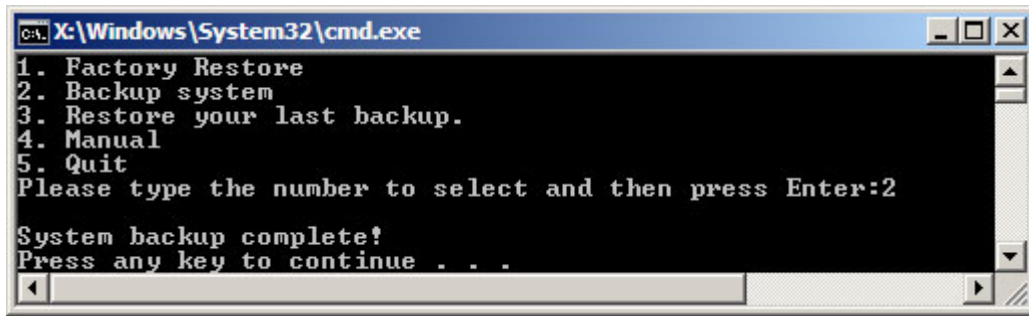

Figure A-37: System Backup Complete Window

A.5.3 Restore Your Last Backup

To restore the last system backup, please follow the steps below.

Step 1: Type <3> and press <Enter> in the main menu.

Step 2: The Symantec Ghost window appears and starts to restore the last backup image (iei_user.GHO).

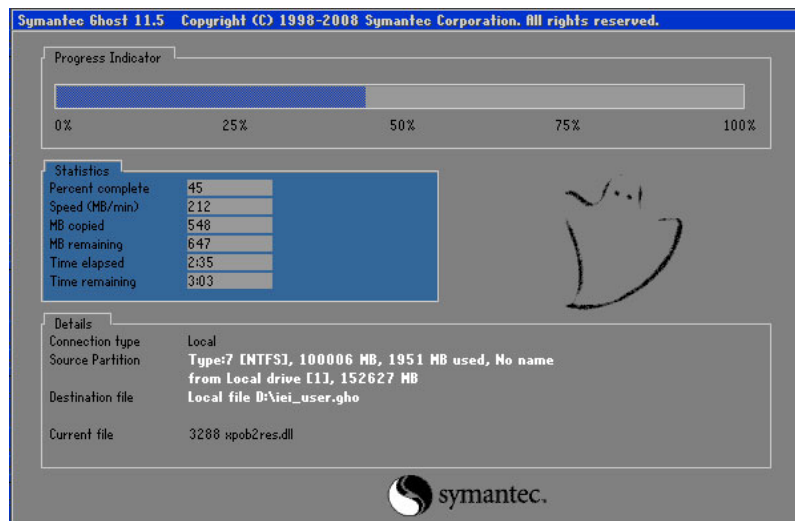

Figure A-38: Restore Backup

Step 3: The screen is shown as in **Figure A-39** when backup recovery is completed. Press any key to reboot the system.

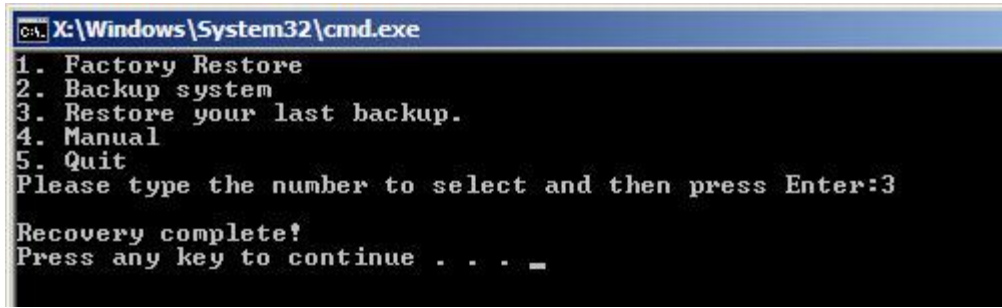

Figure A-39: Restore System Backup Complete Window

A.5.4 Manual

To restore the last system backup, please follow the steps below.

Step 1: Type <4> and press <Enter> in the main menu.

Step 2: The Symantec Ghost window appears. Use the Ghost program to backup or recover the system manually.

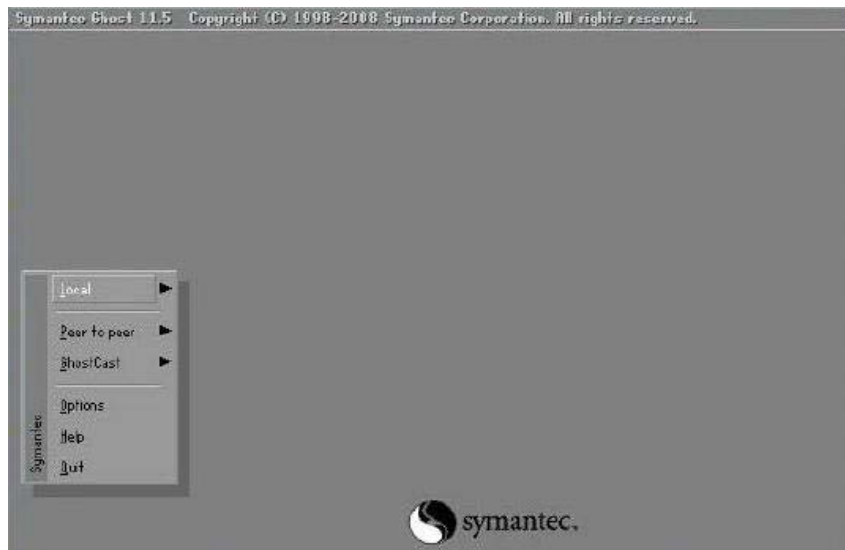
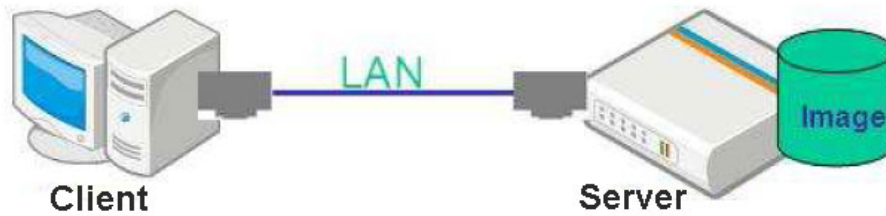

Figure A-40: Symantec Ghost Window

Step 3: When backup or recovery is completed, press any key to reboot the system.

A.6 Restore Systems from a Linux Server through LAN

The One Key Recovery allows a client system to automatically restore to a factory default image saved in a Linux system (the server) through LAN connectivity after encountering a Blue Screen of Death (BSoD) or a hang for around 10 minutes. To be able to use this function, the client system and the Linux system MUST reside in the same domain.



NOTE:

The supported client OS includes:

- Windows 2000
- Windows XP
- Windows Vista
- Windows 7
- Windows CE
- Windows XP Embedded

Prior to restoring client systems from a Linux server, a few setup procedures are required.

Step 1: Configure DHCP server settings

Step 2: Configure TFTP settings

Step 3: Configure One Key Recovery server settings

Step 4: Start DHCP, TFTP and HTTP

Step 5: Create a shared directory

Step 6: Setup a client system for auto recovery

The detailed descriptions are described in the following sections. In this document, two types of Linux OS are used as examples to explain the configuration process – CentOS 5.5 (Kernel 2.6.18) and Debian 5.0.7 (Kernel 2.6.26).

A.6.1 Configure DHCP Server Settings

Step 1: Install the DHCP

`#yum install dhcp` (CentOS, commands marked in red)

`#apt-get install dhcp3-server` (Debian, commands marked in blue)

Step 2: Confirm the operating system default settings: dhcpd.conf.

CentOS

Use the following command to show the DHCP server sample location:

`#vi /etc/dhcpd.conf`

The DHCP server sample location is shown as below:

```
# DHCP Server Configuration file.
# see /usr/share/doc/dhcp*/dhcpd.conf.sample
#
```

Use the following command to copy the DHCP server sample to etc/dhcpd.conf:

`#cp /usr/share/doc/dhcp-3.0.5/dhcpd.conf.sample /etc/dhcpd.conf`

`#vi /etc/dhcpd.conf`

```
ddns-update-style interim;
ignore client-updates;

subnet 192.168.0.0 netmask 255.255.255.0 {
# --- default gateway
    option routers                192.168.0.2;
    option subnet-mask            255.255.255.0;

    option nis-domain             "domain.org";
    option domain-name           "domain.org";
    option domain-name-servers   192.168.0.1;
    next-server 192.168.0.6;
    filename "pxelinux.0";
    option time-offset            -18000; # Eastern Standard Time
    option ntp-servers            192.168.1.1;
    option netbios-name-servers  192.168.1.1;
}
```

Debian

`#vi /etc/dhcpd.conf`

Edit “/etc/dhcpd.conf” for your environment. For example, add

`next-server PXE server IP address;`

filename "pxelinux.0";

```
ddns-update-style interim;
ignore client-updates;

subnet 192.168.0.0 netmask 255.255.255.0 {
# --- default gateway
    option routers                192.168.0.2;
    option subnet-mask            255.255.255.0;

    option nis-domain             "domain.org";
    option domain-name            "domain.org";
    option domain-name-servers    192.168.0.1;
    next-server 192.168.0.6;
    filename "pxelinux.0";
    option time-offset             -18000; # Eastern Standard Time
    option ntp-servers             192.168.1.1;
}
```

A.6.2 Configure TFTP Settings

Step 1: Install the tftp, httpd and syslinux.

`#yum install tftp-server httpd syslinux` (CentOS)

`#apt-get install tftpd-hpa xinetd syslinux` (Debian)

Step 2: Enable the TFTP server by editing the "/etc/xinetd.d/tftp" file and make it use the remap file. The "-vvv" is optional but it could definitely help on getting more information while running the remap file. For example:

CentOS

`#vi /etc/xinetd.d/tftp`

Modify:

`disable = no`

`server_args = -s /tftpboot -m /tftpboot/tftpd.remap -vvv_`

```
socket_type      = dgram
protocol         = udp
wait            = yes
user            = root
server          = /usr/sbin/in.tftpd
server_args     = -s /tftpboot -m /tftpboot/tftpd.remap -vvv
disable         = no
per_source      = 11
cps             = 100 2
flags           = IPv4
```

Debian

Replace the TFTP settings from “inetd” to “xinetd” and annotate the “inetd” by adding “#”.

`#vi /etc/inetd.conf`

Modify: `#tftp dgram udp wait root /usr/sbin.....` (as shown below)

```
#:BOOT: TFTP service is provided primarily for booting. Most sites
#      run this only on machines acting as "boot servers."
#tftp  dgram  udp    wait  root  /usr/sbin/in.tftpd /usr/sbin/in.tftpd -s
#      /var/lib/tftpboot
```

`#vi /etc/xinetd.d/tftp`

```
socket_type      = dgram
protocol        = udp
wait            = yes
user            = root
server          = /usr/sbin/in.tftpd
server_args     = -s /tftpboot -n /tftpboot/tftpd.remap -vvv
disable         = no
per_source      = 11
cps             = 100 2
flags           = IPv4
```

A.6.3 Configure One Key Recovery Server Settings

Step 1: Copy the **Utility/RECOVERYR10.TAR.BZ2** package from the One Key Recovery CD to the system (server side).



Step 2: Extract the recovery package to /.

```
#cp RecoveryR10.tar.bz2 /
#cd /
#tar -xvjf RecoveryR10.tar.bz2
```

Step 3: Copy “pxelinux.0” from “syslinux” and install to “/tftpboot”.

```
#cp /usr/lib/syslinux/pxelinux.0 /tftpboot/
```

TANK-101B/BW Embedded System

A.6.4 Start the DHCP, TFTP and HTTP

Start the DHCP, TFTP and HTTP. For example:

CentOS

```
#service xinetd restart
```

```
#service httpd restart
```

```
#service dhcpd restart
```

Debian

```
#/etc/init.d/xinetd reload
```

```
#/etc/init.d/xinetd restart
```

```
#/etc/init.d/dhcp3-server restart
```

A.6.5 Create Shared Directory

Step 1: Install the samba.

```
#yum install samba
```

Step 2: Create a shared directory for the factory default image.

```
#mkdir /share
```

```
#cd /share
```

```
#mkdir /image
```

```
#cp iei.gho /image
```



WARNING:

The file name of the factory default image must be **iei.gho**.

Step 3: Confirm the operating system default settings: smb.conf.

```
#vi /etc/samba/smb.conf
```

Modify:

[image]

```
comment = One Key Recovery
```

```
path = /share/image
```

```
browseable = yes
```

```
writable = yes
```

```
public = yes
```

```
create mask = 0644
```

```
directory mask = 0755
```

Step 4: Edit “/etc/samba/smb.conf” for your environment. For example:

```
# "security = user" is always a good idea. This will require a Unix account
# in this server for every user accessing the server. See
# /usr/share/doc/samba-doc/html/docs/Samba3-HOWTO/ServerType.html
# in the samba-doc package for details.
security = share
```

```
[image]
comment = One Key Recovery
path = /share/image
browseable = yes
writable = yes
public = yes
create mask = 0644
directory mask = 0755
```

Step 5: Modify the hostname

```
#vi /etc/hostname
```

Modify: RecoveryServer

```
RecoveryServer
```

A.6.6 Setup a Client System for Auto Recovery

Step 1: Configure the following BIOS options of the client system.

Advanced → iEi Feature → Auto Recovery Function → **Enabled**

Advanced → iEi Feature → Recover from PXE → **Enabled**

Boot → Launch PXE OpROM → **Enabled**

TANK-101B/BW Embedded System

Step 2: Continue to configure the **Boot Option Priorities** BIOS option of the client system:

Boot Option #1 → remain the default setting to boot from the original OS.

Boot Option #2 → select the boot from LAN option.

Step 3: Save changes and exit BIOS menu.

Exit → **Save Changes and Exit**

Step 4: Install the auto recovery utility into the system by double clicking the **Utility/AUTORECOVERY-SETUP.exe** in the One Key Recovery CD. This utility **MUST** be installed in the system, otherwise, the system will automatically restore from the factory default image every ten (10) minutes.



Step 5: Restart the client system from LAN. If the system encounters a Blue Screen of Death (BSoD) or a hang for around 10 minutes, it will automatically restore from the factory default image. The following screens will show when the system starts auto recovering.

```
Realtek PCIe GBE Family Controller Series v2.35 (06/14/10)
CLIENT MAC ADDR: 00 18 7D 13 E6 89  GUID: 00020003-0004-0005-0006-0007000000
DHCP . . /
```

```
My IP address seems to be C0A80009 192.168.0.9
ip=192.168.0.9:192.168.0.8:192.168.0.2:255.255.255.0
TFTP prefix:
Trying to load: pxelinux.cfg/00020003-0004-0005-0006-000700080009
Trying to load: pxelinux.cfg/01-00-10-7d-13-e6-89
Trying to load: pxelinux.cfg/C0A80009
Trying to load: pxelinux.cfg/C0A8000
Trying to load: pxelinux.cfg/C0A800
Trying to load: pxelinux.cfg/C0A80
Trying to load: pxelinux.cfg/C0A8
Trying to load: pxelinux.cfg/C0A
Trying to load: pxelinux.cfg/C0
Trying to load: pxelinux.cfg/C
Trying to load: pxelinux.cfg/default
boot:
```

Windows is loading files...

IP: 192.168.0.8, File: \Boot\WinPE.wim

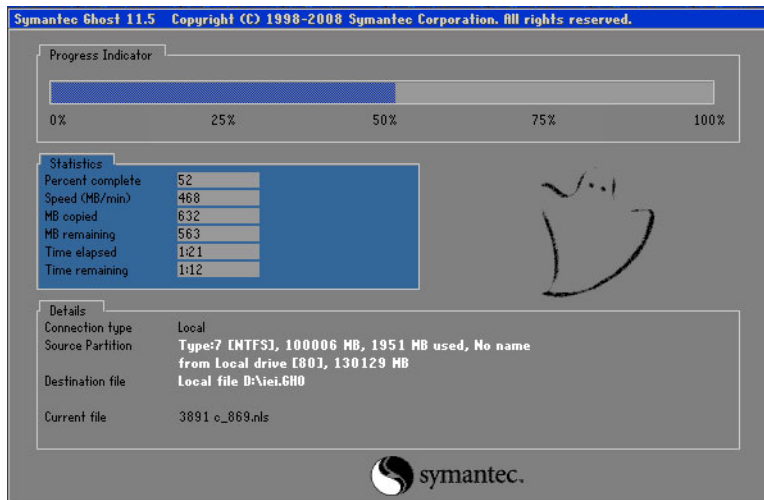

Symantec Ghost 11.5 Copyright (C) 1998-2008 Symantec Corporation. All rights reserved.

Progress Indicator

0% 25% 50% 75% 100%

Statistics

Percent complete	52
Speed (MB/min)	468
MB copied	632
MB remaining	563
Time elapsed	1:21
Time remaining	1:12

Details

Connection type	Local
Source Partition	Type:7 [NTFS], 100006 MB, 1951 MB used, No name from Local drive [80], 130129 MB
Destination file	Local file D:\iei.GHO
Current file	3891_e_869.nls

 symantec.



NOTE:

A firewall or a SELinux is not in use in the whole setup process. If there is a firewall or a SELinux protecting the system, modify the configuration information to accommodate them.

TANK-101B/BW Embedded System

A.7 Other Information

A.7.1 Using AHCI Mode or ALi M5283 / VIA VT6421A Controller

When the system uses AHCI mode or some specific SATA controllers such as ALi M5283 or VIA VT6421A, the SATA RAID/AHCI driver must be installed before using one key recovery. Please follow the steps below to install the SATA RAID/AHCI driver.

Step 1: Copy the SATA RAID/AHCI driver to a floppy disk and insert the floppy disk into a USB floppy disk drive. The SATA RAID/AHCI driver must be especially designed for the on-board SATA controller.

Step 2: Connect the USB floppy disk drive to the system.

Step 3: Insert the One Key Recovery CD into the system and boot the system from the CD.

Step 4: When launching the recovery tool, press <F6>.

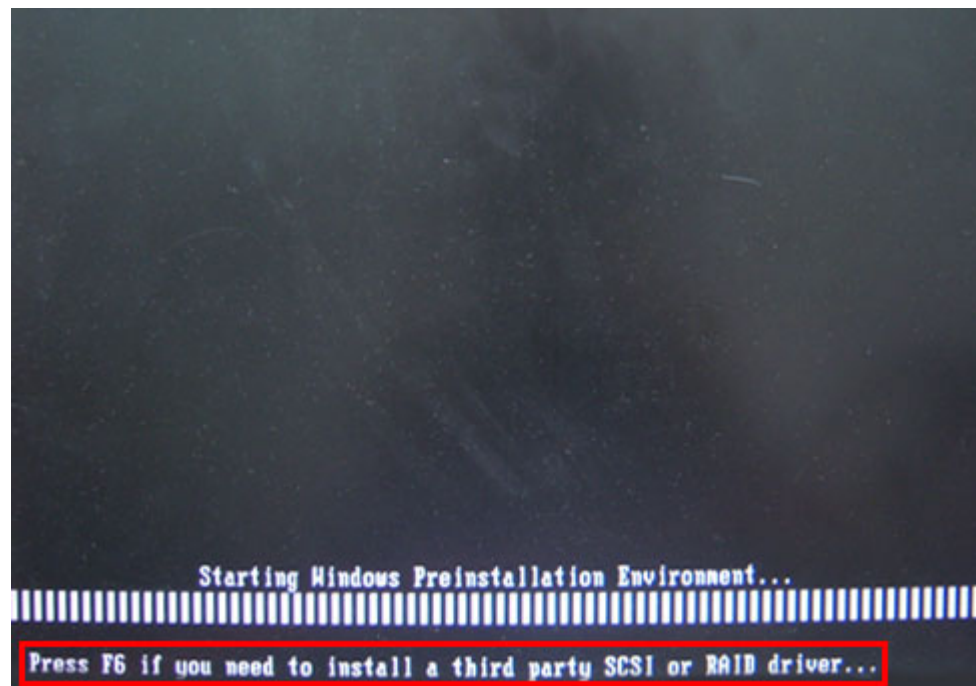

Step 5: When the following window appears, press <S> to select “Specify Additional Device”.

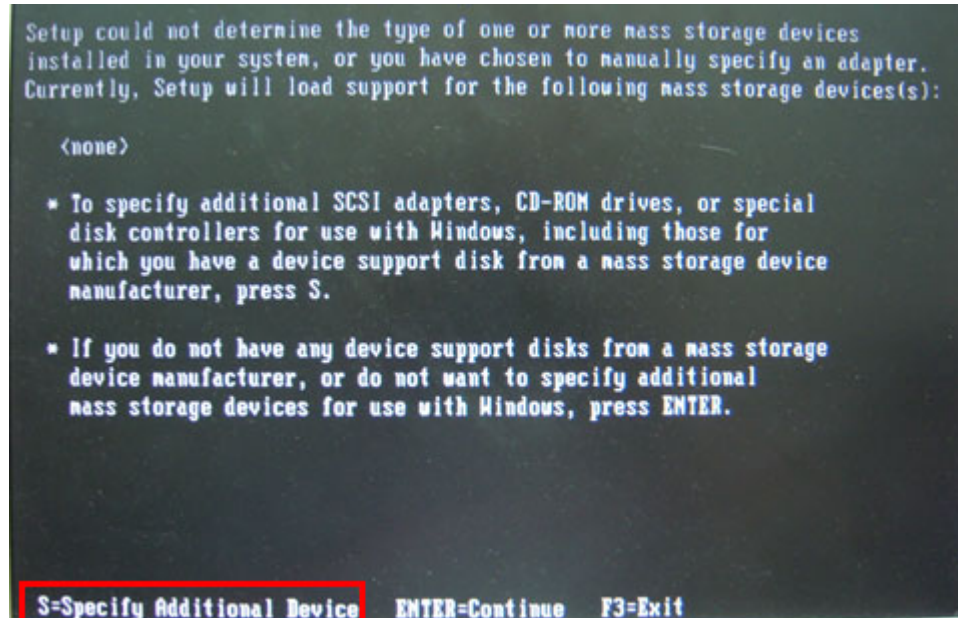

Step 6: In the following window, select a SATA controller mode used in the system. Then press <Enter>. The user can now start using the SATA HDD.

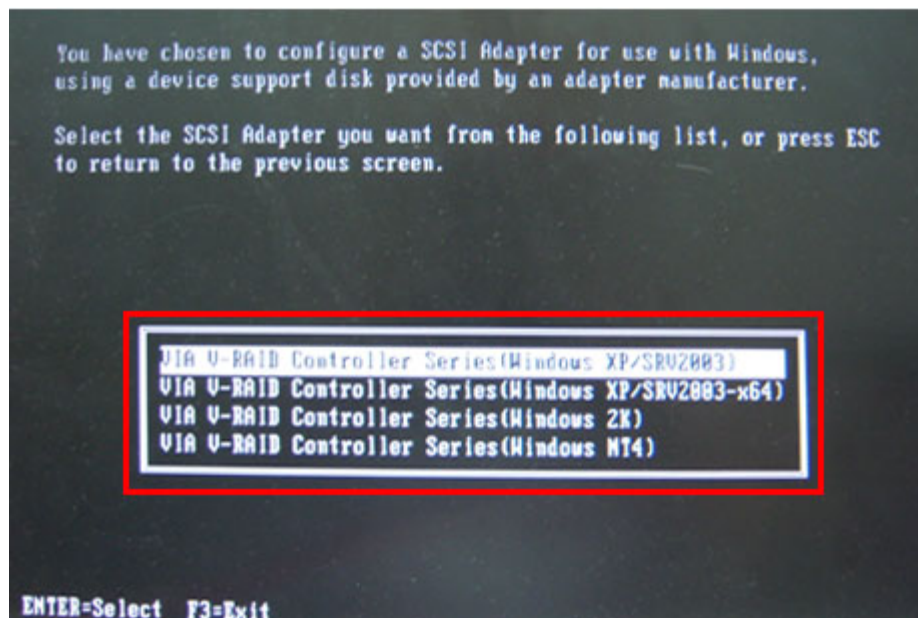

TANK-101B/BW Embedded System

Step 7: After pressing <Enter>, the system will get into the recovery tool setup menu.

Continue to follow the setup procedure from **Step 4** in **Section A.2.2 Create Partitions** to finish the whole setup process.

A.7.2 System Memory Requirement

To be able to access the recovery tool by pressing <F3> while booting up the system, please make sure to have enough system memory. The minimum memory requirement is listed below.

- **Using Award BIOS:** 128 MB system memory
- **Using AMI BIOS:** 512 MB system memory.

Appendix

B

Safety Precautions

TANK-101B/BW Embedded System

B.1 Safety Precautions



WARNING:

The precautions outlined in this appendix should be strictly followed. Failure to follow these precautions may result in permanent damage to the TANK-101B/BW.

Please follow the safety precautions outlined in the sections that follow:

B.1.1 General Safety Precautions

Please ensure the following safety precautions are adhered to at all times.

- ***Make sure the power is turned off and the power cord is disconnected*** when moving, installing or modifying the system.
- ***Do not apply voltage levels that exceed the specified voltage range.*** Doing so may cause fire and/or an electrical shock.
- ***Electric shocks can occur*** if opened while still powered on.
- ***Do not drop or insert any objects*** into the ventilation openings.
- ***If considerable amounts of dust, water, or fluids enter the system***, turn off the power supply immediately, unplug the power cord, and contact the system vendor.
- **DO NOT:**
 - Drop the system against a hard surface.
 - Strike or exert excessive force onto the LCD panel.
 - Touch any of the LCD panels with a sharp object
 - Use in a site where the ambient temperature exceeds the rated temperature

B.1.2 Anti-static Precautions



WARNING:

Failure to take ESD precautions during the installation of the TANK-101B/BW may result in permanent damage to the TANK-101B/BW and severe injury to the user.

Electrostatic discharge (ESD) can cause serious damage to electronic components, including the TANK-101B/BW. Dry climates are especially susceptible to ESD. It is therefore critical that whenever the TANK-101B/BW is opened and any of the electrical components are handled, the following anti-static precautions are strictly adhered to.

- ***Wear an anti-static wristband:*** Wearing a simple anti-static wristband can help to prevent ESD from damaging any electrical component.
- ***Self-grounding:*** Before handling any electrical component, touch any grounded conducting material. During the time the electrical component is handled, frequently touch any conducting materials that are connected to the ground.
- ***Use an anti-static pad:*** When configuring or working with an electrical component, place it on an anti-static pad. This reduces the possibility of ESD damage.
- ***Only handle the edges of the electrical component:*** When handling the electrical component, hold the electrical component by its edges.

TANK-101B/BW Embedded System

B.1.3 Product Disposal



CAUTION:

Risk of explosion if battery is replaced by an incorrect type. Only certified engineers should replace the on-board battery.

Dispose of used batteries according to instructions and local regulations.

- Outside the European Union - If you wish to dispose of used electrical and electronic products outside the European Union, please contact your local authority so as to comply with the correct disposal method.
- Within the European Union:



EU-wide legislation, as implemented in each Member State, requires that waste electrical and electronic products carrying the mark (left) must be disposed of separately from normal household waste. This includes monitors and electrical accessories, such as signal cables or power cords.

When you need to dispose of your display products, please follow the guidance of your local authority, or ask the shop where you purchased the product. The mark on electrical and electronic products only applies to the current European Union Member States.

Please follow the national guidelines for electrical and electronic product disposal.

B.2 Maintenance and Cleaning Precautions

When maintaining or cleaning the TANK-101B/BW, please follow the guidelines below.

B.2.1 Maintenance and Cleaning

Prior to cleaning any part or component of the TANK-101B/BW, please read the details below.

- The interior of the TANK-101B/BW does not require cleaning. Keep fluids away from the TANK-101B/BW interior.
- Be cautious of all small removable components when vacuuming the TANK-101B/BW.
- Turn the TANK-101B/BW off before cleaning the TANK-101B/BW.
- Never drop any objects or liquids through the openings of the TANK-101B/BW.
- Be cautious of any possible allergic reactions to solvents or chemicals used when cleaning the TANK-101B/BW.
- Avoid eating, drinking and smoking within vicinity of the TANK-101B/BW.

B.2.2 Cleaning Tools

Some components in the TANK-101B/BW may only be cleaned using a product specifically designed for the purpose. In such case, the product will be explicitly mentioned in the cleaning tips. Below is a list of items to use when cleaning the TANK-101B/BW.

- **Cloth** – Although paper towels or tissues can be used, a soft, clean piece of cloth is recommended when cleaning the TANK-101B/BW.
- **Water or rubbing alcohol** – A cloth moistened with water or rubbing alcohol can be used to clean the TANK-101B/BW.
- **Using solvents** – The use of solvents is not recommended when cleaning the TANK-101B/BW as they may damage the plastic parts.
- **Vacuum cleaner** – Using a vacuum specifically designed for computers is one of the best methods of cleaning the TANK-101B/BW. Dust and dirt can restrict the airflow in the TANK-101B/BW and cause its circuitry to corrode.
- **Cotton swabs** - Cotton swabs moistened with rubbing alcohol or water are excellent tools for wiping hard to reach areas.
- **Foam swabs** - Whenever possible, it is best to use lint free swabs such as foam swabs for cleaning.

Appendix

C

Hazardous Materials Disclosure

C.1 Hazardous Materials Disclosure Table for IPB Products Certified as RoHS Compliant Under 2002/95/EC Without Mercury

The details provided in this appendix are to ensure that the product is compliant with the Peoples Republic of China (China) RoHS standards. The table below acknowledges the presences of small quantities of certain materials in the product, and is applicable to China RoHS only.

A label will be placed on each product to indicate the estimated “Environmentally Friendly Use Period” (EFUP). This is an estimate of the number of years that these substances would “not leak out or undergo abrupt change.” This product may contain replaceable sub-assemblies/components which have a shorter EFUP such as batteries and lamps. These components will be separately marked.

Please refer to the table on the next page.

TANK-101B/BW Embedded System

Part Name	Toxic or Hazardous Substances and Elements					
	Lead (Pb)	Mercury (Hg)	Cadmium (Cd)	Hexavalent Chromium (CR(VI))	Polybrominated Biphenyls (PBB)	Polybrominated Diphenyl Ethers (PBDE)
Housing	X	O	O	O	O	X
Display	X	O	O	O	O	X
Printed Circuit Board	X	O	O	O	O	X
Metal Fasteners	X	O	O	O	O	O
Cable Assembly	X	O	O	O	O	X
Fan Assembly	X	O	O	O	O	X
Power Supply Assemblies	X	O	O	O	O	X
Battery	O	O	O	O	O	O

O: This toxic or hazardous substance is contained in all of the homogeneous materials for the part is below the limit requirement in SJ/T11363-2006

X: This toxic or hazardous substance is contained in at least one of the homogeneous materials for this part is above the limit requirement in SJ/T11363-2006

此附件旨在确保本产品符合中国 RoHS 标准。以下表格标示此产品中某有毒物质的含量符合中国 RoHS 标准规定的限量要求。

本产品上会附有“环境友好使用期限”的标签，此期限是估算这些物质“不会有泄漏或突变”的年限。本产品可能包含有较短的环境友好使用期限的可替换元件，像是电池或灯管，这些元件将会单独标示出来。

部件名称	有毒有害物质或元素					
	铅 (Pb)	汞 (Hg)	镉 (Cd)	六价铬 (CR(VI))	多溴联苯 (PBB)	多溴二苯 醚 (PBDE)
壳体	X	O	O	O	O	X
显示	X	O	O	O	O	X
印刷电路板	X	O	O	O	O	X
金属螺帽	X	O	O	O	O	O
电缆组装	X	O	O	O	O	X
风扇组装	X	O	O	O	O	X
电力供应组装	X	O	O	O	O	X
电池	O	O	O	O	O	O

O: 表示该有毒有害物质在该部件所有物质材料中的含量均在 SJ/T11363-2006 标准规定的限量要求以下。
X: 表示该有毒有害物质至少在该部件的某一均质材料中的含量超出 SJ/T11363-2006 标准规定的限量要求。