



IEI Technology Corp .



MODEL:
ECW-281B/B2-D525

IEI Intel® Atom™ Fanless Embedded System

RoHS Compliant, Dual GbE LAN, COM Ports, USB 2.0

User Manual

Rev. 1.03 19 October, 2012



Revision

Date	Version	Changes
19 October, 2012	1.03	Added bottom cover screw torque warning
24 October, 2011	1.02	Modified COM port locations in Section 2.3.2 Updated Chapter 5: BIOS
17 May, 2011	1.01	Added Section A.1.3 Product Disposal
7 December, 2010	1.00	Initial release

Copyright

COPYRIGHT NOTICE

The information in this document is subject to change without prior notice in order to improve reliability, design and function and does not represent a commitment on the part of the manufacturer.

In no event will the manufacturer be liable for direct, indirect, special, incidental, or consequential damages arising out of the use or inability to use the product or documentation, even if advised of the possibility of such damages.

This document contains proprietary information protected by copyright. All rights are reserved. No part of this manual may be reproduced by any mechanical, electronic, or other means in any form without prior written permission of the manufacturer.

TRADEMARKS

All registered trademarks and product names mentioned herein are used for identification purposes only and may be trademarks and/or registered trademarks of their respective owners.

WARNING

This device complies with Part 15 of the FCC Rules. Operation is subject to the following two conditions:

(1) this device may not cause harmful interference, and(2) this device must accept any interference received, including interference that may cause undesired operation.

NOTE: This equipment has been tested and found to comply with the limits for a Class B digital device, pursuant to part 15 of the FCC Rules. These limits are designed to provide reasonable protection against harmful interference in a residential installation. This equipment generates, uses and can radiate radio frequency energy and, if not installed and used in accordance with the instructions, may cause harmful interference to radio communications.

However, there is no guarantee that interference will not occur in a particular installation. If this equipment does cause harmful interference to radio or television reception, which can be determined by turning the equipment off and on, the user is encouraged to try to correct the interference by one or more of the following measures:

- Reorient or relocate the receiving antenna.
- Increase the separation between the equipment and receiver.
- Connect the equipment into an outlet on a circuit different from that to which the receiver is connected.
- Consult the dealer or an experienced radio/ TV technician for help.

You are cautioned that any change or modifications to the equipment not expressly approve by the party responsible for compliance could void your authority to operate such equipment.

IMPORTANT NOTE:

FCC Radiation Exposure Statement:

This equipment complies with FCC radiation exposure limits set forth for an uncontrolled environment. This equipment should be installed and operated with minimum distance 20cm between the radiator & your body.

Table of Contents

1 INTRODUCTION.....	1
1.1 OVERVIEW.....	2
1.1.1 Benefits.....	2
1.1.2 Features	2
1.2 MODEL VARIATIONS	3
1.3 TECHNICAL SPECIFICATIONS	4
1.4 POWER MODULE SPECIFICATIONS (OPTIONAL)	6
1.5 POWER ADAPTER (OPTIONAL)	7
2 MECHANICAL DESCRIPTION.....	8
2.1 MECHANICAL OVERVIEW	9
2.2 PHYSICAL DIMENSIONS	9
2.3 EXTERNAL OVERVIEW.....	10
2.3.1 Front Panel	10
2.3.2 Rear Panel	10
2.3.2.1 ECW-281B-D525 Rear Panel	10
2.3.2.2 ECW-281B2-D525 Rear Panel	11
2.3.3 Bottom Surface.....	12
2.4 INTERNAL OVERVIEW.....	13
3 SYSTEM COMPONENTS	14
3.1 EMBEDDED SYSTEM MOTHERBOARD.....	15
3.1.1 WAFER-PV-D5252 Motherboard Overview	15
3.1.2 CPU Support.....	16
3.2 PERIPHERAL INTERFACE CONNECTORS.....	16
3.2.1 Peripheral Interface Connectors	16
3.3 INTERNAL PERIPHERAL CONNECTORS	17
3.3.1 ATX Power Connector	17
3.3.2 Audio Connector (10-pin).....	18
3.3.3 CompactFlash® Socket.....	19
3.3.4 LED Connector	20

3.3.5	PCIe Mini Card Slot	21
3.3.6	Power Button Connector.....	23
3.3.7	Reset Button Connector	23
3.3.8	SATA Drive Connectors	24
3.3.9	Serial Port Connector (COM3, COM4, COM5 and COM6).....	25
3.3.10	Serial Port Connector (COM 2)(RS-232, RS-422 or RS-485).....	26
3.3.11	USB Connectors (Internal).....	27
4	INSTALLATION	29
4.1	ANTI-STATIC PRECAUTIONS	30
4.2	INSTALLATION PROCEDURE	30
4.2.1	Installation Procedure Overview	30
4.2.2	Unpacking	31
4.2.3	Bottom Surface Removal.....	32
4.2.4	Configure the Jumper Settings.....	33
4.2.4.1	Jumpers	34
4.2.4.2	CF Card Setup.....	35
4.2.4.3	Clear CMOS Jumper.....	35
4.2.4.4	COM 6 Function Select Jumper (ECW-281B-D525 Series Only)	37
4.2.4.5	COM 1 Pin 9 Setting Jumper	38
4.2.5	Hard Drive Installation.....	39
4.2.6	Mounting the System with Mounting Brackets.....	42
4.2.7	Mounting the System with Wall Mount Kit.....	42
4.2.8	DIN Mounting	44
4.2.9	Wireless Antenna Installation (Wireless Models Only).....	46
4.2.10	Cable Connections	47
4.3	POWER-ON PROCEDURE.....	47
4.3.1	Installation Checklist	47
4.3.2	Terminal Block Pinouts	48
4.3.3	Power-on Procedure	48
5	BIOS.....	50
5.1	INTRODUCTION.....	51
5.1.1	Starting Setup.....	51
5.1.2	Using Setup	51

ECW-281B/B2-D525 Embedded System

5.1.3	Getting Help.....	52
5.1.4	Unable to Reboot After Configuration Changes.....	52
5.1.5	BIOS Menu Bar.....	52
5.2	MAIN.....	53
5.3	ADVANCED.....	54
5.3.1	ACPI Configuration.....	54
5.3.2	CPU Configuration.....	56
5.3.3	IDE Configuration.....	57
5.3.4	USB Configuration.....	58
5.3.5	Super IO Configuration.....	59
5.3.5.1	Serial Port n Configuration.....	60
5.3.6	H/W Monitor.....	65
5.3.7	Serial Port Console Redirection.....	66
5.3.8	IEI Feature.....	68
5.4	CHIPSET.....	69
5.4.1	Host Bridge.....	70
5.4.1.1	OnChip VGA Configuration.....	71
5.4.2	South Bridge.....	72
5.4.3	Intel IGD SWSCI OpRegion.....	73
5.5	BOOT.....	75
5.6	SECURITY.....	77
5.7	EXIT.....	77
6	TROUBLESHOOTING AND MAINTENANCE.....	79
6.1	ECW-281B/B2-D525 SYSTEM MAINTENANCE OVERVIEW.....	80
6.2	SYSTEM TROUBLESHOOTING.....	80
6.2.1	The System Doesn't Turn On.....	80
6.2.2	The System Doesn't Boot Up.....	81
6.2.3	More Troubleshooting.....	82
6.3	COMPONENT REPLACEMENT PROCEDURE.....	82
6.3.1	SO-DIMM Replacement.....	83
A	SAFETY PRECAUTIONS.....	85
A.1	SAFETY PRECAUTIONS.....	86
A.1.1	General Safety Precautions.....	86

A.1.2 Anti-static Precautions	87
A.1.3 Product Disposal	88
A.2 MAINTENANCE AND CLEANING PRECAUTIONS	88
A.2.1 Maintenance and Cleaning.....	88
A.2.2 Cleaning Tools.....	89
B ONE KEY RECOVERY	90
B.1 ONE KEY RECOVERY INTRODUCTION	92
B.1.1 System Requirement.....	93
B.1.2 Supported Operating System	94
B.2 SETUP PROCEDURE FOR WINDOWS	95
B.2.1 Hardware and BIOS Setup	95
B.2.2 Create Partitions	96
B.2.3 Install Operating System, Drivers and Applications.....	99
B.2.4 Build-up Recovery Partition.....	100
B.2.5 Create Factory Default Image.....	102
B.3 SETUP PROCEDURE FOR LINUX	107
B.4 RECOVERY TOOL FUNCTIONS	110
B.4.1 Factory Restore	112
B.4.2 Backup System.....	113
B.4.3 Restore Your Last Backup.....	114
B.4.4 Manual.....	115
B.5 OTHER INFORMATION	116
B.5.1 Using AHCI Mode or ALi M5283 / VIA VT6421A Controller.....	116
B.5.2 System Memory Requirement	118
C BIOS MENU OPTIONS.....	119
C.1 BIOS CONFIGURATION OPTIONS	120
D WATCHDOG TIMER	122

List of Figures

Figure 1-1: ECW-281B/B2-D525 Series Embedded System	2
Figure 1-2: Power Adapter	7
Figure 2-1: ECW-281B/B2-D525 Dimensions (mm)	9
Figure 2-2: ECW-281B/B2-D525 Front Panel.....	10
Figure 2-3: ECW-281B-D525 Rear Panel.....	11
Figure 2-4: ECW-281B2-D525 Rear Panel	12
Figure 2-5: Bottom Surface	13
Figure 2-6: Internal Overview	13
Figure 3-1: WAFER-PV-D5252 Jumper and Connector Locations	15
Figure 3-2: ATX Power Connector Location	17
Figure 3-3: Audio Connector Pinouts (10-pin).....	18
Figure 3-4: CF Card Socket Location	19
Figure 3-5: LED Connector Locations.....	21
Figure 3-6: PCIe Mini Card Slot Location	22
Figure 3-7: Power Button Connector Location.....	23
Figure 3-8: Reset Button Connector Locations.....	24
Figure 3-9: SATA Drive Connector Locations	24
Figure 3-10: COM3 to COM6 Connector Pinout Locations.....	25
Figure 3-11: RS-232/422/485 Serial Port Connector Location.....	27
Figure 3-12: USB Connector Pinout Locations	28
Figure 4-1: Bottom Surface Retention Screws	33
Figure 4-2: Jumpers	34
Figure 4-3: CF Card Setup Jumper Location	35
Figure 4-4: Clear CMOS Jumper	36
Figure 4-5: COM 2 Function Select Jumper Location.....	37
Figure 4-6: COM 1 Pin 9 Setting Jumper Location.....	38
Figure 4-7: Hard Drive Bracket.....	39
Figure 4-8:HDD Bracket Retention Screws.....	39
Figure 4-9: HDD Retention Screws	40
Figure 4-10: HDD Thermal Pad.....	41
Figure 4-11: Mounting Bracket Retention Screws	42



Figure 4-12: Wall-mounting Bracket43

Figure 4-13: Mount the Embedded System.....44

Figure 4-14: DIN Rail Mounting Bracket.....45

Figure 4-15: Screw Locations.....45

Figure 4-16: Mounting the DIN RAIL.....46

Figure 4-17: Secure the Assembly to the DIN Rail.....46

Figure 4-18: Wireless Antenna Installation47

Figure 4-19: Terminal Block Pinouts48

Figure 4-20: Power Button.....49

Figure 6-1: SO-DIMM Installation83

Figure B-1: IEI One Key Recovery Tool Menu92

Figure B-2: Launching the Recovery Tool96

Figure B-3: Recovery Tool Setup Menu97

Figure B-4: Command Mode.....97

Figure B-5: Partition Creation Commands.....98

Figure B-6: Launching the Recovery Tool 100

Figure B-7: System Configuration for Windows 100

Figure B-8: Build-up Recovery Partition 101

Figure B-9: Press any key to continue 101

Figure B-10: Press F3 to Boot into Recovery Mode..... 102

Figure B-11: Recovery Tool Menu 102

Figure B-12: About Symantec Ghost Window..... 103

Figure B-13: Symantec Ghost Path 103

Figure B-14: Select a Local Source Drive 104

Figure B-15: Select a Source Partition from Basic Drive 104

Figure B-16: File Name to Copy Image to 105

Figure B-17: Compress Image..... 105

Figure B-18: Image Creation Confirmation 106

Figure B-19: Image Creation Process..... 106

Figure B-20: Image Creation Complete 106

Figure B-21: Press Any Key to Continue 107

Figure B-22: Partitions for Linux..... 108

Figure B-23: System Configuration for Linux..... 109

Figure B-24: Access menu.lst in Linux (Text Mode)..... 109

Figure B-25: Recovery Tool Menu 110

ECW-281B/B2-D525 Embedded System

Figure B-26: Recovery Tool Main Menu	111
Figure B-27: Restore Factory Default	112
Figure B-28: Recovery Complete Window	112
Figure B-29: Backup System	113
Figure B-30: System Backup Complete Window	113
Figure B-31: Restore Backup	114
Figure B-32: Restore System Backup Complete Window	114
Figure B-33: Symantec Ghost Window	115

List of Tables

Table 1-1: Model Variations	3
Table 1-2: Technical Specifications.....	5
Table 1-3: DC-to-DC Power Module Specifications.....	6
Table 1-4: Power Adapter Specifications	7
Table 3-1: Peripheral Interface Connectors	17
Table 3-2: ATX Power Connector Pinouts	18
Table 3-3: Audio Connector Pinouts (10-pin)	18
Table 3-4: CF Card Socket Pinouts.....	20
Table 3-5: LED Connector Pinouts	21
Table 3-6: PCIe Mini Card Slot Pinouts	23
Table 3-7: Power Button Connector Pinouts	23
Table 3-8: Reset Button Connector Pinouts	24
Table 3-9: SATA Drive Connector Pinouts.....	25
Table 3-10: COM3 to COM6 Connector Pinouts	26
Table 3-11: RS-232/RS-485 Serial Port Connector Pinouts.....	27
Table 3-12: USB Port Connector Pinouts.....	28
Table 4-1: Package List Contents	32
Table 4-2: Jumpers	34
Table 4-3: CF Card Setup Jumper Settings	35
Table 4-4: Clear CMOS Jumper Settings.....	36
Table 4-5: COM 6 Function Select Jumper Settings	37
Table 4-6: COM 1 Pin 9 Setting Jumper Settings	38
Table 5-1: BIOS Navigation Keys	52

List of BIOS Menus

BIOS Menu 1: Main	53
BIOS Menu 2: Advanced	54
BIOS Menu 3: ACPI Configuration	55
BIOS Menu 4: CPU Configuration	56
BIOS Menu 5: IDE Configuration	57
BIOS Menu 6: USB Configuration	58
BIOS Menu 7: Super IO Configuration.....	59
BIOS Menu 8: Serial Port n Configuration Menu.....	60
BIOS Menu 9: Hardware Health Configuration	65
BIOS Menu 10: Serial Port Console Redirection	67
BIOS Menu 11: IEI Feature	68
BIOS Menu 12: Chipset	69
BIOS Menu 13:Host Bridge Configuration	70
BIOS Menu 14: OnChip VGA Configuration.....	71
BIOS Menu 15:Southbridge Chipset Configuration	72
BIOS Menu 16: Intel IGD SWSCI OpRegion	74
BIOS Menu 17: Boot	75
BIOS Menu 18: Security	77
BIOS Menu 19:Exit.....	78

Chapter

1

Introduction

1.1 Overview



Figure 1-1: ECW-281B/B2-D525 Series Embedded System

There are four WAFER-PV-D5252 Intel® Atom™ based embedded solutions in the ECW-281B/B2-D525 series. All fanless motherboards have been optimized for multimedia applications that require minimum installation space. The WAFER-PV-D5252 motherboard supports a full range of functions for an AT/ATX-compatible industrial computer. ECW-281B/B2-D525 embedded subsystems are all capable of supporting one 2.5" SATA hard disk drive. The W models also have a built-in 802.11 b/g/n wireless module.

1.1.1 Benefits

The ECW-281B/B2-D525 embedded system has the following benefits:

- Easy installation saves installation time
- Complete integration saves solution development time and cost
- Secure storage with one SATA hard drive supported
- Compact size saves space
- Powerful preinstalled Intel® Atom™ D525 CPU and motherboard ensures rigorous processing needs can be met

1.1.2 Features

The ECW-281B/B2-D525 has the following features

- RoHS compliant design
- Fanless system
- 1.8 GHz Intel® Atom™ D525 CPU supported

ECW-281B/B2-D525 Embedded System

- Dual GbE LAN for high speed network applications
- One SATA hard drive supported
- Wall mount and DIN mount supported.

1.2 Model Variations

There are six models in the ECW-281B/B2-D525 embedded system series. The six models are all preinstalled with an Intel® Atom™ D525 processor and 1 GB DDR3 memory. The model variations are listed in **Table 1-1** below.

ECW-281B Series	Power	Wireless	VGA	COM Ports
ECW-281B-R10/D525/1GB	12V DC input (60 W adaptor)	No	1 x VGA	5 x RS-232 1 x RS-232 or optional RS-422/485
ECW-281BW-R10/D525/1GB	12V DC input (60 W adaptor)	Yes		
ECW-281BWD-R10/D525/1GB	9V~36V DC input	No		
ECW-281BWDW-R10/D525/1GB	9V~36V DC input	Yes		
ECW-281B2 Series	Power	Wireless	VGA	COM Ports
ECW-281B2-R10/D525/1GB	12V DC input (60 W adaptor)	No	2 x VGA	5 x RS-232
ECW-281B2W-R10/D525/1GB	12V DC input (60 W adaptor)	Yes		
ECW-281B2WD-R10/D525/1GB	9V~36V DC input	No		
ECW-281B2WDW-R10/D525/1GB	9V~36V DC input	Yes		

Table 1-1: Model Variations

1.3 Technical Specifications

The specifications for the Intel based embedded systems are listed below.

	ECW-281B-D525	ECW-281B2-D525
CPU	Preinstalled 1.8 GHz Intel® Atom™ Processor D525 with 1 MB L2 cache	
System Chipset	Intel® ICH8M	
System Memory	Preinstalled 1.0 GB DDR3 SDRAM SO-DIMM (system max. 2 GB)	
Ethernet	Dual Realtek RTL8111E GbE controllers Built-in 802.11 b/g/n wireless module for the wireless models	
Display	One VGA port	Two VGA port <ul style="list-style-type: none"> ▪ VGA1: 2048 x 1536 (max.) ▪ VGA2: 1024 x 768 (max.)
Serial Port	Five RS-232 One RS-232 or RS-422/485 (optional)	Five RS-232
USB	Four USB 2.0 ports	
Audio	One audio out	
Storage	One 2.5" SATA hard drive supported One internal CF card slot	
Chassis Construction	Aluminum Alloy	
Power Supply	9 V – 36 V DC (WD series models): Internal DC-to-DC power converter 12 V DC models: External power adapter, 90V AC ~ 264V AC @ 47Hz ~ 63Hz, 60 W	
Operating Shock	Half-sine wave shock 3G; 11ms; 3 shocks per axis	
Operating Vibration	MIL-STD-810F 514.5C-1 (HDD) MIL-STD-810F 514.5C-2 (CF)	

ECW-281B/B2-D525 Embedded System

Operating Temperature	-20°C ~ 65°C with SATA SSD, air flow* -10°C ~ 50°C with SATA HDD in wireless model, air flow* *Ambient air speed per IEC-68-2-2 standard
Color	Black
Mounting	DIN mount VESA MIS-D 75 wall mount
Weight (Net/Gross)	2.1 kg/3.9 kg
Dimensions (D x W x H)	132 mm x 229 mm x 64 mm
EMC	FCC Class A, CE

Table 1-2: Technical Specifications

1.4 Power Module Specifications (Optional)

A DC-to-DC power module is preinstalled in the WD series model to provide 9 V~36 V power input. The specifications for the IDD-936260A are shown in **Table 1-3**.

Model Name:	IDD-936260A
Input	9 V DC~36 V DC
Output:	
12V	3 A (Max.)
5V	10 A (Max.)
5VSB	0.5 A (Max.)
Max. Total Output:	60 W
Performance Characteristics:	
Noise & Ripple:	< 240 mV
Line Regulation:	< 20 mV
Load Regulation	<60 mV
Efficiency:	Up to 90%
Dimensions:	40 mm x 100 mm
Weight:	58 g
Operating Temperature:	-40°C~85°C

Table 1-3: DC-to-DC Power Module Specifications

ECW-281B/B2-D525 Embedded System

1.5 Power Adapter (Optional)

The ECW-281B/B2-D525 series models that feature 12 V DC input are shipped with a 60W power adapter.



Figure 1-2: Power Adapter

The specifications for the adapter are listed in **Table 1-4**:

Input Voltage	90 V ~ 264 V AC
Input Frequency	47 Hz ~ 63 Hz
Output Voltage	12 V
Output Current	5 A
Efficiency	87%
Operating Temperature	0 °C ~ 40 °C
Storage Temperature	-20 °C ~ 65 °C

Table 1-4: Power Adapter Specifications



Chapter

2

Mechanical Description

ECW-281B/B2-D525 Embedded System

2.1 Mechanical Overview

The ECW-281B/B2-D525 RoHS compliant, Intel® Atom™ fanless embedded system features industrial grade components that offer longer operating life, high shock/vibration resistance and endurance over a wide temperature range. The ECW-281B/B2-D525 combines these features in an aluminum enclosure. Featuring two LAN, four USB, six serial communication ports, as well as audio, and VGA, the ECW-281B/B2-D525 offers system integrators and developers the best selection of robust and high performance computing system platforms. An internal bracket supports one 2.5" SATA hard drives.

2.2 Physical Dimensions

The dimensions of the ECW-281B/B2-D525 are listed below and shown in **Figure 2-1**.

- **Height:** 64.00 mm
- **Width:** 229.00 mm
- **Length:** 132.00 mm

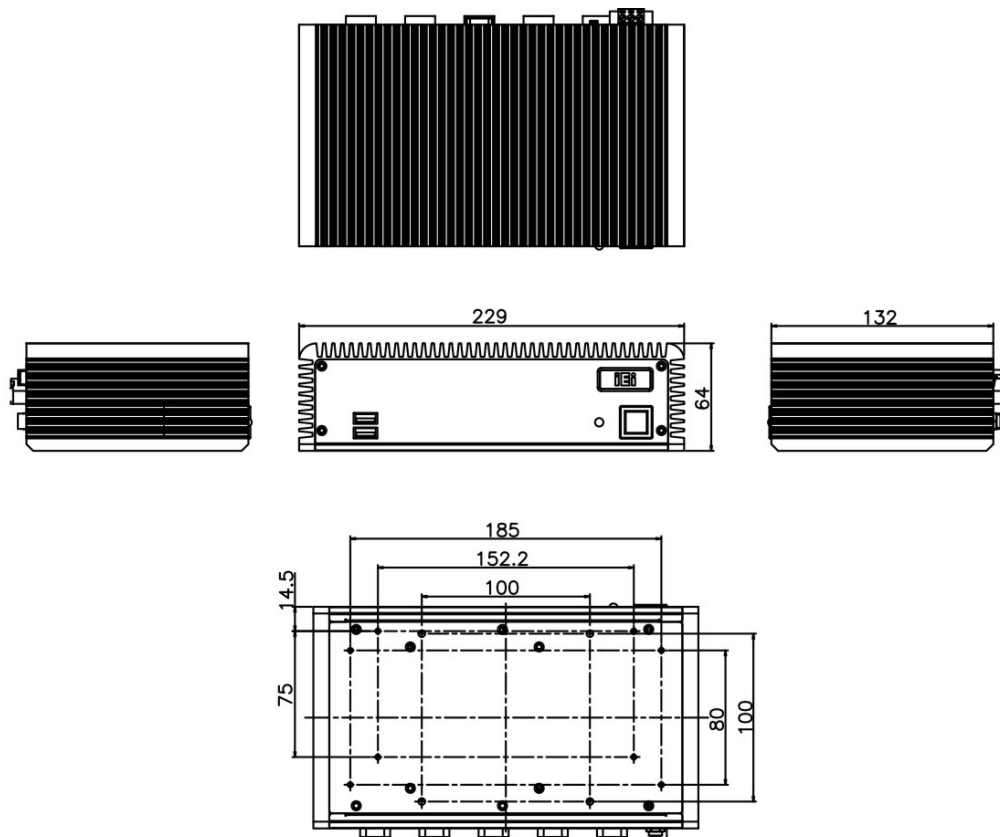

Figure 2-1: ECW-281B/B2-D525 Dimensions (mm)

2.3 External Overview

2.3.1 Front Panel

The ECW-281B/B2-D525 front panel contains:

- 2 x USB port connectors
- 1 x HDD LED indicator
- 1 x Power button

An overview of the front panel is shown in **Figure 2-2** below.



Figure 2-2: ECW-281B/B2-D525 Front Panel

2.3.2 Rear Panel

2.3.2.1 ECW-281B-D525 Rear Panel

The rear panel of the ECW-281B-D525 provides access to the following external I/O connectors.

- 2 x USB port connectors
- 2 x RJ-45 Ethernet connector
- 1 x VGA connector
- 1 x RS-232/422/485 serial port (Default: RS-232)
- 5 x RS-232 serial ports
- 1 x Speaker out
- 1 x 3-pin power terminal block
- 1 x 12V DC power jack

ECW-281B/B2-D525 Embedded System

- 1 x Wireless antenna connector (for wireless models only)

An overview of the rear panel is shown in **Figure 2-3**.

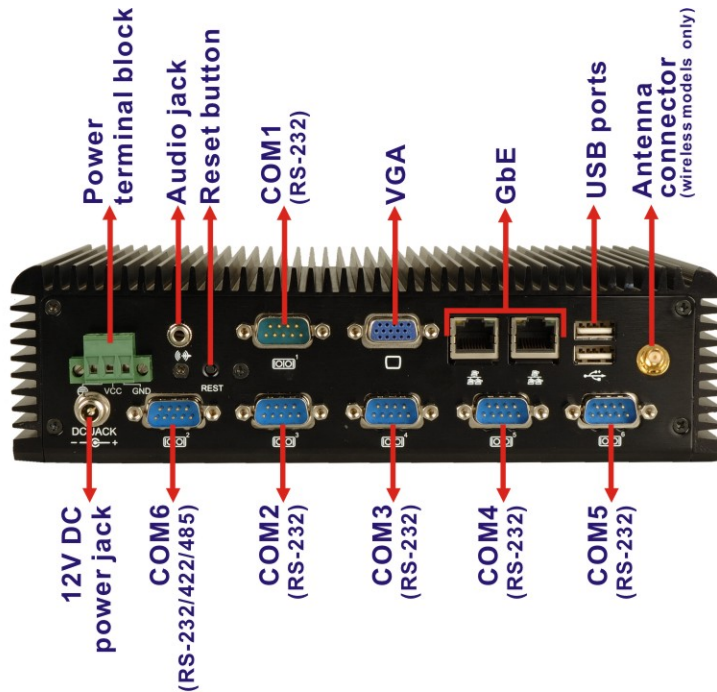

Figure 2-3: ECW-281B-D525 Rear Panel

2.3.2.2 ECW-281B2-D525 Rear Panel

The rear panel of the ECW-281B2-D525 provides access to the following external I/O connectors.

- 2 x USB port connectors
- 2 x RJ-45 Ethernet connector
- 2 x VGA connectors
- 5 x RS-232 serial ports
- 1 x Speaker out
- 1 x 3-pin power terminal block
- 1 x 12V DC power jack
- 1 x Wireless antenna connector (for wireless models only)

An overview of the rear panel is shown in **Figure 2-4**.

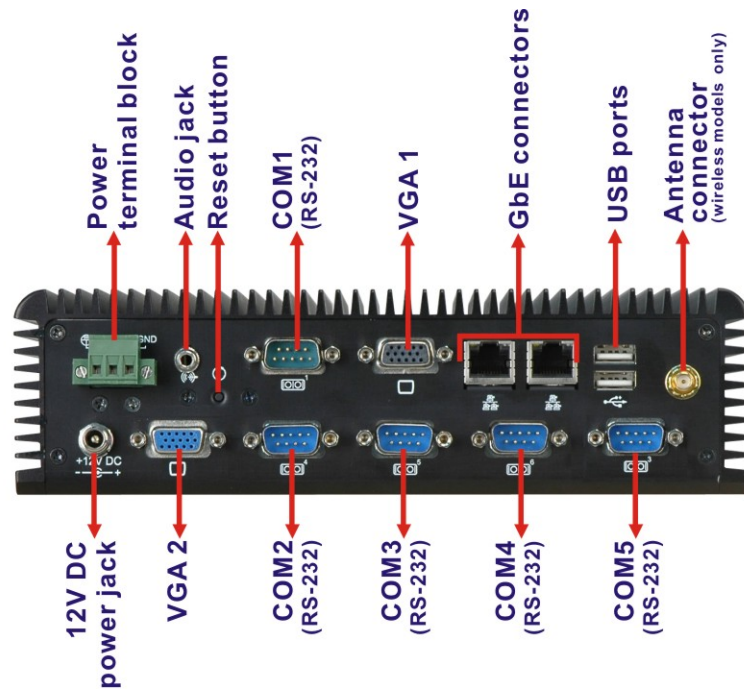

Figure 2-4: ECW-281B2-D525 Rear Panel

2.3.3 Bottom Surface



WARNING:

Never remove the bottom access panel from the chassis while power is still being fed into the system. Before removing the bottom access panel, make sure the system has been turned off and all power connectors unplugged.

The bottom surface of the ECW-281B/B2-D525 contains the retention screw holes for the VESA MIS-D 100 wall-mount kit, two-side mounting brackets and DIN mount bracket.

ECW-281B/B2-D525 Embedded System

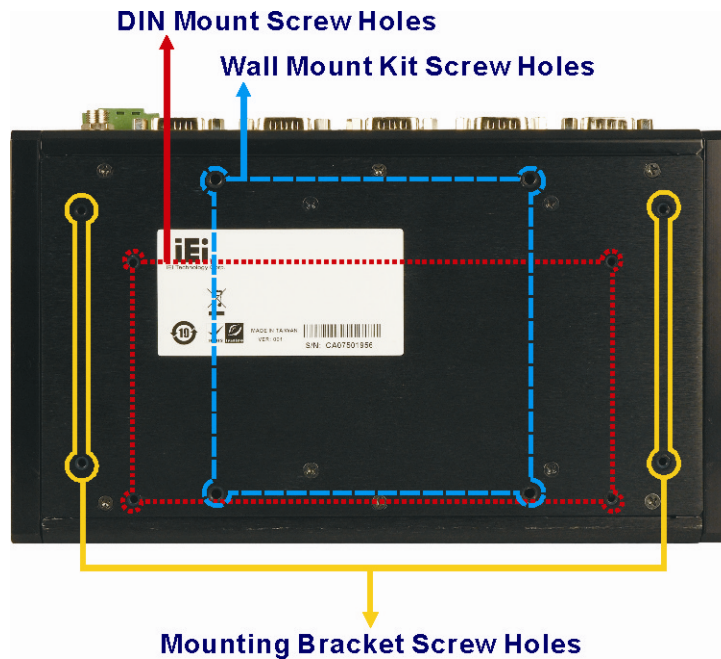

Figure 2-5: Bottom Surface

2.4 Internal Overview

The ECW-281B/B2-D525 internal components are listed below:

- 1 x IEI WAFER motherboard (preinstalled)
- 1 x IEI power module (WD models only)
- 1 x SO-DIMM module (preinstalled)
- 1 x Hard drive bracket and SATA cable support one SATA hard disk

All the components are accessed by removing the bottom surface.



Figure 2-6: Internal Overview



Chapter

3

System Components

3.1 Embedded System Motherboard



NOTE:

The jumpers and connectors shown in the section below are those jumpers and connectors that are relevant to the configuration and installation of the embedded system. For a complete list of jumpers and connectors on the WAFER-PV-D5252 motherboard, please refer to the WAFER-PV-D5252 user manual.

The ECW-281B/B2-D525 models have a WAFER-PV-D5252 motherboard installed in the system. The following sections describe the relevant connectors and jumpers on the motherboard.

3.1.1 WAFER-PV-D5252 Motherboard Overview

The locations of the WAFER-PV-D5252 jumpers and connectors used on the ECW-281B/B2-D525 are shown in **Figure 3-1** below.

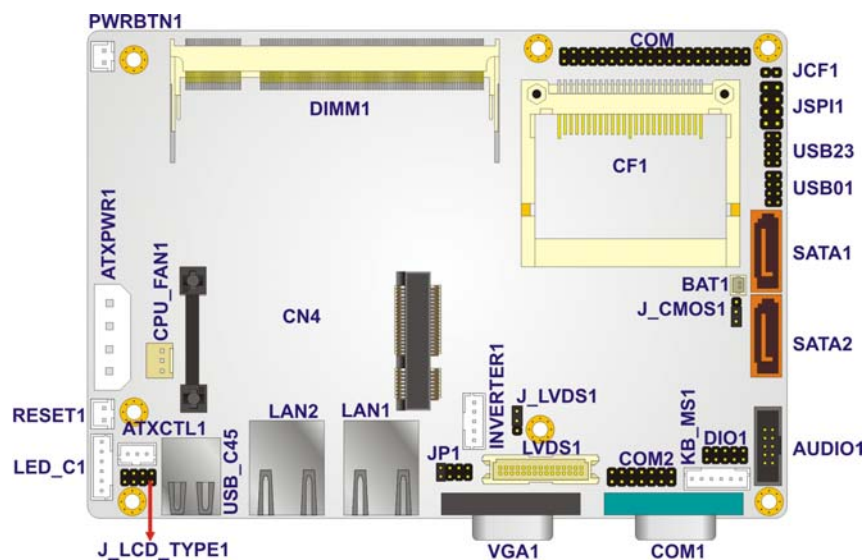

Figure 3-1: WAFER-PV-D5252 Jumper and Connector Locations

3.1.2 CPU Support



NOTE:

The ECW-281B/B2-D525 series has a preinstalled Intel® Atom™ 1.8 GHz CPU on-board. If the CPU fails, the motherboard has to be replaced. Please contact the IEI reseller or vendor you purchased the ECW-281B/B2-D525 from or contact an IEI sales representative directly. To contact an IEI sales representative, please send an email to sales@iei.com.tw.

The ECW-281B/B2-D525 comes with an embedded 45 nm 1.8 GHz Intel® Atom™ processor D525. It is a dual-core processor with 1 MB L2 cache.

3.2 Peripheral Interface Connectors

Section 3.2.1 lists all the peripheral interface connectors seen in **Section 3.1.1**.

3.2.1 Peripheral Interface Connectors

Table 3-1 shows a list of the peripheral interface connectors on the WAFER-PV-D5252 that are used for the ECW-281B/B2-D525. Detailed descriptions of these connectors can be found in **Section 3.3**.

Connector	Type	Label
ATX power connector	4-pin ATX	J1
Audio connector	10-pin box header	AUDIO1
Battery connector	2-pin wafer	BT1
CompactFlash® socket	50-pin CF socket	CF1
LED connector	6-pin header	CN2
PCIe Mini Card slot	PCIe Mini Slot	CN1

ECW-281B/B2-D525 Embedded System

Power button connector	2-pin wafer	PWR_BTN
Reset button connector	2-pin header	RST_BTN
Serial ATA (SATA) drive connectors	7-pin SATA	SATA1
RS-232 serial port connector (COM3 – COM6)	40-pin header	COM
RS-232/422/485 serial port connector	14-pin header	COM2
USB 2.0 connector	8-pin header	USB4

Table 3-1: Peripheral Interface Connectors

3.3 Internal Peripheral Connectors

Internal peripheral connectors are found on the motherboard and are only accessible when the motherboard is outside of the chassis. This section has complete descriptions of the internal, peripheral connectors on the WAFER-PV-D5252 that are used for the ECW-281B/B2-D525.

3.3.1 ATX Power Connector

CN Label:	J1
CN Type:	4-pin power connector (1x4)
CN Location:	See Figure 3-2
CN Pinouts:	See Table 3-2

The 4-pin ATX power connector is connected to a DC-DC power module.

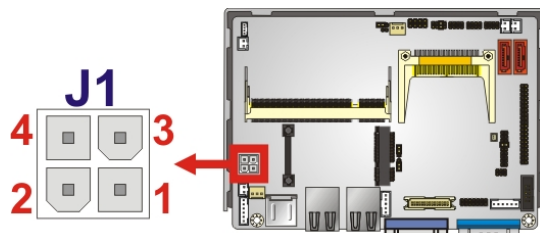

Figure 3-2: ATX Power Connector Location

PIN NO.	DESCRIPTION
1	GND
2	GND
3	+12V
4	+5V

Table 3-2: ATX Power Connector Pinouts

3.3.2 Audio Connector (10-pin)

- CN Label:** AUDIO1
- CN Type:** 10-pin box header
- CN Location:** See **Figure 3-3**
- CN Pinouts:** See **Table 3-3**

The 10-pin audio connector is interfaced to an audio line-out connector and provides output of audio signals from the system.

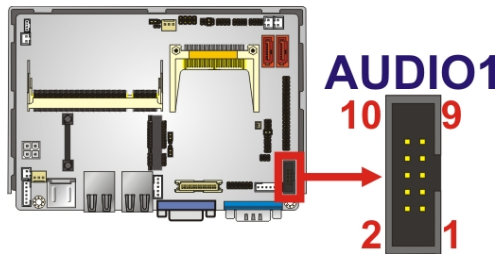
Figure 3-3: Audio Connector Pinouts (10-pin)

PIN NO.	DESCRIPTION	PIN NO.	DESCRIPTION
1	LINE_OUTR	2	LINEIN_R
3	GND_AUDIO	4	GND_AUDIO
5	LINE_OUTL	6	LINEIN_L
7	GND_AUDIO	8	GND_AUDIO
9	MICIN	10	MICIN

Table 3-3: Audio Connector Pinouts (10-pin)

ECW-281B/B2-D525 Embedded System

3.3.3 CompactFlash® Socket

- CN Label:** CF1
- CN Type:** 50-pin header (2x25)
- CN Location:** See **Figure 3-4**
- CN Pinouts:** See **Table 3-4**

A CF Type I or Type II memory card is inserted to the CF socket on the solder side of the ECW-281B/B2-D525.

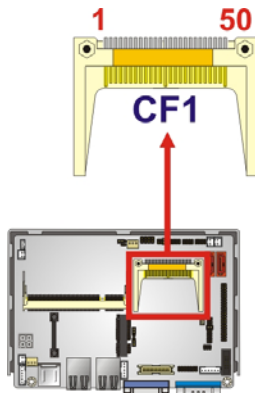

Figure 3-4: CF Card Socket Location

PIN NO.	DESCRIPTION	PIN NO.	DESCRIPTION
1	GND	26	CD1#
2	D3	27	D11
3	D4	28	D12
4	D5	29	D13
5	D6	30	D14
6	D7	31	D15
7	CE#	32	CE2#
8	A10	33	VS1#
9	OE#	34	IOR#
10	A9	35	IOW#
11	A8	36	WE#

PIN NO.	DESCRIPTION	PIN NO.	DESCRIPTION
12	A7	37	IRQ
13	VCC	38	VCC
14	A6	39	CSEL#
15	A5	40	VS2#
16	A4	41	RESET#
17	A3	42	WAIT#
18	A2	43	INPACK#
19	A1	44	REG#
20	A0	45	BVD2
21	D0	46	BVD1
22	D1	47	D8
23	D2	48	D9
24	IOCS16#	49	D10
25	CD2#	50	GND2

Table 3-4: CF Card Socket Pinouts

3.3.4 LED Connector

- CN Label:** CN2
- CN Type:** 6-pin wafer (1x6)
- CN Location:** See **Figure 3-5**
- CN Pinouts:** See **Table 3-5**

The LED connector connects to an HDD indicator LED and a power LED on the system chassis to inform the user about HDD activity and the power on/off status of the system.

ECW-281B/B2-D525 Embedded System

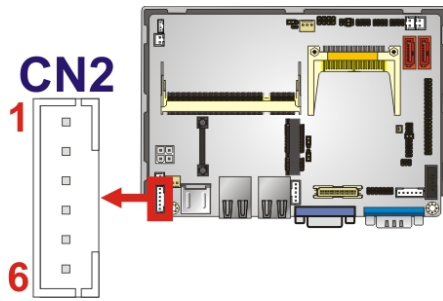

Figure 3-5: LED Connector Locations

	Pin	Description
+5 V Power Output	1	+5 V
	2	GND
Power LED	3	VCC
	4	GND
HDD LED	5	VCC
	6	-HDLED

Table 3-5: LED Connector Pinouts

3.3.5 PCIe Mini Card Slot

- CN Label:** CN1
- CN Type:** 52-pin Mini PCIe Card Slot
- CN Location:** See **Figure 3-6**
- CN Pinouts:** See **Table 3-6**

The PCIe mini card slot enables a PCIe mini card expansion module to be connected to the board. Cards supported include among others wireless LAN (WLAN) cards.

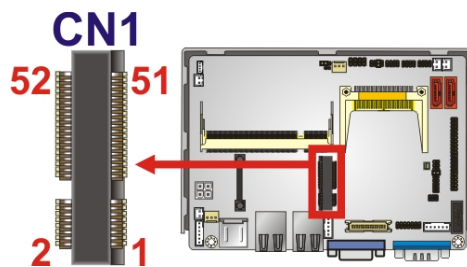
Figure 3-6: PCIe Mini Card Slot Location

PIN NO.	DESCRIPTION	PIN NO.	DESCRIPTION
1	PCIE_WAKE#	2	VCC3
3	N/C	4	GND
5	N/C	6	1.5V
7	CLKREQ#	8	LFRAME#
9	GND	10	LAD3
11	CLK-	12	LAD2
13	CLK+	14	LAD1
15	GND	16	LAD0
17	PCIRST#	18	GND
19	LPC	20	VCC3
21	GND	22	PCIRST#
23	PERN2	24	3VDual
25	PERP2	26	GND
27	GND	28	1.5V
29	GND	30	SMBCLK
31	PETN2	32	SMBDATA
33	PETP2	34	GND
35	GND	36	USBD-
37	N/C	38	USBD+
39	N/C	40	GND
41	N/C	42	N/C
43	N/C	44	RF_LINK#
45	N/C	46	BLUELED#
47	N/C	48	1.5V
49	N/C	50	GND

ECW-281B/B2-D525 Embedded System

51	N/C	52	VCC3
----	-----	----	------

Table 3-6: PCIe Mini Card Slot Pinouts

3.3.6 Power Button Connector

CN Label:	PWR_BTN
CN Type:	2-pin wafer (1x2)
CN Location:	See Figure 3-7
CN Pinouts:	See Table 3-7

The power button connector is connected to a power switch on the system chassis to enable users to turn the system on and off.

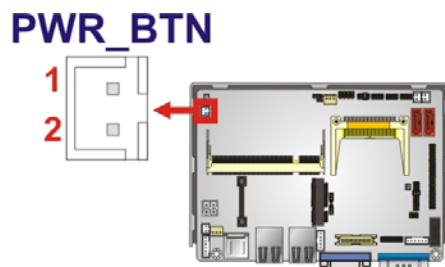

Figure 3-7: Power Button Connector Location

PIN NO.	DESCRIPTION
1	Power Switch-
2	GND

Table 3-7: Power Button Connector Pinouts

3.3.7 Reset Button Connector

CN Label:	RST_BTN
CN Type:	2-pin wafer (1x2)
CN Location:	See Figure 3-8

CN Pinouts: See **Table 3-8**

The reset button connector is connected to a reset switch on the system chassis to enable users to reboot the system when the system is turned on.

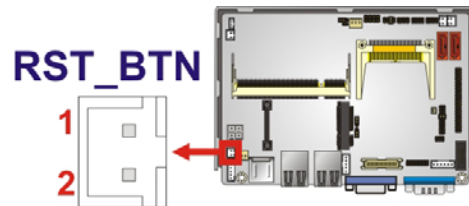

Figure 3-8: Reset Button Connector Locations

PIN NO.	DESCRIPTION
1	Reset Switch
2	GND

Table 3-8: Reset Button Connector Pinouts

3.3.8 SATA Drive Connectors

CN Label: **SATA1, SATA2**

CN Type: 7-pin SATA drive connectors

CN Location: See **Figure 3-9**

CN Pinouts: See **Table 3-9**

The SATA connectors connect to SATA hard drives or optical drives.

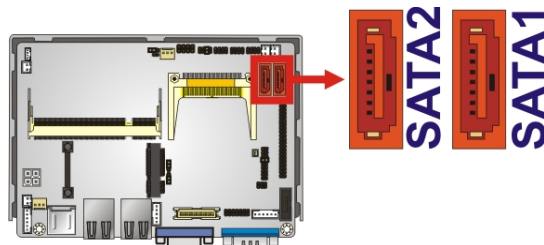

Figure 3-9: SATA Drive Connector Locations

ECW-281B/B2-D525 Embedded System

PIN NO.	DESCRIPTION
1	GND
2	TX+
3	TX-
4	GND
5	RX-
6	RX+
7	GND

Table 3-9: SATA Drive Connector Pinouts

3.3.9 Serial Port Connector (COM3, COM4, COM5 and COM6)

CN Label:	COM
CN Type:	40-pin header (2x20)
CN Location:	See Figure 3-10
CN Pinouts:	See Table 3-10

The 40-pin serial port connector contains the following four serial ports: COM3, COM4, COM5 and COM6. All these serial ports are RS-232 serial communications channels. The serial port locations are specified below.

- COM3 is located on pin 1 to pin 10
- COM4 is located on pin 11 to pin 20
- COM5 is located on pin 21 to pin 30
- COM6 is located on pin 31 to pin 40

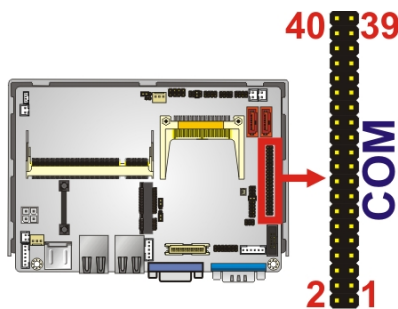

Figure 3-10: COM3 to COM6 Connector Pinout Locations

PIN NO.	DESCRIPTION	PIN NO.	DESCRIPTION
1	DATA CARRIER DETECT (DCD3)	2	DATA SET READY (DSR3)
3	RECEIVE DATA (RXD3)	4	REQUEST TO SEND (RTS3)
5	TRANSMIT DATA (TXD3)	6	CLEAR TO SEND (CTS3)
7	DATA TERMINAL READY (DTR3)	8	RING INDICATOR (RI3)
9	GND	10	GND
11	DATA CARRIER DETECT (DCD4)	12	DATA SET READY (DSR4)
13	RECEIVE DATA (RXD4)	14	REQUEST TO SEND (RTS4)
15	TRANSMIT DATA (TXD4)	16	CLEAR TO SEND (CTS4)
17	DATA TERMINAL READY (DTR4)	18	RING INDICATOR (RI4)
19	GND	20	GND
21	DATA CARRIER DETECT (DCD5)	22	DATA SET READY (DSR5)
23	RECEIVE DATA (RXD5)	24	REQUEST TO SEND (RTS5)
25	TRANSMIT DATA (TXD5)	26	CLEAR TO SEND (CTS5)
27	DATA TERMINAL READY (DTR5)	28	RING INDICATOR (RI5)
29	GND	30	GND
31	DATA CARRIER DETECT (DCD6)	32	DATA SET READY (DSR6)
33	RECEIVE DATA (RXD6)	34	REQUEST TO SEND (RTS6)
35	TRANSMIT DATA (TXD6)	36	CLEAR TO SEND (CTS6)
37	DATA TERMINAL READY (DTR6)	38	RING INDICATOR (RI6)
39	GND	40	GND

Table 3-10: COM3 to COM6 Connector Pinouts

3.3.10 Serial Port Connector (COM 2)(RS-232, RS-422 or RS-485)

- CN Label:** COM2
- CN Type:** 14-pin header (2x7)
- CN Location:** See **Figure 3-11**
- CN Pinouts:** See **Table 3-11**

The 14-pin serial port connector connects to the COM2 serial communications channels. COM2 is a multi function channel. In default mode COM2 is an RS-232 serial

ECW-281B/B2-D525 Embedded System

communication channel but, with the COM2 function select jumper, can be configured as either an RS-422 or RS-485 serial communications channel.

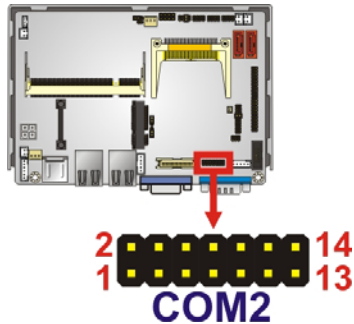

Figure 3-11: RS-232/422/485 Serial Port Connector Location

PIN NO.	DESCRIPTION	PIN NO.	DESCRIPTION
1	NDCD	2	NDSR2
3	NRX	4	NRTS2
5	NTX	6	NCTS2
7	NDTR	8	NRI2
9	GND	10	GND
11	TXD485+	12	TXD485-
13	RXD485+	14	RXD485-

Table 3-11: RS-232/RS-485 Serial Port Connector Pinouts

3.3.11 USB Connectors (Internal)

CN Label:	USB4
CN Type:	8-pin header (2x4)
CN Location:	See Figure 3-12
CN Pinouts:	See Table 3-12

The 2x4 USB pin connectors each provide connectivity to two USB 1.1 or two USB 2.0 ports. Each USB connector can support two USB devices. Additional external USB ports are found on the rear panel. The USB ports are used for I/O bus expansion.

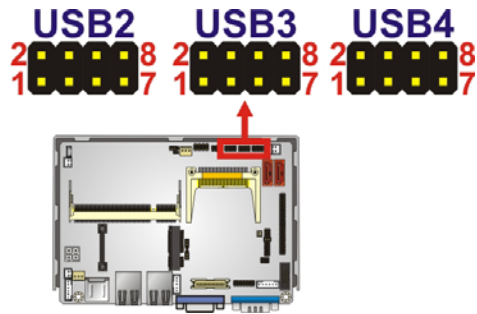

Figure 3-12: USB Connector Pinout Locations

PIN NO.	DESCRIPTION	PIN NO.	DESCRIPTION
1	VCC	2	GND
3	DATA-	4	DATA+
5	DATA+	6	DATA-
7	GND	8	VCC

Table 3-12: USB Port Connector Pinouts

Chapter

4

Installation

4.1 Anti-static Precautions



WARNING:

If the following anti-static precautions are not followed, a user may be injured and the system irreparably damaged.

Electrostatic discharge (ESD) can cause serious damage to electronic components, including the WAFER series motherboard and the power module. (Dry climates are especially susceptible to ESD.) It is therefore critical that whenever the ECW-281B/B2-D525 is opened and any electrical component handled, the following anti-static precautions are strictly adhered to.

- **Wear an anti-static wristband:** - Wearing a simple anti-static wristband can help to prevent ESD from damaging the board.
- **Self-grounding:** - Before handling the board, touch any grounded conducting material. During the time the board is handled, frequently touch any conducting materials that are connected to the ground.

4.2 Installation Procedure

4.2.1 Installation Procedure Overview

To properly install the ECW-281B/B2-D525, the following steps must be followed. Detailed descriptions of these instructions are listed in the sections that follow.

Step 1: Unpacking

Step 2: Configure the jumper settings

Step 3: Install the SATA hard disk drive (HDD)

Step 4: Mount the ECW-281B/B2-D525







Step 5: Connect the front panel peripheral connectors

ECW-281B/B2-D525 Embedded System

Step 6: Power the system up

4.2.2 Unpacking

After the ECW-281B/B2-D525 is received make sure the following components are included in the package. If any of these components are missing, please contact the ECW-281B/B2-D525 reseller or vendor where it was purchased or contact an IEI sales representative immediately.

Quantity	Item	Image
1	ECW-281B/B2-D525 embedded system	
2	Mounting brackets	
1	Screw set	
1	DIN mount kit	
1	SATA and power cable	
1	Thermal pad for HDD	
1	Quick installation guide	

1	Driver and manual CD	
1	Wireless antenna (wireless model only)	
1	Power cord (optional for WD models)	
1	Power adapter with ERP and PSE certificates (optional for WD models) (P/N: 63000-FSP060DBAB1552-RS)	
1	VESA MIS-D 100 wall mount kit (optional)	

Table 4-1: Package List Contents

4.2.3 Bottom Surface Removal

WARNING:

Over-tightening bottom cover screws will cause damage to the bottom surface. Maximum torque for cover screws is 5 kg-cm (0.36 lb-ft/0.49 Nm).

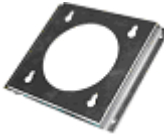
Before the jumper settings can be configured and the hard disk drive can be installed, the bottom surface must be removed. To remove the bottom surface, please follow the steps below:

- Step 1:** Remove the bottom surface retention screws. The bottom surface is secured to the chassis with six retention screws (**Figure 4-1**). All six screws must be removed.

ECW-281B/B2-D525 Embedded System



Figure 4-1: Bottom Surface Retention Screws

Step 2: Gently remove the bottom surface from the ECW-281B/B2-D525.

4.2.4 Configure the Jumper Settings

To configure the jumper settings, please follow the steps below.

Step 1: Remove the bottom surface. See **Section 4.2.3**.

Step 2: Locate the jumper settings on the embedded motherboard. See **Chapter 4.2.4.1**.

Step 3: Make the jumper settings in accordance with the settings described and defined in **Chapter 4.2.4.1**.

4.2.4.1 Jumpers



NOTE:

A jumper is a metal bridge used to close an electrical circuit. It consists of two or three metal pins and a small metal clip (often protected by a plastic cover) that slides over the pins to connect them. To CLOSE/SHORT a jumper means connecting the pins of the jumper with the plastic clip and to OPEN a jumper means removing the plastic clip from a jumper.

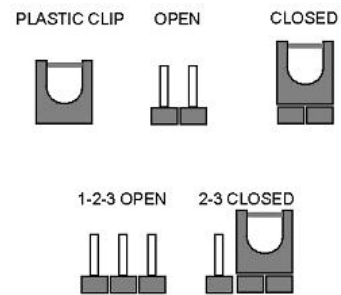

Figure 4-2: Jumpers

The WAFER-PV-D5252 motherboard has several onboard jumpers (**Table 4-2**).

Description	Label	Type
Clear CMOS	J_CMOS1	3-pin header
CompactFlash® master/slave selection	JCF1	2-pin header
COM2 RS-232/422/485 selection	JP1	8-pin header
COM1 pin-9 voltage selection	JP2	6-pin header

Table 4-2: Jumpers

ECW-281B/B2-D525 Embedded System

4.2.4.2 CF Card Setup

Jumper Label:	JCF1
Jumper Type:	2-pin header
Jumper Settings:	See Table 4-3
Jumper Location:	See Figure 4-3

The CF Card Setup jumper sets the CF Type I card or CF Type II cards as either the slave device or the master device. CF Card Setup jumper settings are shown in Table 4-3.

CF Card Setup	Description	
OFF	Slave	Default
Short 1-2	Master	

Table 4-3: CF Card Setup Jumper Settings

The CF Card Setup jumper location is shown in Figure 4-3.

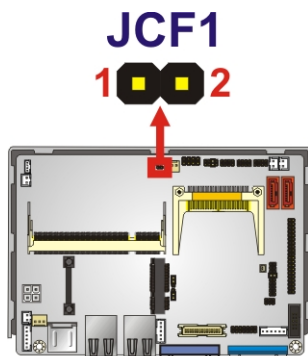

Figure 4-3: CF Card Setup Jumper Location

4.2.4.3 Clear CMOS Jumper

Jumper Label:	J_CMOS1
Jumper Type:	3-pin header
Jumper Settings:	See Table 4-4
Jumper Location:	See Figure 4-4

If the ECW-281B/B2-D525 fails to boot due to improper BIOS settings, the clear CMOS jumper clears the CMOS data and resets the system BIOS information. To do this, use the jumper cap to close pins 2 and 3 for a few seconds then reinstall the jumper clip back to pins 1 and 2.

If the “CMOS Settings Wrong” message is displayed during the boot up process, the fault may be corrected by pressing the F1 to enter the CMOS Setup menu. Do one of the following:

- Enter the correct CMOS setting
- Load Optimal Defaults
- Load Failsafe Defaults.

After having done one of the above, save the changes and exit the CMOS Setup menu.

The clear CMOS jumper settings are shown in **Table 4-4**.

Clear CMOS	Description	
Short 1 - 2	Keep CMOS Setup	Default
Short 2 - 3	Clear CMOS Setup	

Table 4-4: Clear CMOS Jumper Settings

The location of the clear CMOS jumper is shown in **Figure 4-4** below.

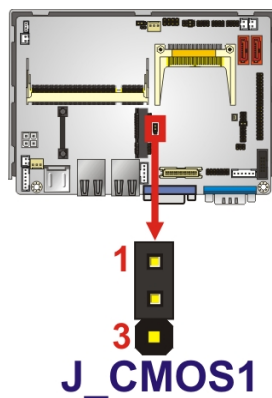

Figure 4-4: Clear CMOS Jumper

ECW-281B/B2-D525 Embedded System

4.2.4.4 COM 6 Function Select Jumper (ECW-281B-D525 Series Only)

Jumper Label:	JP1
Jumper Type:	8-pin header
Jumper Settings:	See Table 4-5
Jumper Location:	See Figure 4-5

The COM 6 Function Select jumper sets the communication protocol used by the second serial communications port (COM 6) as RS-232, RS-422 or RS-485. The COM 6 Function Select settings are shown in **Table 4-5**.

COM 6 Function Select	Description	
Short 1-2	RS-232	Default
Short 3-4	RS-422	
Short 5-6	RS-485	
Short 5-6 Short 7-8	RS-485 with RTS control	

Table 4-5: COM 6 Function Select Jumper Settings

The COM 6 Function Select jumper location is shown in **Figure 4-5**.

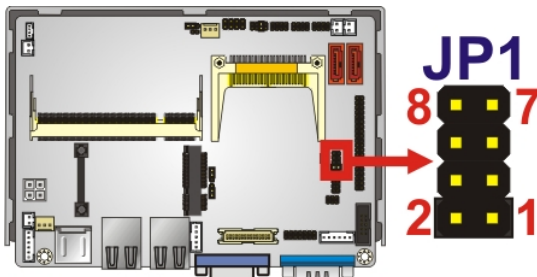

Figure 4-5: COM 2 Function Select Jumper Location

4.2.4.5 COM 1 Pin 9 Setting Jumper

- Jumper Label:** JP2
- Jumper Type:** 6-pin header
- Jumper Settings:** See Table 4-6
- Jumper Location:** See Figure 4-6

The COM 1 Pin 9 Setting jumper configures pin 9 on COM 1 as either a +5 V, +12 V power source or as a ring-in (RI) line. The COM 1 Pin 9 Setting jumper selection options are shown in Table 4-6.

Setting	Description
Short 1-3	COM 1 RI Pin use +5 V
Short 3-5	COM 1 RI Pin use +12 V
Short 3-4	COM 1 RI Pin use RI (Default)

Table 4-6: COM 1 Pin 9 Setting Jumper Settings

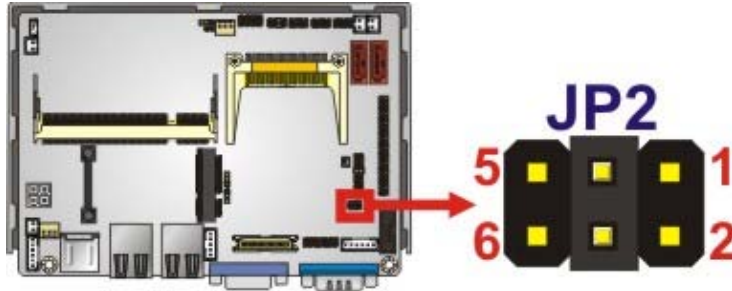

Figure 4-6: COM 1 Pin 9 Setting Jumper Location

ECW-281B/B2-D525 Embedded System

4.2.5 Hard Drive Installation

One 2.5" SATA hard drive supported. The SATA drive is installed into a hard drive bracket attached on the inside of the bottom panel (**Figure 4-7**).



Figure 4-7: Hard Drive Bracket

To install the hard drive into the system, please follow the steps below.

- Step 1:** Remove the bottom surface See Section 4.2.3.
- Step 2:** Remove the hard drive bracket from the bottom surface by removing the four retention screws that secure the bracket to the bottom surface. (**Figure 4-8**)



Figure 4-8:HDD Bracket Retention Screws

- Step 3:** Place the HDD into the bracket.

Step 4: Align the retention screw holes in the HDD with those in the bottom of the bracket.

Step 5: Secure the HDD with the bracket by inserting four retention screws into the bottom of the bracket (**Figure 4-9**).



Figure 4-9: HDD Retention Screws

Step 6: Locate the breather hole of the HDD. Cut off the corresponding area of the breather hole from the thermal pad.

Step 7: Adhere the thermal pad to the HDD. Make sure there is no obstacle covering the breather hole (**Figure 4-10**).



CAUTION:

Make sure the breather hole of the HDD is not covered. Covering the breather hole may cause damage to the HDD.

ECW-281B/B2-D525 Embedded System

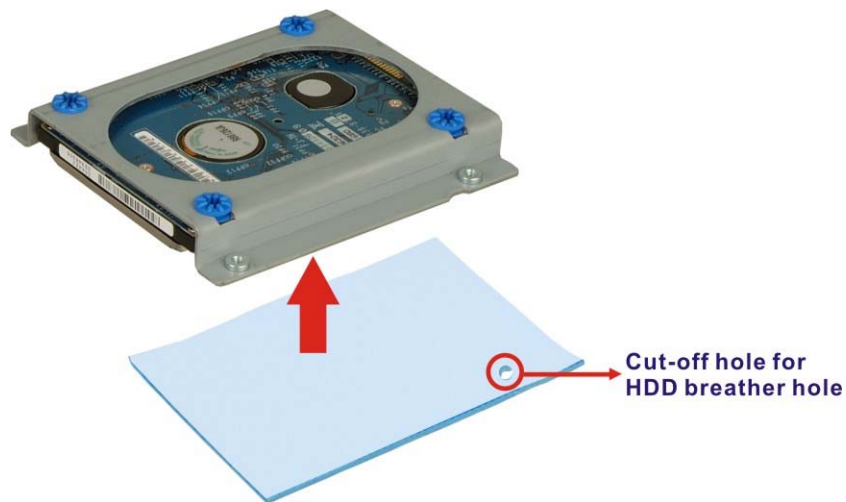

Figure 4-10: HDD Thermal Pad

- Step 8:** Replace the HDD bracket onto the bottom surface by aligning the four retention screw holes in the HDD bracket with those in the back of the bottom surface.
- Step 9:** Reinsert the four previously removed retention screws.
- Step 10:** Connect the SATA cable connector in the ECW-281B/B2-D525 to the HDD.
- Step 11:** Replace the bottom surface to the bottom panel by reinserting the six previously removed retention screws.



WARNING:

Over-tightening bottom cover screws will cause damage to the bottom surface. Maximum torque for cover screws is 5 kg-cm (0.36 lb-ft/0.49 Nm).

4.2.6 Mounting the System with Mounting Brackets

To mount the embedded system onto a wall or some other surface using the two mounting brackets, please follow the steps below.

- Step 1:** Turn the embedded system over.
- Step 2:** Align the two retention screw holes in each bracket with the corresponding retention screw holes on the sides of the bottom surface.
- Step 3:** Secure the brackets to the system by inserting two retention screws into each bracket.

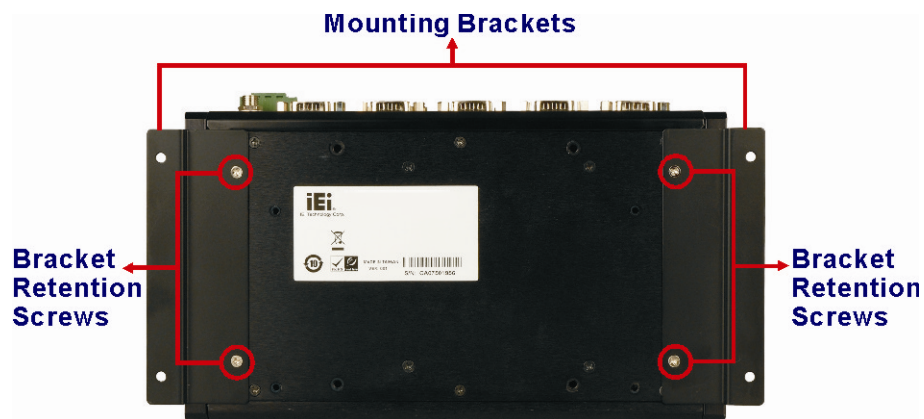

Figure 4-11: Mounting Bracket Retention Screws

- Step 4:** Drill holes in the intended installation surface.
- Step 5:** Align the mounting holes in the sides of the mounting brackets with the predrilled holes in the mounting surface.
- Step 6:** Insert four retention screws, two in each bracket, to secure the system to the wall.

4.2.7 Mounting the System with Wall Mount Kit

To mount the embedded system onto a wall using the VESA MIS-D 100 wall mount kit, please follow the steps below.

- Step 1:** Select the location on the wall for the wall-mounting bracket.

ECW-281B/B2-D525 Embedded System

- Step 2:** Carefully mark the locations of the four bracket screw holes on the wall.
- Step 3:** Drill four pilot holes at the marked locations on the wall for the bracket retention screws.
- Step 4:** Align the wall-mounting bracket screw holes with the pilot holes.
- Step 5:** Secure the mounting-bracket to the wall by inserting the retention screws into the four pilot holes and tightening them (**Figure 4-12**).

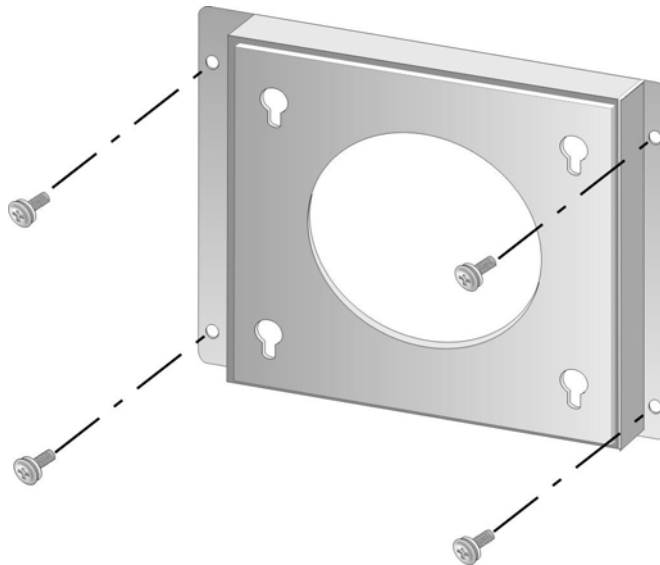

Figure 4-12: Wall-mounting Bracket

- Step 6:** Insert the four monitor mounting screws provided in the wall mounting kit into the four screw holes on the bottom panel of the system and tighten until the screw shank is secured against the bottom panel (760H760H Figure 4-13).
- Step 7:** Align the mounting screws on the ECW-281B/B2-D525 bottom panel with the mounting holes on the bracket.
- Step 8:** Carefully insert the screws through the holes and gently pull the monitor downwards until the ECW-281B/B2-D525 rests securely in the slotted holes (**Figure 4-13**). Ensure that all four of the mounting screws fit snugly into their respective slotted holes.



NOTE:

In the diagram below the bracket is already installed on the wall.

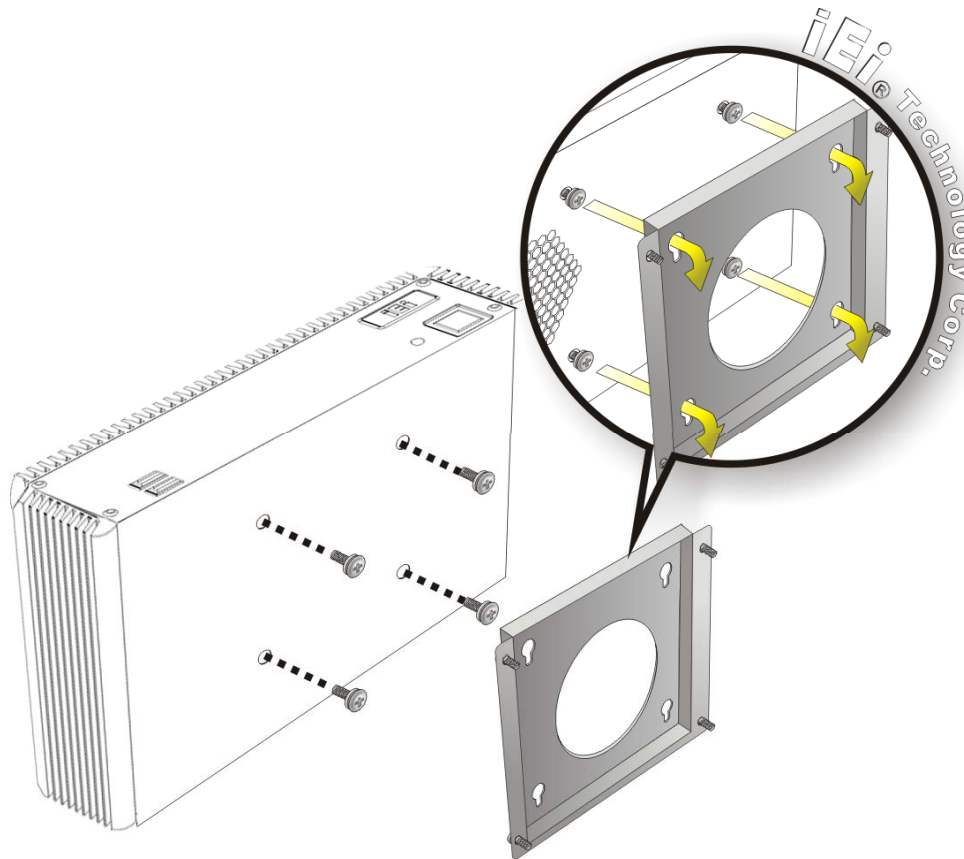

Figure 4-13: Mount the Embedded System

4.2.8 DIN Mounting

To mount the ECW-281B/B2-D525 embedded system onto a DIN rail, please follow the steps below.

ECW-281B/B2-D525 Embedded System

Step 1: Attach the DIN rail mounting bracket to the bottom panel of the embedded system. Secure the bracket to the embedded system with the supplied retention screws (**Figure 4-14**).

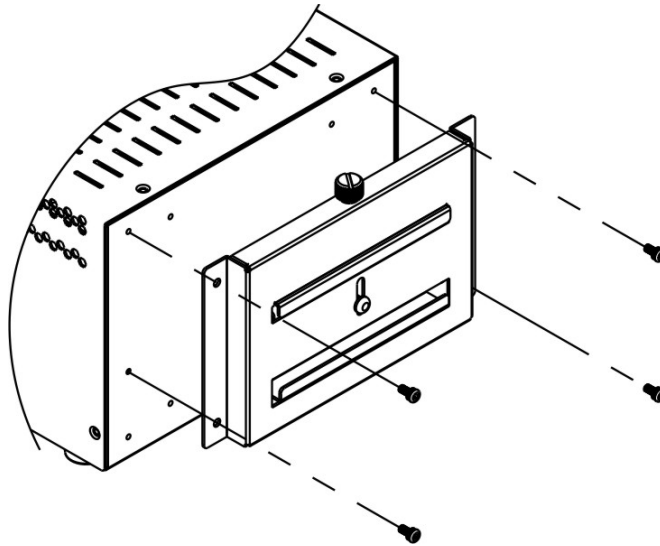

Figure 4-14: DIN Rail Mounting Bracket

Step 2: Make sure the inserted screw in the center of the bracket is at the lowest position of the elongated hole (**Figure 4-15**).

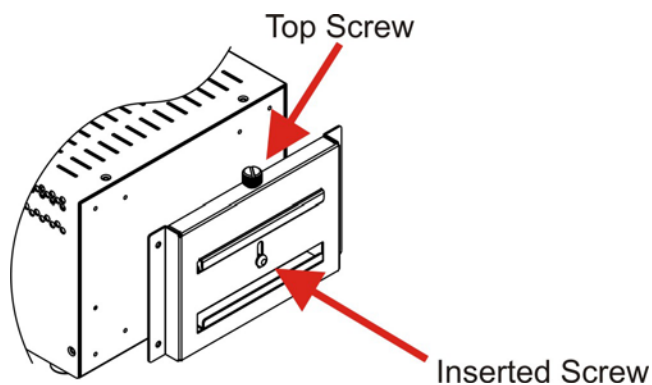

Figure 4-15: Screw Locations

Step 3: Place the DIN rail flush against the back of the mounting bracket making sure the edges of the rail are between the upper and lower clamps (**Figure 4-16**).

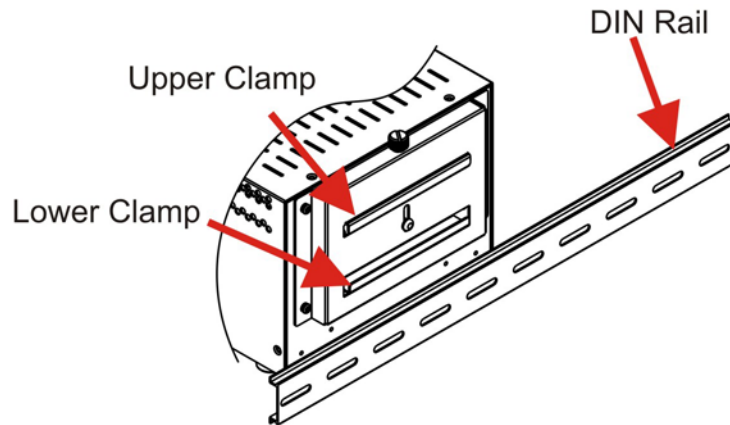

Figure 4-16: Mounting the DIN RAIL

- Step 4:** Secure the DIN rail to the mounting bracket by turning the top screw clockwise. This draws the lower clamp up and secures the embedded system to the DIN rail (Figure 4-17).

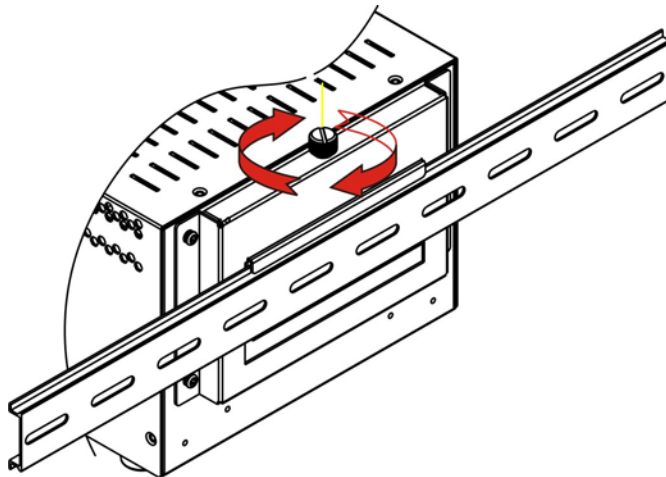

Figure 4-17: Secure the Assembly to the DIN Rail

4.2.9 Wireless Antenna Installation (Wireless Models Only)

To install an antenna to the wireless ECW-281B/B2-D525 series for efficient wireless network transmission, follow the steps below.

- Step 1:** Locate the antenna connector on the rear panel of the embedded system (refer to Figure 2-3).
- Step 2:** Install the antenna to the antenna connector (Figure 4-18).

ECW-281B/B2-D525 Embedded System



Figure 4-18: Wireless Antenna Installation

4.2.10 Cable Connections

Once the system has been mounted on the wall, the following connectors can be connected to the system.

- VGA cable connector
- Serial port connectors
- RJ-45 connectors
- USB devices can be connected to the system.

The cable connection locations are shown in **Figure 2-3**.

4.3 Power-On Procedure

4.3.1 Installation Checklist



WARNING:

Make sure a power supply with the correct input voltage is being fed into the system. Incorrect voltages applied to the system may cause damage to the internal electronic components and may also cause injury to the user.

To power on the embedded system please make sure of the following:

- The bottom surface panel is installed

- All peripheral devices (VGA monitor, serial communications devices etc.) are connected
- The power cables are plugged in
- The system is securely mounted

4.3.2 Terminal Block Pinouts

The terminal block pinouts are shown in **Figure 4-19**.

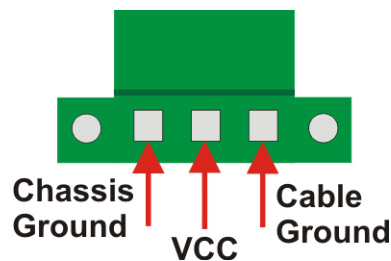

Figure 4-19: Terminal Block Pinouts

The chassis ground is connected to the ECW chassis internally. The cable ground is connected to the ground pin on the input power connector of the power module.

4.3.3 Power-on Procedure

To power-on the ECW-281B/B2-D525 please follow the steps below:

Step 1: Push the power button.

Step 2: Once turned on, the power button should turn to blue. See **Figure 4-20**.

ECW-281B/B2-D525 Embedded System



Figure 4-20: Power Button

Chapter

6

BIOS

5.1 Introduction

The BIOS is programmed onto the BIOS chip. The BIOS setup program allows changes to certain system settings. This chapter outlines the options that can be changed.

5.1.1 Starting Setup

The UEFI BIOS is activated when the computer is turned on. The setup program can be activated in one of two ways.

1. Press the **F2** key as soon as the system is turned on or
2. Press the **F2** key when the “**Press F2 to enter SETUP**” message appears on the screen.

If the message disappears before the **F2** key is pressed, restart the computer and try again.

5.1.2 Using Setup

Use the arrow keys to highlight items, press **ENTER** to select, use the PageUp and PageDown keys to change entries, press **F1** for help and press **Esc** to quit. Navigation keys are shown in.

Key	Function
Up arrow	Move to the item above
Down arrow	Move to the item below
Left arrow	Move to the item on the left hand side
Right arrow	Move to the item on the right hand side
+	Increase the numeric value or make changes
-	Decrease the numeric value or make changes
Page up	Move to the next page
Page down	Move to the previous page

Key	Function
Esc	Main Menu – Quit and do not save changes into CMOS Status Page Setup Menu and Option Page Setup Menu -- Exit current page and return to Main Menu
F1	General help, only for Status Page Setup Menu and Option Page Setup Menu
F9	Load optimized defaults
F10	Save changes and Exit BIOS

Table 5-1: BIOS Navigation Keys

5.1.3 Getting Help

When **F1** is pressed a small help window describing the appropriate keys to use and the possible selections for the highlighted item appears. To exit the Help Window press **Esc** or the **F1** key again.

5.1.4 Unable to Reboot After Configuration Changes

If the computer cannot boot after changes to the system configuration is made, CMOS defaults. Use the jumper described in Chapter 4.

5.1.5 BIOS Menu Bar

The **menu bar** on top of the BIOS screen has the following main items:

- Main – Changes the basic system configuration.
- Advanced – Changes the advanced system settings.
- Chipset – Changes the chipset settings.
- Boot – Changes the system boot configuration.
- Security – Sets User and Supervisor Passwords.
- Save & Exit – Selects exit options and loads default settings

The following sections completely describe the configuration options found in the menu items at the top of the BIOS screen and listed above.

ECW-281B/B2-D525 Embedded System

5.2 Main

The **Main** BIOS menu (**BIOS Menu 1**) appears when the **BIOS Setup** program is entered. The **Main** menu gives an overview of the basic system information.

```

Aptio Setup Utility - Copyright (C) 2010 American Megatrends, Inc.
Main  Advanced  Chipset  Boot  Security  Save & Exit

BIOS Information
BIOS Vendor                American Megatrends
Core Version                4.6.4.0 0.20
Compliancy                 UEFI 2.0
Project Version            E338AR14.ROM
Build Date                 09/03/2010 15:39:09

System Date                [Tue 05/06/2008]
System Time                [14:20:27]

Access Level               Administrator

Set the Time. Use Tab to
switch between Time
elements.

-----

<->: Select Screen
↑ ↓: Select Item
EnterSelect
F1  General Help
F2  Previous Values
F3  Optimized Defaults
F4  Save
ESC Exit

Version 2.02.1205. Copyright (C) 2010 American Megatrends, Inc.
  
```

BIOS Menu 1: Main

→ BIOS Information

The **BIOS Information** lists a brief summary of the BIOS. The fields in **BIOS Information** cannot be changed. The items shown in the system overview include:

- **BIOS Vendor:** Installed BIOS vendor
- **Core Version:** Current BIOS version
- **Project Version:** the board version
- **Build Date:** Date the current BIOS version was made

The System Overview field also has two user configurable fields:

→ System Date [xx/xx/xx]

Use the **System Date** option to set the system date. Manually enter the day, month and year.

→ **System Time [xx:xx:xx]**

Use the **System Time** option to set the system time. Manually enter the hours, minutes and seconds.

5.3 Advanced

Use the **Advanced** menu (**BIOS Menu 2**) to configure the CPU and peripheral devices through the following sub-menus:



WARNING!

Setting the wrong values in the sections below may cause the system to malfunction. Make sure that the settings made are compatible with the hardware.

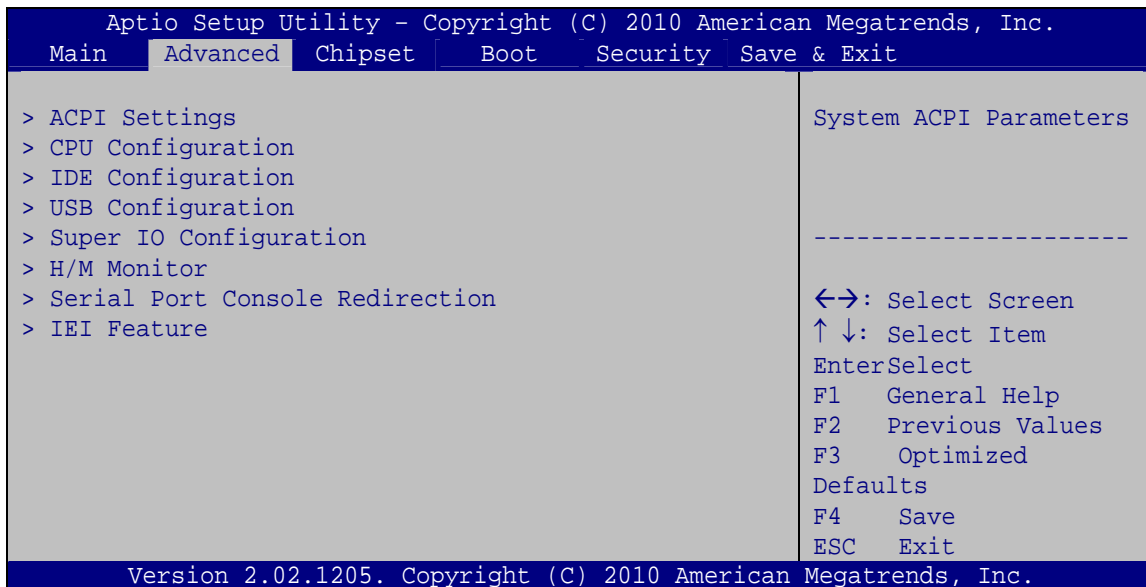

BIOS Menu 2: Advanced

5.3.1 ACPI Configuration

The **ACPI Configuration** menu (**BIOS Menu 3**) configures the Advanced Configuration and Power Interface (ACPI) options.

ECW-281B/B2-D525 Embedded System

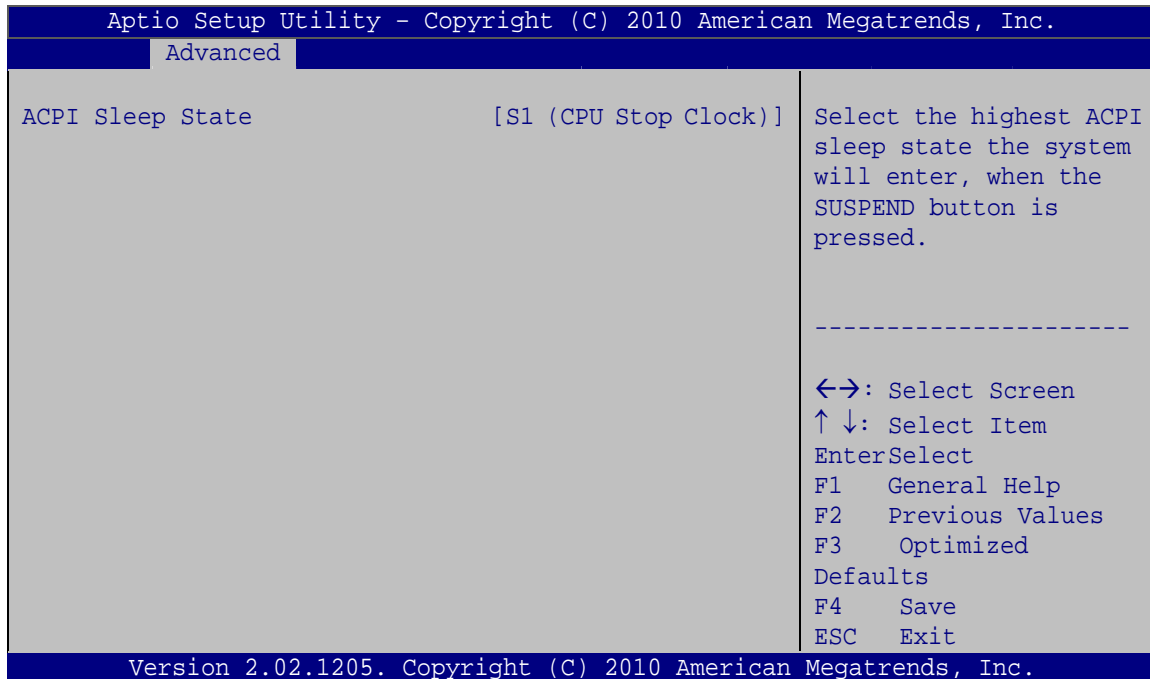

BIOS Menu 3: ACPI Configuration

→ ACPI Sleep State [S1 (CPU Stop Clock)]

Use the **ACPI Sleep State** option to specify the sleep state the system enters when it is not being used.

- **S1 (CPU Stop Clock)** **DEFAULT** The system enters S1(POS) sleep state. The system appears off. The CPU is stopped; RAM is refreshed; the system is running in a low power mode.
- **S3 (Suspend to RAM)** The caches are flushed and the CPU is powered off. Power to the RAM is maintained. The computer returns slower to a working state, but more power is saved.

5.3.2 CPU Configuration

Use the **CPU Configuration** menu (**BIOS Menu 4**) to view detailed CPU specifications and configure the CPU.

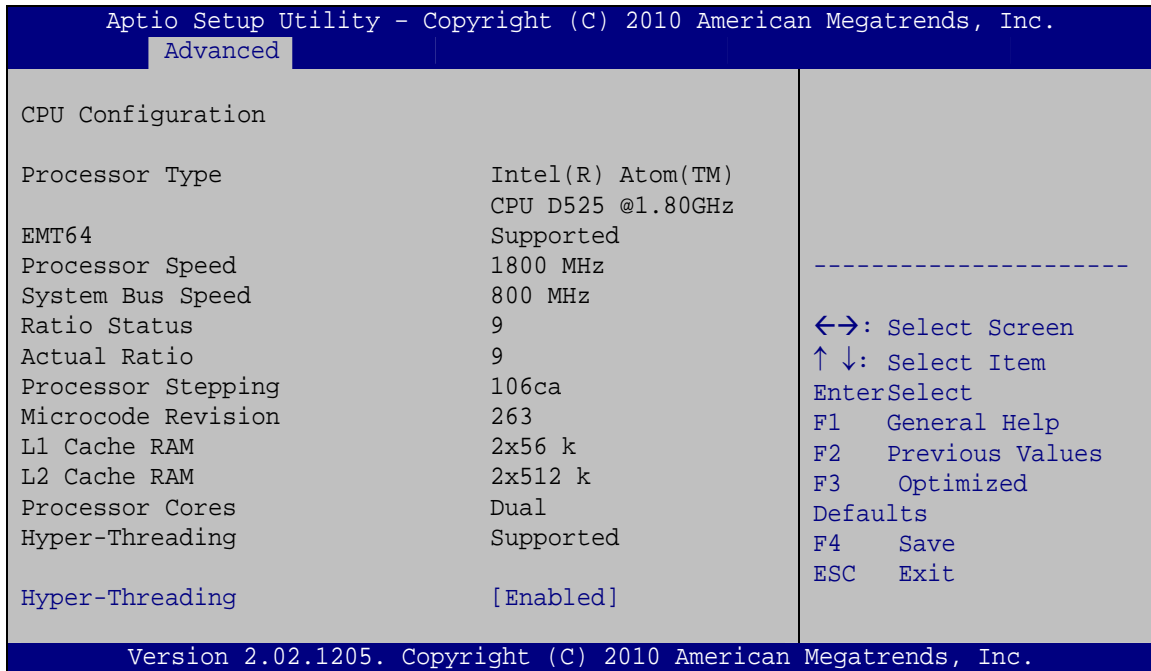

BIOS Menu 4: CPU Configuration

The CPU Configuration menu (**BIOS Menu 4**) lists the following CPU details:

- Processor Type: Lists the brand name of the CPU being used
- EMT64: Indicates if the EM64T is supported by the CPU.
- Processor Speed: Lists the CPU processing speed
- Actual Ratio: Lists the ratio of the frequency to the clock speed
- Processor Stepping: Lists the CPU processing stepping
- Microcode Revision: Lists the microcode revision
- L1 Cache RAM: Lists the CPU L1 cache size
- L2 Cache RAM: Lists the CPU L2 cache size
- Processor Cores: Lists the number of the processor core
- Hyper-Threading: Indicates if the Intel HT Technology is supported by the CPU.

ECW-281B/B2-D525 Embedded System

→ Hyper Threading [Enabled]

Use the Hyper Threading function to enable or disable the CPU hyper threading function.

- **Disabled** Disables the use of hyper threading technology
- **Enabled DEFAULT** Enables the use of hyper threading technology

5.3.3 IDE Configuration

Use the **IDE Configuration** menu (**BIOS Menu 5**) to change and/or set the configuration of the IDE devices installed in the system.

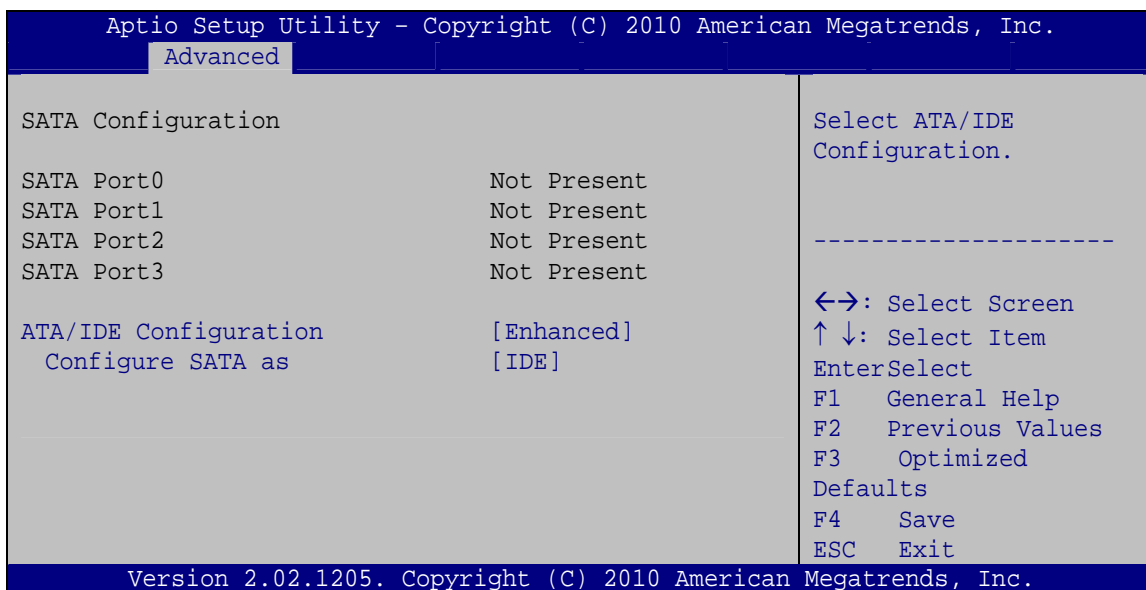

BIOS Menu 5: IDE Configuration

→ ATA/IDE Configurations [Enhanced]

Use the **ATA/IDE Configurations** option to configure the ATA/IDE controller.

- **Disabled** Disables the on-board ATA/IDE controller.
- **Compatible** Configures the on-board ATA/IDE controller to be in compatible mode. In this mode, a SATA channel will replace one of the IDE channels. This mode supports up to 4 storage devices.

- ➔ **Enhanced** **DEFAULT** Configures the on-board ATA/IDE controller to be in Enhanced mode. In this mode, IDE channels and SATA channels are separated. This mode supports up to 6 storage devices. Some legacy OS do not support this mode.

➔ **Configure SATA as [IDE]**

Use the **Configure SATA as** option to configure SATA devices as normal IDE devices.

- ➔ **IDE** **DEFAULT** Configures SATA devices as normal IDE device.
- ➔ **AHCI** Configures SATA devices as normal AHCI device.

5.3.4 USB Configuration

Use the **USB Configuration** menu (**BIOS Menu 6**) to read USB configuration information and configure the USB settings.

```

Aptio Setup Utility - Copyright (C) 2010 American Megatrends, Inc.
  Advanced
-----
USB Configuration
USB Devices:
  1 Keyboard, 2 Hubs
Legacy USB Support                      [Enabled]
-----
Enables Legacy USB support. AUTO option disables legacy support if no USB devices are connected. DISABLE option will keep USB devices available only for EFI applications.

-----
<=>: Select Screen
↑↓: Select Item
Enter>Select
F1    General Help
F2    Previous Values
F3    Optimized Defaults
F4    Save
ESC   Exit

Version 2.02.1205. Copyright (C) 2010 American Megatrends, Inc.
  
```

BIOS Menu 6: USB Configuration

ECW-281B/B2-D525 Embedded System

→ USB Devices

The **USB Devices Enabled** field lists the USB devices that are enabled on the system

→ Legacy USB Support [Enabled]

Use the **Legacy USB Support** BIOS option to enable USB mouse and USB keyboard support. Normally if this option is not enabled, any attached USB mouse or USB keyboard does not become available until a USB compatible operating system is fully booted with all USB drivers loaded. When this option is enabled, any attached USB mouse or USB keyboard can control the system even when there is no USB driver loaded onto the system.

- **Enabled** **DEFAULT** Legacy USB support enabled
- **Disabled** Legacy USB support disabled
- **Auto** Legacy USB support disabled if no USB devices are connected

5.3.5 Super IO Configuration

Use the **Super IO Configuration** menu (**BIOS Menu 7**) to set or change the configurations for the FDD controllers, parallel ports and serial ports.

```

Aptio Setup Utility - Copyright (C) 2010 American Megatrends, Inc.
  Advanced
-----
Super IO Configuration
Super IO Chip                      Fintek F81865
> Serial Port 1 Configuration
> Serial Port 3 Configuration
> Serial Port 4 Configuration
> Serial Port 5 Configuration
> Serial Port 6 Configuration
> Serial Port 2 Configuration
Set Parameters of Serial
Port 0 (COMA)
-----
<->: Select Screen
↑ ↓: Select Item
Enter>Select
F1    General Help
F2    Previous Values
F3    Optimized
      Defaults
F4    Save
ESC   Exit
Version 2.02.1205. Copyright (C) 2010 American Megatrends, Inc.
  
```

BIOS Menu 7: Super IO Configuration

5.3.5.1 Serial Port n Configuration

Use the **Serial Port n Configuration** menu (**BIOS Menu 8**) to configure the serial port n.

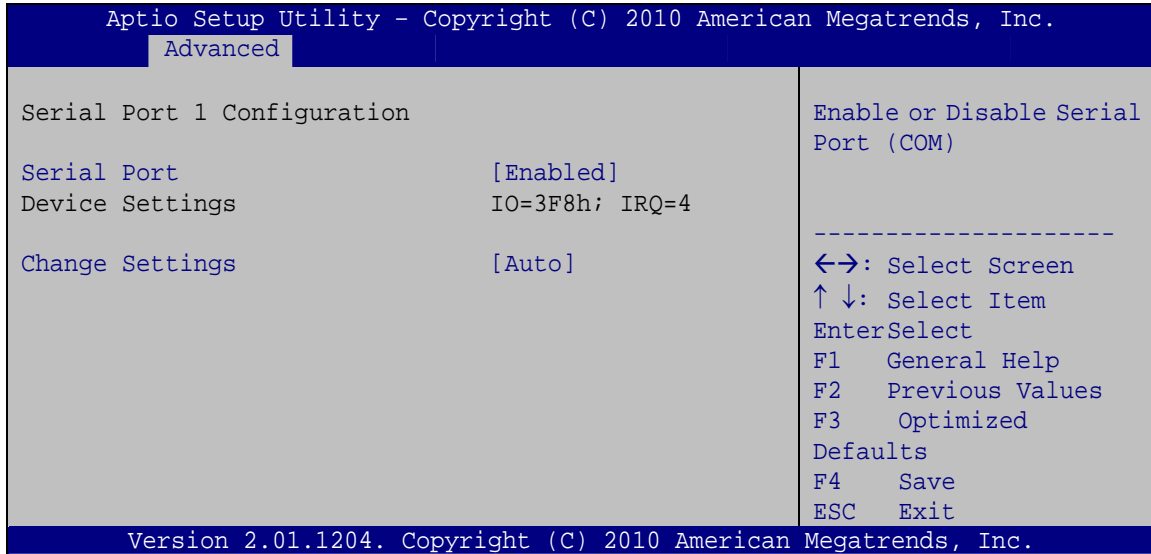

BIOS Menu 8: Serial Port n Configuration Menu

5.3.5.1.1 Serial Port 1 Configuration

→ Serial Port [Enabled]

Use the **Serial Port** option to enable or disable the serial port.

- **Disabled** Disable the serial port
- **Enabled** **DEFAULT** Enable the serial port

→ Change Settings [Auto]

Use the **Change Settings** option to change the serial port IO port address and interrupt address.

- **Auto** **DEFAULT** The serial port IO port address and interrupt address are automatically detected.
- **IO=3F8h;**
IRQ=4 Serial Port I/O port address is 3F8h and the interrupt address is IRQ4

ECW-281B/B2-D525 Embedded System

- ➔ **IO=3F8h;** Serial Port I/O port address is 3E8h and the interrupt
IRQ=3, 4 address is IRQ3, 4
- ➔ **IO=2F8h;** Serial Port I/O port address is 2F8h and the interrupt
IRQ=3, 4 address is IRQ3, 4

5.3.5.1.2 Serial Port 3 Configuration

➔ Serial Port [Enabled]

Use the **Serial Port** option to enable or disable the serial port.

- ➔ **Disabled** Disable the serial port
- ➔ **Enabled** **DEFAULT** Enable the serial port

➔ Change Settings [Auto]

Use the **Change Settings** option to change the serial port IO port address and interrupt address.

- ➔ **Auto** **DEFAULT** The serial port IO port address and interrupt address
are automatically detected.
- ➔ **IO=2F8h;** Serial Port I/O port address is 2F8h and the interrupt
IRQ=3 address is IRQ3
- ➔ **IO=3F8h;** Serial Port I/O port address is 3F8h and the interrupt
IRQ=3, 4 address is IRQ3, 4
- ➔ **IO=2F8h;** Serial Port I/O port address is 2F8h and the interrupt
IRQ=3, 4 address is IRQ3, 4

5.3.5.1.3 Serial Port 4 Configuration

➔ Serial Port [Enabled]

Use the **Serial Port** option to enable or disable the serial port.

- ➔ **Disabled** Disable the serial port

→ **Enabled** **DEFAULT** Enable the serial port

→ **Change Settings [Auto]**

Use the **Change Settings** option to change the serial port IO port address and interrupt address.

→ **Auto** **DEFAULT** The serial port IO port address and interrupt address are automatically detected.

→ **IO=3E8h;**
IRQ=11 Serial Port I/O port address is 3E8h and the interrupt address is IRQ11

→ **IO=3E8h;**
IRQ=10, 11 Serial Port I/O port address is 3E8h and the interrupt address is IRQ10, 11

→ **IO=2E8h;**
IRQ=10, 11 Serial Port I/O port address is 2E8h and the interrupt address is IRQ10, 11

5.3.5.1.4 Serial Port 5 Configuration

→ **Serial Port [Enabled]**

Use the **Serial Port** option to enable or disable the serial port.

→ **Disabled** Disable the serial port

→ **Enabled** **DEFAULT** Enable the serial port

→ **Change Settings [Auto]**

Use the **Change Settings** option to change the serial port IO port address and interrupt address.

→ **Auto** **DEFAULT** The serial port IO port address and interrupt address are automatically detected.

ECW-281B/B2-D525 Embedded System

- ➔ **IO=2E8h;**
IRQ=10 Serial Port I/O port address is 2E8h and the interrupt address is IRQ10
- ➔ **IO=3E8h;**
IRQ=10, 11 Serial Port I/O port address is 3E8h and the interrupt address is IRQ10, 11
- ➔ **IO=2E8h;**
IRQ=10, 11 Serial Port I/O port address is 2E8h and the interrupt address is IRQ10, 11

5.3.5.1.5 Serial Port 6 Configuration

➔ Serial Port [Enabled]

Use the **Serial Port** option to enable or disable the serial port.

- ➔ **Disabled** Disable the serial port
- ➔ **Enabled DEFAULT** Enable the serial port

➔ Change Settings [Auto]

Use the **Change Settings** option to change the serial port IO port address and interrupt address.

- ➔ **Auto DEFAULT** The serial port IO port address and interrupt address are automatically detected.
- ➔ **IO=2C0h;**
IRQ=11 Serial Port I/O port address is 2C0h and the interrupt address is IRQ11
- ➔ **IO=2C0h;**
IRQ=10, 11 Serial Port I/O port address is 2C0h and the interrupt address is IRQ10, 11
- ➔ **IO=2C8h;**
IRQ=10, 11 Serial Port I/O port address is 2C8h and the interrupt address is IRQ10, 11

5.3.5.1.6 Serial Port 2 Configuration

➔ **Serial Port [Enabled]**

Use the **Serial Port** option to enable or disable the serial port.

- ➔ **Disabled** Disable the serial port
- ➔ **Enabled DEFAULT** Enable the serial port

➔ **Change Settings [Auto]**

Use the **Change Settings** option to change the serial port IO port address and interrupt address.

- ➔ **Auto DEFAULT** The serial port IO port address and interrupt address are automatically detected.
- ➔ **IO=2C8h;
IRQ=10** Serial Port I/O port address is 2C8h and the interrupt address is IRQ10
- ➔ **IO=2C0h;
IRQ=10, 11** Serial Port I/O port address is 2C0h and the interrupt address is IRQ10, 11
- ➔ **IO=2C8h;
IRQ=10, 11** Serial Port I/O port address is 2C8h and the interrupt address is IRQ10, 11

ECW-281B/B2-D525 Embedded System

5.3.6 H/W Monitor

The H/W Monitor menu (**BIOS Menu 9**) shows the operating temperature, fan speeds and system voltages.

```

Aptio Setup Utility - Copyright (C) 2010 American Megatrends, Inc.
-----
Advanced
-----
PC Health Status

CPU Temperature           :+53 C
Accuracy:1.(-5~+10)degree around 100 degree
                2.(-10~+15)degree around 50 degree
SYS Temperature          :+37 C
CPU FAN Speed            :N/A
SYS FAN Speed            :N/A
VCC3C                    :+3.312 V
V_core                   :+1.160 V
V1_05V                   :+1.040 V
VCC3V                    :+3.288 V
Vcc                      :+5.003 V
VSB3V                    :+3.328 V
VBAT                     :+3.216 V
CPU Smart Fan control    [Auto Mode]
Temperature Bound 1      60
Temperature Bound 2      50
Temperature Bound 3      40
Temperature Bound 4      30
SYS Smart Fan control    [Auto Mode]
Temperature Bound 1      60
Temperature Bound 2      50
Temperature Bound 3      40
Temperature Bound 4      30

-----
<->: Select Screen
↑ ↓: Select Item
Enter>Select
F1   General Help
F2   Previous Values
F3   Optimized
Defaults
F4   Save
ESC  Exit
    
```

BIOS Menu 9: Hardware Health Configuration

➔ PC Health Status

The following system parameters and values are shown. The system parameters that are monitored are:

- System Temperatures:
 - CPU Temperature
 - System Temperature
- Fan Speeds:

- CPU Fan Speed
- System Fan Speed
- Voltages:
 - VCC3V
 - V_core
 - V1_05V
 - VCC3V
 - Vcc
 - VSB3V
 - VBAT

→ CPU Smart Fan control [Auto Mode]

Use the **CPU Smart Fan control** option to configure the CPU fan.

→ Auto Mode

The fan adjusts its speed using these settings:

Temperature Bound 1

Temperature Bound 2

Temperature Bound 3

Temperature Bound 4

→ Manual Mode

The fan spins at the speed set in:

Manual Duty Cycle Setting

5.3.7 Serial Port Console Redirection

The **Serial Port Console Redirection** menu (**BIOS Menu 10**) allows the console redirection options to be configured. Console redirection allows users to maintain a system remotely by re-directing keyboard input and text output through the serial port.

ECW-281B/B2-D525 Embedded System

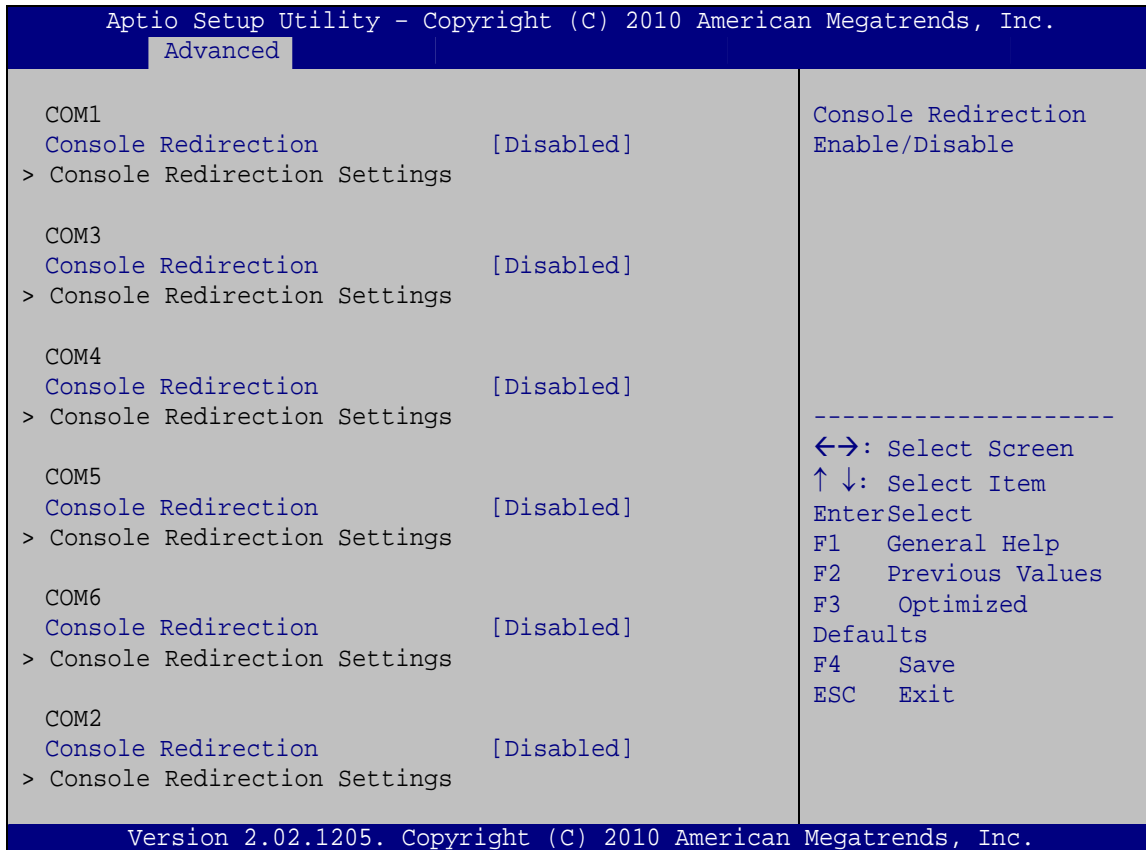

BIOS Menu 10: Serial Port Console Redirection

→ Console Redirection [Disabled]

Use **Console Redirection** option to enable or disable the console redirection function.

- **Disabled** **DEFAULT** Disabled the console redirection function
- **Enabled** Enabled the console redirection function

→ Terminal Type [ANSI]

Use the **Terminal Type** option to specify the remote terminal type.

- **VT100** The target terminal type is VT100
- **VT100+** The target terminal type is VT100+
- **ANSI** **DEFAULT** The target terminal type is ANSI

➔ **Bits per second [115200]**

Use the **Bits per second** option to specify the bits per second.

- 9600
- 19200
- 57600
- 115200 **DEFAULT**

5.3.8 IEI Feature

Use the **IEI Feature** menu (**BIOS Menu 11**) to configure One Key Recovery function.

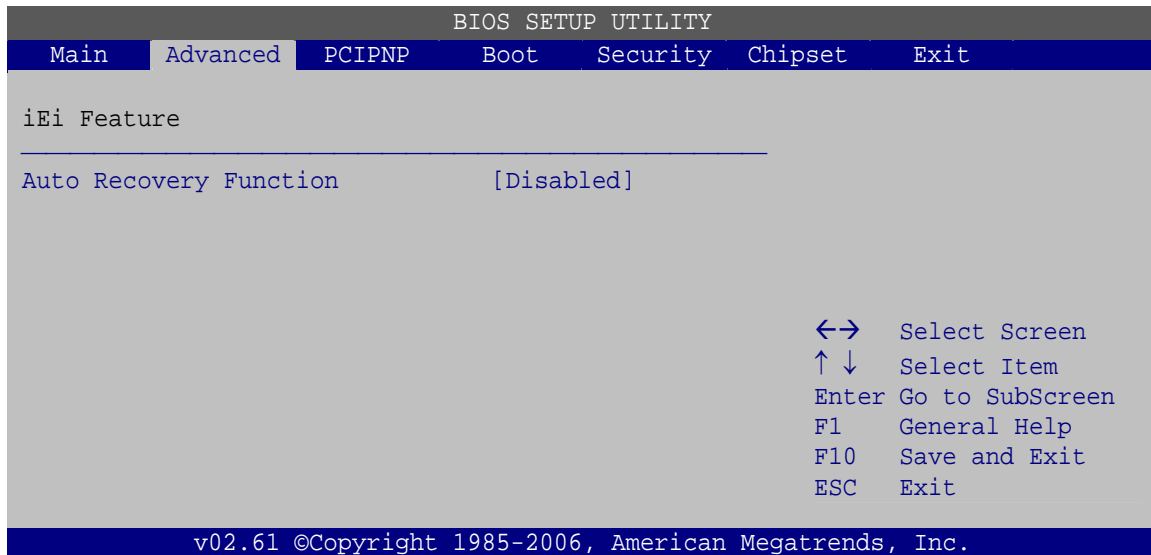

BIOS Menu 11: IEI Feature

➔ **Auto Recovery Function [Disabled]**

Use the **Auto Recovery Function** BIOS option to enable or disable the auto recovery function of the IEI One Key Recovery.

- ➔ **Disabled DEFAULT Auto recovery function disabled**
- ➔ **Enabled Auto recovery function enabled**

ECW-281B/B2-D525 Embedded System

5.4 Chipset

Use the **Chipset** menu (**BIOS Menu 12**) to access the Northbridge and Southbridge configuration menus



WARNING!

Setting the wrong values for the Chipset BIOS selections in the Chipset BIOS menu may cause the system to malfunction.

```

Aptio Setup Utility - Copyright (C) 2010 American Megatrends, Inc.
Main   Advanced  Chipset  Boot   Security  Save & Exit
-----
> Host Bridge                Host Bridge Parameters
> South Bridge
> Intel IGD SWSCI OpRegion

-----
<=>: Select Screen
↑↓: Select Item
Enter>Select
F1   General Help
F2   Previous Values
F3   Optimized
Defaults
F4   Save
ESC  Exit

Version 2.02.1205. Copyright (C) 2010 American Megatrends, Inc.

```

BIOS Menu 12: Chipset

5.4.1 Host Bridge

Use the **Host Bridge** menu (**BIOS Menu 13**) to configure the host bridge chipset.

```

Aptio Setup Utility - Copyright (C) 2010 American Megatrends, Inc.
  Chipset
-----
> OnChip VGA Configuration
  Initiate Graphic Adapter      [IGD]
                                Config On Chip VGA
                                Settings

***** Memory Information *****
Memory Frequency                800 Mhz

Total Memory                    2048 MB

DIMM#0                          2048 MB
DIMM#1                          Not present

-----
<=>: Select Screen
↑↓: Select Item
Enter>Select
F1   General Help
F2   Previous Values
F3   Optimized
Defaults
F4   Save
ESC  Exit

Version 2.02.1205. Copyright (C) 2010 American Megatrends, Inc.

```

BIOS Menu 13:Host Bridge Configuration

→ Initiate Graphic Adapter

Use the **Initiate Graphic Adapter** option to select the graphics controller used as the primary boot device. Select either an integrated graphics controller (IGD) or a combination of PCI graphics controller, a PCI express (PEG) controller or an IGD. Configuration options are listed below:

- IGD
- PCI/IGD **DEFAULT**

ECW-281B/B2-D525 Embedded System

5.4.1.1 OnChip VGA Configuration

Use the **OnChip VGA Configuration** menu (**BIOS Menu 13**) to configure the OnChip VGA.

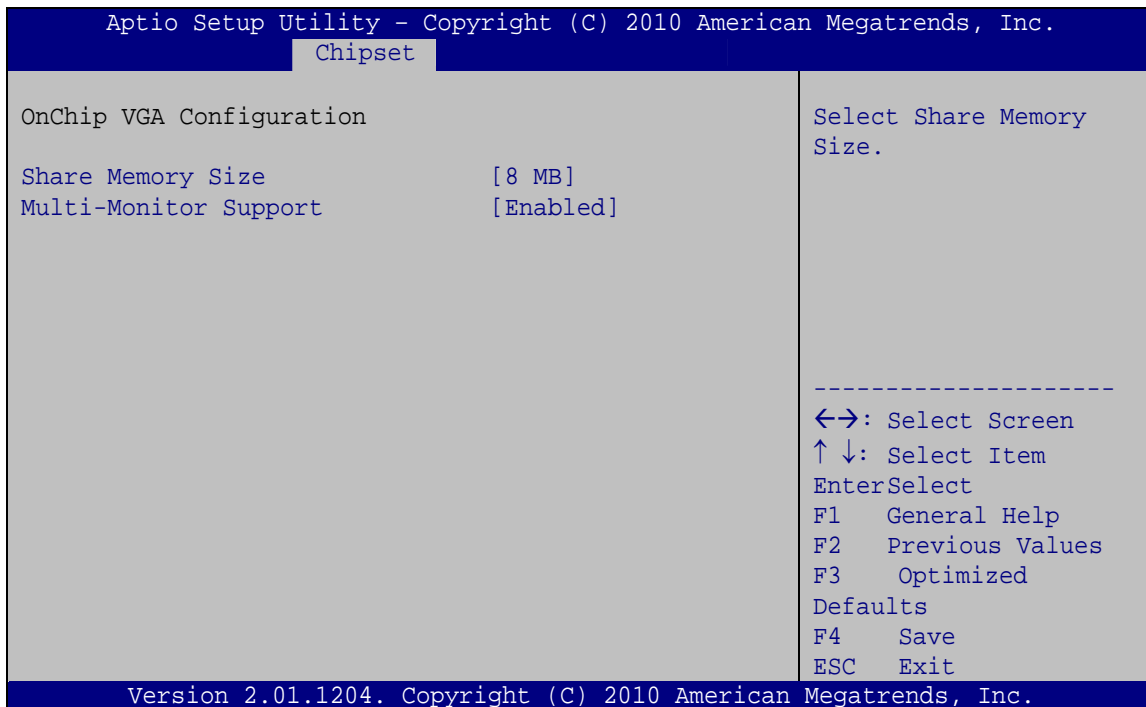

BIOS Menu 14: OnChip VGA Configuration

→ Share Memory Size [8 MB]

Use the **Share Memory Size** option to set the amount of system memory allocated to the integrated graphics processor when the system boots. The system memory allocated can then only be used as graphics memory, and is no longer available to applications or the operating system. Configuration options are listed below:

- Disabled
- 1 MB
- 8 MB **Default**

→ Multi-Monitor Support [Enabled]

Use **Multi-Monitor Support** option to enable or disable the multi-monitor function.

- ➔ **Disabled** Disabled the multi-monitor function
- ➔ **Enabled** **DEFAULT** Enabled the multi-monitor function

5.4.2 South Bridge

Use the **South Bridge** menu (**BIOS Menu 15**) to configure the Southbridge chipset.

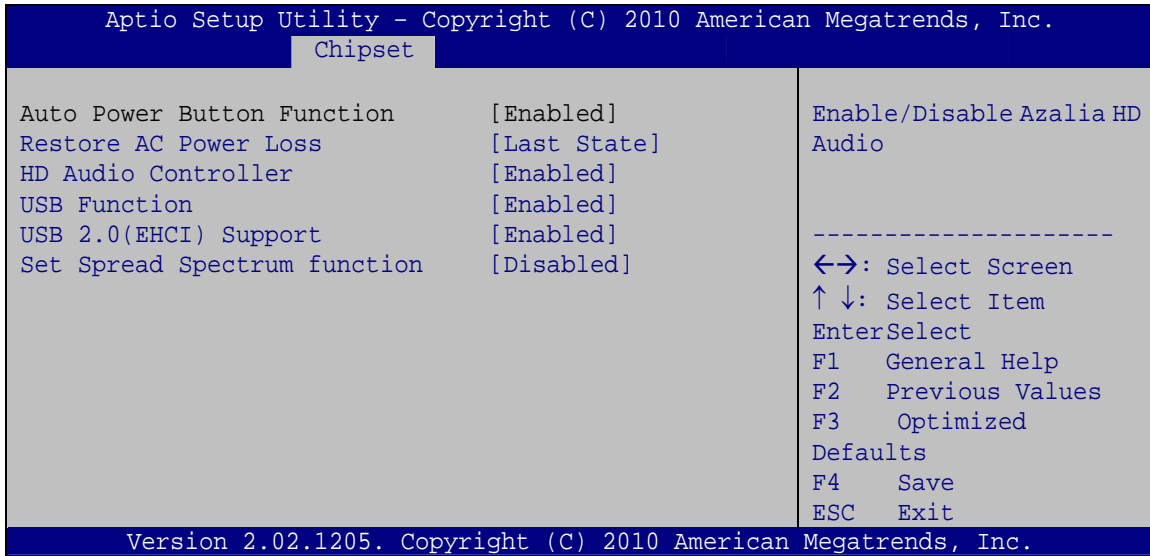

BIOS Menu 15:Southbridge Chipset Configuration

➔ Restore on AC Power Loss [Last State]

Use the **Restore on AC Power Loss** BIOS option to specify what state the system returns to if there is a sudden loss of power to the system.

- ➔ **Power Off** The system remains turned off
- ➔ **Power On** The system turns on
- ➔ **Last State** **DEFAULT** The system returns to its previous state. If it was on, it turns itself on. If it was off, it remains off.

➔ HD Audio Controller [Enabled]

The **HD Audio Controller** option enables or disables the HD audio controller.

ECW-281B/B2-D525 Embedded System

→ **Enabled** **DEFAULT** The onboard HD audio controller automatically detected and enabled

→ **Disabled** The onboard HD audio controller is disabled

→ **USB Function [Enabled]**

Use the **USB Function** BIOS option to enable or disable USB function support.

→ **Disabled** USB function support disabled

→ **Enabled** **DEFAULT** USB function support enabled

→ **USB 2.0 (EHCI) Support [Enabled]**

Use the **USB 2.0 (EHCI) Support** BIOS option to enable or disable the USB 2.0 controller.

→ **Enabled** **DEFAULT** USB 2.0 controller enabled

→ **Disabled** USB 2.0 controller disabled

→ **Set Spread Spectrum Function [Disabled]**

The **Set Spread Spectrum Function** option can help to improve CPU EMI issues.

→ **Disabled** **DEFAULT** The spread spectrum function is disabled

→ **Enabled** The spread spectrum function is enabled

5.4.3 Intel IGD SWSCI OpRegion

Use the **Intel IGD SWSCI OpRegion** menu to configure the video device connected to the system.

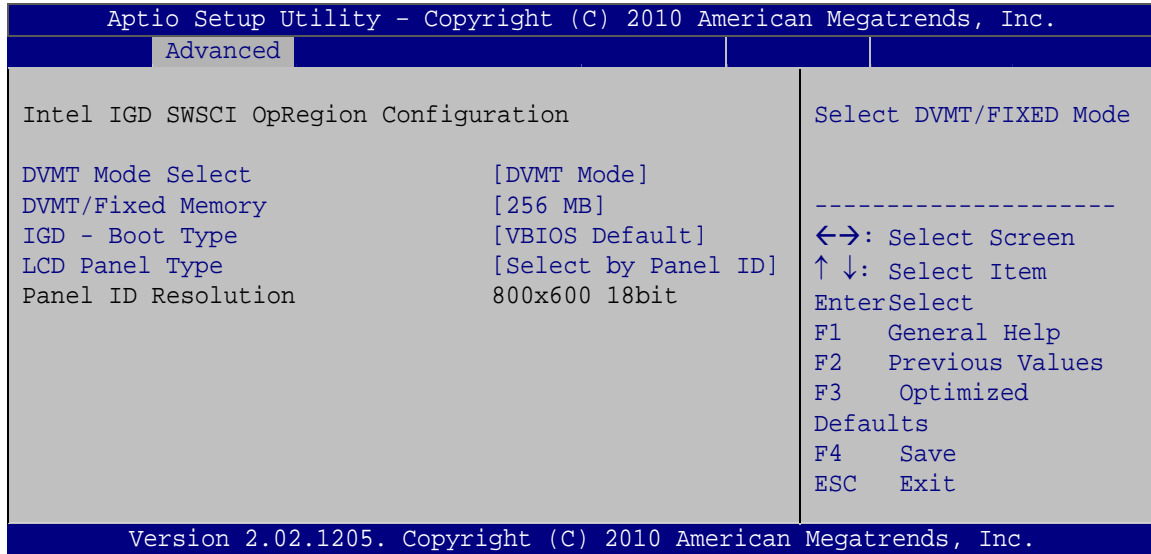

BIOS Menu 16: Intel IGD SWSCI OpRegion

→ DVMT Mode Select [DVMT Mode]

Use the **DVMT Mode Select** option to select the Intel Dynamic Video Memory Technology (DVMT) operating mode.

- **Fixed Mode** A fixed portion of graphics memory is reserved as graphics memory.
- **DVMT Mode DEFAULT** Graphics memory is dynamically allocated according to the system and graphics needs.

→ DVMT/FIXED Memory [256 MB]

Use the **DVMT/FIXED Memory** option to specify the maximum amount of memory that can be allocated as graphics memory. Configuration options are listed below.

- 128 MB
- 256 MB **Default**
- Maximum

→ IGD - Boot Type [VBIOS Default]

Use the **IGD - Boot Type** option to select the display device used by the system when it boots. Configuration options are listed below.

ECW-281B/B2-D525 Embedded System

- VBIOS Default **DEFAULT**
- CRT
- LFP
- CRT + LFP

→ LCD Panel Type [VBIOS Default]

Use the **LCD Panel Type** option to select the type of flat panel connected to the system. Configuration options are listed below.

- Select by Panel ID **DEFAULT**
- 640x480 18bit
- 800x480 18bit
- 800x600 18bit
- 1024x768 18bit
- 1280x1024 18bit
- 1366x768 18bit
- 1280x800 18bit
- 1280x600 18bit

5.5 Boot

Use the **Boot** menu (**BIOS Menu 17**) to configure system boot options.

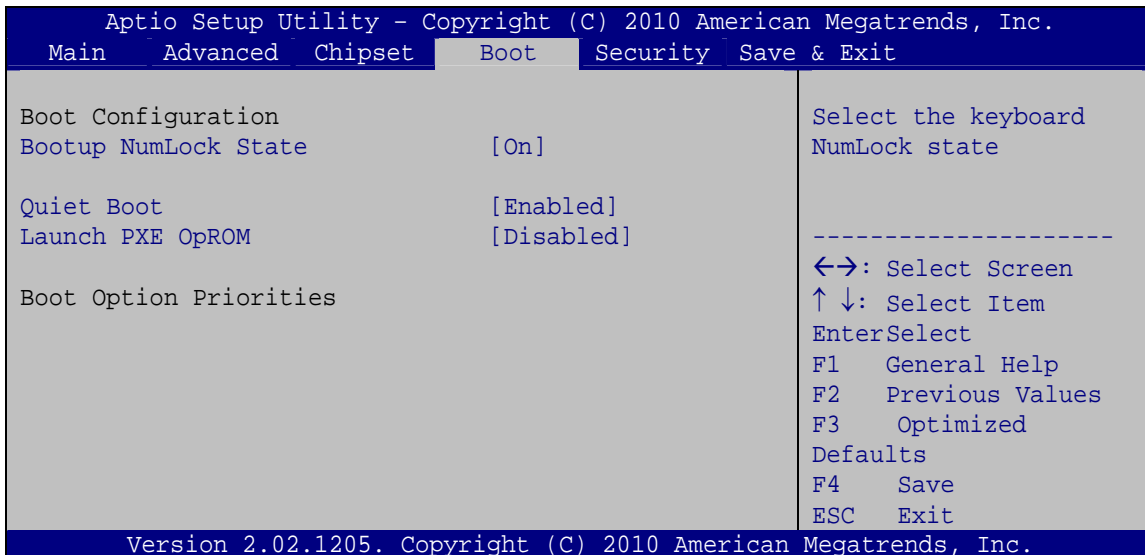

BIOS Menu 17: Boot

→ **Bootup NumLock State [On]**

Use the **Bootup NumLock State** BIOS option to specify if the number lock setting must be modified during boot up.

- **On** **DEFAULT** Allows the Number Lock on the keyboard to be enabled automatically when the computer system boots up. This allows the immediate use of the 10-key numeric keypad located on the right side of the keyboard. To confirm this, the Number Lock LED light on the keyboard is lit.

- **Off** Does not enable the keyboard Number Lock automatically. To use the 10-keys on the keyboard, press the Number Lock key located on the upper left-hand corner of the 10-key pad. The Number Lock LED on the keyboard lights up when the Number Lock is engaged.

→ **Quiet Boot [Enabled]**

Use the **Quiet Boot** BIOS option to select the screen display when the system boots.

- **Disabled** Normal POST messages displayed

- **Enabled** **DEFAULT** OEM Logo displayed instead of POST messages

→ **Launch PXE OpROM [Disabled]**

Use the **Launch PXE OpROM** option to enable or disable boot option for legacy network devices.

- **Disabled** **DEFAULT** Ignore all PXE Option ROMs

- **Enabled** Load PXE Option ROMs.

ECW-281B/B2-D525 Embedded System

5.6 Security

Use the **Security** menu (**BIOS Menu 18**) to set system and user passwords.

```

Aptio Setup Utility - Copyright (C) 2010 American Megatrends, Inc.
Main   Advanced  Chipset  Boot   Security  Save & Exit
-----
Password Description
If ONLY the Administrator's password is set,
then this only limits access to Setup and is
only asked for when entering Setup
If ONLY the User's password is set, then this
is a power on password and must be entered to
boot or enter Setup. In Setup the User will
have Administrator rights.

Administrator Password
User Password

Set User Password
Set Master Password

Set Setup Administrator
Password

-----
<-->: Select Screen
↑ ↓: Select Item
Enter>Select
F1   General Help
F2   Previous Values
F3   Optimized
Defaults
F4   Save
ESC  Exit

Version 2.02.1205. Copyright (C) 2010 American Megatrends, Inc.

```

BIOS Menu 18: Security

→ Administrator Password

Use the **Administrator Password** to set or change a administrator password.

→ User Password

Use the **User Password** to set or change a user password.

5.7 Exit

Use the **Exit** menu (**BIOS Menu 19**) to load default BIOS values, optimal failsafe values and to save configuration changes.

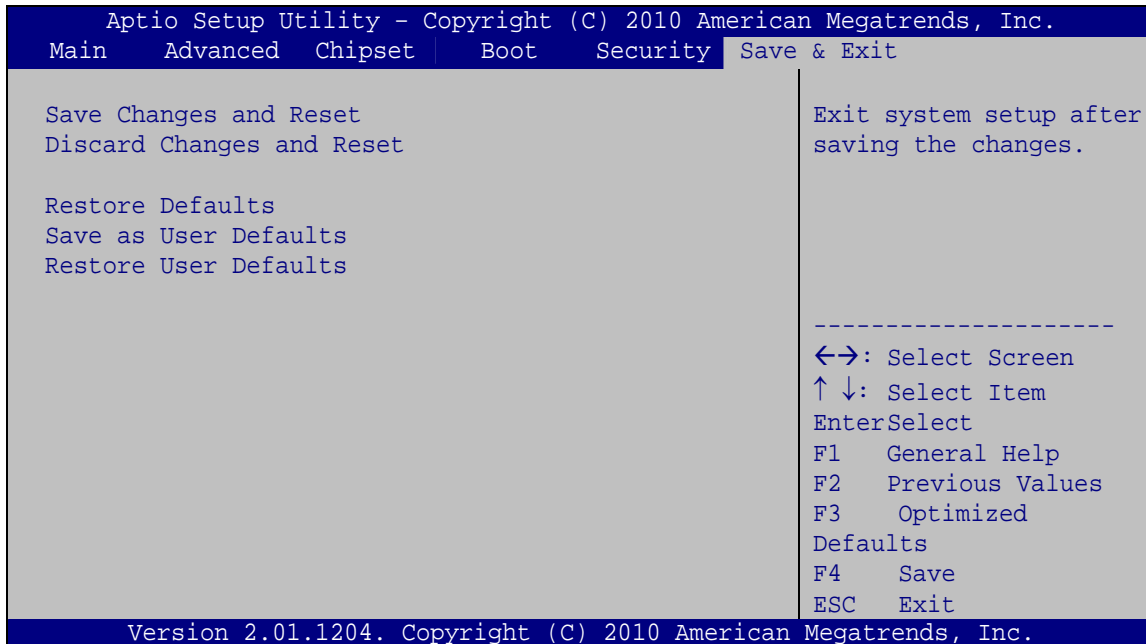
BIOS Menu 19:Exit
→ Save Changes and Reset

Use the **Save Changes and Reset** option to save the changes made to the BIOS options and to exit the BIOS configuration setup program.

→ Discard Changes and Reset

Use the **Discard Changes and Reset** option to exit the system without saving the changes made to the BIOS configuration setup program.

→ Restore Defaults

Use the **Restore Defaults** option to load the optimal default values for each of the parameters on the Setup menus. **F3 key can be used for this operation.**

→ Save as User Defaults

Use the **Save as User Defaults** option to save the changes done so far as user defaults.

→ Restore User Defaults

Use the **Restore User Defaults** option to restore the user defaults to all the setup options.

Chapter

6

Troubleshooting and Maintenance

**WARNING:**

Take Anti-Static precautions whenever maintenance is being carried out on the system components. Failure to take anti-static precautions can cause permanent system damage. For more details on anti-static precautions, please refer to **Section 4.1**.

6.1 ECW-281B/B2-D525 System Maintenance Overview

**NOTE:**

When doing maintenance operations on the system, please follow the instructions in this chapter. Failure to follow these instructions may lead to personal injury and system damage.

To preserve the working integrity of the ECW-281B/B2-D525 embedded system, the system must be properly maintained. If embedded system components need replacement, the proper maintenance procedures must be followed to ensure the system can continue to operate normally.

6.2 System Troubleshooting

This section provides some simple troubleshooting suggestions.

6.2.1 The System Doesn't Turn On

If after turning the system on, there is no power (indicated by the power button on the front panel not turning on) please do the following:

- Step 1:** Check that the power cable connector is properly connected to the terminal block or power socket on the system front panel.
- Step 2:** Check that the power cable connector is properly plugged into the power source.
- Step 3:** Make sure the power button is turned on.

ECW-281B/B2-D525 Embedded System

Step 4: Plug the system into a monitor and check to see if anything appears on the screen. If the boot-up screen appears it means the power LED has become disconnected. To fix this problem, open the top cover and reconnect the power LED to the motherboard.

If the above steps have been completed and the system still doesn't turn on, please do the following.

Step 1: Open the bottom surface (**Section 4.2.3**)

Step 2: Check the terminal block/power socket power cable connector is properly connected to the power module or motherboard.

Step 3: Check that the power button cable connector is properly connected to the motherboard.

Step 4: Make sure the cable connecting to the terminal block/power socket are properly attached and have not become separated.

Step 5: Make sure the cable connecting the power button to the motherboard is still properly attached to the power button and has not been separated.

6.2.2 The System Doesn't Boot Up

If the system doesn't boot up please do the following:

Step 1: Check the power is turned on. See **Section 6.2.1** above.

Step 2: Make sure the SO-DIMM module is properly installed.

Step 3: Reset the system using the reset CMOS jumper.

6.2.3 More Troubleshooting

- ***Nothing appears on the monitor after booting up the system:*** Make sure the monitor is properly connected to the system and the monitor is connected to a power supply and turned on.



WARNING!

If all troubleshooting measures have been taken and the system still fails to start, contact the IEI reseller or vendor you purchased the ECW-281B/B2-D525 from or contact an IEI sales representative directly. To contact an IEI sales representative, please send an email to sales@iei.com.tw.

6.3 Component Replacement Procedure



WARNING!

Users are not advised to attempt to repair or replace any internal or external components of the ECW-281B/B2-D525 embedded system other than those listed below. If any other components fail or need replacement, contact the IEI reseller or vendor you purchased the ECW-281B/B2-D525 from or contact an IEI sales representative directly. To contact an IEI sales representative, please send an email to sales@iei.com.tw.

The embedded system components listed below can all be replaced if they fail:

- SO-DIMM module
- Internal hard disk drive (see **Section 4.2.5**)

ECW-281B/B2-D525 Embedded System

6.3.1 SO-DIMM Replacement



WARNING:

Using incorrectly specified SO-DIMM may cause permanently damage the ECW-281B/B2-D525. Please make sure the purchased SO-DIMM complies with the memory specifications of the ECW-281B/B2-D525.

To replace a SO-DIMM memory module into a SO-DIMM socket, please follow the steps below.

Step 1: Remove the bottom surface panel. Place the ECW-281B/B2-D525 on an anti-static pad with the bottom panel facing up and the bottom surface removed. (see Section 4.2.3).

Step 2: Locate the SO-DIMM on the motherboard.

Step 3: Remove the SO-DIMM by releasing the arms on the SO-DIMM socket.

Step 4: Align the new SO-DIMM with the socket. The SO-DIMM must be oriented in such a way that the notch in the middle of the SO-DIMM must be aligned with the plastic bridge in the socket (Figure 6-1).

Step 5: Insert the SO-DIMM. Push the SO-DIMM chip into the socket at an angle (Figure 6-1).

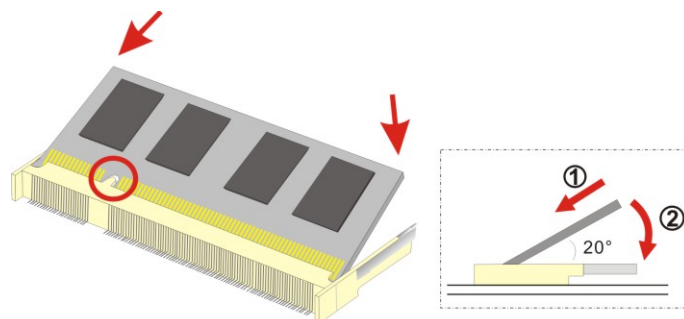

Figure 6-1: SO-DIMM Installation

ECW-281B/B2-D525 Embedded System

- Step 6:** **Open the SO-DIMM socket arms.** Gently pull the arms of the SO-DIMM socket out and push the rear of the SO-DIMM down. (See **Figure 6-1**)
- Step 7:** **Secure the SO-DIMM.** Release the arms on the SO-DIMM socket. They clip into place and secure the SO-DIMM in the socket.

Appendix

A

Safety Precautions

**WARNING:**

The precautions outlined in this chapter should be strictly followed. Failure to follow these precautions may result in permanent damage to the ECW-281B/B2-D525.

A.1 Safety Precautions

Please follow the safety precautions outlined in the sections that follow:

A.1.1 General Safety Precautions

Please ensure the following safety precautions are adhered to at all times.

- **Follow the electrostatic precautions** outlined below whenever the ECW-281B/B2-D525 is opened.
- **Make sure the power is turned off and the power cord is disconnected** whenever the ECW-281B/B2-D525 is being installed, moved or modified.
- **Do not apply voltage levels that exceed the specified voltage range.** Doing so may cause fire and/or an electrical shock.
- **Electric shocks can occur** if the ECW-281B/B2-D525 chassis is opened when the ECW-281B/B2-D525 is running.
- **Do not drop or insert any objects** into the ventilation openings of the ECW-281B/B2-D525.
- **If considerable amounts of dust, water, or fluids enter the ECW-281B/B2-D525**, turn off the power supply immediately, unplug the power cord, and contact the ECW-281B/B2-D525 vendor.
- **DO NOT:**
 - Drop the ECW-281B/B2-D525 against a hard surface.
 - In a site where the ambient temperature exceeds the rated temperature

ECW-281B/B2-D525 Embedded System

A.1.2 Anti-static Precautions



WARNING:

Failure to take ESD precautions during the installation of the ECW-281B/B2-D525 may result in permanent damage to the ECW-281B/B2-D525 and severe injury to the user.

Electrostatic discharge (ESD) can cause serious damage to electronic components, including the ECW-281B/B2-D525. Dry climates are especially susceptible to ESD. It is therefore critical that whenever the ECW-281B/B2-D525 is opened and any of the electrical components are handled, the following anti-static precautions are strictly adhered to.

- ***Wear an anti-static wristband:*** Wearing a simple anti-static wristband can help to prevent ESD from damaging any electrical component.
- ***Self-grounding:*** Before handling any electrical component, touch any grounded conducting material. During the time the electrical component is handled, frequently touch any conducting materials that are connected to the ground.
- ***Use an anti-static pad:*** When configuring or working with an electrical component, place it on an anti-static pad. This reduces the possibility of ESD damage.
- ***Only handle the edges of the electrical component:*** When handling the electrical component, hold the electrical component by its edges.

A.1.3 Product Disposal

**CAUTION:**

Risk of explosion if battery is replaced by and incorrect type. Only certified engineers should replace the on-board battery.

Dispose of used batteries according to instructions and local regulations.

- Outside the European Union - If you wish to dispose of used electrical and electronic products outside the European Union, please contact your local authority so as to comply with the correct disposal method.
- Within the European Union:

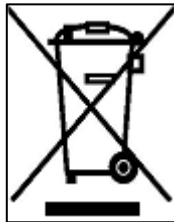

EU-wide legislation, as implemented in each Member State, requires that waste electrical and electronic products carrying the mark (left) must be disposed of separately from normal household waste. This includes monitors and electrical accessories, such as signal cables or power cords.

When you need to dispose of your display products, please follow the guidance of your local authority, or ask the shop where you purchased the product. The mark on electrical and electronic products only applies to the current European Union Member States.

Please follow the national guidelines for electrical and electronic product disposal.

A.2 Maintenance and Cleaning Precautions

When maintaining or cleaning the ECW-281B/B2-D525, please follow the guidelines below.

A.2.1 Maintenance and Cleaning

Prior to cleaning any part or component of the ECW-281B/B2-D525, please read the details below.

ECW-281B/B2-D525 Embedded System

- The interior of the ECW-281B/B2-D525 does not require cleaning. Keep fluids away from the ECW-281B/B2-D525 interior.
- Be cautious of all small removable components when vacuuming the ECW-281B/B2-D525.
- Turn the ECW-281B/B2-D525 off before cleaning the ECW-281B/B2-D525.
- Never drop any objects or liquids through the openings of the ECW-281B/B2-D525.
- Be cautious of any possible allergic reactions to solvents or chemicals used when cleaning the ECW-281B/B2-D525.
- Avoid eating, drinking and smoking within vicinity of the ECW-281B/B2-D525.

A.2.2 Cleaning Tools

Some components in the ECW-281B/B2-D525 may only be cleaned using a product specifically designed for the purpose. In such case, the product will be explicitly mentioned in the cleaning tips. Below is a list of items to use when cleaning the ECW-281B/B2-D525.

- **Cloth** – Although paper towels or tissues can be used, a soft, clean piece of cloth is recommended when cleaning the ECW-281B/B2-D525.
- **Water or rubbing alcohol** – A cloth moistened with water or rubbing alcohol can be used to clean the ECW-281B/B2-D525.
- **Using solvents** – The use of solvents is not recommended when cleaning the ECW-281B/B2-D525 as they may damage the plastic parts.
- **Vacuum cleaner** – Using a vacuum specifically designed for computers is one of the best methods of cleaning the ECW-281B/B2-D525. Dust and dirt can restrict the airflow in the ECW-281B/B2-D525 and cause its circuitry to corrode.
- **Cotton swabs** - Cotton swabs moistened with rubbing alcohol or water are excellent tools for wiping hard to reach areas.
- **Foam swabs** - Whenever possible, it is best to use lint free swabs such as foam swabs for cleaning.

Appendix

B

One Key Recovery

B.1 One Key Recovery Introduction

The IEI one key recovery is an easy-to-use front end for the Norton Ghost system backup and recovery tool. The one key recovery provides quick and easy shortcuts for creating a backup and reverting to that backup or for reverting to the factory default settings.

The IEI One Key Recovery tool menu is shown below.

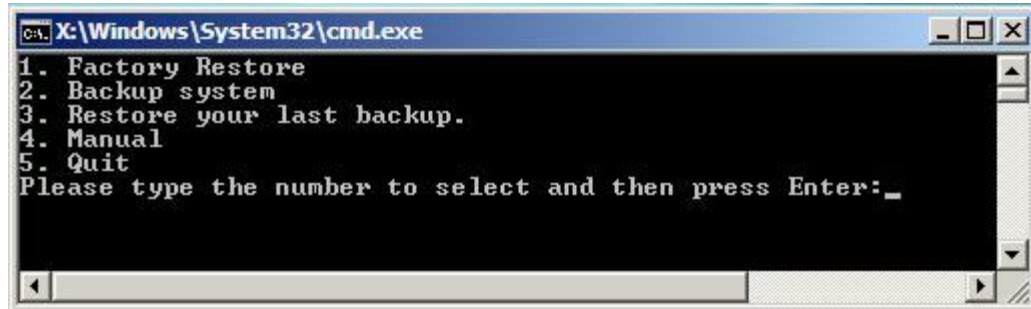

Figure B-1: IEI One Key Recovery Tool Menu

Prior to using the IEI One Key Recovery tool (as shown in **Figure B-1**) to backup or restore Windows system, five setup procedures are required.

1. Hardware and BIOS setup (see **Section B.2.1**)
2. Create partitions (see **Section B.2.2**)
3. Install operating system, drivers and system applications (see **Section B.2.3**)
4. Build-up recovery partition (see **Section B.2.4**)
5. Create factory default image (see **Section B.2.5**)

After completing the five initial setup procedures as described above, users can access the recovery tool by pressing <F3> while booting up the system. The detailed information of each function is described in **Section B.4**.



NOTE:

The initial setup procedures for Linux system are described in **Section B.3**.

B.1.1 System Requirement



NOTE:

The recovery CD can only be used with IEI products. The software will fail to run and a warning message will appear when used on non-IEI hardware.

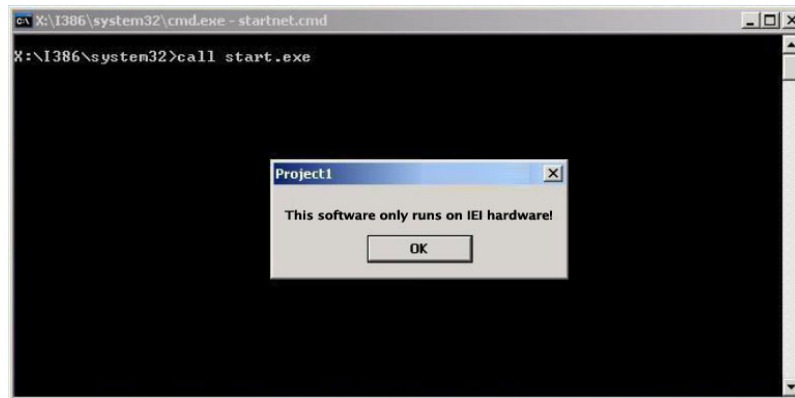

To create the system backup, the main storage device must be split into two partitions (three partitions for Linux). The first partition will be for the operating system, while the second partition will be invisible to the operating system and contain the backup made by the one key recovery software.

The partition created for recovery images must be big enough to contain both the factory default image and the user backup image. The size must be calculated before creating the partitions. Please take the following table as a reference when calculating the size of the partition.

	OS	OS Image after Ghost	Compression Ratio
Windows® 7	7 GB	5 GB	70%
Windows® XPE	776 MB	560 MB	70%
Windows® CE 6.0	36 MB	28 MB	77%

**NOTE:**

Specialized tools are required to change the partition size if the operating system is already installed.

B.1.2 Supported Operating System

The recovery CD is compatible with both Microsoft Windows and Linux operating system (OS). The supported OS versions are listed below.

- Microsoft Windows
 - Windows XP (Service Pack 2 or 3 required)
 - Windows Vista
 - Windows 7
 - Windows CE 5.0
 - Windows CE 6.0
 - Windows XP Embedded
- Linux
 - Fedora Core 12 (Constantine)
 - Fedora Core 11 (Leonidas)
 - Fedora Core 10 (Cambridge)
 - Fedora Core 8 (Werewolf)
 - Fedora Core 7 (Moonshine)
 - RedHat RHEL-5.4
 - RedHat 9 (Ghirke)
 - Ubuntu 8.10 (Intrepid)
 - Ubuntu 7.10 (Gutsy)
 - Ubuntu 6.10 (Edgy)
 - Debian 5.0 (Lenny)
 - Debian 4.0 (Etch)
 - SuSe 11.2
 - SuSe 10.3

**NOTE:**

Installing unsupported OS versions may cause the recovery tool to fail.

B.2 Setup Procedure for Windows

Prior to using the recovery tool to backup or restore Windows system, a few setup procedures are required.

Step 1: Hardware and BIOS setup (see **Section B.2.1**)

Step 2: Create partitions (see **Section B.2.2**)

Step 3: Install operating system, drivers and system applications (see **Section B.2.3**)

Step 4: Build-up recovery partition (see **Section B.2.4**)

Step 5: Create factory default image (see **Section B.2.5**)

The detailed descriptions are described in the following sections.

**NOTE:**

The setup procedures described below are for Microsoft Windows operating system users. For Linux system, most setup procedures are the same with Microsoft Windows except for several steps which is described in **Section B.3**.

B.2.1 Hardware and BIOS Setup

Step 1: Make sure the system is powered off and unplugged.

Step 2: Install a hard drive or SSD in the system. An unformatted and unpartitioned disk is recommended.

Step 3: Connect an optical disk drive to the system and insert the recovery CD.

- Step 4:** Turn on the system.
- Step 5:** Press the <DELETE> key as soon as the system is turned on to enter the BIOS.
- Step 6:** Select the connected optical disk drive as the 1st boot device. (**Boot** → **Boot Device Priority** → **1st Boot Device**).
- Step 7:** Save changes and restart the computer. Continue to the next section for instructions on partitioning the internal storage.

B.2.2 Create Partitions

To create the system backup, the main storage device must be split into two partitions (three partitions for Linux). The first partition will be for the operating system, while the second partition will be invisible to the operating system and contain the backup made by the one key recovery software.

- Step 1:** Put the recovery CD in the optical drive of the system.
- Step 2:** **Boot the system from recovery CD.** When prompted, press any key to boot from the recovery CD. It will take a while to launch the recovery tool. Please be patient!

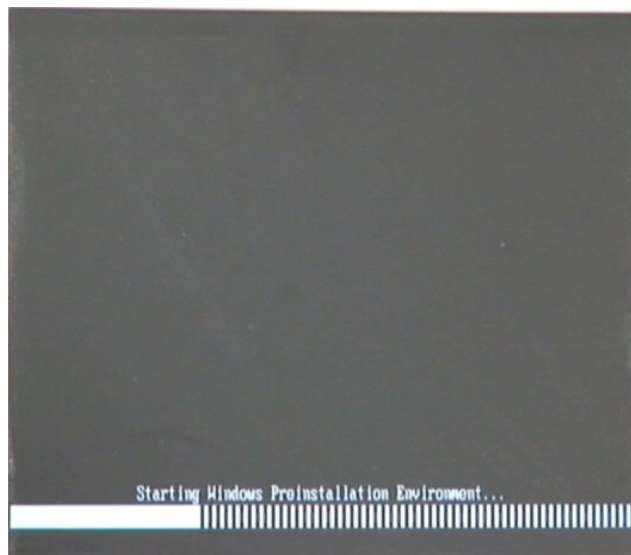
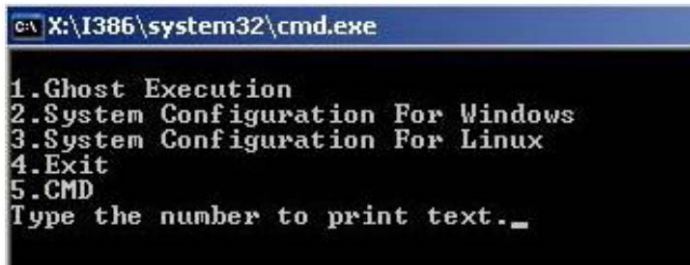

Figure B-2: Launching the Recovery Tool

ECW-281B/B2-D525 Embedded System

Step 3: The recovery tool setup menu is shown as below.



```
C:\X:\I386\system32\cmd.exe
1.Ghost Execution
2.System Configuration For Windows
3.System Configuration For Linux
4.Exit
5.CMD
Type the number to print text._
```

Figure B-3: Recovery Tool Setup Menu

Step 4: Press <5> then <Enter>.

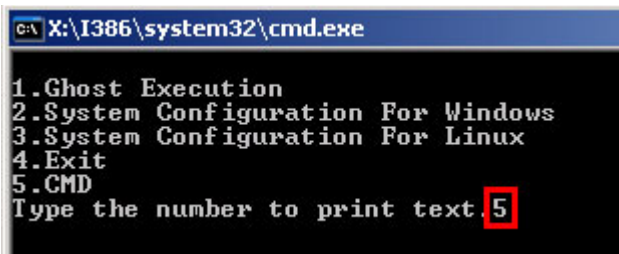

```
C:\X:\I386\system32\cmd.exe
1.Ghost Execution
2.System Configuration For Windows
3.System Configuration For Linux
4.Exit
5.CMD
Type the number to print text. 5
```

Figure B-4: Command Mode

Step 5: The command prompt window appears. Type the following commands (marked in red) to create two partitions. One is for the OS installation; the other is for saving recovery files and images which will be an invisible partition.

(Press <Enter> after entering each line below)

```
system32>diskpart
DISKPART>list vol
DISKPART>sel disk 0
DISKPART>create part pri size= ____
DISKPART>assign letter=N
DISKPART>create part pri size= ____
DISKPART>assign letter=F
DISKPART>exit
system32>format N: /fs:ntfs /q /y
```

system32>format F: /fs:ntfs /q /v:Recovery /y

system32>exit

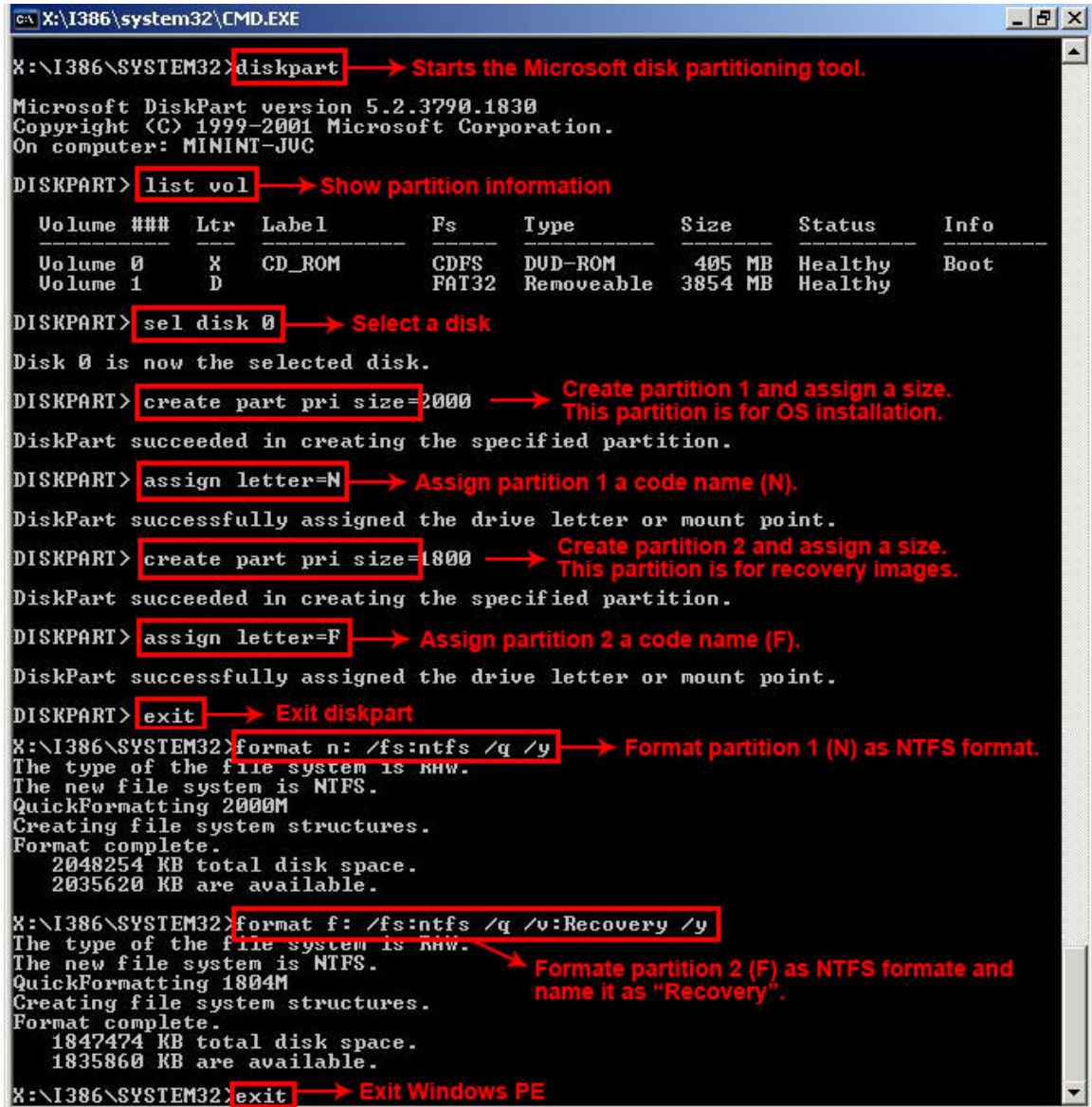

```

X:\I386\SYSTEM32\CMD.EXE
X:\I386\SYSTEM32>diskpart → Starts the Microsoft disk partitioning tool.
Microsoft DiskPart version 5.2.3790.1830
Copyright (C) 1999-2001 Microsoft Corporation.
On computer: MININT-JUC
DISKPART> list vol → Show partition information
   Volume ###  Ltr  Label          Fs          Type          Size         Status       Info
   -----  -  -  -  -  -  -  -  -  -
   Volume 0             X  CD_ROM         GDFS        DUD-ROM       405 MB       Healthy      Boot
   Volume 1             D                FAT32        Removeable   3854 MB       Healthy
DISKPART> sel disk 0 → Select a disk
Disk 0 is now the selected disk.
DISKPART> create part pri size=2000 → Create partition 1 and assign a size.
                                     This partition is for OS installation.
DiskPart succeeded in creating the specified partition.
DISKPART> assign letter=N → Assign partition 1 a code name (N).
DiskPart successfully assigned the drive letter or mount point.
DISKPART> create part pri size=1800 → Create partition 2 and assign a size.
                                     This partition is for recovery images.
DiskPart succeeded in creating the specified partition.
DISKPART> assign letter=F → Assign partition 2 a code name (F).
DiskPart successfully assigned the drive letter or mount point.
DISKPART> exit → Exit diskpart
X:\I386\SYSTEM32>format n: /fs:ntfs /q /y → Format partition 1 (N) as NTFS format.
The type of the file system is ntfs.
The new file system is NTFS.
QuickFormatting 2000M
Creating file system structures.
Format complete.
2048254 KB total disk space.
2035620 KB are available.
X:\I386\SYSTEM32>format f: /fs:ntfs /q /v:Recovery /y → Formate partition 2 (F) as NTFS formate and
                                                         name it as "Recovery".
The type of the file system is ntfs.
The new file system is NTFS.
QuickFormatting 1804M
Creating file system structures.
Format complete.
1847474 KB total disk space.
1835860 KB are available.
X:\I386\SYSTEM32>exit → Exit Windows PE
  
```

Figure B-5: Partition Creation Commands



NOTE:

Use the following commands to check if the partitions were created successfully.

```

X:\I386\SYSTEM32>diskpart
Microsoft DiskPart version 5.2.3790.1830
Copyright (C) 1999-2001 Microsoft Corporation.
On computer: MININT-JUC
DISKPART> sel disk 0
Disk 0 is now the selected disk.
DISKPART> list part
  Partition ###  Type              Size      Offset
-----
  Partition 1    Primary           2000 MB    32 KB
  Partition 2    Primary           1804 MB    2000 MB
DISKPART> exit
    
```

Step 6: Press any key to exit the recovery tool and automatically reboot the system.

Please continue to the following procedure: Build-up Recovery Partition.

B.2.3 Install Operating System, Drivers and Applications

Install the operating system onto the unlabelled partition. The partition labeled as "Recovery" is for use by the system recovery tool and should not be used for installing the operating system or any applications.



NOTE:

The operating system installation program may offer to reformat the chosen partition. DO NOT format the partition again. The partition has already been formatted and is ready for installing the new operating system.

To install the operating system, insert the operating system installation CD into the optical drive. Restart the computer and follow the installation instructions.

B.2.4 Build-up Recovery Partition

Step 1: Put the recover CD in the optical drive.

Step 2: Start the system.

Step 3: **Boot the system from recovery CD.** When prompted, press any key to boot from the recovery CD. It will take a while to launch the recovery tool. Please be patient!

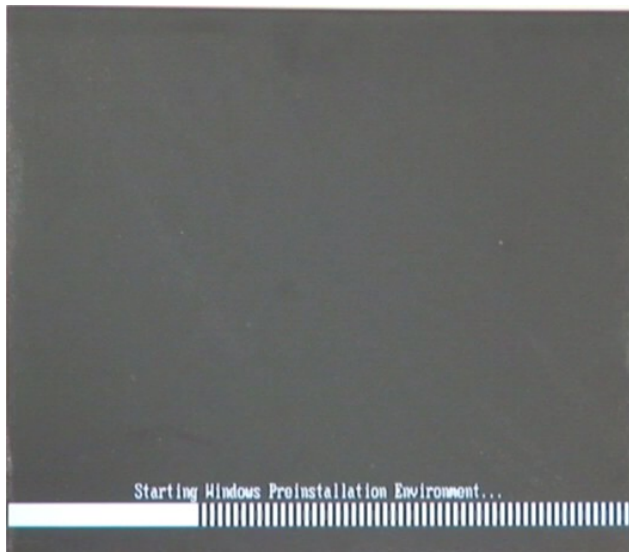

Figure B-6: Launching the Recovery Tool

Step 4: When the recovery tool setup menu appears, press <2> then <Enter>.

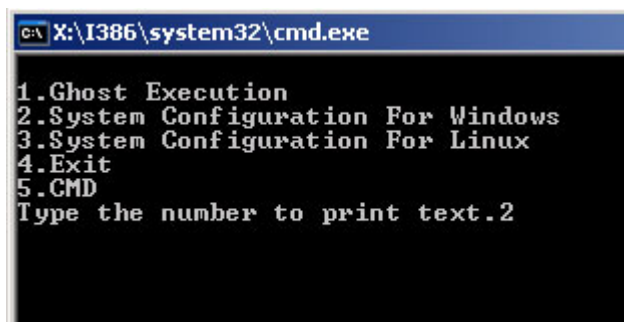

Figure B-7: System Configuration for Windows

Step 5: The Symantec Ghost window appears and starts configuring the system to build-up a recovery partition. In this process, the partition which is created for

ECW-281B/B2-D525 Embedded System

recovery files in **Section B.2.2** is hidden and the recovery tool is saved in this partition.

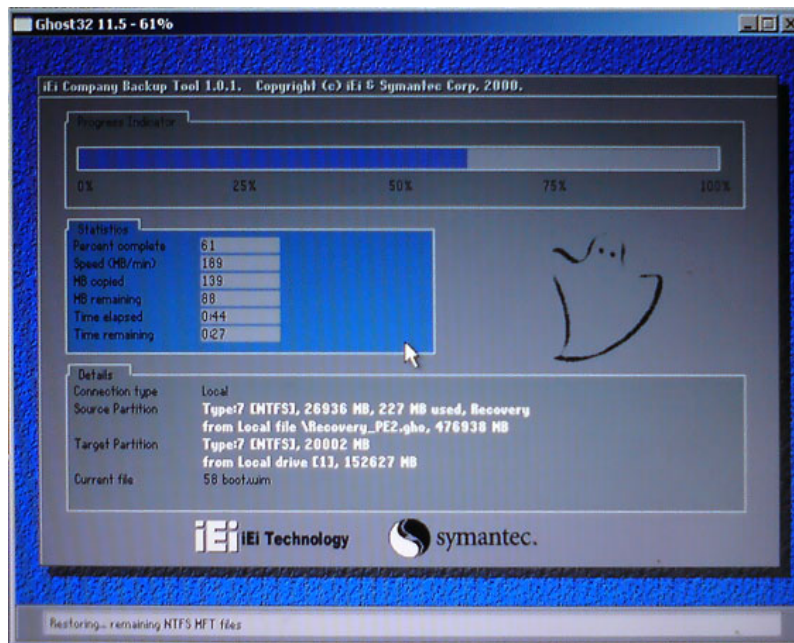

Figure B-8: Build-up Recovery Partition

Step 6: After completing the system configuration, press any key in the following window to reboot the system.

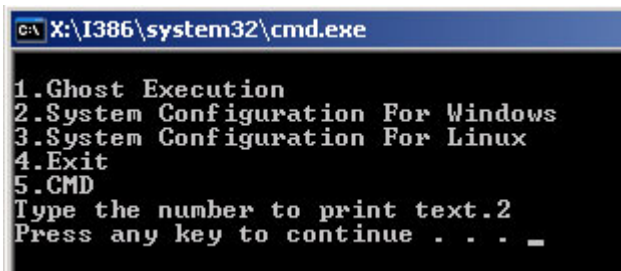

Figure B-9: Press any key to continue

Step 7: Eject the recovery CD.

B.2.5 Create Factory Default Image



NOTE:

Before creating the factory default image, please configure the system to a factory default environment, including driver and application installations.

To create a factory default image, please follow the steps below.

Step 1: Turn on the system. When the following screen displays (**Figure B-10**), press the <F3> key to access the recovery tool. The message will display for 10 seconds, please press F3 before the system boots into the operating system.

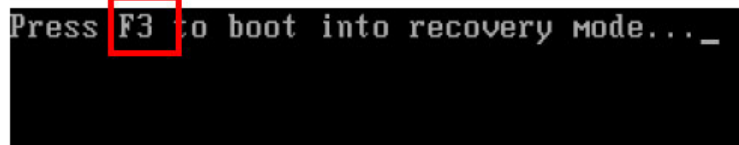

Figure B-10: Press F3 to Boot into Recovery Mode

Step 2: The recovery tool menu appears. Type <4> and press <Enter>. (**Figure B-11**)

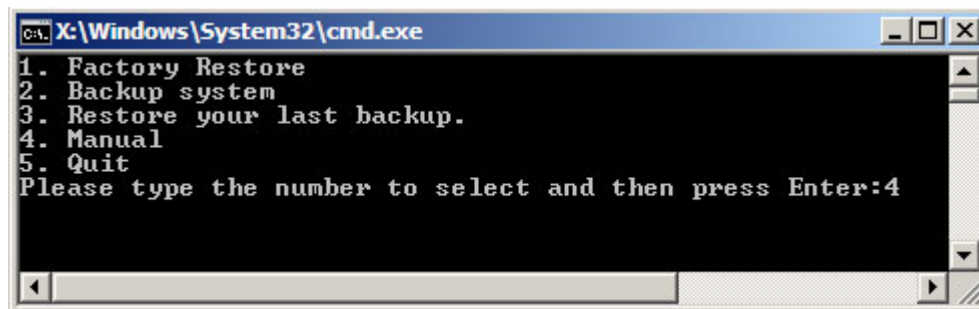

Figure B-11: Recovery Tool Menu

Step 3: The About Symantec Ghost window appears. Click **OK** button to continue.

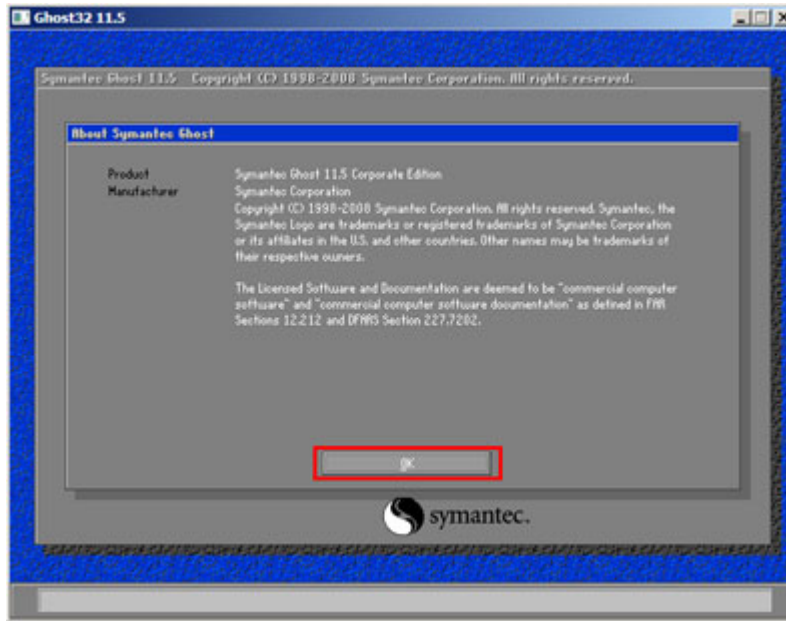

Figure B-12: About Symantec Ghost Window

Step 4: Use mouse to navigate to the option shown below (Figure B-13).

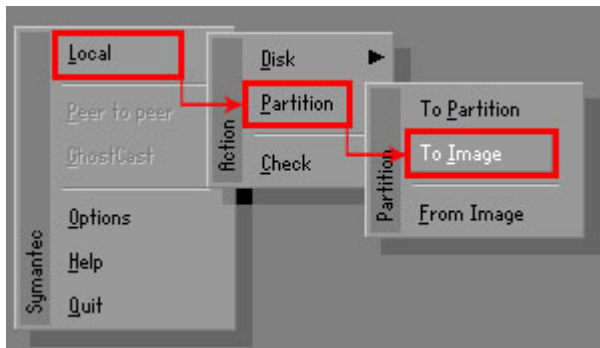
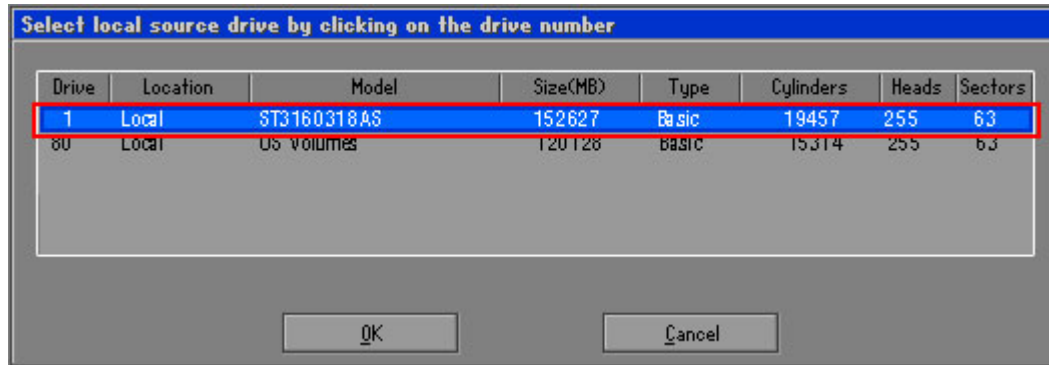
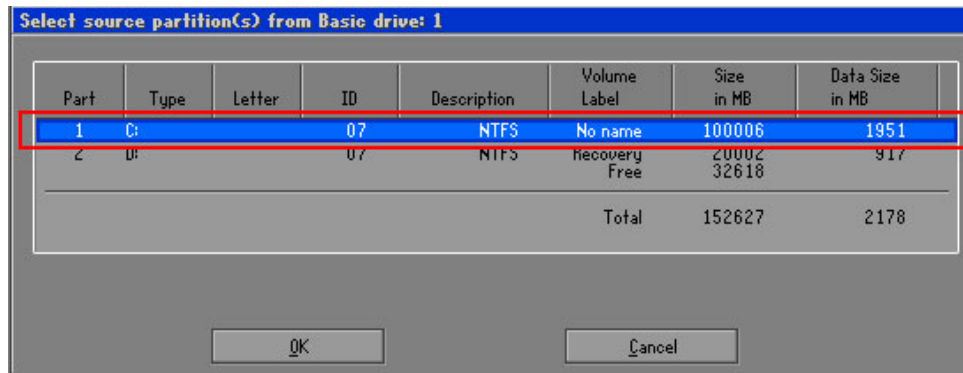

Figure B-13: Symantec Ghost Path

Step 5: Select the local source drive (Drive 1) as shown in Figure B-14. Then click OK.

Figure B-14: Select a Local Source Drive

Step 6: Select a source partition (Part 1) from basic drive as shown in **Figure B-15**. Then click OK.

Figure B-15: Select a Source Partition from Basic Drive

Step 7: Select **1.2: [Recovery] NTFS drive** and enter a file name called **iei** (**Figure B-16**). Click **Save**. The factory default image will then be saved in the selected recovery drive and named **IEI.GHO**.

WARNING:

The file name of the factory default image must be **iei.GHO**.

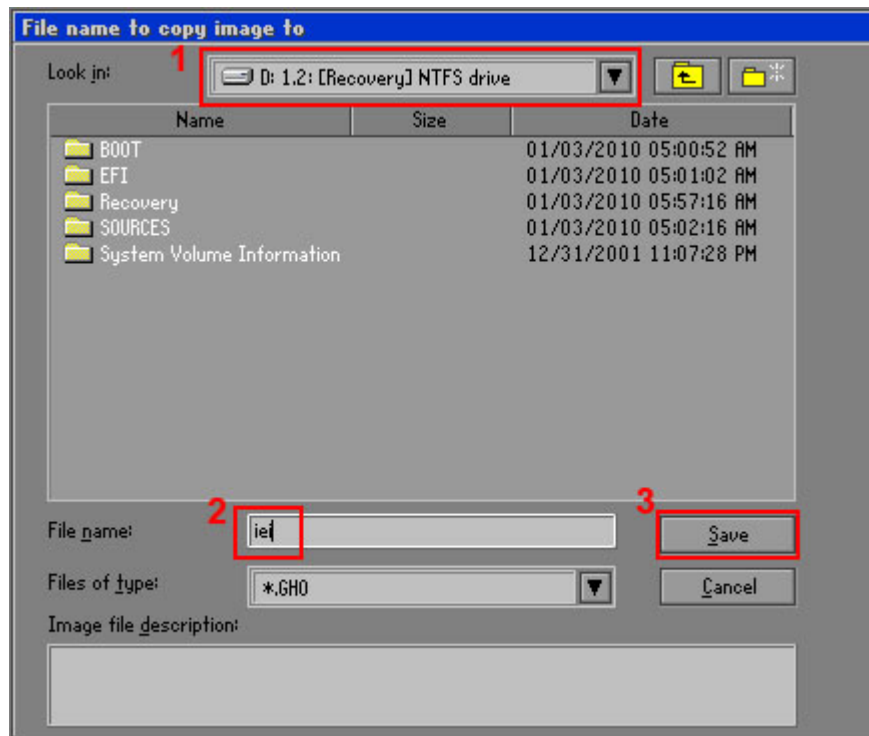

Figure B-16: File Name to Copy Image to

Step 8: When the Compress Image screen in **Figure B-17** prompts, click **High** to make the image file smaller.

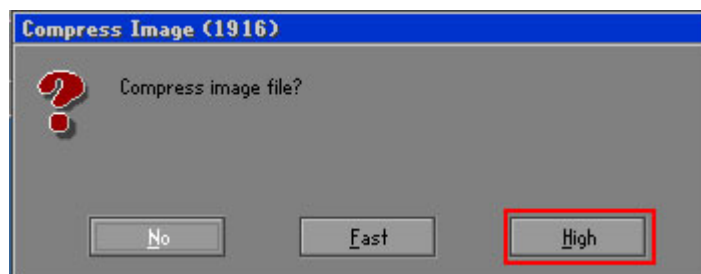

Figure B-17: Compress Image

Step 9: The Proceed with partition image creation window appears, click **Yes** to continue.

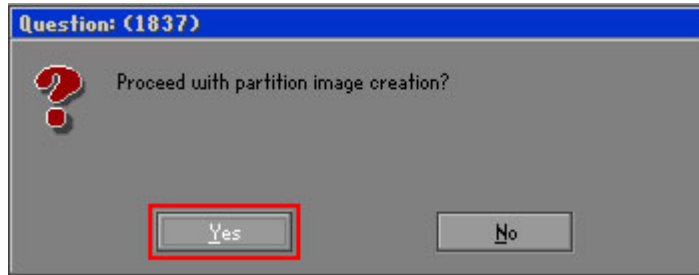

Figure B-18: Image Creation Confirmation

Step 10: The Symantec Ghost starts to create the factory default image (**Figure B-19**).

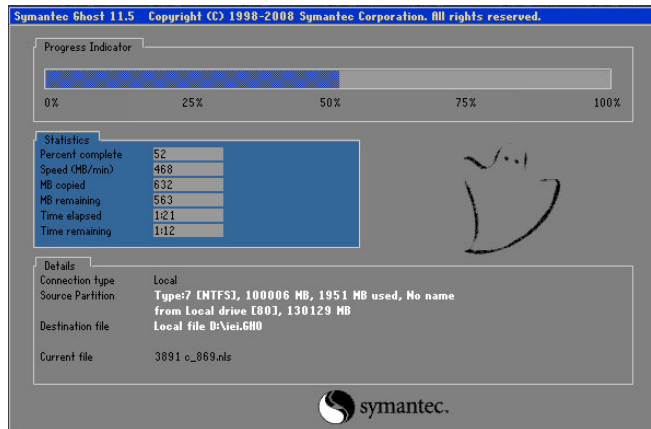

Figure B-19: Image Creation Process

Step 11: When the image creation completes, a screen prompts as shown in **Figure B-20**. Click **Continue** and close the Ghost window to exit the program.

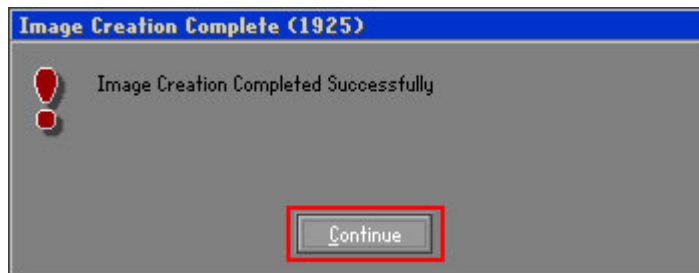
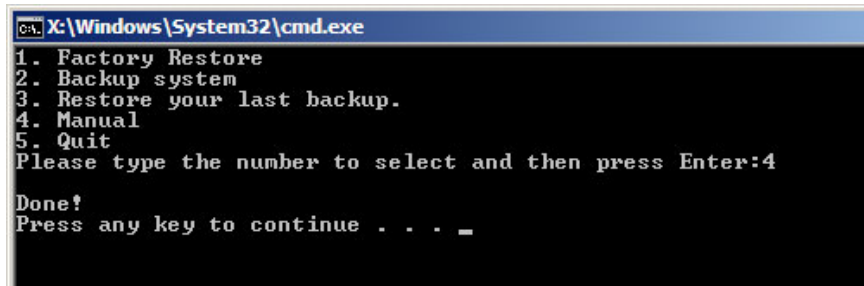

Figure B-20: Image Creation Complete

ECW-281B/B2-D525 Embedded System

Step 12: The recovery tool main menu window is shown as below. Press any key to reboot the system.



```
C:\Windows\System32\cmd.exe
1. Factory Restore
2. Backup system
3. Restore your last backup.
4. Manual
5. Quit
Please type the number to select and then press Enter:4
Done!
Press any key to continue . . . _
```

Figure B-21: Press Any Key to Continue

B.3 Setup Procedure for Linux

The initial setup procedures for Linux system are mostly the same with the procedure for Microsoft Windows. Please follow the steps below to setup recovery tool for Linux OS.

Step 1: **Hardware and BIOS setup.** Refer to **Section B.2.1.**

Step 2: **Install Linux operating system.** Make sure to install GRUB (v0.97 or earlier) MBR type and Ext3 partition type. Leave enough space on the hard drive to create the recover partition later.



NOTE:

If the Linux OS is not installed with GRUB (v0.97 or earlier) and Ext3, the Symantec Ghost may not function properly.

While installing Linux OS, please create two partitions:

- Partition 1: /
- Partition 2: **SWAP**

NOTE:

Please reserve enough space for partition 3 for saving recovery images.

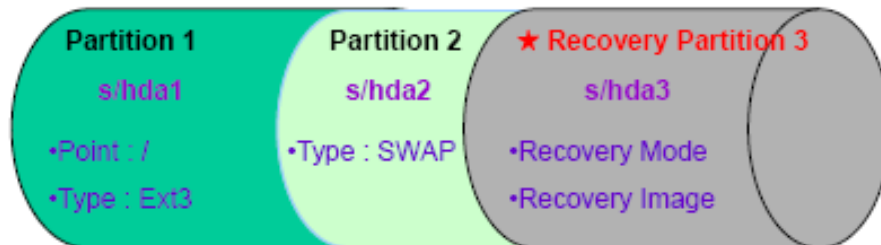

Figure B-22: Partitions for Linux

Step 3: Create a recovery partition. Insert the recovery CD into the optical disk drive.

Follow **Step 1 ~ Step 3** described in **Section B.2.2**. Then type the following commands (marked in red) to create a partition for recovery images.

```

system32>diskpart
DISKPART>list vol
DISKPART>sel disk 0
DISKPART>create part pri size= ____
DISKPART>assign letter=N
DISKPART>exit

system32>format N: /fs:ntfs /q /v:Recovery /y
system32>exit
  
```

Step 4: Build-up recovery partition. Press any key to boot from the recovery CD. It will take a while to launch the recovery tool. Please be patient. When the recovery tool setup menu appears, type <3> and press <Enter> (**Figure B-23**). The Symantec Ghost window appears and starts configuring the system to build-up a recovery partition. After completing the system configuration, press any key to reboot the system. Eject the recovery CD.

ECW-281B/B2-D525 Embedded System

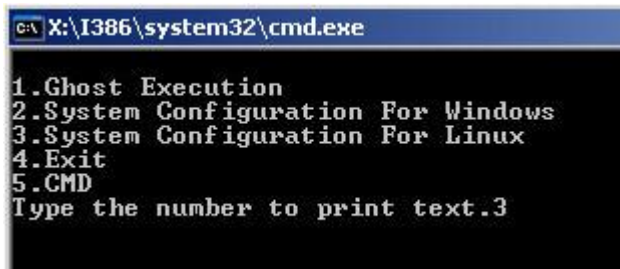

```
C:\X:\I386\system32\cmd.exe
1.Ghost Execution
2.System Configuration For Windows
3.System Configuration For Linux
4.Exit
5.CMD
Type the number to print text.3
```

Figure B-23: System Configuration for Linux

Step 5: Access the recovery tool main menu by modifying the “menu.lst”. To first access the recovery tool main menu, the menu.lst must be modified. In Linux system, enter Administrator (root). When prompt appears, type:

```
cd /boot/grub
```

```
vi menu.lst
```

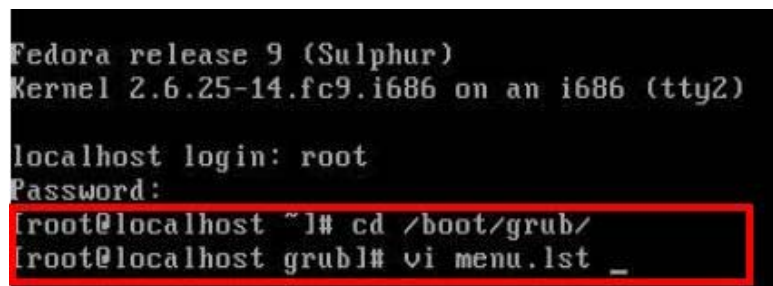

```
Fedora release 9 (Sulphur)
Kernel 2.6.25-14.fc9.i686 on an i686 (tty2)

localhost login: root
Password:
[root@localhost ~]# cd /boot/grub/
[root@localhost grub]# vi menu.lst _
```

Figure B-24: Access menu.lst in Linux (Text Mode)

Step 6: Modify the menu.lst as shown below.

```
#boot=/dev/sda
default=0
timeout=10 ← Modify timeout=10
splashimage=(hd0,0)/grub/splash.xpm.gz
hiddenmenu
title Fedora (2.6.25-14.fc9.i686)
    root (hd0,0)
    kernel /vmlinuz-2.6.25-14.fc9.i686 ro root=UUID=10f1acd
ac38b5c78910 rhgb quiet
    initrd /initrd-2.6.25-14.fc9.i686.img

title Recovery Partition
root (hd0,2)
makeactive ← Type command
chainloader +1
```

- Type command:
title Recovery Partition
root (hd0,2)
makeactive
chainloader +1

Step 7: The recovery tool menu appears. (Figure B-25)

```
1. Factory Restore
2. Backup system
3. Restore your last backup.
4. Manual
5. Quit
Please type the number to select and then press Enter:
```

Figure B-25: Recovery Tool Menu

Step 8: Create a factory default image. Follow **Step 2 ~ Step 12** described in **Section B.2.5** to create a factory default image.

B.4 Recovery Tool Functions

After completing the initial setup procedures as described above, users can access the recovery tool by pressing **<F3>** while booting up the system. The main menu of the recovery tool is shown below.

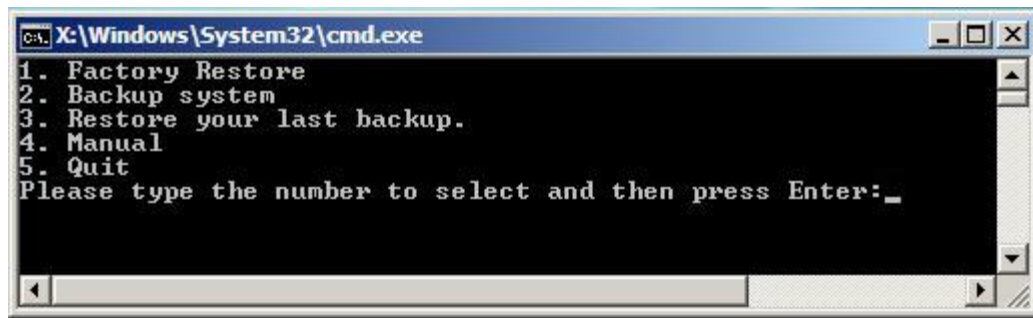

Figure B-26: Recovery Tool Main Menu

The recovery tool has several functions including:

1. **Factory Restore:** Restore the factory default image (iei.GHO) created in **Section B.2.5**.
2. **Backup system:** Create a system backup image (iei_user.GHO) which will be saved in the hidden partition.
3. **Restore your last backup:** Restore the last system backup image
4. **Manual:** Enter the Symantec Ghost window to configure manually.
5. **Quit:** Exit the recovery tool and restart the system.



WARNING:

Please do not turn off the system power during the process of system recovery or backup.



WARNING:

All data in the system will be deleted during the system recovery. Please backup the system files before restoring the system (either Factory Restore or Restore Backup).

B.4.1 Factory Restore

To restore the factory default image, please follow the steps below.

Step 1: Type <1> and press <Enter> in the main menu.

Step 2: The Symantec Ghost window appears and starts to restore the factory default. A factory default image called **iei.GHO** is created in the hidden Recovery partition.

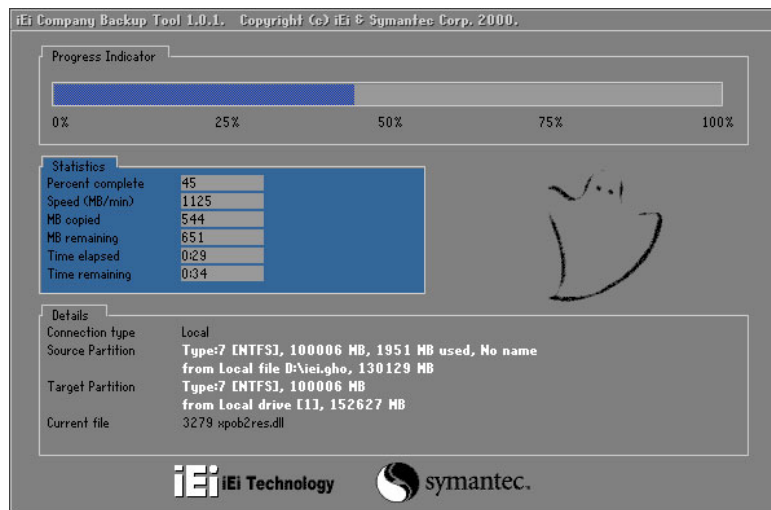

Figure B-27: Restore Factory Default

Step 3: The screen is shown as in **Figure B-28** when completed. Press any key to reboot the system.

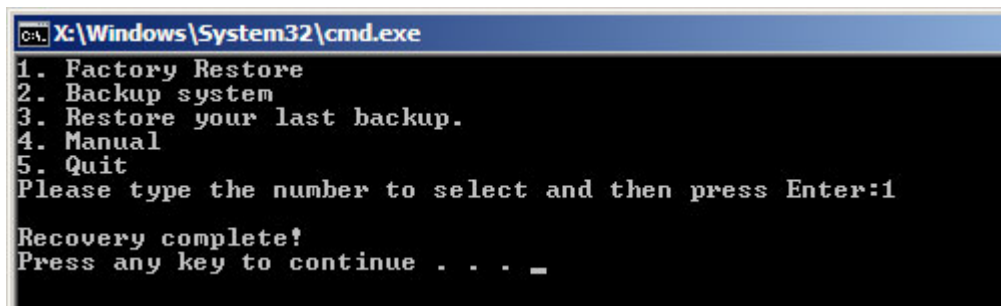

Figure B-28: Recovery Complete Window

ECW-281B/B2-D525 Embedded System

B.4.2 Backup System

To backup the system, please follow the steps below.

Step 1: Type <2> and press <Enter> in the main menu.

Step 2: The Symantec Ghost window appears and starts to backup the system. A backup image called `iei_user.GHO` is created in the hidden Recovery partition.

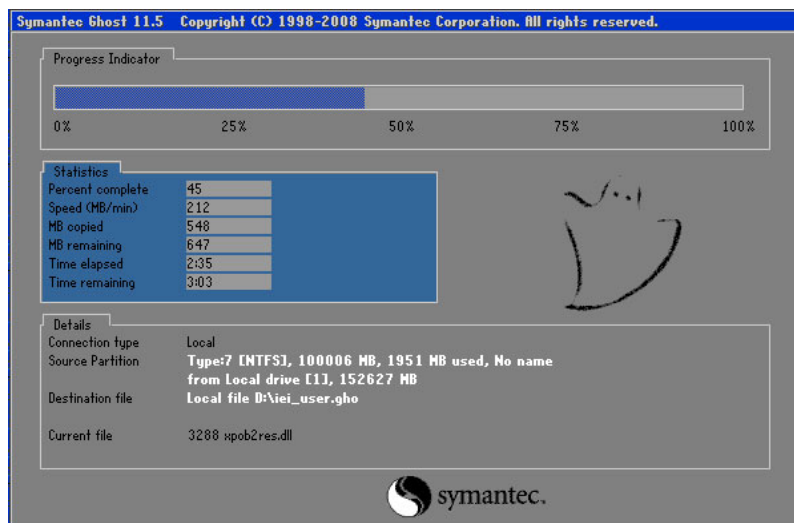

Figure B-29: Backup System

Step 3: The screen is shown as in **Figure B-30** when system backup is completed.

Press any key to reboot the system.

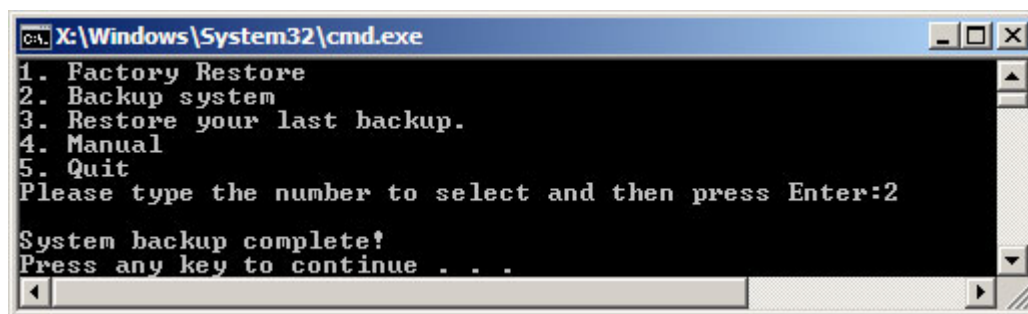

Figure B-30: System Backup Complete Window

B.4.3 Restore Your Last Backup

To restore the last system backup, please follow the steps below.

Step 1: Type <3> and press <Enter> in the main menu.

Step 2: The Symantec Ghost window appears and starts to restore the last backup image (iei_user.GHO).

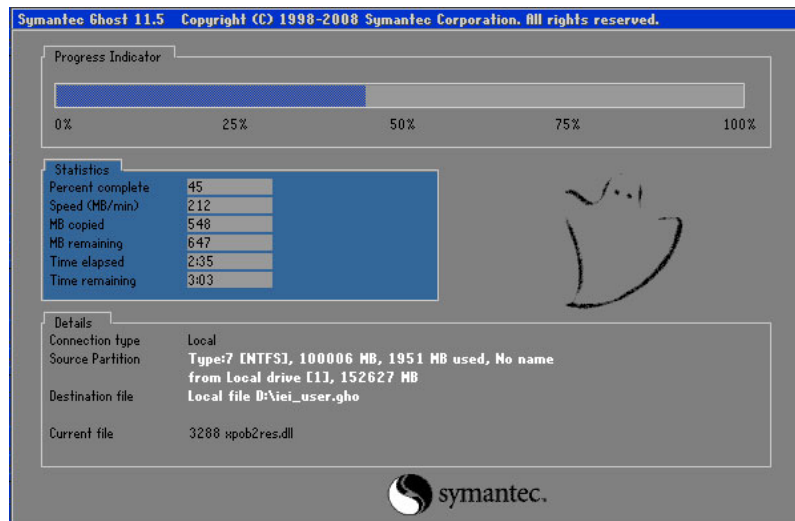

Figure B-31: Restore Backup

Step 3: The screen is shown as in **Figure B-32** when backup recovery is completed. Press any key to reboot the system.

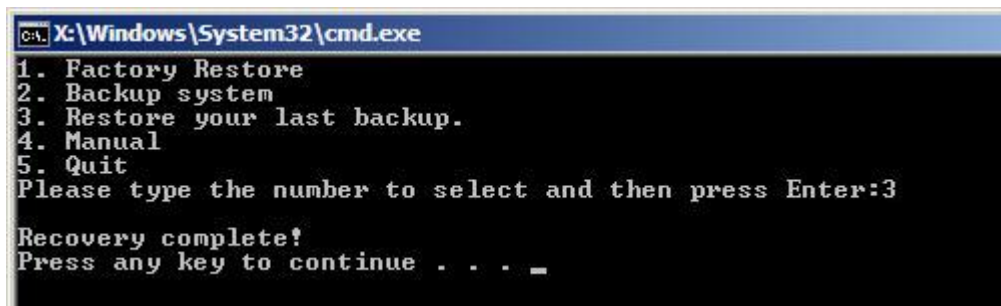

Figure B-32: Restore System Backup Complete Window

ECW-281B/B2-D525 Embedded System

B.4.4 Manual

To restore the last system backup, please follow the steps below.

Step 1: Type <4> and press <Enter> in the main menu.

Step 2: The Symantec Ghost window appears. Use the Ghost program to backup or recover the system manually.

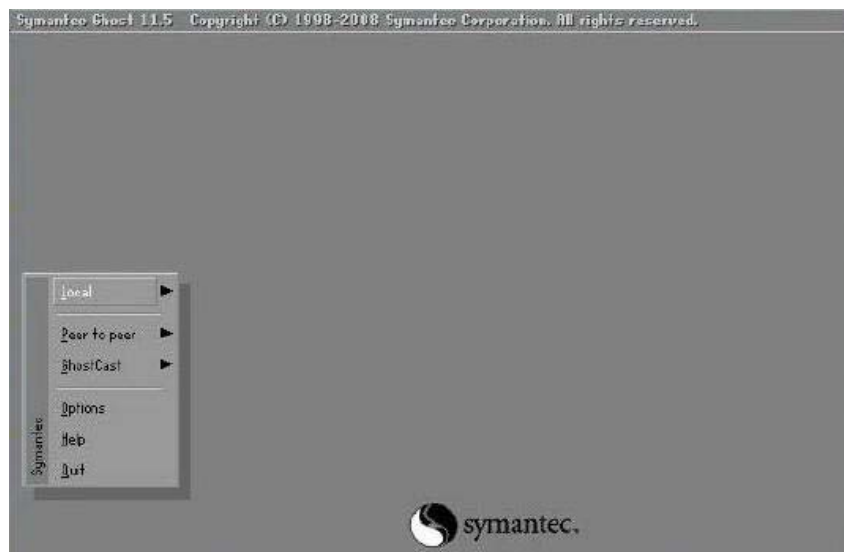

Figure B-33: Symantec Ghost Window

Step 3: When backup or recovery is completed, press any key to reboot the system.

B.5 Other Information

B.5.1 Using AHCI Mode or ALi M5283 / VIA VT6421A Controller

When the system uses AHCI mode or some specific SATA controllers such as ALi M5283 or VIA VT6421A, the SATA RAID/AHCI driver must be installed before using one key recovery. Please follow the steps below to install the SATA RAID/AHCI driver.

- Step 1:** Copy the SATA RAID/AHCI driver to a floppy disk and insert the floppy disk into a USB floppy disk drive. The SATA RAID/AHCI driver must be especially designed for the on-board SATA controller.
- Step 2:** Connect the USB floppy disk drive to the system.
- Step 3:** Insert the One Key Recovery CD into the system and boot the system from the CD.
- Step 4:** When launching the recovery tool, press <F6>.

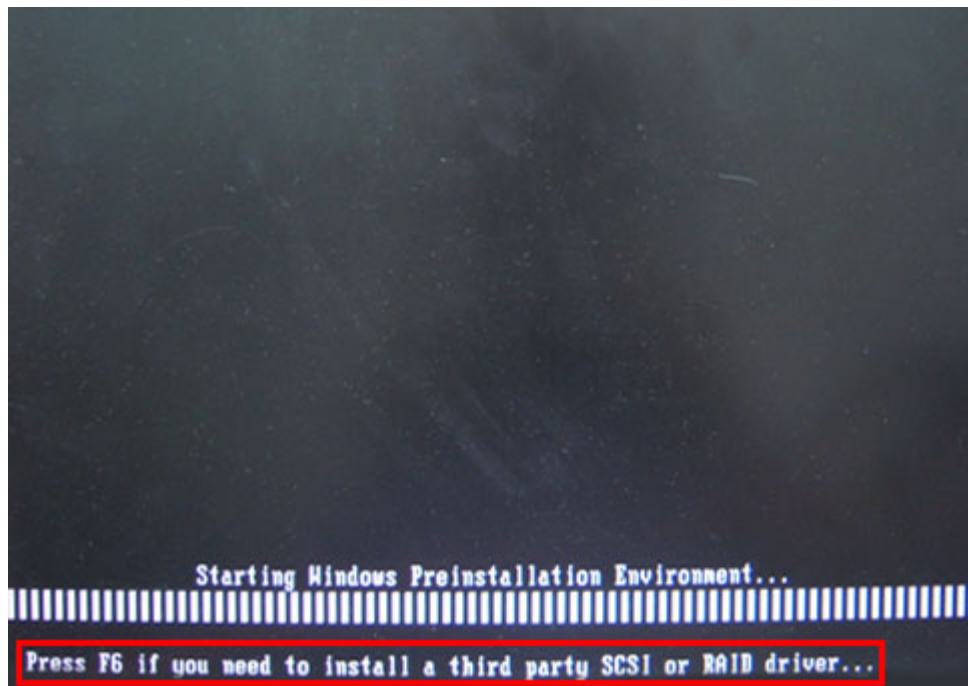

ECW-281B/B2-D525 Embedded System

Step 5: When the following window appears, press <S> to select “Specify Additional Device”.

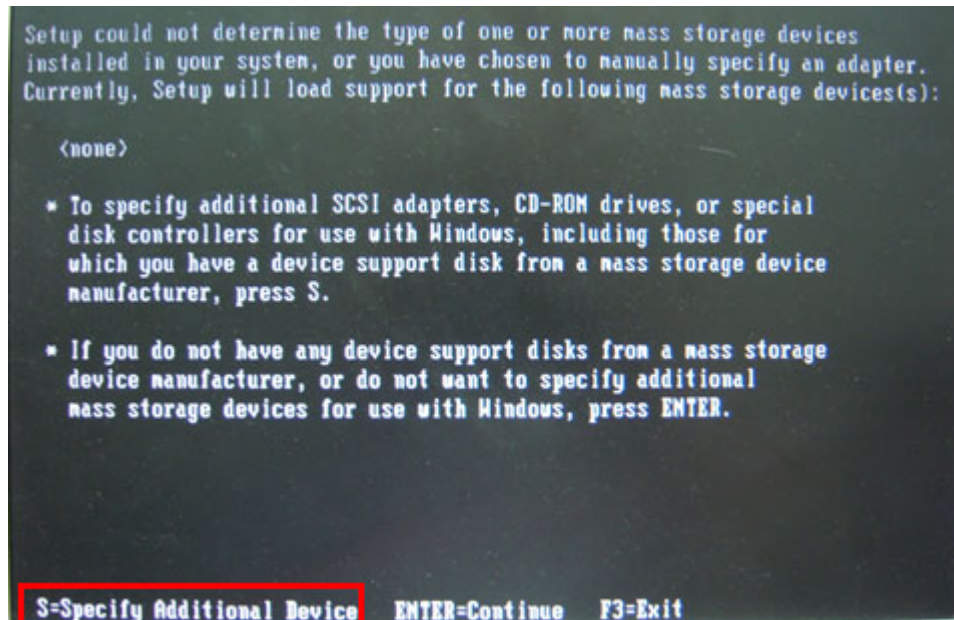

Step 6: In the following window, select a SATA controller mode used in the system. Then press <Enter>. The user can now start using the SATA HDD.

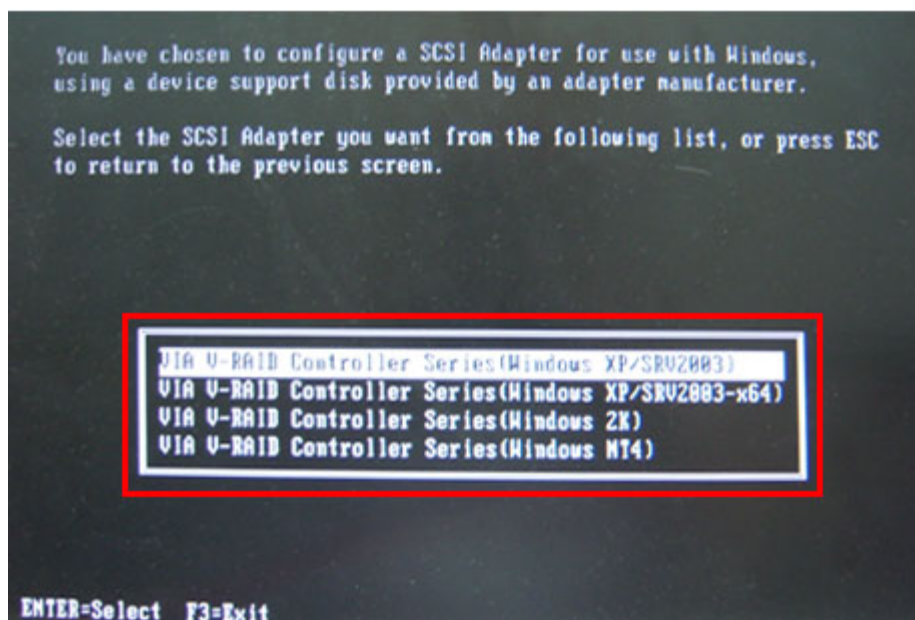

Step 7: After pressing <Enter>, the system will get into the recovery tool setup menu.

Continue to follow the setup procedure from **Step 4** in **Section B.2.2 Create Partitions** to finish the whole setup process.

B.5.2 System Memory Requirement

To be able to access the recovery tool by pressing <F3> while booting up the system, please make sure to have enough system memory. The minimum memory requirement is listed below.

- **Using Award BIOS:** 128 MB system memory
- **Using AMI BIOS:** 512 MB system memory.

Appendix

C

BIOS Menu Options

C.1 BIOS Configuration Options

Below is a list of BIOS configuration options described in **Chapter 5**.

BIOS Information	53
System Date [xx/xx/xx]	53
System Time [xx:xx:xx]	54
ACPI Sleep State [S1 (CPU Stop Clock)]	55
Hyper Threading [Enabled]	57
ATA/IDE Configurations [Enhanced]	57
Configure SATA as [IDE]	58
USB Devices	59
Legacy USB Support [Enabled]	59
Serial Port [Enabled]	60
Change Settings [Auto]	60
Serial Port [Enabled]	61
Change Settings [Auto]	61
Serial Port [Enabled]	61
Change Settings [Auto]	62
Serial Port [Enabled]	62
Change Settings [Auto]	62
Serial Port [Enabled]	63
Change Settings [Auto]	63
Serial Port [Enabled]	64
Change Settings [Auto]	64
PC Health Status	65
CPU Smart Fan control [Auto Mode]	66
Console Redirection [Disabled]	67
Terminal Type [ANSI]	67
Bits per second [115200]	68
Auto Recovery Function [Disabled]	68
Initiate Graphic Adapter	70
Share Memory Size [8 MB]	71
Multi-Monitor Support [Enabled]	71
Restore on AC Power Loss [Last State]	72

ECW-281B/B2-D525 Embedded System

HD Audio Controller [Enabled].....	72
USB Function [Enabled].....	73
USB 2.0 (EHCI) Support [Enabled].....	73
Set Spread Spectrum Function [Disabled].....	73
DVMT Mode Select [DVMT Mode].....	74
DVMT/FIXED Memory [256 MB]	74
IGD - Boot Type [VBIOS Default].....	74
LCD Panel Type [VBIOS Default].....	75
Bootup NumLock State [On].....	76
Quiet Boot [Enabled]	76
Launch PXE OpROM [Disabled].....	76
Administrator Password	77
User Password	77
Save Changes and Reset	78
Discard Changes and Reset	78
Restore Defaults	78
Save as User Defaults	78
Restore User Defaults	78

Appendix

D

Watchdog Timer



NOTE:

The following discussion applies to DOS environment. IEI support is contacted or the IEI website visited for specific drivers for more sophisticated operating systems, e.g., Windows and Linux.

The Watchdog Timer is provided to ensure that standalone systems can always recover from catastrophic conditions that cause the CPU to crash. This condition may have occurred by external EMI or a software bug. When the CPU stops working correctly, Watchdog Timer either performs a hardware reset (cold boot) or a Non-Maskable Interrupt (NMI) to bring the system back to a known state.

A BIOS function call (INT 15H) is used to control the Watchdog Timer:

INT 15H:

AH – 6FH Sub-function:	
AL – 2:	Sets the Watchdog Timer's period.
BL:	Time-out value (Its unit-second is dependent on the item "Watchdog Timer unit select" in CMOS setup).

Table D-1: AH-6FH Sub-function

Call sub-function 2 to set the time-out period of Watchdog Timer first. If the time-out value is not zero, the Watchdog Timer starts counting down. While the timer value reaches zero, the system resets. To ensure that this reset condition does not occur, calling sub-function 2 must periodically refresh the Watchdog Timer. However, the Watchdog timer is disabled if the time-out value is set to zero.

A tolerance of at least 10% must be maintained to avoid unknown routines within the operating system (DOS), such as disk I/O that can be very time-consuming.



NOTE:

When exiting a program it is necessary to disable the Watchdog Timer, otherwise the system resets.

Example program:

```

; INITIAL TIMER PERIOD COUNTER
;
W_LOOP:

    MOV     AX, 6F02H      ;setting the time-out value
    MOV     BL, 30        ;time-out value is 48 seconds
    INT     15H

;
; ADD THE APPLICATION PROGRAM HERE
;
    CMP     EXIT_AP, 1    ;is the application over?
    JNE     W_LOOP       ;No, restart the application

    MOV     AX, 6F02H     ;disable Watchdog Timer
    MOV     BL, 0        ;
    INT     15H

;
; EXIT ;

```