

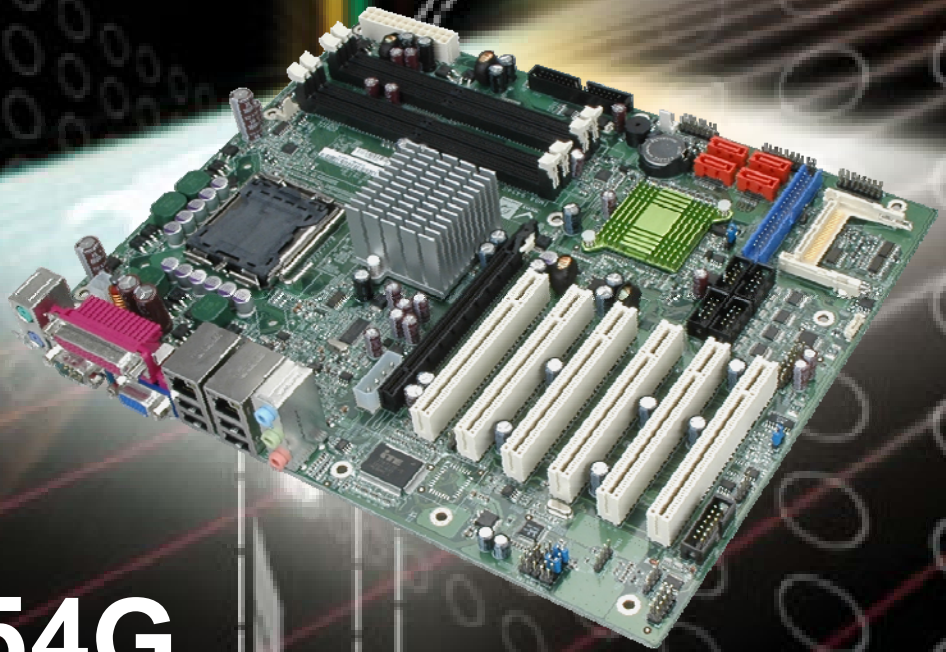

IEI Technology Corp.



**MODEL:
IMBA-9454G**

**ATX SBC Supports Intel® LGA775 Core 2 Duo™
Intel® Pentium™ 4/D, Intel® Celeron™ D, FSB 533/800/1066 MHz
PCIe x16, PCIe GbE, USB 2.0, SATA II, Audio, RoHS**

User Manual

Rev. 4.02 – November 2011



Revision

MODEL	IMBA-9454G Motherboard	
Revision Number	Description	Date of Issue
4.02	Updated Figure 5-11: COM2 Mode Selection Jumper Location	November 2011
4.01	Updated BIOS Chapter 6 to BIOS version B188MR14 and Driver Installation Chapter 7	March 2011
4.00	Changed LAN chipset from Broadcom to Realtek solution Added JSP11 jumper setting	December 2010
1.00	Initial release	March 2007

Copyright

COPYRIGHT NOTICE

The information in this document is subject to change without prior notice in order to improve reliability, design and function and does not represent a commitment on the part of the manufacturer.

In no event will the manufacturer be liable for direct, indirect, special, incidental, or consequential damages arising out of the use or inability to use the product or documentation, even if advised of the possibility of such damages.

This document contains proprietary information protected by copyright. All rights are reserved. No part of this manual may be reproduced by any mechanical, electronic, or other means in any form without prior written permission of the manufacturer.

TRADEMARKS

IBM PC is a registered trademark of International Business Machines Corporation. INTEL is a registered trademark of INTEL Corporation. Other product names mentioned herein are used for identification purposes only and may be trademarks and/or registered trademarks of their respective owners.

Packing List

**NOTE:**

If any of the components listed in the checklist below are missing, please do not proceed with the installation. Contact the IEI reseller or vendor you purchased the IMBA-9454G motherboard from or contact an IEI sales representative directly. To contact an IEI sales representative, please send an email to sales@iei.com.tw.

The items listed below should all be included in the IMBA-9454G motherboard package.

- 1 x IMBA-9454G Single Board Computer
- 1 x IDE Cable (P/N: 32200-000052-RS)
- 2 x Dual RS-232 Cable (P/N: 19800-000113-RS)
- 2 x SATA Cable (P/N: 32000-0628000-RS)
- 1 x SATA Power Cable (P/N: 32102-000100-100/200-RS)
- 1 x I/O Shielding (P/N: 45014-0017C0-00-RS)
- 1 x Mini Jumper Pack (P/N: 33100-000079-RS)
- 1 x Utility CD (P/N: IEI-7B000-000096-RS)
- 1 x One Key Recovery CD (P/N: IEI-7B000-000478-RS)
- 1 x QIG (Quick Installation Guide) (P/N: 51000-001083-RS)

Images of the above items are shown in **Chapter 3**.

Table of Contents

1 INTRODUCTION.....	2
1.1 OVERVIEW.....	3
1.1.1 Features	3
1.1.2 Connectors	5
1.1.3 Technical Specifications.....	7
2 DETAILED SPECIFICATIONS	9
2.1 OVERVIEW.....	11
2.2 DIMENSIONS.....	11
2.2.1 Board Dimensions.....	11
2.2.2 External Interface Panel Dimensions	12
2.3 DATA FLOW	13
2.4 COMPATIBLE PROCESSORS	13
2.4.1 CPU Overview	13
2.4.2 Supported Intel® Core™ 2 Duo Processors	14
2.4.3 Supported Intel® Pentium® 4 Processors.....	14
2.4.4 Supported Intel® Pentium® D Processors.....	15
2.4.5 Supported Intel® Celeron® D Processors	15
2.5 INTEL® 945G NORTHBRIDGE CHIPSET.....	15
2.5.1 Intel® 945G Overview.....	15
2.5.2 Intel® 945G Memory Support	16
2.5.3 Intel® 945G Integrated Graphics Media Accelerator 950.....	16
2.6 INTEL® ICH7 SOUTHBRIDGE CHIPSET	17
2.6.1 Intel® ICH7 Overview.....	17
2.6.2 Realtek ALC655 Audio Codec '97 Controller.....	18
2.6.3 Intel® ICH7 IDE Interface	18
2.6.4 Intel® ICH7 PCI Interface	19
2.6.5 Intel® ICH7 Real Time Clock.....	19
2.6.6 Intel® ICH7 SATA Controller.....	19
2.6.7 Intel® ICH7 USB Controller	20
2.7 PCI BUS COMPONENTS	20

2.7.1 PCI Bus Overview.....	20
2.7.2 Realtek LAN interface	20
2.7.3 BIOS Chipset.....	20
2.7.4 Super I/O chipset.....	21
2.7.4.1 Super I/O LPC Interface	21
2.7.4.2 Super I/O 16C550 UARTs	21
2.7.4.3 Super I/O Enhanced Hardware Monitor	22
2.7.4.4 Super I/O Fan Speed Controller.....	22
2.7.4.5 Super I/O Parallel Port	22
2.7.4.6 Super I/O Keyboard Controller.....	22
2.8 ENVIRONMENTAL AND POWER SPECIFICATIONS	23
2.8.1 System Monitoring	23
2.8.2 Operating Temperature and Temperature Control.....	24
2.8.3 Power Consumption.....	24
3 UNPACKING	25
3.1 ANTI-STATIC PRECAUTIONS	27
3.2 UNPACKING	28
3.2.1 Unpacking Precautions.....	28
3.3 UNPACKING CHECKLIST	28
3.3.1 Package Contents.....	28
3.3.2 Optional Components	30
4 CONNECTOR PINOUTS.....	31
4.1 PERIPHERAL INTERFACE CONNECTORS.....	33
4.1.1 IMBA-9454G Layout.....	33
4.1.2 Peripheral Interface Connectors	33
4.1.3 External Peripheral Interface Panel Connectors	35
4.2 INTERNAL PERIPHERAL CONNECTORS	35
4.2.1 ATX Power Supply Connector (4-pins).....	35
4.2.2 ATX Power Supply Connector (24-pins).....	36
4.2.3 Audio Connector (8-pin).....	37
4.2.4 Auxiliary Audio Connector (4-pin)	38
4.2.5 CD-In Connector	39
4.2.6 Compact Flash Socket.....	40

IMBA-9454G Motherboard

4.2.7 Digital Input/Output (DIO) Connector.....	41
4.2.8 Fan Connectors.....	42
4.2.9 Floppy Disk Connector.....	43
4.2.10 Front Panel Audio Connector.....	45
4.2.11 IDE Connector (40-pin).....	45
4.2.12 Infrared Interface Connector (5-pin).....	47
4.2.13 Multi-panel Connector.....	48
4.2.14 PCI Express x16 Slot.....	49
4.2.15 PCI Express Power Connector (4-pin).....	52
4.2.16 PCI Slot.....	53
4.2.17 SATA Drive Connectors.....	56
4.2.18 Serial Port Connector (RS-232).....	57
4.2.19 Serial Port Connector (RS-232/422/485).....	58
4.2.20 Serial Port Connector (RS-422/485).....	59
4.2.21 SPDIF Connector.....	60
4.2.22 TPM Connector.....	61
4.2.23 USB Connectors (Internal).....	62
4.3 EXTERNAL PERIPHERAL INTERFACE CONNECTORS.....	63
4.3.1 Keyboard/Mouse Connector.....	63
4.3.2 Parallel Port Connector.....	64
4.3.3 Ethernet Connector.....	65
4.3.4 Audio Connectors.....	67
4.3.5 USB Connectors.....	67
4.3.6 VGA Connector.....	68
4.3.7 Serial Communications Connector.....	69
4.4 ON-BOARD JUMPERS.....	70
5 INSTALLATION.....	71
5.1 ANTI-STATIC PRECAUTIONS.....	73
5.2 INSTALLATION CONSIDERATIONS.....	73
5.2.1 Installation Notices.....	74
5.2.2 Installation Checklist.....	74
5.3 CPU, CPU COOLING KIT AND DIMM INSTALLATION.....	76
5.3.1 LGA775 CPU Installation.....	76
5.3.2 LGA775 Cooling Kit Installation.....	80

5.3.3 DIMM Installation	82
5.4 JUMPER SETTINGS	83
5.4.1 CF Master/Slave Selection.....	84
5.4.2 Clear CMOS Jumper.....	84
5.4.3 COM2 Mode Selection.....	85
5.4.4 SPI Flash Connector.....	86
5.5 CHASSIS INSTALLATION.....	87
5.5.1 Airflow.....	87
5.6 INTERNAL PERIPHERAL DEVICE CONNECTIONS.....	87
5.6.1 Peripheral Device Cables.....	87
5.6.2 ATA Flat Cable Connection	88
5.6.3 Dual RS-232 Cable Connection.....	89
5.6.4 SATA Drive Connection	90
5.7 EXTERNAL PERIPHERAL INTERFACE CONNECTION	91
5.7.1 PS/2 Keyboard/Mouse Connection	92
5.7.2 Parallel Device Connection.....	93
5.7.3 RJ-45 Ethernet Connection.....	93
5.7.4 USB Connection.....	94
5.7.5 Audio Connection.....	95
5.7.6 VGA Monitor Connection	96
5.7.7 Serial Device Connection	97
6 AMI BIOS.....	99
6.1 INTRODUCTION.....	101
6.1.1 Starting Setup.....	101
6.1.2 Using Setup	101
6.1.3 Getting Help.....	102
6.1.4 Unable to Reboot After Configuration Changes.....	102
6.1.5 BIOS Menu Bar.....	102
6.2 MAIN.....	103
6.3 ADVANCED.....	104
6.3.1 CPU Configuration.....	105
6.3.2 IDE Configuration	106
6.3.2.1 IDE Master, IDE Slave	108
6.3.3 Floppy Configuration.....	111

IMBA-9454G Motherboard

6.3.4 Super IO Configuration	112
6.3.5 Hardware Health Configuration.....	117
6.3.6 Power Configuration.....	119
6.3.6.1 ACPI Configuration	119
6.3.6.2 APM Configuration.....	120
6.3.7 Remote Access Configuration.....	123
6.3.8 Trusted Computing	126
6.3.9 USB Configuration.....	127
6.4 PCI/PNP.....	128
6.5 BOOT.....	131
6.5.1 Boot Settings Configuration.....	132
6.5.2 Boot Device Priority	134
6.5.3 Removable Drives	134
6.6 SECURITY.....	135
6.7 CHIPSET	136
6.7.1 NorthBridge Configuration.....	137
6.7.2 SouthBridge Configuration.....	139
6.8 EXIT	141
7 DRIVER INSTALLATION.....	143
7.1 AVAILABLE SOFTWARE DRIVERS	145
7.2 DRIVER CD AUTO-RUN	145
7.3 CHIPSET DRIVER INSTALLATION.....	147
7.4 INTEL GRAPHICS MEDIA ACCELERATOR DRIVER.....	150
7.5 REALTEK LAN DRIVER (FOR GbE LAN) INSTALLATION	153
7.6 REALTEK AC`97 AUDIO DRIVER (ALC655) INSTALLATION	156
7.6.1 BIOS Setup.....	156
7.6.2 Driver Installation	156
A BIOS MENU OPTIONS	160
A.1 BIOS CONFIGURATION OPTIONS	162
B WATCHDOG TIMER.....	165
C ADDRESS MAPPING	169
C.1 IO ADDRESS MAP.....	171



C.2 1ST MB MEMORY ADDRESS MAP 172

C.3 IRQ MAPPING TABLE 173

C.4 DMA CHANNEL ASSIGNMENTS 173

D EXTERNAL AC'97 AUDIO CODEC 174

D.1 INTRODUCTION..... 176

D.1.1 Accessing the AC'97 CODEC..... 176

D.1.2 Driver Installation..... 176

D.2 SOUND EFFECT CONFIGURATION..... 177

D.2.1 Accessing the Sound Effects Manager 177

D.2.2 Sound Effect Manager Configuration Options 178

INDEX..... 181

List of Figures

Figure 1-1: IMBA-9454G	3
Figure 1-2: IMBA-9454G Connectors	5
Figure 2-1: IMBA-9454G Dimensions (mm).....	11
Figure 2-2: External Interface Panel Dimensions (mm).....	12
Figure 2-3: Data Flow Block Diagram.....	13
Figure 2-4: 240-pin DIMM Sockets	16
Figure 4-1: Connector and Jumper Locations.....	33
Figure 4-2: ATX Power Supply Connector (4-pins) Location.....	36
Figure 4-3: ATX Power Connector Location	37
Figure 4-4: Audio Connector Location (8-pin).....	38
Figure 4-5: Auxiliary Audio Connector Location (4-pin).....	39
Figure 4-6: CD-In Connector.....	39
Figure 4-7: CF Card Socket Location	40
Figure 4-8: DIO Connector Locations.....	42
Figure 4-9: Fan Connectors Locations.....	43
Figure 4-10: FDC Connector Location.....	44
Figure 4-11: Front Panel Connector Pinout Locations	45
Figure 4-12: IDE Device Connector Locations	46
Figure 4-13: Infrared Connector Pinout Locations	47
Figure 4-14: Multi-panel Connector Location	48
Figure 4-15: PCI Express x16 Slot Connector Location	50
Figure 4-16: PCI Express Power Connector Pinout Locations.....	53
Figure 4-17: PCI Slot Location	54
Figure 4-18: SATA Drive Connector Locations	57
Figure 4-19: Serial Port Connector (RS-232) Pinout Locations	58
Figure 4-20: Serial Port Connector (RS-232/422/485) Pinout Locations.....	59
Figure 4-21: Serial Port Connector (RS-422/485) Pinout Locations	60
Figure 4-22: SPDIF Connector Pinout Locations	60
Figure 4-23: TPM Connector Pinout Locations	61
Figure 4-24: USB Connector Pinout Locations	62
Figure 4-25: IMBA-9454G External Interface Connectors.....	63

Figure 4-26: PS/2 Pinouts	64
Figure 4-27: Parallel Port Connector Pinout Locations.....	65
Figure 4-28: Ethernet Connector Pinout Locations	66
Figure 4-29: Ethernet Connector.....	66
Figure 4-30: Audio Connector	67
Figure 4-31: USB Connector Pinout Locations	68
Figure 4-32: VGA Connector	68
Figure 4-33: Serial Communications Connector Pinout Locations.....	69
Figure 5-1: Intel LGA775	77
Figure 5-2: Remove the CPU Socket Protective Shield	77
Figure 5-3: Open the CPU Socket Load Plate.....	78
Figure 5-4: Insert the LGA775 CPU.....	79
Figure 5-5: IEI Cooling Kits.....	80
Figure 5-6: Securing the Heat sink to the PCB Board	81
Figure 5-7: Installing a DIMM.....	82
Figure 5-8: Jumper Locations	83
Figure 5-9: Jumper Locations	84
Figure 5-10: Clear CMOS Jumper Location	85
Figure 5-11: COM2 Mode Selection Jumper Location	86
Figure 5-12: SPI Flash Jumper Location.....	87
Figure 5-13: IDE Cable Connection.....	88
Figure 5-14: Dual RS-232 Cable Installation	89
Figure 5-15: SATA Drive Cable Connection.....	90
Figure 5-16: SATA Power Drive Connection.....	91
Figure 5-17: PS/2 Keyboard/Mouse Connector	92
Figure 5-18: Parallel Device Connector.....	93
Figure 5-19: RJ-45 Ethernet Connector.....	94
Figure 5-20: USB Connector.....	95
Figure 5-21: Audio Connectors	96
Figure 5-22: VGA Connector	97
Figure 5-23: Serial Device Connector.....	98
Figure 7-1: Introduction Screen	146
Figure 7-2: Available Drivers	146
Figure 7-3: Chipset Driver Installation Program.....	147
Figure 7-4: Chipset Driver Installation Welcome Screen.....	148

IMBA-9454G Motherboard

Figure 7-5: Chipset Driver Installation License Agreement	148
Figure 7-6: Chipset Driver Readme File Information	149
Figure 7-7: Chipset Driver Installation Complete	149
Figure 7-8: VGA Driver	150
Figure 7-9: Intel® Graphics Media Accelerator InstallShield Wizard	151
Figure 7-10: Intel® Graphics Media Accelerator Driver Welcome Screen	151
Figure 7-11: Intel® Graphics Media Accelerator Driver License Agreement	152
Figure 7-12: Intel® Graphics Media Accelerator Driver Readme.....	152
Figure 7-13: Intel® Graphics Media Accelerator Installation Complete.....	153
Figure 7-14: LAN Driver	154
Figure 7-15: Locate the Setup Icon.....	154
Figure 7-16: Realtek LAN Driver InstallShield Wizard	155
Figure 7-17: Realtek LAN Driver Install	155
Figure 7-18: Realtek LAN Driver Complete	156
Figure 7-19: Select the Audio CODEC.....	157
Figure 7-20: Locate the Setup Program Icon.....	157
Figure 7-21: InstallShield Wizard Welcome Screen	158
Figure 7-22: Audio Driver Digital Signal.....	158
Figure 7-23: Restart the Computer	159

List of Tables

Table 1-1: Technical Specifications	8
Table 2-1: Supported Intel® Core™ 2 Duo Processors	14
Table 2-2: Supported Intel® Pentium® 4 Processors	14
Table 2-3: Supported Intel® Pentium® D Processors	15
Table 2-4: Supported Intel® Celeron® D Processors	15
Table 2-5: Supported HDD Specifications	19
Table 2-6: Power Consumption	24
Table 3-1: Package List Contents	29
Table 3-2: Optional Components	30
Table 4-1: Peripheral Interface Connectors	35
Table 4-2: External Peripheral Interface Panel Connectors	35
Table 4-3: ATX Power Supply Connector (4-pins) Pinouts	36
Table 4-4: ATX Power Connector Pinouts	37
Table 4-5: Audio Connector Pinouts (8-pin)	38
Table 4-6: Auxiliary Audio Connector Pinouts (4-pin)	39
Table 4-7: CD-In Connector	40
Table 4-8: CF Card Socket Pinouts	41
Table 4-9: DIO Connector Pinouts	42
Table 4-10: Fan Connectors Pinouts	43
Table 4-11: FDC Connector Pinouts	44
Table 4-12: Front Panel Connector Pinouts	45
Table 4-13: IDE Connector Pinouts	47
Table 4-14: Infrared Connector Pinouts	48
Table 4-15: Multi-panel Connector Pinouts	49
Table 4-16: PCIe x16 Side A Pinouts	51
Table 4-17: PCIe x16 Side B Pinouts	52
Table 4-18: PCI Express Power Connector Pinouts	53
Table 4-19: PCI Slot	56
Table 4-20: SATA Drive Connector Pinouts	57
Table 4-21: Serial Port Connector (RS-232) Pinouts	58
Table 4-22: Serial Port Connector (RS-232/422/485) Pinouts	59

IMBA-9454G Motherboard

Table 4-23: Serial Port Connector (RS-422/485) Pinouts.....	60
Table 4-24: SPDIF Connector Pinouts.....	61
Table 4-25: TPM Connector Pinouts.....	62
Table 4-26: USB Port Connector Pinouts.....	62
Table 4-27: PS/2 Connector Pinouts.....	64
Table 4-28: Parallel Port Connector Pinouts.....	65
Table 4-29: Ethernet Connector Pinouts.....	66
Table 4-30: Ethernet Connector LEDs.....	67
Table 4-31: USB Connector Pinouts.....	68
Table 4-32: VGA Connector Pinouts.....	69
Table 4-33: COM1 RS-232 Mode Connector Pinouts.....	70
Table 5-1: Jumpers.....	83
Table 5-2: CF Master/Slave Selection Settings.....	84
Table 5-3: Clear CMOS Jumper Settings.....	85
Table 5-4: COM2 Mode Selection Jumper Settings.....	86
Table 5-5: SPI Flash Jumper Settings.....	86
Table 5-6: IEI Provided Cables.....	88
Table 6-1: BIOS Navigation Keys.....	102

List of BIOS Menus

BIOS Menu 1: Main	103
BIOS Menu 2: Advanced	105
BIOS Menu 3: CPU Configuration	105
BIOS Menu 4: IDE Configuration	106
BIOS Menu 5: IDE Master and IDE Slave Configuration	108
BIOS Menu 6: Floppy Configuration	112
BIOS Menu 7: Super IO Configuration	113
BIOS Menu 8: Hardware Health Configuration	117
BIOS Menu 9: Power Configuration	119
BIOS Menu 10: ACPI Configuration	120
BIOS Menu 11: APM Configuration	121
BIOS Menu 12: Remote Access Configuration	124
BIOS Menu 13: Trusted Computing	126
BIOS Menu 14: USB Configuration	127
BIOS Menu 15: PCI/PnP Configuration	129
BIOS Menu 16: Boot	131
BIOS Menu 17: Boot Settings Configuration	132
BIOS Menu 18: Boot Device Priority Settings	134
BIOS Menu 19: Removable Drives	135
BIOS Menu 20: Security	135
BIOS Menu 21: Chipset	137
BIOS Menu 22: Northbridge Chipset Configuration	137
BIOS Menu 23: Southbridge Chipset Configuration	140
BIOS Menu 24: Exit	141

Glossary

IMBA-9454G Motherboard

AC'97	Audio Codec 97	HDD	Hard Disk Drive
ACPI	Advanced Configuration and Power Interface	IDE	Integrated Data Electronics
APM	Advanced Power Management	I/O	Input/Output
ARMD	ATAPI Removable Media Device	ICH4	I/O Controller Hub 4
ASKIR	Shift Keyed Infrared	L1 Cache	Level 1 Cache
ATA	Advanced Technology Attachments	L2 Cache	Level 2 Cache
BIOS	Basic Input/Output System	LCD	Liquid Crystal Display
CFII	Compact Flash Type 2	LPT	Parallel Port Connector
CMOS	Complementary Metal Oxide Semiconductor	LVDS	Low Voltage Differential Signaling
CPU	Central Processing Unit	MAC	Media Access Controller
Codec	Compressor/Decompressor	OS	Operating System
COM	Serial Port	PCI	Peripheral Connect Interface
DAC	Digital to Analog Converter	PIO	Programmed Input Output
DDR	Double Data Rate	PnP	Plug and Play
DIMM	Dual Inline Memory Module	POST	Power On Self Test
DIO	Digital Input/Output	RAM	Random Access Memory
DMA	Direct Memory Access	SATA	Serial ATA
EIDE	Enhanced IDE	S.M.A.R.T	Self Monitoring Analysis and Reporting Technology
EIST	Enhanced Intel SpeedStep Technology	SPD	Serial Presence Detect
FDD	Floppy Disk Drive	S/PDI	Sony/Philips Digital Interface
FDC	Floppy Disk Connector	SDRAM	Synchronous Dynamic Random Access Memory
FFIO	Flexible File Input/Output	SIR	Serial Infrared
FIFO	First In/First Out	UART	Universal Asynchronous Receiver-transmitter
FSB	Front Side Bus	USB	Universal Serial Bus
IrDA	Infrared Data Association	VGA	Video Graphics Adapter



Chapter

1

Introduction

IMBA-9454G Motherboard

1.1 Overview

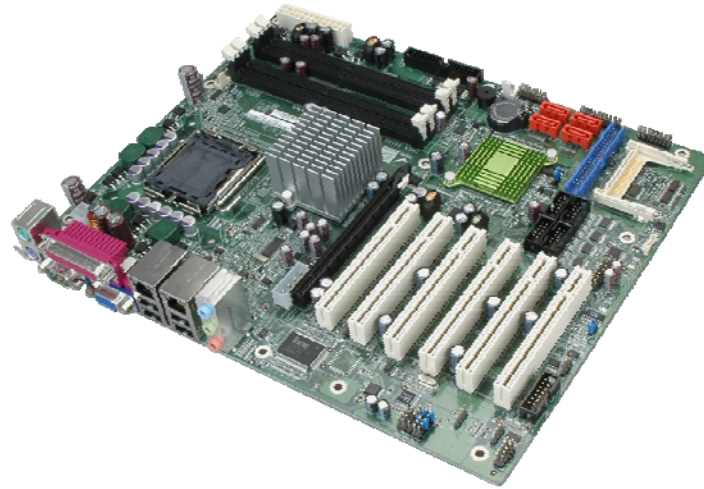

Figure 1-1: IMBA-9454G

The IMBA-9454G motherboard is an LGA775 Intel® Core™ 2 Duo/Intel® Pentium® 4/Intel® Pentium® D/Intel® Celeron® D CPU platform with an Intel® 945G Express Chipset and Intel® I/O Controller Hub 7 (ICH7) Southbridge. The IMBA-9454G has a maximum front side bus (FSB) frequency of 1066MHz, supports up to 4GB of dual channel 677MHz DDR2 RAM and comes with VGA, PS/2 keyboard/mouse, COM port, serial port and audio interfaces as well as a Realtek RTL8111E LAN controller. The IMBA-9454G supports up to four serial ATA (SATA 3Gb/s) hard disk drives and up to eight USB 2.0 devices. Optional VGA or DVI Serial Digital Video Output (SDVO) cards, supporting dual display and TPM modules offering advanced security features are available for the system and can be purchased separately. If RAID support for the system is required, please contact an IEI sales representative, or send an email to sales@iei.com.tw.

1.1.1 Features

Some of the IMBA-9454G features are listed below.

- RoHS compliant
- Support for the following CPUs:
 - LGA775 Intel® Core™ 2 Duo
 - LGA775 Intel® Pentium® 4
 - LGA775 Intel® Pentium® D

- LGA775 Intel® Celeron® D
- Integrated Intel® GMA950 graphics engine
- Maximum FSB of 1066MHz
- Four 240-pin dual channel 400/533/677MHz DDR2 SDRAM DIMMs support up to 4GB of memory
- High performance PCIe Gigabit Ethernet chipset (LAN1 with ASF2.0 remote control support)
- Four SATA 3Gb/s drives supported
- Two Ultra ATA 100, Ultra ATA 66 or Ultra ATA 33 IDE HDDs supported
- Eight USB 2.0 devices supported
- ATX power only
- 5.1 channel surround sound supported
- TPM V1.2 hardware security function supported
- PCI expansion:
 - 1 x PCI Express x16 expansion slot
 - 6 x PCI expansion slots

IMBA-9454G Motherboard

1.1.2 Connectors

The IMBA-9454G has a wide variety of internal and external peripheral connectors. The peripheral connectors are connected to devices including storage devices, display devices and parallel communications devices. A labeled photo of the peripheral connectors is shown in Figure 1-2.

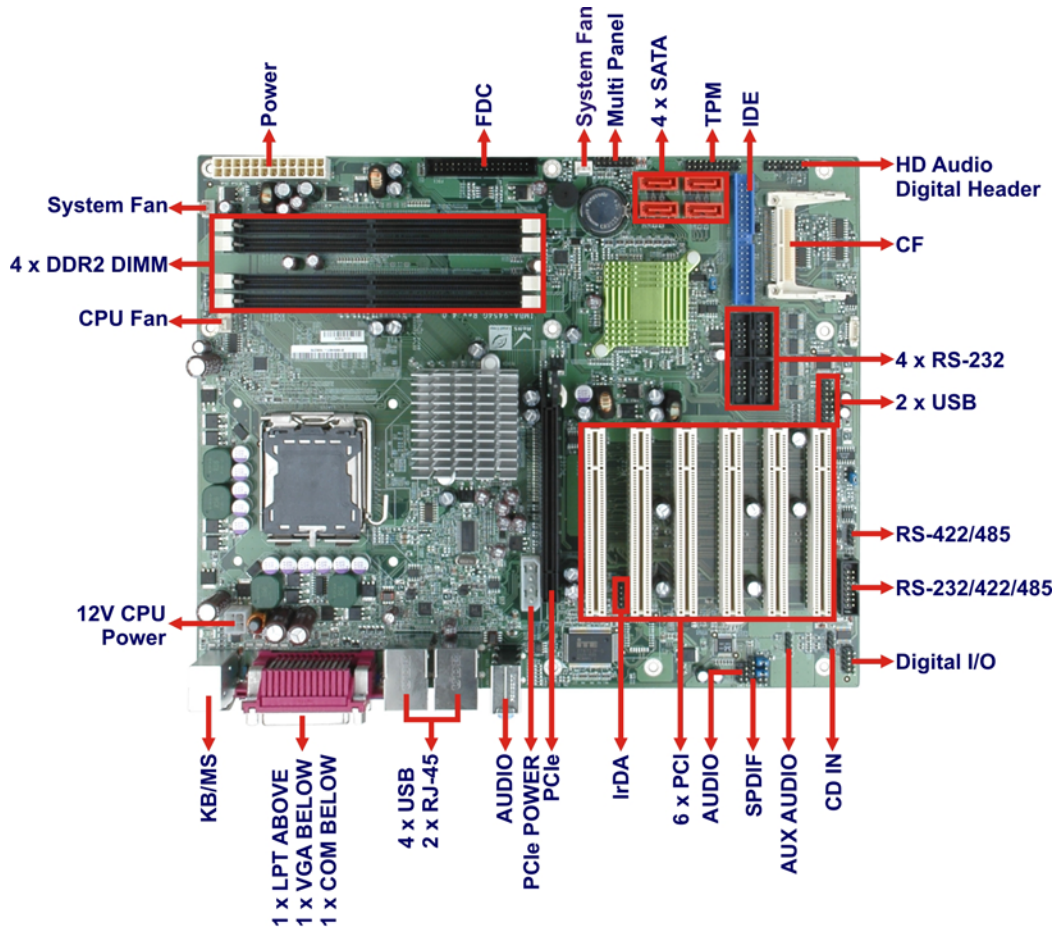

Figure 1-2: IMBA-9454G Connectors

The IMBA-9454G has the following on-board connectors:

- 1 x 12V power connector
- 1 x ATX power connector
- 1 x Audio connector
- 1 x Aux. Audio connector

- 1 x CD-in connector
- 1 x CompactFlash slot
- 4 x DDR2 DIMM slots
- 1 x DIO connector
- 3 x Fan connectors
- 1 x Floppy disk connector
- 1 x IDE disk drive connector
- 1 x Infrared interface connector
- 1 x Multi panel connector
- 1 x PCIe slot
- 6 x PCI slots
- 4 x Serial ATA (SATA) drive connectors
- 6 x Serial port connectors
- 1 x SPDIF connector
- 1 x TPM connector
- 2 x USB connectors

The IMBA-9454G has the following external peripheral interface connectors on the board rear panel:

- 1 x PS/2 dual keyboard/mouse connector
- 1 x Parallel port connector
- 1 x Serial port connector
- 1 x VGA connector
- 2 x Ethernet connectors
- 4 x USB connectors
- 3 x Audio connectors

The IMBA-9454G has the following on-board jumpers:

- CF Master/Slave Selection
- Clear CMOS
- COM2 RS-232/422/485 Selection

IMBA-9454G Motherboard

1.1.3 Technical Specifications

IMBA-9454G technical specifications are listed in Table 1-1. Detailed descriptions of each specification can be found in Chapter 2.

Specification	IMBA-9454G
Form Factor	ATX motherboard
System CPU	LGA775 Intel® Core™ 2 Duo (up to 2.66GHz) LGA775 Intel® Pentium® 4 (up to 3.8GHz) LGA775 Intel® Pentium® D (up to 3.6GHz) LGA775 Intel® Celeron® D (up to 3.6GHz) (Hyperthreading Technology supported)
Front Side Bus	533MHz, 800MHz or 1066MHz
System Chipset	Northbridge: Intel® 945G Express Southbridge: Intel® ICH7
Memory	Four 240-pin DDR2 DIMM slots support four 1GB, 400MHz, 533MHz or 667MHz DDR2 SDRAM DIMMs
Display	CRT: Intel® Graphics Media Accelerator (GMA) 950 integrated with DB-15 VGA connector
BIOS	AMI BIOS
Audio	5.1 channel audio via pin header
LAN	Realtek RTL8111E LAN controller

Specification	IMBA-9454G
COM	Six on-board serial ports: Four on-board RS-232 serial ports One on-board RS-232/422/485 serial port (by jumper setting) One on-board RS-422/485 serial port (by jumper setting)
USB 2.0	Eight USB 2.0 devices supported
IDE	One 40-pin IDE connects up to two Ultra ATA33/66/100 devices
Floppy Disk	One FDD connector supports one floppy disk drive
SATA	Four SATA 3Gb/s drives supported
Keyboard/mouse	One PS/2 connector supports mouse and keyboard connectivity
Watchdog Timer	Software programmable 1-255 sec. by supper I/O
Power Supply	+5V@2.86A, +12V@0.39A, +3.3V@6.24A (Intel® Core™ 2 Duo E7400 2.8 GHz/1066 MHz CPU with 2 x 2GB DDR2 800 MHz)
Temperature	0°C ~ 60°C (32°F ~140°F)
Humidity (operating)	5%~95% non-condensing
Dimensions	305mm x 244mm
Weight (GW/NW)	1.2kg/0.65kg

Table 1-1: Technical Specifications

Chapter

2

Detailed Specifications

IMBA-9454G Motherboard

2.1 Overview

This chapter describes the specifications and on-board features of the IMBA-9454G in detail.

2.2 Dimensions

2.2.1 Board Dimensions

The dimensions of the board are listed below and shown in Figure 2-1.

- **Length:** 305 mm
- **Width:** 244 mm

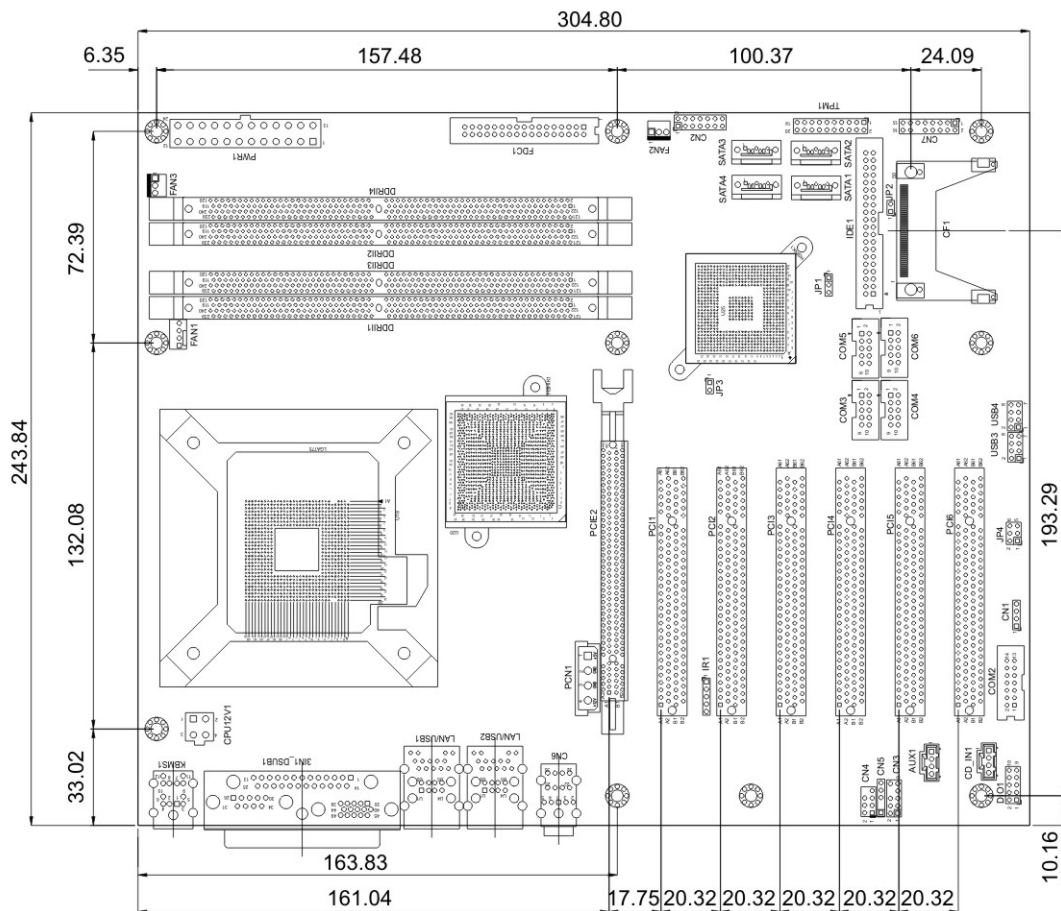

Figure 2-1: IMBA-9454G Dimensions (mm)

2.2.2 External Interface Panel Dimensions

External peripheral interface connector panel dimensions are shown in Figure 2-2.

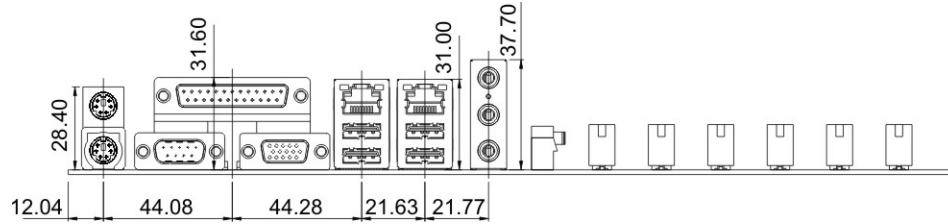

Figure 2-2: External Interface Panel Dimensions (mm)

2.4.2 Supported Intel® Core™ 2 Duo Processors

Specifications for the compatible Intel® Core™ 2 Duo processors are listed in Table 2-1.

CPU Speed	Bus Speed	Mfg. Tech	Cache	Package	Processor No.
2.66 GHz	1066 MHz	65 nm	4 MB	LGA775	E6700
2.40 GHz	1066 MHz	65 nm	4 MB	LGA775	E6600
2.13 GHz	1066 MHz	65 nm	2 MB	LGA775	E6400
1.86 GHz	1066 MHz	65 nm	2 MB	LGA775	E6300
1.80 GHz	800 MHz	65 nm	2 MB	LGA775	E4300

Table 2-1: Supported Intel® Core™ 2 Duo Processors

2.4.3 Supported Intel® Pentium® 4 Processors

Specifications for the compatible Intel® Pentium® 4 processors are listed in Table 2-2.

CPU Speed	Bus Speed	Mfg. Tech	Cache	Package	Processor No.
3.80 GHz	800 MHz	90 nm	2 MB	LGA775	672
3.80 GHz	800 MHz	90 nm	1 MB	LGA775	570J
3.80 GHz	800 MHz	90 nm	1 MB	LGA775	571

Table 2-2: Supported Intel® Pentium® 4 Processors

IMBA-9454G Motherboard

2.4.4 Supported Intel® Pentium® D Processors

Specifications for the compatible Intel® Pentium® D processors are listed in Table 2-3.

CPU Speed	Bus Speed	Mfg. Tech	Cache	Package	Processor No.
3.60 GHz	800 MHz	65 nm	4 MB	LGA775	960
3.40 GHz	800 MHz	65 nm	4 MB	LGA775	950
3.40 GHz	800 MHz	65 nm	4 MB	LGA775	945

Table 2-3: Supported Intel® Pentium® D Processors

2.4.5 Supported Intel® Celeron® D Processors

Specifications for the compatible Intel® Celeron® D processors are listed in Table 2-4 below:

CPU Speed	Bus Speed	Mfg. Tech	Cache	Package	Processor No.
3.60 GHz	533 MHz	65 nm	512 KB	LGA775	365
3.46 GHz	533 MHz	65 nm	512 KB	LGA775	360
3.33 GHz	533 MHz	65 nm	512 KB	LGA775	356

Table 2-4: Supported Intel® Celeron® D Processors

2.5 Intel® 945G Northbridge Chipset

2.5.1 Intel® 945G Overview

The Intel® 945G northbridge chipset consists of a graphics and memory controller hub (GMCH). The GMCH on the Intel® 945G is interfaced to the Intel® I/O Controller Hub 7 (ICH7) through a high speed Direct Media Interface (DMI) chip-to-chip connection. The high-speed DMI integrates priority based servicing that allows for concurrent traffic and true isochronous transfer capabilities. Some of the features of the Intel® 945G are listed below.

- Support 533/800/1066MHz FSB

- Supports four, 1GB, 400/533/667MHz dual channel DDR SDRAM DIMMs
- Integrated VGA and SDVO (Serial Digital Video Output) outputs
- Integrated Intel® Graphics Media Accelerator 950 (Intel® GMA 950)
- 2.0GB/s concurrent DMI bandwidth maximizes chipset communications
- PCI Express x16 Graphics Interface with a raw bit rate on data pins of 2Gb/s
- Integrated Intel® High Definition Audio
- Integrated Intel® Matrix Storage Technology
- Integrated Intel® Active Management Technology
- Integrated Intel® Flex Memory Technology

2.5.2 Intel® 945G Memory Support

The Intel® 945G supports four, 1GB, 400/533/667MHz dual channel DDR SDRAM DIMMs. Four 240-pin memory sockets on the IMBA-9454G enable a maximum of 4GB of memory to be installed on the system. The memory sockets are shown in Figure 2-4.

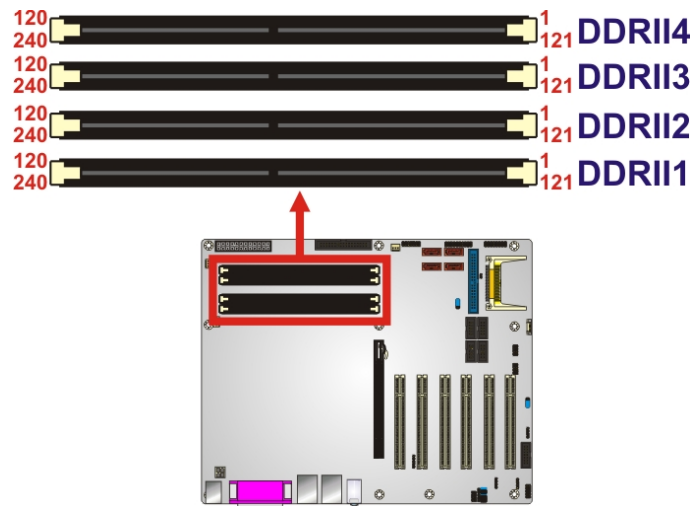

Figure 2-4: 240-pin DIMM Sockets

2.5.3 Intel® 945G Integrated Graphics Media Accelerator 950

The Intel® 945G has the Intel® GMA 950 integrated into the chipset. Some of the features of the GMA 950 are listed below.

- Intel GMA 950 Graphics Core
 - 400MHz 256-bit graphics core

IMBA-9454G Motherboard

- Up to 10.6 GB/sec memory bandwidth with DDR2 667 MHz system memory
- 1.6 GPixels/sec and 1.6 GTexels/sec fill rate
- 192 MB maximum video memory
- 2048x1536 at 75 Hz maximum resolution
- Dynamic Display Modes for flat-panel, wide-screen and Digital TV support
- Operating systems supported: Microsoft Windows* XP, Windows* XP 64-bit, Media Center Edition, Windows 2000; Linux-compatible (Xfree86 source available)
- High Performance 3D
 - Up to 4 pixels per clock rendering
 - Microsoft* DirectX* 9 Hardware Acceleration Features: Pixel Shader 2, Volumetric Textures, Shadow Maps, Slope Scale Depth Bias, Two-Sided Stencil
 - Microsoft* DirectX* 9 Vertex Shader 3.0 and Transform and Lighting supported in SW through highly optimized Processor Specific Geometry Pipeline (PSGP)
 - Texture Decompression for DirectX* and OpenGL*
 - OpenGL* 1.4 support with ARB extensions

2.6 Intel® ICH7 Southbridge Chipset

2.6.1 Intel® ICH7 Overview

The ICH7 southbridge chipset on the IMBA-9454G has the features listed below.

- Complies with PCI Express Base Specification, Revision 1.0a
- Complies with PCI Local Bus Specification, Revision 2.3 and supports 33MHz PCI operations
- Supports ACPI Power Management Logic
- Contains:
 - Enhanced DMA controller
 - Interrupt controller
 - Timer functions
- Integrated SATA host controller with DMA operations on four ports with data transfer rates up to 3.0 Gb/s

- Integrated IDE controller supports Ultra ATA 100/66/33
- Supports eight USB 2.0 devices with four UHCI controllers and one EHCI controller
- Complies with System Management Bus (SMBus) Specification, Version 2.0
- Supports Audio Codec '97 (AC'97) Revision 2.3
- Serial Peripheral Interface (SPI) for Serial and Shared Flash
- 1.05 V Core Voltage

2.6.2 Realtek ALC655 Audio Codec '97 Controller

The ALC655 complies with AC'97 Component Specification, Version 2.3. The ALC655 controller supports up to six PCM audio output channels. Complete surround sound requires six-channel audio consisting of:

- Front left
- Front right
- Back left
- Back right
- Center
- Subwoofer

2.6.3 Intel® ICH7 IDE Interface

The integrated IDE interface on the ICH7 southbridge supports two IDE hard disks and ATAPI devices, PIO IDE transfers up to 16MB/s and Ultra ATA transfers of 100MB/s. The integrated IDE interface is able to support the following IDE HDDs:

- **Ultra ATA/100**, with data transfer rates up to 100MB/s
- **Ultra ATA/66**, with data transfer rates up to 66MB/s
- **Ultra ATA/33**, with data transfer rates up to 33MB/s

Table 2-5 shows the supported HDD specifications.

Specification	Ultra ATA/100	Ultra ATA/66	Ultra ATA/33
IDE devices	2	2	2
PIO Mode	0 – 4	0 – 4	0 – 4

IMBA-9454G Motherboard

Specification	Ultra ATA/100	Ultra ATA/66	Ultra ATA/33
PIO Max Transfer Rate	16.6 MB/s	16.6 MB/s	16.6 MB/s
DMA/UDMA designation	UDMA 3 - 4	UDMA 3 – 4	UDMA 2
DMA/UDMA Max Transfer	100MB/s	66MB/s	33MB/s
Controller Interface	5V	5V	5V

Table 2-5: Supported HDD Specifications

2.6.4 Intel® ICH7 PCI Interface

The PCI interface on the ICH7 is compliant with the PCI Revision 2.3 implementation. Some of the features of the PCI interface are listed below.

- PCI Revision 2.3 compliant
- 33MHz
- 5V tolerant PCI signals (except PME#)
- Integrated PCI arbiter supports up to seven PCI bus masters

2.6.5 Intel® ICH7 Real Time Clock

256 bytes of battery backed RAM is provided by the Motorola MC146818A real time clock (RTC) integrated into the ICH7. The RTC operates on a 3V battery and 32.768KHz crystal. The RTC keeps track of the time and stores system data even when the system is turned off.

2.6.6 Intel® ICH7 SATA Controller

The integrated SATA controller on the ICH7 southbridge supports four SATA drives with independent DMA operations. SATA controller specifications are listed below.

- Supports four SATA drives
- Supports 3.0Gb/s data transfer speeds
- Supports Serial ATA Specification, Revision 1.0a and supports several optional sections of the Serial ATA II: Extensions to Serial ATA 1.0 Specification, Revision 1.0 (AHCI support is required for some elements).

2.6.7 Intel® ICH7 USB Controller

Up to eight high-speed, full-speed or low-speed USB devices are supported by the ICH7. High-speed USB 2.0, with data transfers of up to 480MB/s, is enabled with the ICH7 integrated Enhanced Host Controller Interface (EHCI) compliant host controller. USB full-speed and low-speed signaling is supported by the four ICH7 integrated Universal Host Controller Interface (UHCI) controller.

2.7 PCI Bus Components

2.7.1 PCI Bus Overview

The PCI bus controller on the ICH7 southbridge is compliant with PCI Revision 2.3 specifications and has a 33MHz PCI clock.

2.7.2 Realtek LAN interface

The Realtek RTL8111E is a 10/100/1000BASE-T Ethernet LAN controller. The RTL8111E combines a triple-speed IEEE 802.3 compliant Media Access Controller (MAC) with a triple-speed Ethernet transceiver, a PCIe bus interface, and an on-chip buffer memory. Some of the RTL8111E controller features are listed below:

- Integrated 10/100/1000BASE-T transceiver
- Automatic Negotiation with Next Page capability
- PCIe v1.1
- IEEE 802.3u and IEEE 802.3ab compliant
- Wake on LAN support meeting ACPI requirements
- Supports Alert Standard Format 2.0 (ASF2.0)
- One-Time-Programmable (OTP) memory
- Serial EEPROM

2.7.3 BIOS Chipset

The BIOS chipset has a licensed copy of AMI BIOS installed on the chipset. Some of the BIOS features are listed below:

- AMI Flash BIOS
- SMIBIOS (DMI) compliant

IMBA-9454G Motherboard

- Console redirection function support
- PXE (Pre-boot Execution Environment) support
- USB booting support

2.7.4 Super I/O chipset

The iTE IT8712F Super I/O chipset is connected to the ICH6 southbridge through the LPC bus. The iTE IT8712F is an LPC interface-based Super I/O device that comes with Environment Controller integration. Some of the features of the iTE IT8712F chipset are listed below:

- LPC Interface
- PC98/99/2001, ACPI and LANDesk Compliant
- Enhanced Hardware Monitor
- Fan Speed Controller
- SmartGuardian Controller
- Single +5V Power Supply
- Two 16C550 UARTs for serial port control
- One IEEE 1284 Parallel Port
- Floppy Disk Controller
- Keyboard Controller
- Watchdog Timer
- Serial IRQ Support
- Vbat & Vcch Support
- Single +5V Power Supply

Some of the Super I/O features are described in more detail below:

2.7.4.1 Super I/O LPC Interface

The LPC interface on the Super I/O complies with the Intel[®] Low Pin Count Specification Rev. 1.0. The LPC interface supports both LDRQ# and SERIRQ protocols as well as PCI PME# interfaces.

2.7.4.2 Super I/O 16C550 UARTs

The onboard Super I/O has two integrated 16C550 UARTs that can support the following:

- Two standard serial ports (COM1 and COM2)
- IrDa 1.0 and ASKIR protocols

Another two chipsets connected to the LPC bus provided connectivity to another two serial port connectors (COM3 and COM4).

2.7.4.3 Super I/O Enhanced Hardware Monitor

The Super I/O Enhanced Hardware Monitor monitors three thermal inputs, VBAT internally, and eight voltage monitor inputs. These hardware parameters are reported in the BIOS and can be read from the BIOS Hardware Health Configuration menu.

2.7.4.4 Super I/O Fan Speed Controller

The Super I/O fan speed controller enables the system to monitor the speed of the fan. One of the pins on the fan connector is reserved for fan speed detection and interfaced to the fan speed controller on the Super I/O. The fan speed is then reported in the BIOS.

2.7.4.5 Super I/O Parallel Port

The Super I/O parallel port (LPT) supports standard mode, enhanced mode and high-speed mode parallel port devices. The LPT is compliant with the following LPT modes.

- Standard mode
 - Bi-directional SPP compliant
- Enhanced mode
 - EPP v1.7 compliant
 - EPP v1.9 compliant
- High-speed mode
 - ECP, IEEE 1284 compliant

2.7.4.6 Super I/O Keyboard Controller

The Super I/O keyboard controller can execute the 8042 instruction set. Some of the keyboard controller features are listed below:

- The 8042 instruction is compatible with a PS/2 keyboard and PS/2 mouse

IMBA-9454G Motherboard

- Gate A20 and Keyboard reset output
- Supports multiple keyboard power on events
- Supports mouse double-click and/or mouse move power on events

2.8 Environmental and Power Specifications

2.8.1 System Monitoring

Three thermal inputs on the IMBA-9454G Super I/O Enhanced Hardware Monitor the following temperatures:

- System temperature
- Power temperature
- CPU temperature

Eight voltage inputs on the IMBA-9454G Super I/O Enhanced Hardware Monitor the following voltages:

- CPU Vcore
- DRAM Vcc
- +3.3V
- +5.0V
- +12.0V
- FSB Vcc
- +1.5V
- 3V Dual

The IMBA-9454G Super I/O Enhanced Hardware Monitor also monitors the following voltages internally:

- VBAT

The IMBA-9454G Super I/O Enhanced Hardware Monitor also monitors the following fan speeds:

- CPU Fan speed

The values for the above environmental parameters are all recorded in the BIOS Hardware Health Configuration menu.

2.8.2 Operating Temperature and Temperature Control

The maximum and minimum operating temperatures for the IMBA-9454G are listed below.

- Minimum Operating Temperature: 0°C (32°F)
- Maximum Operating Temperature: 60°C (140°F)

A cooling fan and heat sink must be installed on the CPU. Thermal paste must be smeared on the lower side of the heat sink before it is mounted on the CPU. Heat sinks are also mounted on the northbridge and southbridge chipsets to ensure the operating temperature of these chips remain low.

2.8.3 Power Consumption

Table 2-6 shows the power consumption parameters for the IMBA-9454G running with an Intel® Core™ 2 Duo E7400 2.8 GHz/1066 MHz CPU with 2 x 2GB DDR2 800 MHz memory.

Voltage	Current
+3.3V	6.24A
+5V	2.86A
+12V	0.39A

Table 2-6: Power Consumption

Chapter

3

Unpacking

IMBA-9454G Motherboard

3.1 Anti-static Precautions



WARNING:

Failure to take ESD precautions during the installation of the IMBA-9454G may result in permanent damage to the IMBA-9454G and severe injury to the user.

Electrostatic discharge (ESD) can cause serious damage to electronic components, including the IMBA-9454G. Dry climates are especially susceptible to ESD. It is critical that the following anti-static precautions are strictly adhered to whenever handling the IMBA-9454G or any other electrical component.

- ***Wear an anti-static wristband*** - Wearing a simple anti-static wristband can help to prevent ESD from damaging the IMBA-9454G.
- ***Self-grounding*** - Touch a grounded conducting material before handling and periodically while handling the IMBA-9454G.
- ***Use an anti-static pad*** - When configuring the IMBA-9454G, place it on an anti-static pad to reduce the possibility of ESD damage.
- ***Only handle the edges of the IMBA-9454G*** - When handling the IMBA-9454G, hold it by its edges.

3.2 Unpacking

3.2.1 Unpacking Precautions

When the IMBA-9454G is unpacked, please do the following:

- Follow the anti-static precautions outlined in **Section 3.1**.
- Make sure the packing box is facing upwards so the IMBA-9454G does not fall out of the box.
- Make sure all the components shown in **Section 3.3** are present.

3.3 Unpacking Checklist





NOTE:

If any components listed in the checklist below are missing, do not proceed with the installation. Contact the IEI reseller or vendor the IMBA-9454G was purchased from or contact an IEI sales representative directly by sending an email to sales@iei.com.tw.

3.3.1 Package Contents

The IMBA-9454G is shipped with the following components:

Quantity	Item and Part Number	Image
1	IMBA-9454G	
1	ATA 66/100 flat cable (P/N: 32200-000052-RS)	

IMBA-9454G Motherboard







Quantity	Item and Part Number	Image
2	Dual RS-232 cable (P/N: 19800-000113-RS)	
2	SATA cables (P/N: 32000-0628000-RS)	
1	SATA power cable (P/N: 32102-000100-100/200-RS)	
1	I/O Shielding (P/N: 45014-0017C0-00-RS)	
1	Mini jumper Pack (P/N: 33100-000079-RS)	
1	Quick Installation Guide (P/N: 51000-001083-RS)	
1	Utility CD (P/N: IEI-7B000-000096-RS)	

Table 3-1: Package List Contents

3.3.2 Optional Components

The following optional components are available from IEI.

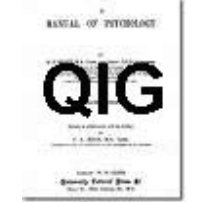
Item and Part Number	Image
CPU cooling kit (P/N: CF-520-RS)	
CPU cooling kit (P/N: CF-775A-RS)	
FDD cable (P/N: 32200-0000-17-RS)	
RS-232/422/485 cable (P/N: 32200-000063-RS)	
VGA output SDVO card (P/N: SVDO-100VGA-R10)	
DVI output SDVO card (P/N: SVDO-100DVI-R10)	
Infineon TPM module (P/N: TPM-IN01-R11)	
Dual USB cable (P/N: CB-USB02-RS)	
Four USB cable (P/N: CB-USB04-RS)	

Table 3-2: Optional Components

Chapter

4

Connector Pinouts

IMBA-9454G Motherboard

4.1 Peripheral Interface Connectors

Section 4.1.1 shows peripheral interface connector locations. **Section 4.1.2** lists all the peripheral interface connectors seen in **Section 4.1.1**.

4.1.1 IMBA-9454G Layout

Figure 4-1 shows the on-board peripheral connectors, rear panel peripheral connectors and on-board jumpers.

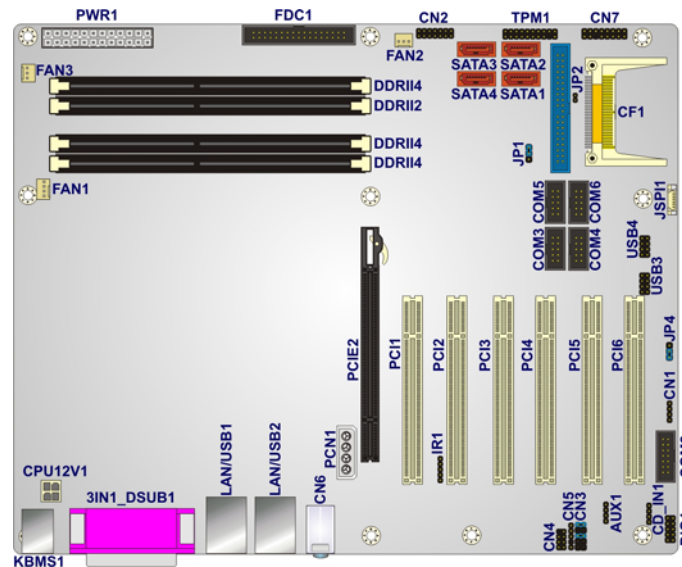

Figure 4-1: Connector and Jumper Locations

4.1.2 Peripheral Interface Connectors

Table 4-1 shows a list of the peripheral interface connectors on the IMBA-9454G. Detailed descriptions of these connectors can be found below.

Connector	Type	Label
+12V ATX power connector	4-pin header	CPU12V1
ATX power connector	24-pin header	PWR1
Audio connector	7-pin header	CN4
Auxiliary audio connector	4-pin header	AUX1
CD-in connector	4-pin header	CD_IN1

Connector	Type	Label
CompactFlash connector	50-pin CF slot	CF1
Digital input/output connector	10-pin header	DIO1
Fan connector - CPU	4-pin wafer	FAN1
Fan connector - System	3-pin wafer	FAN2
Fan connector - System	3-pin wafer	FAN3
Floppy disk drive connector	34-pin box header	FDC1
Front panel audio connector	10-pin header	CN3
IDE Interface connector	40-pin box header	IDE1
Infrared connector	5-pin header	IR1
Multi-panel connector	14-pin header	CN2
PCI Express x16 slot	82-pin PCIe x16 slot	PCIE2
PCI Express power connector	4-pin wafer	PCN1
PCI slot	124-pin PCI slot	PCI1
PCI slot	124-pin PCI slot	PCI2
PCI slot	124-pin PCI slot	PCI3
PCI slot	124-pin PCI slot	PCI4
PCI slot	124-pin PCI slot	PCI5
PCI slot	124-pin PCI slot	PCI6
SATA drive connector	7-pin SATA	SATA1
SATA drive connector	7-pin SATA	SATA2
SATA drive connector	7-pin SATA	SATA3
SATA drive connector	7-pin SATA	SATA4
Serial port connector (RS-232)	10-pin box header	COM3
Serial port connector (RS-232)	10-pin box header	COM4
Serial port connector (RS-232)	10-pin box header	COM5
Serial port connector (RS-232)	10-pin box header	COM6
Serial port connector (RS-232/422/485)	14-pin header	COM2

IMBA-9454G Motherboard

Connector	Type	Label
Serial port connector (RS-422/485)	4-pin header	CN1
SPDIF connector	5-pin header	CN5
TPM connector	20-pin header	TPM1
USB connector	8-pin header	USB3
USB connector	8-pin header	USB4

Table 4-1: Peripheral Interface Connectors

4.1.3 External Peripheral Interface Panel Connectors

Table 4-2 lists the external peripheral interface panel connectors on the IMBA-9454G. Detailed descriptions of these connectors can be found in.

Connector	Type	Label
Keyboard/Mouse	PS/2	KBMS1
Parallel port connector	DB-25 (female)	3IN1_DSUB1A
Ethernet/USB connector	RJ-45/USB port combo connector	LAN/USB1B
Ethernet/USB connector	RJ-45/USB port combo connector	LAN/USB2B
Audio connector	3 x Audio jacks	CN6
VGA connector	DB-15 (female)	3IN1_DSUB1C
Serial connector	DB-9 (male)	3IN1_DSUB1B

Table 4-2: External Peripheral Interface Panel Connectors

4.2 Internal Peripheral Connectors

Internal peripheral connectors are found on the motherboard and are only accessible when the motherboard is outside of the chassis. This section has complete descriptions of all the internal, peripheral connectors on the IMBA-9454G.

4.2.1 ATX Power Supply Connector (4-pins)

CN Label: CPU12V1

CN Type: 4-pin ATX power connector (1x4)

CN Location: See Figure 4-2

CN Pinouts: See Table 4-3

The 4-pin ATX power supply connector is connected to a +12V ATX power supply.

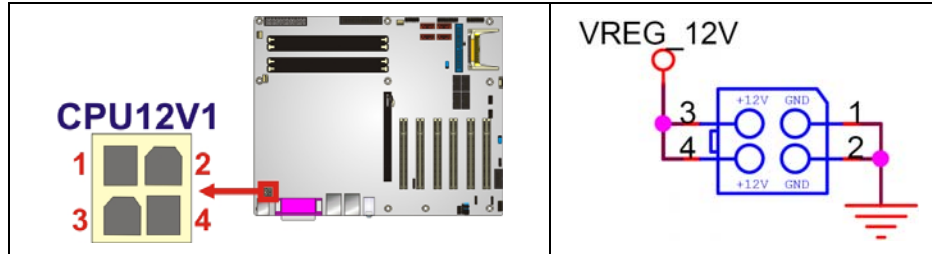

Figure 4-2: ATX Power Supply Connector (4-pins) Location

PIN	DESCRIPTION
1	GND
2	GND
3	+12V
4	+12V

Table 4-3: ATX Power Supply Connector (4-pins) Pinouts

4.2.2 ATX Power Supply Connector (24-pins)

CN Label: PWR1

CN Type: 24-pin ATX power connector (2x12)

CN Location: See Figure 4-3

CN Pinouts: See Table 4-4

The 24-pin ATX power supply connector is connected to a ATX power supply.

IMBA-9454G Motherboard

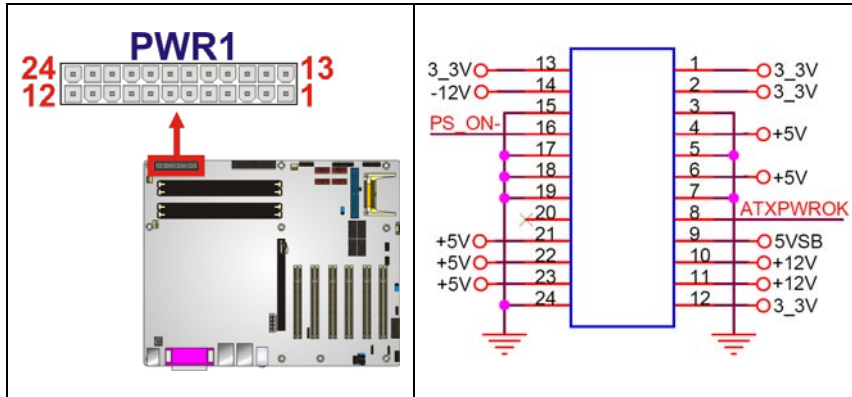

Figure 4-3: ATX Power Connector Location

PIN	DESCRIPTION	PIN	DESCRIPTION
1	3.3V01	13	3.3V04
2	3.3V02	14	-12V
3	COM01	15	COM
4	+5V01	16	PS-ON
5	COM02	17	COM04
6	+5V02	18	COM05
7	COM03	19	COM06
8	PWR-OK	20	-5V
9	5VSB	21	+5V03
10	+12V01	22	+5V04
11	+12V02	23	+5V05
12	3.3V03	24	COM07

Table 4-4: ATX Power Connector Pinouts

4.2.3 Audio Connector (8-pin)

- CN Label:** CN4
- CN Type:** 7-pin header
- CN Location:** See
- CN Pinouts:** See Table 4-5

The 8-pin audio connector is connected to external audio devices including speakers and microphones for the input and output of audio signals to and from the system.

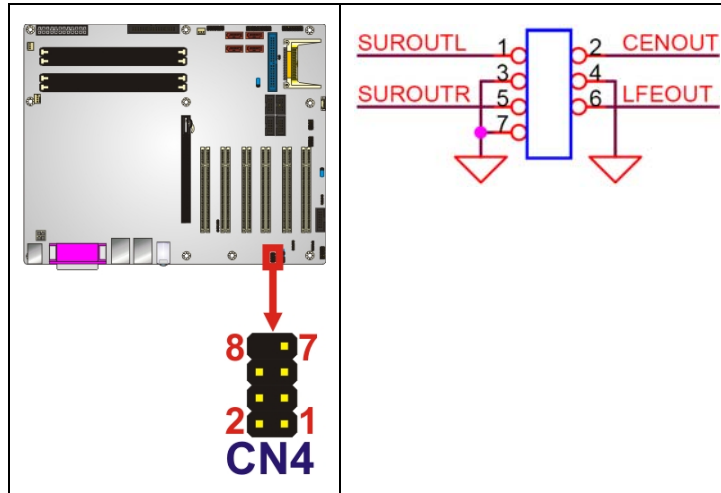

Figure 4-4: Audio Connector Location (8-pin)

PIN	DESCRIPTION	PIN	DESCRIPTION
1	SUROUTL	2	CENOUT
3	GND	4	GND
5	SUROUTL	6	LFEOUT
7	GND		

Table 4-5: Audio Connector Pinouts (8-pin)

4.2.4 Auxiliary Audio Connector (4-pin)

- CN Label:** AUX1
- CN Type:** 4-pin header
- CN Location:** See Figure 4-5
- CN Pinouts:** See Table 4-6

The 4-pin auxiliary audio connector provides a second audio input to the system.

IMBA-9454G Motherboard

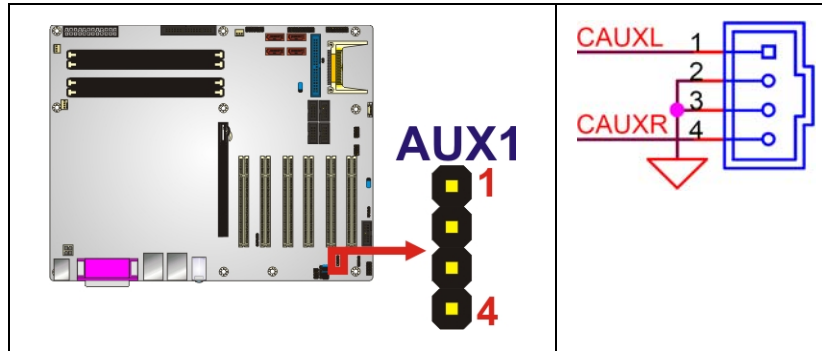

Figure 4-5: Auxiliary Audio Connector Location (4-pin)

PIN	DESCRIPTION
1	CAUXL
2	GND
3	GND
4	CAUXR

Table 4-6: Auxiliary Audio Connector Pinouts (4-pin)

4.2.5 CD-In Connector

CN Label: CD_IN1

CN Type: 4-pin header

CN Location: See Figure 4-6

CN Pinouts: See Table 4-7

The 4-pin CD-in connector connects a CD to the system.

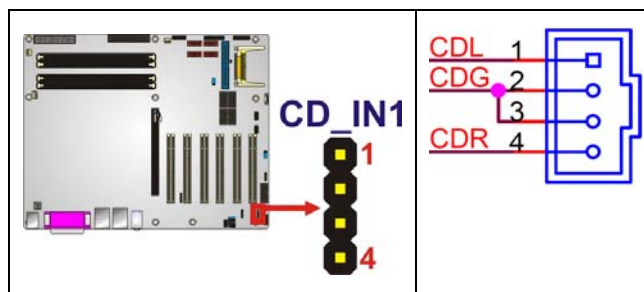

Figure 4-6: CD-In Connector

PIN	DESCRIPTION
-----	-------------

1	CDL
2	GND
3	GND
4	CDR

Table 4-7: CD-In Connector

4.2.6 Compact Flash Socket

- CN Label:** CF1
- CN Type:** 50-pin header (2x25)
- CN Location:** See **Figure 4-7**
- CN Pinouts:** See **Table 4-8**

A CF Type I or Type II memory card inserts into the CF socket on the motherboard.

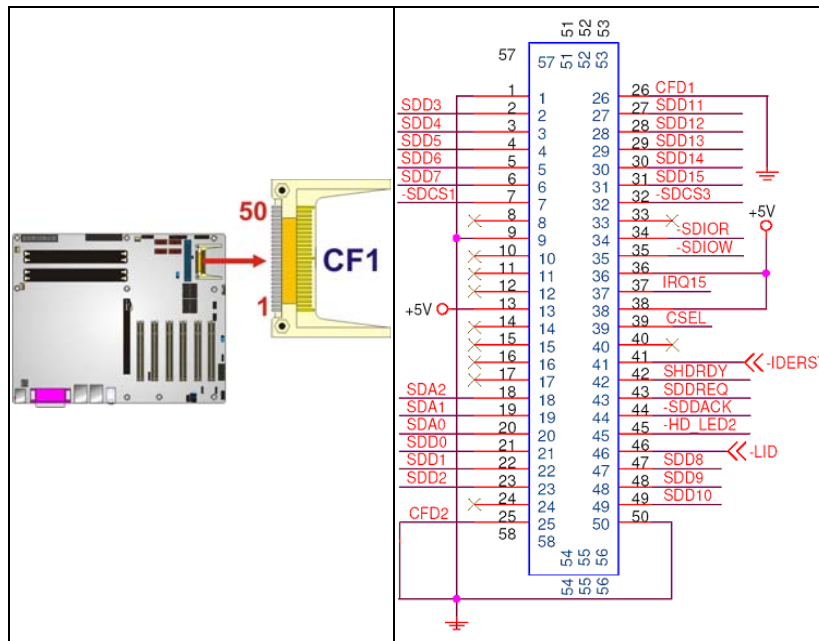
Figure 4-7: CF Card Socket Location

PIN	DESCRIPTION	PIN	DESCRIPTION
1	GROUND	26	VCC-IN CHECK1
2	DATA 3	27	DATA 11

IMBA-9454G Motherboard

PIN	DESCRIPTION	PIN	DESCRIPTION
3	DATA 4	28	DATA 12
4	DATA 5	29	DATA 13
5	DATA 6	30	DATA 14
6	DATA 7	31	DATA 15
7	HDC_CS0#	32	HDC_CS1
8	N/C	33	N/C
9	GROUND	34	IOR#
10	N/C	35	IOW#
11	N/C	36	VCC_COM
12	N/C	37	IRQ15
13	VCC_COM	38	VCC_COM
14	N/C	39	CSEL
15	N/C	40	N/C
16	N/C	41	HDD_RESET
17	N/C	42	IORDY
18	SA2	43	SDREQ
19	SA1	44	SDACK#
20	SA0	45	HDD_ACTIVE#
21	DATA 0	46	66DET
22	DATA 1	47	DATA 8
23	DATA 2	48	DATA 9
24	N/C	49	DATA 10
25	VCC-IN CHECK2	50	GROUND

Table 4-8: CF Card Socket Pinouts

4.2.7 Digital Input/Output (DIO) Connector

CN Label: DIO1

CN Type: 10-pin header (2x5)

CN Location: See Figure 4-8

CN Pinouts: See Error! Reference source not found.

The digital input/output connector is managed through a Super I/O chip. The DIO connector pins are user programmable.

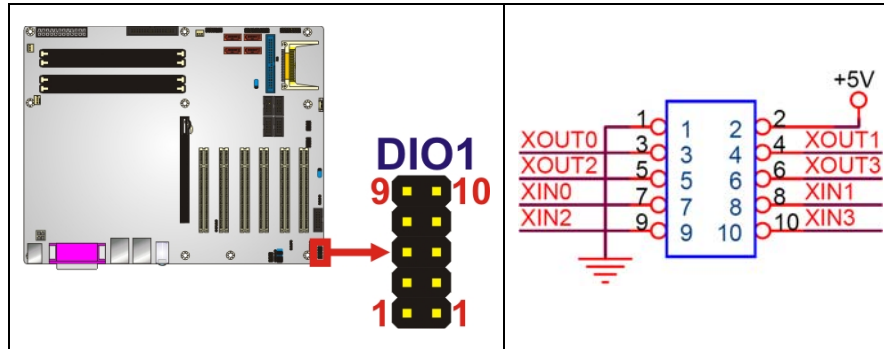

Figure 4-8: DIO Connector Locations

PIN	DESCRIPTION	PIN	DESCRIPTION
1	GND	2	PWR (+5V)
3	XOUT0	4	XOUT1
5	XOUT2	6	XOUT3
7	XIN0	8	XIN1
9	XIN2	10	XIN3

Table 4-9: DIO Connector Pinouts

4.2.8 Fan Connectors

- CN Label:** FAN1, FAN2, FAN3
- CN Type:** FAN1: 4-pin wafer connector
FAN1, FAN2: 3-pin wafer connector
- CN Location:** See Figure 4-9
- CN Pinouts:** See Error! Reference source not found.

The FAN1, FAN2 and FAN3 cooling fan connectors provide a 12V current to the cooling fans. The connector has a "rotation" pin to get rotation signals from the fan and notify the system so the system BIOS can recognize the fan speed. Please note that only certain fans can issue the rotation signals.

IMBA-9454G Motherboard

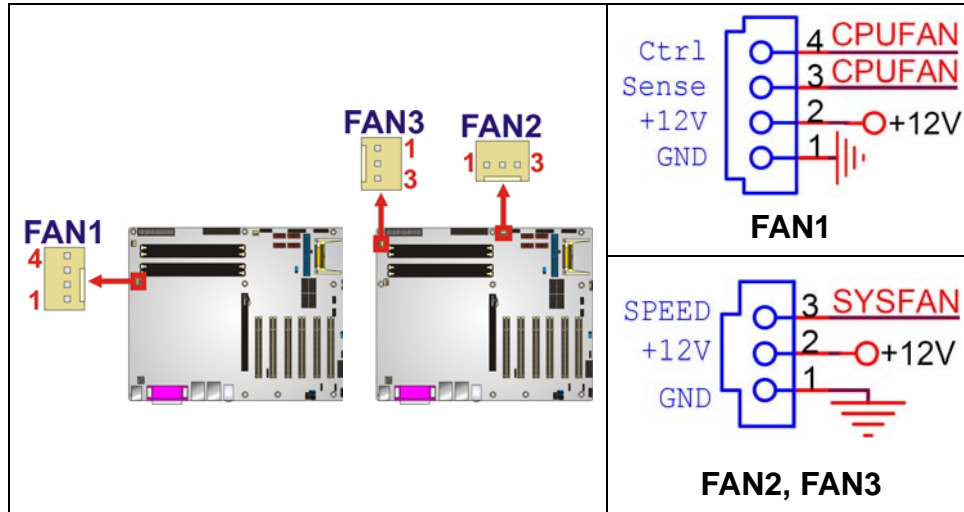

Figure 4-9: Fan Connectors Locations

PIN	FAN1	FAN2, FAN3
1	GND	GND
2	+12V	+12V
3	Rotation Signal	Rotation Signal
4	Control	

Table 4-10: Fan Connectors Pinouts

4.2.9 Floppy Disk Connector

- CN Label:** FDC1
- CN Type:** 34-pin header (2x17)
- CN Location:** See Figure 4-10
- CN Pinouts:** See Table 4-11

The floppy disk connector is connected to a floppy disk drive.

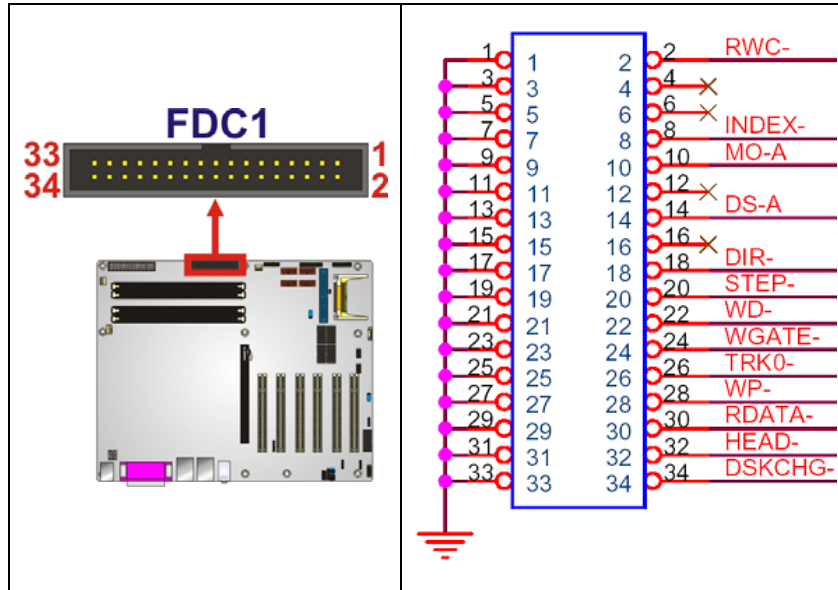

Figure 4-10: FDC Connector Location

PIN	DESCRIPTION	PIN	DESCRIPTION
1	GND	2	REDUCE WRITE
3	GND	4	N/C
5	N/C	6	N/C
7	GND	8	INDEX#
9	GND	10	MOTOR ENABLE A#
11	GND	12	DRIVE SELECT B#
13	GND	14	DRIVE SELECT A#
15	GND	16	MOTOR ENABLE B#
17	GND	18	DIRECTION#
19	GND	20	STEP#
21	GND	22	WRITE DATA#
23	GND	24	WRITE GATE#
25	GND	26	TRACK 0#
27	GND	28	WRITE PROTECT#
29	GND	30	READ DATA#
31	GND	32	SIDE 1 SELECT#
33	GND	34	DISK CHANGE#

Table 4-11: FDC Connector Pinouts

IMBA-9454G Motherboard

4.2.10 Front Panel Audio Connector

- CN Label:** CN3
- CN Type:** 10-pin header (2x6)
- CN Location:** See Figure 4-11
- CN Pinouts:** See Table 4-12

The front panel audio connector connects to external audio devices via a system's front panel audio interfaces.

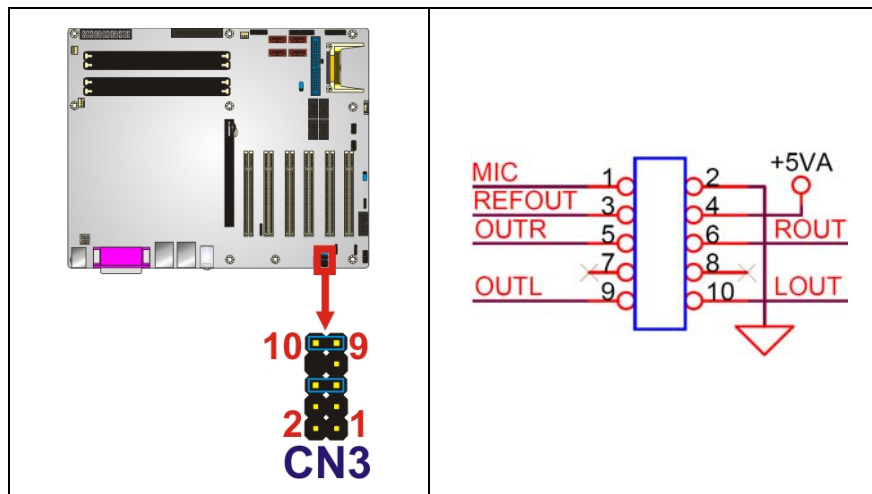

Figure 4-11: Front Panel Connector Pinout Locations

PIN	DESCRIPTION	PIN	DESCRIPTION
1	MIC IN	2	GND AUDIO
3	MIC BIAS	4	5V
5	LINE OUT (R)	6	LINE OUT (R) Return
7	NC	8	NC
9	LINE OUT (L)	10	LINE OUT (L) Return

Table 4-12: Front Panel Connector Pinouts

4.2.11 IDE Connector (40-pin)

- CN Label:** IDE1

CN Type: 40-pin box header (2x20)

CN Location: See Figure 4-12

CN Pinouts: See Table 4-13

One 40-pin IDE device connector on the IMBA-9454G supports connectivity to two hard disk drives.

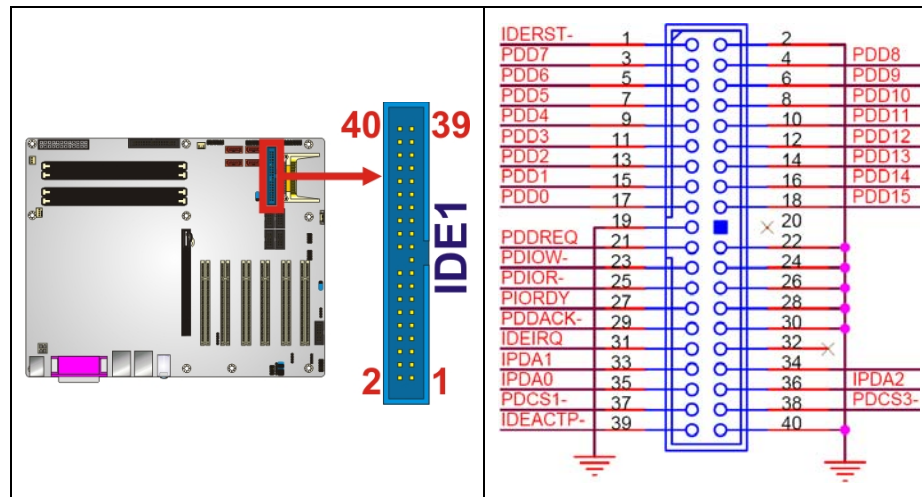

Figure 4-12: IDE Device Connector Locations

PIN	DESCRIPTION	PIN	DESCRIPTION
1	RESET#	2	GROUND
3	DATA 7	4	DATA 8
5	DATA 6	6	DATA 9
7	DATA 5	8	DATA 10
9	DATA 4	10	DATA 11
11	DATA 3	12	DATA 12
13	DATA 2	14	DATA 13
15	DATA 1	16	DATA 14
17	DATA 0	18	DATA 15
19	GROUND	20	N/C
21	IDE DRQ	22	GROUND
23	IOW#	24	GROUND
25	IOR#	26	GROUND

IMBA-9454G Motherboard

PIN	DESCRIPTION	PIN	DESCRIPTION
27	IDE CHRDY	28	GROUND
29	IDE DACK	30	GROUND-DEFAULT
31	INTERRUPT	32	N/C
33	SA1	34	N/C
35	SA0	36	SA2
37	HDC CS0#	38	HDC CS1#
39	HDD ACTIVE#	40	GROUND

Table 4-13: IDE Connector Pinouts

4.2.12 Infrared Interface Connector (5-pin)

- CN Label:** IR1
- CN Type:** 5-pin header (1x5)
- CN Location:** See Figure 4-13
- CN Pinouts:** See Table 4-14

The infrared interface connector supports both Serial Infrared (SIR) and Amplitude Shift Key Infrared (ASKIR) interfaces.

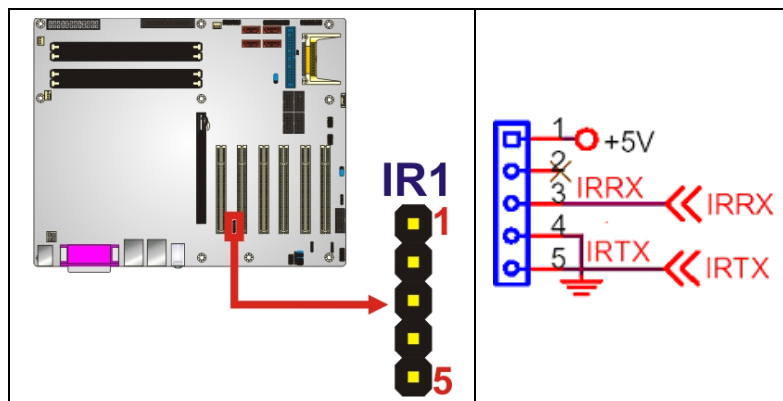

Figure 4-13: Infrared Connector Pinout Locations

PIN	DESCRIPTION
1	VCC
2	NC

3	IR-RX
4	GND
5	IR-TX

Table 4-14: Infrared Connector Pinouts

4.2.13 Multi-panel Connector

- CN Label:** CN2
- CN Type:** 14-pin header (2x7)
- CN Location:** See Figure 4-14
- CN Pinouts:** See Error! Reference source not found.

The multi-panel connector connects to external switches and indicators to monitor and controls the motherboard. These indicators and switches include:

- Power button
- Reset button
- Power LED
- HDD LED
- PC speaker

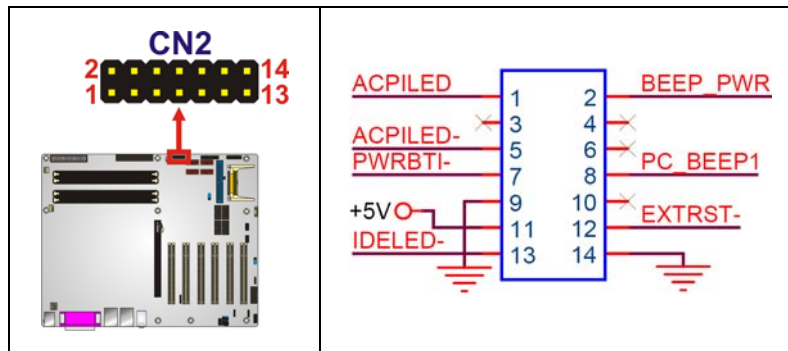
Figure 4-14: Multi-panel Connector Location

PIN	DESCRIPTION	PIN	DESCRIPTION
1	ACPILED+	2	SPEAKER+
3	N/C	4	N/C
5	ACPILED-	6	N/C
7	ATX POWER BUTTON	8	SPEAKER-

IMBA-9454G Motherboard

9	GND	10	N/C
11	IDE LED+	12	RESET SW
13	IDE LED -	14	GND

Table 4-15: Multi-panel Connector Pinouts

4.2.14 PCI Express x16 Slot

- CN Label:** PCIE2
- CN Type:** 82-pin PCIe x16 slot
- CN Location:** See Figure 4-15
- CN Pinouts:** See **Table 4-16 (Side A)** **Table 4-17 (Side B)**

PCIe x16 expansion devices can be inserted into the PCIe x16 slot.

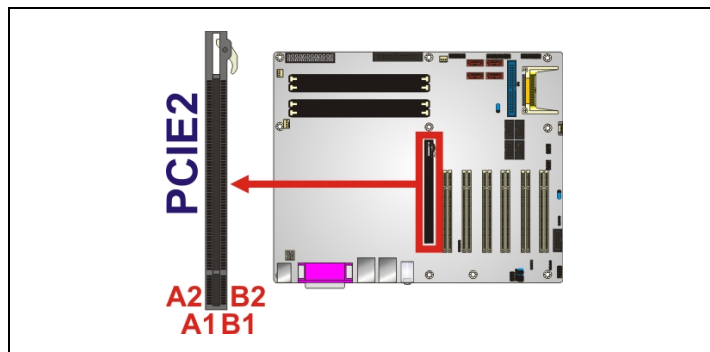

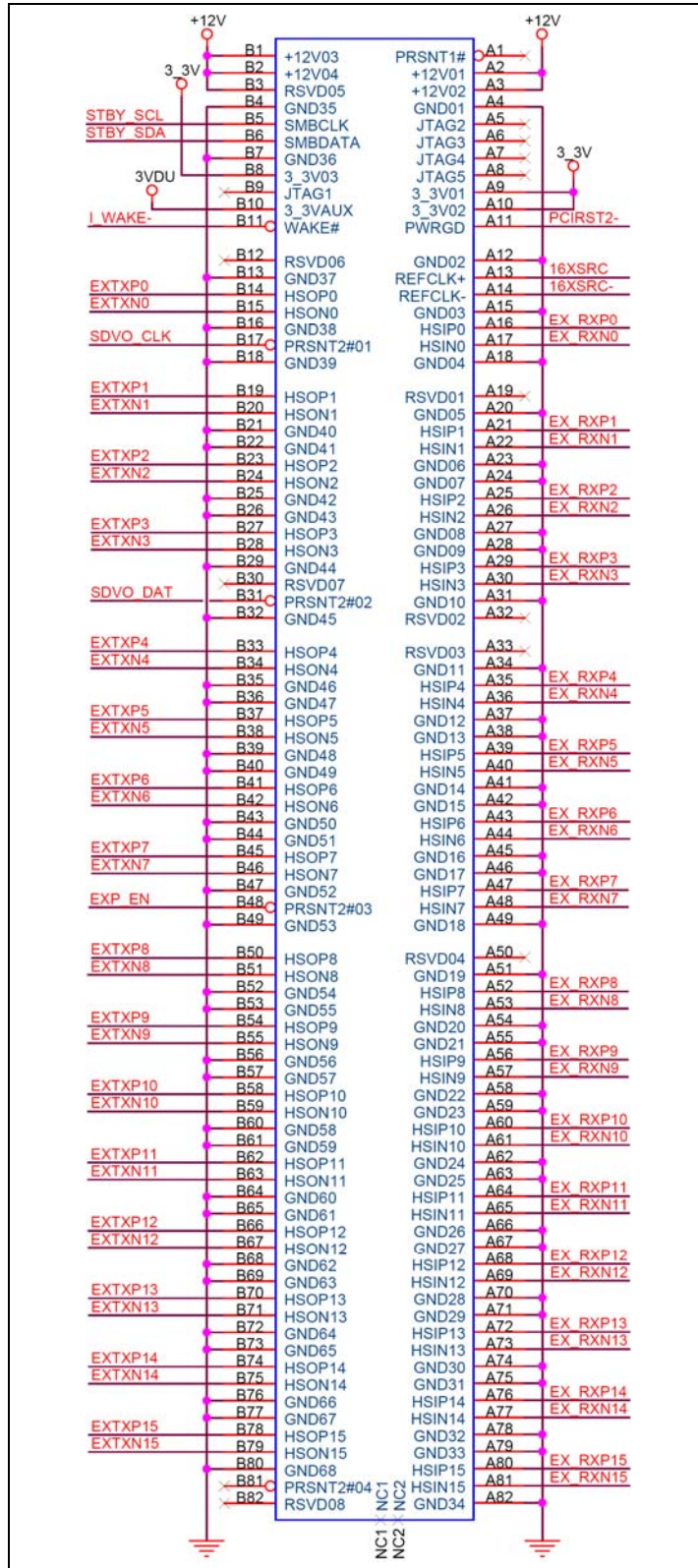

Figure 4-15: PCI Express x16 Slot Connector Location

IMBA-9454G Motherboard

PIN	NAME	PIN	NAME	PIN	NAME	PIN	NAME
A1	Name	A22	HSIn(1)	A43	HSIp(6)	A64	HSIp(11)
A2	PRSNT#1	A23	GND	A44	HSIn(6)	A65	HSIn(11)
A3	+12v	A24	GND	A45	GND	A66	GND
A4	+12v	A25	HSIp(2)	A46	GND	A67	GND
A5	GND	A26	HSIn(2)	A47	HSIp(7)	A68	HSIp(12)
A6	JTAG2	A27	GND	A48	HSIn(7)	A69	HSIn(12)
A7	JTAG3	A28	GND	A49	GND	A70	GND
A8	JTAG4	A29	HSIp(3)	A50	RSVD	A71	GND
A9	JTAG5	A30	HSIn(3)	A51	GND	A72	HSIp(13)
A10	+3.3v	A31	GND	A52	HSIp(8)	A73	HSIn(13)
A11	+3.3v	A32	RSVD	A53	HSIn(8)	A74	GND
A12	PWRGD	A33	RSVD	A54	GND	A75	GND
A13	GND	A34	GND	A55	GND	A76	HSIp(14)
A14	REFCLK+	A35	HSIp(4)	A56	HSIp(9)	A77	HSIn(14)
A15	REFCLK-	A36	HSIn(4)	A57	HSIn(9)	A78	GND
A16	GND	A37	GND	A58	GND	A79	GND
A17	HSIp(0)	A38	GND	A59	GND	A80	HSIp(15)
A18	HSIn(0)	A39	HSIp(5)	A60	HSIp(10)	A81	HSIn(15)
A19	GND	A40	HSIn(5)	A61	HSIn(10)	A82	GND
A20	RSVD	A41	GND	A62	GND		
A21	GND	A42	GND	A63	GND		

Table 4-16: PCIe x16 Side A Pinouts

PIN	NAME	PIN	NAME	PIN	NAME	PIN	NAME
B1	+12v	B22	GND	B43	GND	B64	GND
B2	+12v	B23	HSOp(2)	B44	GND	B65	GND
B3	RSVD	B24	HSOn(2)	B45	HSOp(7)	B66	HSOp(12)
B4	GND	B25	GND	B46	HSOn(7)	B67	HSOn(12)
B5	SMCLK	B26	GND	B47	GND	B68	GND
B6	SMDAT	B27	HSOp(3)	B48	PRSNT#2	B69	GND
B7	GND	B28	HSOn(3)	B49	GND	B70	HSOp(13)
B8	+3.3v	B29	GND	B50	HSOp(8)	B71	HSOn(13)
B9	JTAG1	B30	RSVD	B51	HSOn(8)	B72	GND
B10	3.3Vaux	B31	PRSNT#2	B52	GND	B73	GND
B11	WAKE#	B32	GND	B53	GND	B74	HSOp(14)
B12	RSVD	B33	HSOp(4)	B54	HSOp(9)	B75	HSOn(14)
B13	GND	B34	HSOn(4)	B55	HSOn(9)	B76	GND
B14	HSOp(0)	B35	GND	B56	GND	B77	GND
B15	HSOn(0)	B36	GND	B57	GND	B78	HSOp(15)
B16	GND	B37	HSOp(5)	B58	HSOp(10)	B79	HSOn(15)
B17	PRSNT#2	B38	HSOn(5)	B59	HSOn(10)	B80	GND
B18	GND	B39	GND	B60	GND	B81	PRSNT#2
B19	HSOp(1)	B40	GND	B61	GND	B82	RSVD#2
B20	HSOn(1)	B41	HSOp(6)	B62	HSOp(11)		
B21	GND	B42	HSOn(6)	B63	HSOn(11)		

Table 4-17: PCIe x16 Side B Pinouts

4.2.15 PCI Express Power Connector (4-pin)

- CN Label:** PCN1
- CN Type:** 4-pin wafer (1x4)
- CN Location:** See Figure 4-16
- CN Pinouts:** See Table 4-18

The PCI Express power connector provides 12V power to PCIe expansion cards.

IMBA-9454G Motherboard

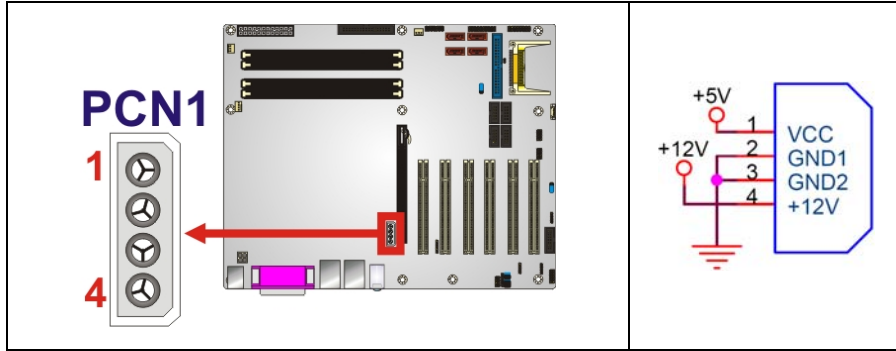

Figure 4-16: PCI Express Power Connector Pinout Locations

PIN	DESCRIPTION
1	VCC
2	GND
3	GND
4	+12V

Table 4-18: PCI Express Power Connector Pinouts

4.2.16 PCI Slot

CN Label: PC11 to PC16

CN Type: PCI Slot

CN Location: See

CN Pinouts: See Table 4-19

The PCI slot enables a PCI expansion module to be connected to the board.

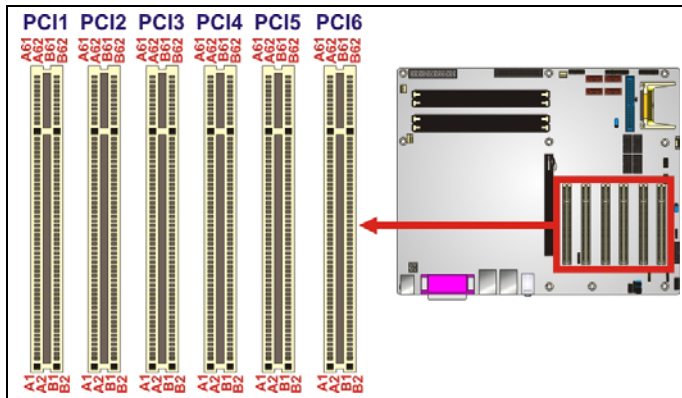

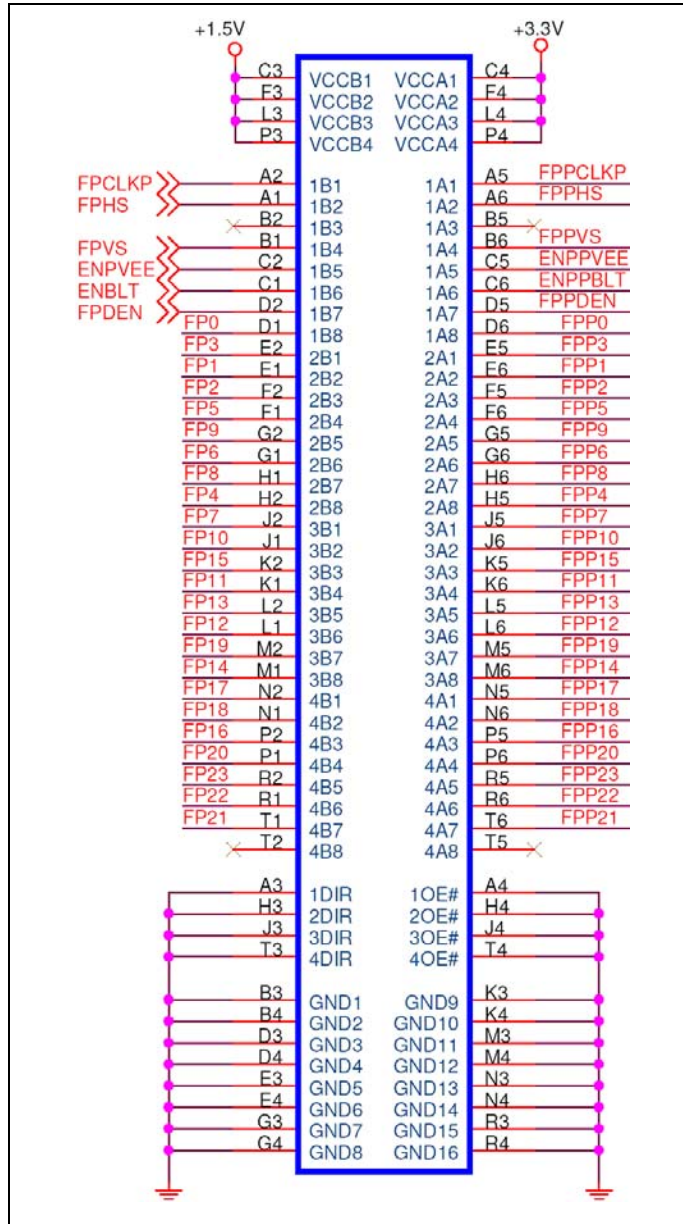
Figure 4-17: PCI Slot Location

PIN	DESCRIPTION	PIN	DESCRIPTION
A1	TRST	B1	-12V
A2	+12V	B2	TCK
A3	TMS	B3	GND
A4	TDI	B4	TDO
A5	+5V	B5	+5V
A6	INTA	B6	+5V

IMBA-9454G Motherboard

PIN	DESCRIPTION	PIN	DESCRIPTION
A7	INTC	B7	INTB
A8	+5V	B8	INTD
A9	RESERVED3	B9	PRSNT1
A10	+5V	B10	RESERVED1
A11	RESERVED4	B11	PRSNT2
A12	GND	B12	GND
A13	GND	B13	GND
A14	3.3V_AUX	B14	RESERVED2
A15	RST	B15	GND
A16	+5V	B16	CLK
A17	GNT	B17	GND
A18	GND	B18	REQ
A19	PME	B19	+5V
A20	AD30	B20	AD31
A21	+3.3V	B21	AD29
A22	AD28	B22	GND
A23	AD26	B23	AD27
A24	GND	B24	AD25
A25	AD24	B25	+3.3V
A26	IDSEL	B26	C/BE3
A27	+3.3V	B27	AD23
A28	AD22	B28	GND
A29	AD20	B29	AD21
A30	GND	B30	AD19
A31	AD18	B31	+3.3V
A32	AD16	B32	AD17
A33	+3.3V	B33	C/BE2
A34	FRAME	B34	GND
A35	GND	B35	IRDY
A36	TRDY	B36	+3.3V
A37	GND	B37	DEVSEL
A38	STOP	B38	GND

PIN	DESCRIPTION	PIN	DESCRIPTION
A39	+3.3V	B39	LOCK
A40	SDONE	B40	PERR
A41	SBO	B41	+3.3V
A42	GND	B42	SERR
A43	PAR	B43	+3.3V
A44	AD15	B44	C/BE1
A45	+3.3V	B45	AD14
A46	AD13	B46	GND
A47	AD11	B47	AD12
A48	GND	B48	AD10
A49	AD9	B49	GND
A52	C/BE0	B52	AD8
A53	+3.3V	B53	AD7
A54	AD6	B54	+3.3V
A55	AD4	B55	AD5
A56	GND	B56	AD3
A57	AD2	B57	GND
A68	AD0	B68	AD1
A59	+5V	B59	+5V
A60	REQ64	B60	ACK64
A61	+5V	B61	+5V
A62	+5V	B62	+5V

Table 4-19: PCI Slot

4.2.17 SATA Drive Connectors

CN Label: SATA1, SATA2, SATA3 and SATA4

CN Type: 7-pin SATA drive connectors

CN Location: See Figure 4-18

CN Pinouts: See Table 4-20

IMBA-9454G Motherboard

The SATA drive connectors are connected to SATA 3Gb/s disk drives that transfer data at speeds as high as 3.0Gb/s.

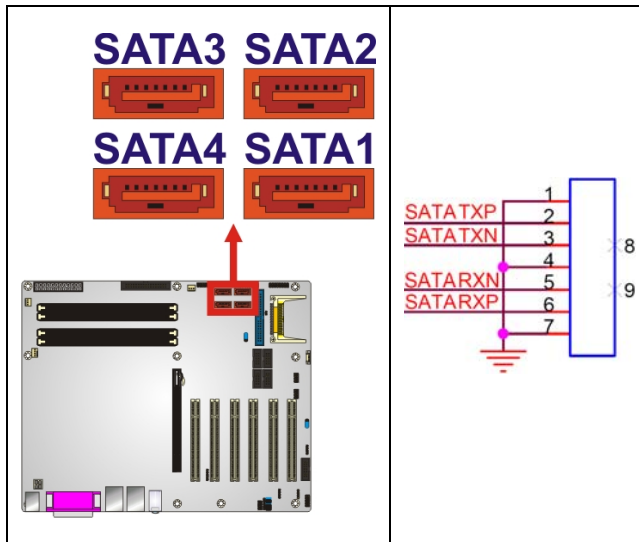

Figure 4-18: SATA Drive Connector Locations

PIN	DESCRIPTION
1	GND
2	TX+
3	TX-
4	GND
5	RX-
6	RX+
7	GND

Table 4-20: SATA Drive Connector Pinouts

4.2.18 Serial Port Connector (RS-232)

- CN Label:** COM3 to COM6
- CN Type:** 10-pin box header (2x5)
- CN Location:** See Figure 4-19
- CN Pinouts:** See Table 4-21

The 10-pin serial port connectors provide RS-232 serial communications channels that can be connected to external RS-232 serial port devices.

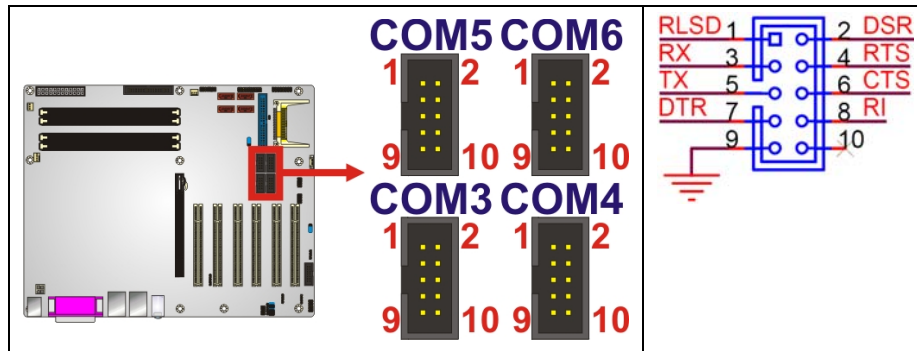

Figure 4-19: Serial Port Connector (RS-232) Pinout Locations

PIN	DESCRIPTION	PIN	DESCRIPTION
1	DCD-	6	DSR-
2	SIN	7	RTS-
3	SOUT	8	CTS-
4	DTR-	9	RI
5	GND	10	GND

Table 4-21: Serial Port Connector (RS-232) Pinouts

4.2.19 Serial Port Connector (RS-232/422/485)

- CN Label:** COM2
- CN Type:** 14-pin header (2x7)
- CN Location:** See Figure 4-20
- CN Pinouts:** See Table 4-22

The 14-pin serial port connector provides an RS-232/422/485 serial communications channel that can be connected to external RS-232/422/485 serial port devices. The signal type is controlled via the JP4 jumper and is shared with the CN1 connector.

IMBA-9454G Motherboard

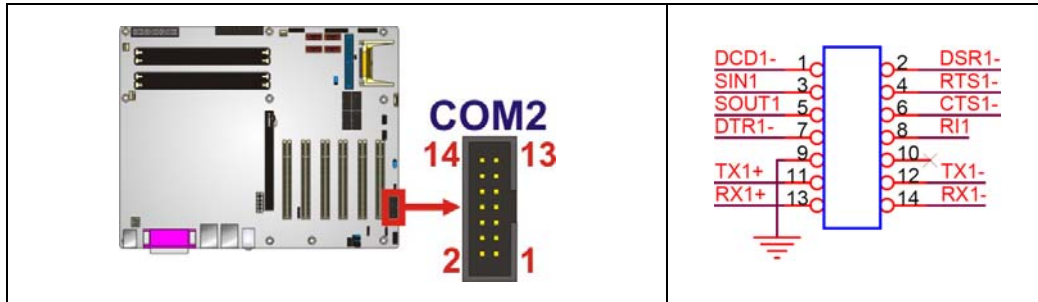

Figure 4-20: Serial Port Connector (RS-232/422/485) Pinout Locations

PIN	DESCRIPTION	PIN	DESCRIPTION
1	DCD	2	DSR
3	RXD	4	RTS
5	TXD	6	CTX
7	DTR	8	RI
9	GND	10	NC
11	TXD1+	12	TXD1-
13	RXD1+	14	RXD1-

Table 4-22: Serial Port Connector (RS-232/422/485) Pinouts

4.2.20 Serial Port Connector (RS-422/485)

- CN Label:** CN1
- CN Type:** 4-pin header
- CN Location:** See Figure 4-21
- CN Pinouts:** See Table 4-23

The 4-pin serial port connector provides RS-422/485 serial communications channels that can be connected to external RS-422/485 serial port devices. The port is shared with the COM2 port.

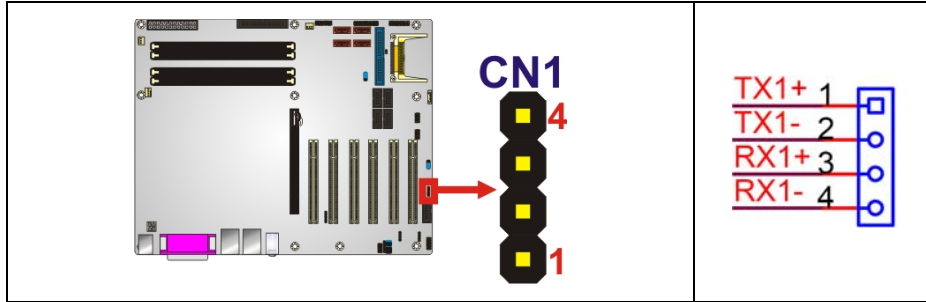

Figure 4-21: Serial Port Connector (RS-422/485) Pinout Locations

PIN	DESCRIPTION
1	TXD1+
2	TXD1-
3	RXD1+
4	RXD1-

Table 4-23: Serial Port Connector (RS-422/485) Pinouts

4.2.21 SPDIF Connector

- CN Label:** CN5
- CN Type:** 5-pin header
- CN Location:** See Figure 4-22
- CN Pinouts:** See Error! Reference source not found.

Use the SPDIF connector to connect digital audio devices to the system.

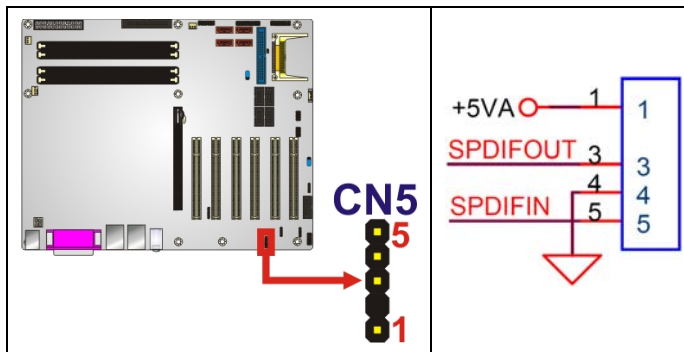

Figure 4-22: SPDIF Connector Pinout Locations

PIN	DESCRIPTION
-----	-------------

IMBA-9454G Motherboard

1	VCC AUDIO
2	NC
3	SPDIF OUT
4	GND AUDIO
5	SPDIF IN

Table 4-24: SPDIF Connector Pinouts

4.2.22 TPM Connector

CN Label: TPM1

CN Type: 20-pin header (2x10)

CN Location: See Figure 4-23

CN Pinouts: See Table 4-25

Use the TPM connector to connect a TPM module to the system.

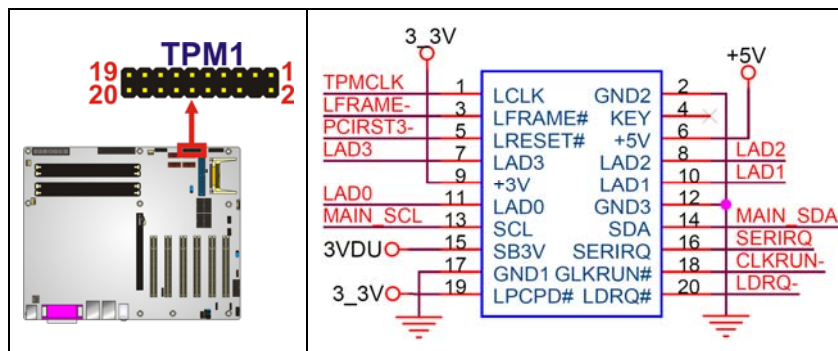

Figure 4-23: TPM Connector Pinout Locations

PIN	DESCRIPTION	PIN	DESCRIPTION
1	LCLK	2	GND
3	LFRAME#	4	KEY
5	LRESET#	6	+5V
7	LAD3	8	LAD2
9	+3V	10	LAD1
11	LAD0	12	GND
13	SCL	14	SDA

15	SB3V	16	SERIRQ
17	GND	18	GLKRUN#
19	LPCPD#	20	LDRO#

Table 4-25: TPM Connector Pinouts

4.2.23 USB Connectors (Internal)

- CN Label:** USB3, USB4
- CN Type:** 8-pin header (2x4)
- CN Location:** See Figure 4-24
- CN Pinouts:** See Table 4-26

The 2x4 USB pin connectors each provide connectivity to two USB 1.1 or two USB 2.0 ports. Each USB connector can support two USB devices. Additional external USB ports are found on the rear panel. The USB ports are used for I/O bus expansion.

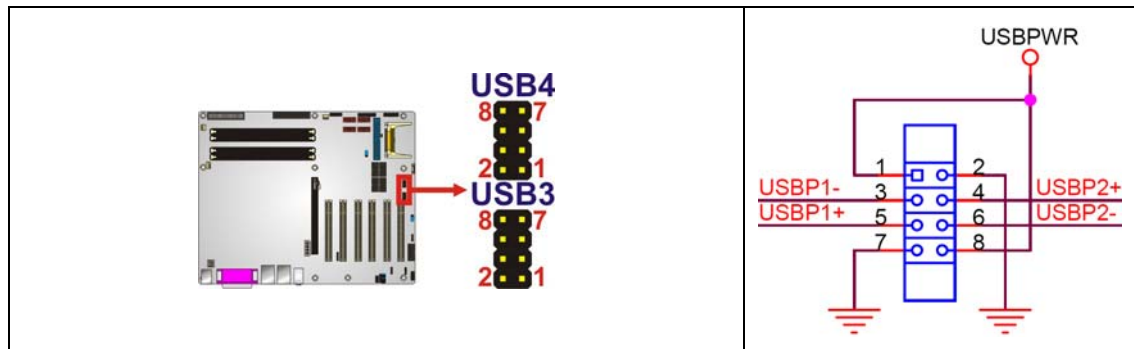
Figure 4-24: USB Connector Pinout Locations

PIN	DESCRIPTION	PIN	DESCRIPTION
1	PWR (+5V)	2	GND
3	USBPB-	4	USBPB+
5	USBPA+	6	USBPB-
7	GND	8	PWR (+5V)

Table 4-26: USB Port Connector Pinouts

IMBA-9454G Motherboard

4.3 External Peripheral Interface Connectors

The external peripheral interface connectors on the back panel are connected to devices externally when the IMBA-9454G is installed in a chassis. The peripheral connectors on the rear panel are:

- 1 x Keyboard/mouse connector
- 1 x Parallel port connector
- 2 x RJ-45 Ethernet connector
- 3 x Audio jacks
- 4 x USB 2.0 connectors
- 1 x VGA connector
- 1 x Serial port connector

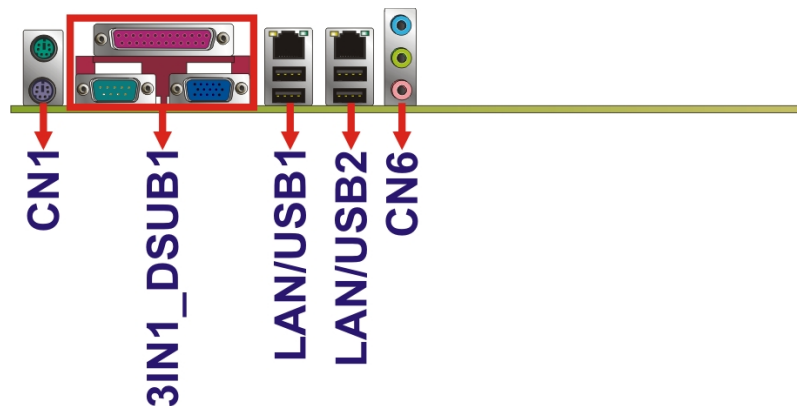

Figure 4-25: IMBA-9454G External Interface Connectors

4.3.1 Keyboard/Mouse Connector

CN Label:	KBMS1
CN Type:	PS/2 connector
CN Location:	See Figure 4-25 (labeled number 1)
CN Pinouts:	See Figure 4-26 and Table 4-27

The IMBA-9454G keyboard and mouse connectors are standard PS/2 connectors.

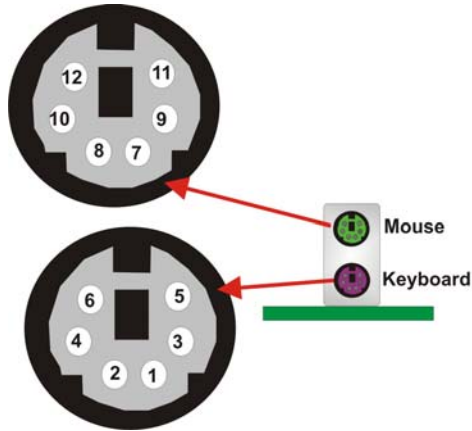

Figure 4-26: PS/2 Pinouts

PIN	DESCRIPTION	PIN	DESCRIPTION
1	L_KDAT	7	L_MDAT
2	NC	8	NC
3	GND	9	GND
4	5V	10	5V
5	L_KCLK	11	L_MCLK
6	NC	12	NC

Table 4-27: PS/2 Connector Pinouts

4.3.2 Parallel Port Connector

CN Label: 3IN1_DSUB1A

CN Type: DB-25

CN Location: See Figure 4-25 (labeled number 2)

CN Pinouts: See Figure 4-27 and Error! Reference source not found.

These ports are usually connected to a printer. IMBA-9454G includes one on-board parallel ports accessed through one 25-pin D-type female connector.

IMBA-9454G Motherboard

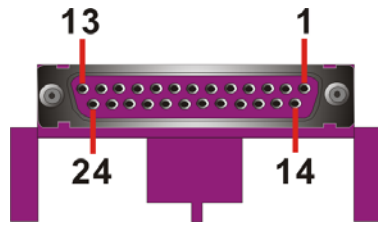

Figure 4-27: Parallel Port Connector Pinout Locations

PIN	Description	PIN	Description
1	STROBE#	2	DATA 0
3	DATA 1	4	DATA 2
5	DATA 3	6	DATA 4
7	DATA 5	8	DATA 6
9	DATA 7	10	ACKNOWLEDGE
11	BUSY	12	PAPER EMPTY
13	PRINTER SELECT	14	AUTO FORM FEED #
15	ERROR#	16	INITIALIZE
17	PRINTER SELECT LN#	18	GND
19	GND	20	GND
21	GND	22	GND
23	GND	24	GND
25	GND		

Table 4-28: Parallel Port Connector Pinouts

4.3.3 Ethernet Connector

CN Label: LAN/USB1B, LAN/USB2B

CN Type: RJ-45 ports

CN Location: See Figure 4-25 (labeled 3)

CN Pinouts: See Figure 4-28, and **Table 4-30**

A 1Gb connection can be made between the Ethernet connectors and a Local Area Network (LAN) through a network hub.

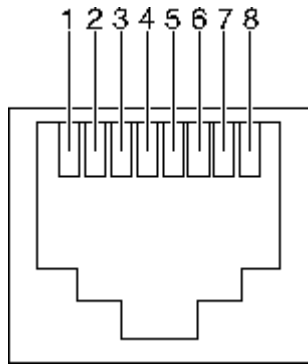

Figure 4-28: Ethernet Connector Pinout Locations

PIN	DESCRIPTION	PIN	DESCRIPTION
1	TX+ (or MDX0+)	5	N/C (or MDX2-)
2	TX- (or MDX0-)	6	RX- (or MDX1-)
3	RX+ (or MDX1+)	7	N/C (or MDX3+)
4	N/C (or MDX2+)	8	N/C (or MDX3-)
13	MDX0+	17	MDX2-
14	MDX0-	18	MDX1-
15	MDX1+	19	MDX3+
16	MDX2+	20	MDX3-
1	TX+ (or MDX0+)	5	N/C (or MDX2-)
2	TX- (or MDX0-)	6	RX- (or MDX1-)

Table 4-29: Ethernet Connector Pinouts

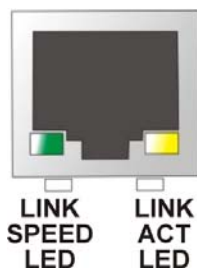

Figure 4-29: Ethernet Connector

The RJ-45 Ethernet connector has two status LEDs, one green and one yellow. The green LED indicates activity on the port and the yellow LED indicates the port is linked (Table 4-30).

IMBA-9454G Motherboard

SPEED LED		LINK LED	
Status	Description	Status	Description
GREEN	ON: 100MB OFF: 10MB	YELLOW	ON: Linked Flashing: Activity

Table 4-30: Ethernet Connector LEDs

4.3.4 Audio Connectors

CN Label: CN6

CN Type: Audio jack

CN Location: See Figure 4-25 (labeled number 4)

CN Pinouts: See Figure 4-30

- **Line In port (Light Blue):** Connects a CD-ROM, DVD player, or other audio devices.
- **Speaker Out port (Lime):** Connects to a headphone or a speaker. With multi-channel configurations, this port can also connect to front speakers.
- **Microphone (Pink):** Connects a microphone.

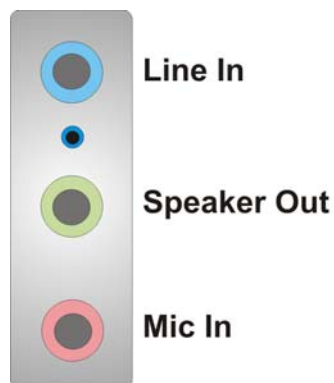

Figure 4-30: Audio Connector

4.3.5 USB Connectors

CN Label: LAN/USB1B, LAN/USB2B

CN Type: Dual USB port

CN Location: See Figure 4-25 (labeled 5)

CN Pinouts: See Figure 4-31 and Table 4-31

USB devices connect directly to the USB connectors on the external peripheral connector panel.

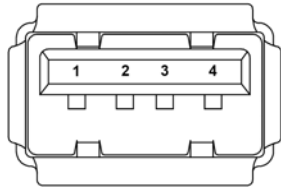

Figure 4-31: USB Connector Pinout Locations

PIN	DESCRIPTION	PIN	DESCRIPTION
1	VCC	5	VCC
2	USBD0-	6	USBD0-
3	USBD0+	7	USBD0+
4	GND	8	GND

Table 4-31: USB Connector Pinouts

4.3.6 VGA Connector

CN Label: 3IN1_DSUB1C

CN Type: HD-D-sub 15 Female connector

CN Location: See Figure 4-25 (labeled 6)

CN Pinouts: See **Figure 4-32** and **Table 4-32**

The standard HD-D-sub 15 female connector connects to a CRT or LCD monitor.

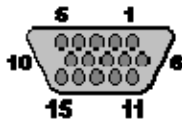

Figure 4-32: VGA Connector

PIN	Description	PIN	Description
-----	-------------	-----	-------------

IMBA-9454G Motherboard

PIN	Description	PIN	Description
1	RED	2	GREEN
3	BLUE	4	N/C
5	GND	6	GND
7	GND	8	GND
9	VCC	10	GND
11	N/C	12	DDC DAT
13	HSYNC	14	VSYNC
15	DDC CLK		

Table 4-32: VGA Connector Pinouts

4.3.7 Serial Communications Connector

- CN Label: 3IN1_DSUB1B
- CN Type: D-sub 9 Male connector
- CN Location: See Figure 4-25 (labeled 7)
- CN Pinouts: See **Figure 4-33** and **Table 4-33**

The serial connector on the external interface panel provides serial connection in the RS-232 mode.

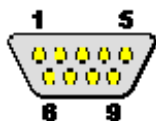

Figure 4-33: Serial Communications Connector Pinout Locations

PIN	DESCRIPTION
1	DATA CARRIER DETECT (DCD)
2	RECEIVE DATA (RXD)
3	TRANSMIT DATA (TXD)
4	DATA TERMINAL READY (DTR)
5	GROUND (GND)
6	DATA SET READY (DSR)
7	REQUEST TO SEND (RTS)

PIN	DESCRIPTION
8	CLEAR TO SEND (CTS)
9	RING INDICATOR (RI)

Table 4-33: COM1 RS-232 Mode Connector Pinouts

4.4 On-board Jumpers

The NANO-4386A has fifteen on-board jumpers. Refer to **Section 5.4** for jumper configuration settings.

Chapter

5

Installation

IMBA-9454G Motherboard

5.1 Anti-static Precautions



WARNING:

Failure to take ESD precautions during the installation of the IMBA-9454G may result in permanent damage to the IMBA-9454G and severe injury to the user.

Electrostatic discharge (ESD) can cause serious damage to electronic components, including the IMBA-9454G. Dry climates are especially susceptible to ESD. It is therefore critical that whenever the IMBA-9454G, or any other electrical component is handled, the following anti-static precautions are strictly adhered to.

- ***Wear an anti-static wristband:*** Wearing a simple anti-static wristband can help to prevent ESD from damaging the board.
- ***Self-grounding:*** Before handling the board, touch any grounded conducting material. During the time the board is handled, frequently touch any conducting materials that are connected to the ground.
- ***Use an anti-static pad:*** When configuring the IMBA-9454G, place it on an anti-static pad. This reduces the possibility of ESD damage.
- ***Only handle the edges of the PCB:*** When handling the PCB, hold it by its edges.

5.2 Installation Considerations



NOTE:

The following installation notices and installation considerations should be read and understood before the IMBA-9454G is installed. All installation notices pertaining to the installation of the IMBA-9454G should be strictly adhered to. Failing to adhere to these precautions may lead to severe damage of the IMBA-9454G and injury to the person installing the motherboard.

5.2.1 Installation Notices



WARNING:

The installation instructions described in this manual should be carefully followed in order to prevent damage to the IMBA-9454G and injury to the user.

Before and during the installation please DO the following:

- **Read the user manual:**
 - The user manual provides a complete description of the IMBA-9454G installation instructions and configuration options.
- **Wear an electrostatic discharge cuff (ESD):**
 - Electronic components are easily damaged by ESD. Wearing an ESD cuff removes ESD from the body and helps prevent ESD damage.
- **Place the IMBA-9454G on an antistatic pad:**
 - When installing or configuring the motherboard, place it on an antistatic pad. This helps to prevent potential ESD damage.
- **Turn off all power to the IMBA-9454G:**
 - When working with the IMBA-9454G, make sure that it is disconnected from all power supplies and that no electricity is being fed into the system.

Before and during the installation of the IMBA-9454G **DO NOT**:

- Remove any of the stickers on the PCB board. These stickers are required for warranty validation.
- Use the product before verifying all the cables and power connectors are properly connected.
- Allow screws to come in contact with the PCB circuit, connector pins, or its components.

5.2.2 Installation Checklist

The following checklist is provided to ensure the IMBA-9454G is properly installed.

IMBA-9454G Motherboard

- All the items in the packing list are present (see **Chapter 3**)
- A CPU is installed
- A CPU cooling kit is properly installed
- Compatible memory modules are properly inserted into the memory slots
- The IMBA-9454G is installed into a chassis with adequate ventilation
- The correct power supply is being used
- The following devices (if applicable) are properly connected
 - IDE devices
 - SATA drives
 - Floppy disk drive
 - System front panel connector
 - Audio kit
 - Power supply
 - USB cable
 - Serial port cable
 - Parallel port cable
 - Keyboard/mouse cable
 - COM port cables
- The following external peripheral devices (if applicable) are properly connected to the chassis:
 - VGA screen
 - Keyboard
 - Mouse
 - USB devices
 - LAN
 - Audio jacks

5.3 CPU, CPU Cooling Kit and DIMM Installation



WARNING:

A CPU should never be turned on without the specified cooling kit being installed. If the cooling kit (heat sink and fan) is not properly installed and the system turned on, permanent damage to the CPU and other electronic components attached to the system may be incurred. Running a CPU without a cooling kit may also result in injury to the user.

The CPU, CPU cooling kit and DIMM are the most critical components of the IMBA-9454G. If any of these components is not installed, the IMBA-9454G cannot operate.

5.3.1 LGA775 CPU Installation



NOTE:

Enabling Hyper-Threading Technology on the system requires meeting all of the platform requirements listed below:

- **CPU:** An Intel® Pentium 4 Processor (or better) with HT Technology must be installed
 - **Chipset:** An Intel® Chipset that supports HT Technology
 - **OS:** An operating system that has optimizations for HT Technology
-
-



WARNING:

CPUs are expensive and sensitive components. When installing the CPU please be careful not to damage it in anyway. Make sure the CPU is installed properly and ensure the correct cooling kit is properly installed.

IMBA-9454G Motherboard

The LGA775 is shown in Figure 5-1.

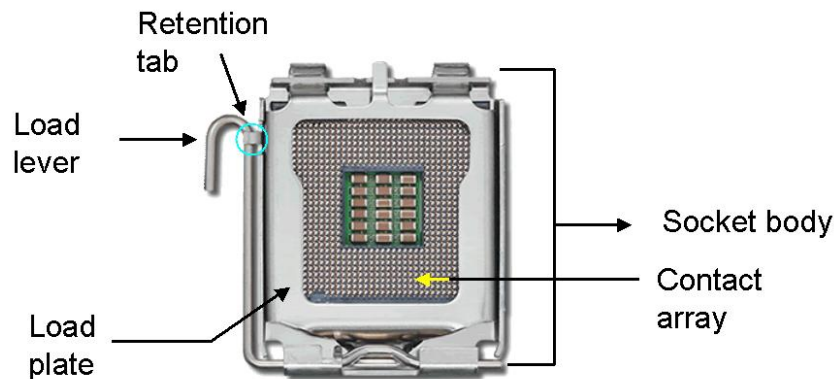

Figure 5-1: Intel LGA775

To install a LGA775 CPU onto the IMBA-9454G, follow the steps below:



WARNING:

When handling the CPU, only hold it on the sides. DO NOT touch the pins at the bottom of the CPU.

Step 1: Remove the protective cover. Remove the black protective cover by prying it off the load plate. To remove the protective cover, locate the “REMOVE” sign and use your fingernail to pry the protective cover off. See Figure 5-2.

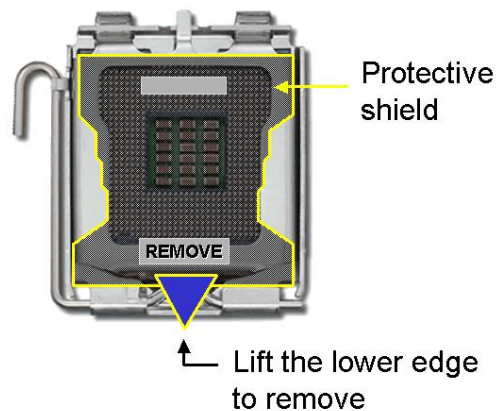

Figure 5-2: Remove the CPU Socket Protective Shield

Step 2: Open the socket. Disengage the load lever by pressing the lever down and slightly outward to clear the retention tab. Rotate the load lever to a fully open position. Then rotate the load plate towards the opposite direction. See Figure 5-3.

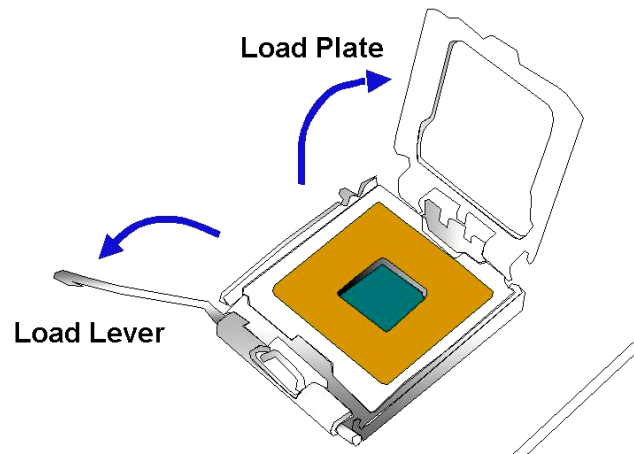

Figure 5-3: Open the CPU Socket Load Plate

Step 3: Inspect the CPU socket Make sure there are no bent pins and make sure the socket contacts are free of foreign material. If any debris is found, remove it with compressed air.

IMBA-9454G Motherboard

- Step 4:** Orientate the CPU properly. Make sure the IHS (Integrated Heat Sink) side is facing upward.
- Step 5:** Correctly position the CPU. Match the Pin 1 mark with the cut edge on the CPU socket.
- Step 6:** Align the CPU pins. Locate pin 1 and the two orientation notches on the CPU. Carefully match the two orientation notches on the CPU with the socket alignment keys.
- Step 7:** Insert the CPU. Gently insert the CPU into the socket. If the CPU pins are properly aligned, the CPU should slide into the CPU socket smoothly. See Figure 5-4.

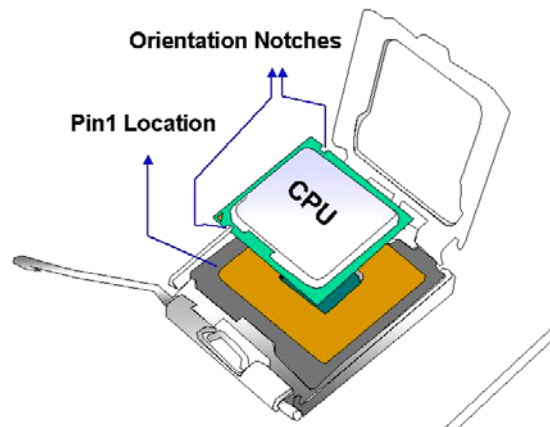

Figure 5-4: Insert the LGA775 CPU

- Step 8:** Close the CPU socket. Close the load plate and engage the load lever by pushing it back to its original position. Secure the load lever under the retention tab on the side of CPU socket.
- Step 9:** Connect the CPU 12V cable to the 12V power connector. After the cooling kit is installed connect the CPU cable to the CPU 12V power connector

5.3.2 LGA775 Cooling Kit Installation

**WARNING:**

It is strongly recommended that the original heat sink and cooler provided by Intel not be used on the IMBA-9454G.

IEI's cooling kits include a support bracket that is combined with the heat sink mounted on the CPU to counterweigh and balance the load on both sides of the PCB.

**CF-520-RS****CF-775A-RS****Figure 5-5: IEI Cooling Kits**

The IEI LGA775 CPU cooling kits shown in Figure 5-5 can be purchased separately. The cooling kits comprise of a CPU heat sink and a cooling fan.

**WARNING:**

Do not wipe off (accidentally or otherwise) the pre-sprayed layer of thermal paste on the bottom of the heat sink. The thermal paste between the CPU and the heat sink is important for optimum heat dissipation.

Follow the instructions below to install a cooling kit.

IMBA-9454G Motherboard

- Step 1:** Place the cooling kit onto the LGA775 CPU. Make sure the CPU cable can be properly routed when the cooling kit is installed.
- Step 2:** Properly align the cooling kit. Make sure the four spring screw fasteners can pass through the pre-drilled holes on the PCB.
- Step 3:** Mount the cooling kit. Gently place the cooling kit on top of the CPU. Make sure the four threaded screws on the corners of the cooling kit properly pass through the predrilled holes on the bottom of the PCB.
- Step 4:** Secure the cooling kit. From the solder side of the PCB, align the support bracket to the screw threads on heat sink that were inserted through the PCB holes. (See Figure 5-6)

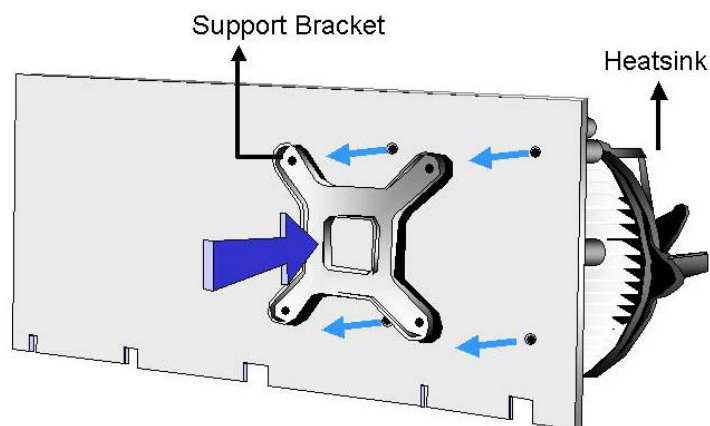

Figure 5-6: Securing the Heat sink to the PCB Board

- Step 5:** Tighten the screws. Use a screwdriver to tighten the four screws. Tighten each nut a few turns at a time and do not over-tighten the screws.
- Step 6:** Connect the fan cable. Connect the cooling kit fan cable to the fan connector on the IMBA-9454G. Carefully route the cable and avoid heat generating chips and fan blades.

5.3.3 DIMM Installation



WARNING:

Using incorrectly specified DIMM may cause permanently damage the IMBA-9454G. Please make sure the purchased DIMM complies with the memory specifications of the IMBA-9454G. DIMM specifications compliant with the IMBA-9454G are listed in **Chapter 2**.

To install a DIMM into a DIMM socket, please follow the steps below and refer to **Figure 5-7**.

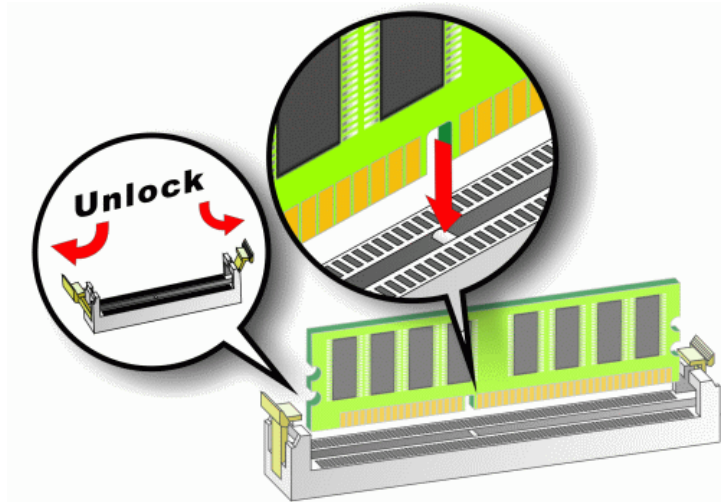

Figure 5-7: Installing a DIMM

- Step 1:** **Open the DIMM socket handles.** The DIMM socket has two handles that secure the DIMM into the socket. Before the DIMM can be inserted into the socket, the handles must be opened. See **Figure 5-7**.
- Step 2:** **Align the DIMM with the socket.** The DIMM must be oriented in such a way that the notch in the middle of the DIMM must be aligned with the plastic bridge in the socket. See **Figure 5-7**.

IMBA-9454G Motherboard

Step 3: Insert the DIMM. Once properly aligned, the DIMM can be inserted into the socket. As the DIMM is inserted, the white handles on the side of the socket will close automatically and secure the DIMM to the socket. See **Figure 5-7**.

Step 4: Removing a DIMM. To remove a DIMM, push both handles outward. The memory module is ejected by a mechanism in the socket.

5.4 Jumper Settings



NOTE:

A jumper is a metal bridge used to close an electrical circuit. It consists of two or three metal pins and a small metal clip (often protected by a plastic cover) that slides over the pins to connect them. To CLOSE/SHORT a jumper means connecting the pins of the jumper with the plastic clip and to OPEN a jumper means removing the plastic clip from a jumper.

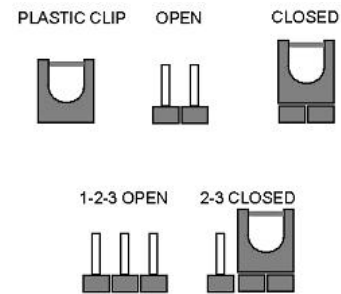

Figure 5-8: Jumper Locations

Before the IMBA-9454G is installed in the system, the jumpers must be set in accordance with the desired configuration. The jumpers on the IMBA-9454G are listed in Table 5-1.

Description	Label	Type
CF Master/Slave Selection	JP2	2-pin header
Clear CMOS	JP1	3-pin header
COM2 Mode Selection	JP4	3-pin header
SPI Flash Connector	JSPI1	8-pin header

Table 5-1: Jumpers

5.4.1 CF Master/Slave Selection

- Jumper Label:** JP2
- Jumper Type:** 2-pin header
- Jumper Settings:** See Table 5-2

The CF Master/Slave Selection jumper sets the CF Type I card or CF Type II cards as either the slave device or the master device. CF Master/Slave Selection jumper settings are shown in **Table 5-2**.

Pins	Description	
Open	Slave	Default
Short	Master	

Table 5-2: CF Master/Slave Selection Settings

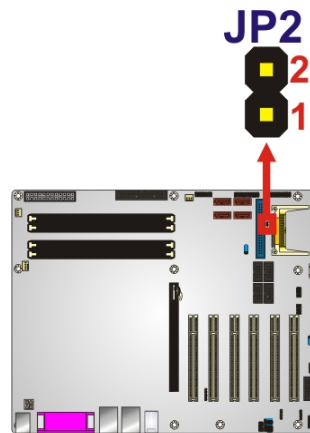

Figure 5-9: Jumper Locations

5.4.2 Clear CMOS Jumper

- Jumper Label:** JP1
- Jumper Type:** 3-pin header
- Jumper Settings:** See Table 5-3

If the IMBA-9454G fails to boot due to improper BIOS settings, the clear CMOS jumper clears the CMOS data and resets the system BIOS information. To do this, use the jumper

IMBA-9454G Motherboard

cap to close pins 2 and 3 for a few seconds then reinstall the jumper clip back to pins 1 and 2.

If the “CMOS Settings Wrong” message is displayed during the boot up process, the fault may be corrected by pressing the F1 to enter the CMOS Setup menu. Do one of the following:

- Enter the correct CMOS setting
- Load Optimal Defaults
- Load Failsafe Defaults.

After having done one of the above, save the changes and exit the CMOS Setup menu.

The clear CMOS jumper settings are shown in Table 5-3.

Pins	Description	
Short 1 - 2	Keep CMOS Setup	Default
Short 2 – 3	Clear CMOS Setup	

Table 5-3: Clear CMOS Jumper Settings

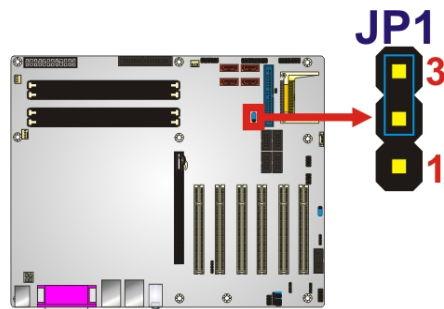

Figure 5-10: Clear CMOS Jumper Location

5.4.3 COM2 Mode Selection

Jumper Label:	JP4
Jumper Type:	3-pin header
Jumper Settings:	See Table 5-4

The COM2 Mode Selection jumper sets the communication protocol used by the second serial communications port (COM 2) as RS-232, RS-422 or RS-485. The COM2 Mode Selection settings are shown in Table 5-4.

Pins	Description	
Short 1-3	RS-232	Default
Short 3-5	RS-422/485	

Table 5-4: COM2 Mode Selection Jumper Settings

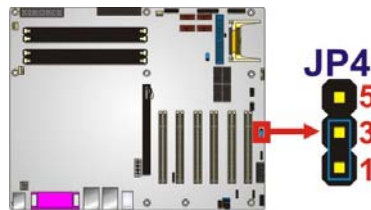

Figure 5-11: COM2 Mode Selection Jumper Location

5.4.4 SPI Flash Connector

- Jumper Label:** JSPI1
- Jumper Type:** 8-pin header
- Jumper Settings:** See Table 5-4

The 8-pin SPI Flash connector is used to flash the BIOS.

Pin No.	Description	Pin No.	Description
1	SPI_VCC	2	GND
3	SPI_CS	4	SPI_CLK
5	SPI_SO	6	SPI_SI
7	NC	8	NC

Table 5-5: SPI Flash Jumper Settings

IMBA-9454G Motherboard

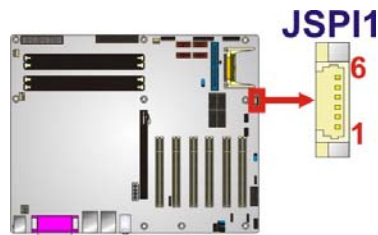

Figure 5-12: SPI Flash Jumper Location

5.5 Chassis Installation

5.5.1 Airflow



WARNING

Airflow is critical to the cooling of the CPU and other onboard components. The chassis into which the IMBA-9454G is placed must have air vents to allow proper airflow to cool the system components.

The IMBA-9454G must be installed in a chassis with ventilation holes on the sides allowing airflow to travel over the heat sink surface. In a system with an individual power supply unit, the cooling fan of a power supply can also help generate airflow over the board surface.



NOTE

IEI has a wide range of chassis available. Please contact your IMBA-9454G vendor, reseller or an IEI sales representative at sales@iei.com.tw or visit the IEI website (<http://www.ieworld.com.tw>) to find out more about available chassis.

5.6 Internal Peripheral Device Connections

5.6.1 Peripheral Device Cables

The cables listed in Table 5-6 are shipped with the IMBA-9454G.

Quantity	Type
1	ATA 66/100 flat cable
2	Dual RS-232 cables
2	SATA drive cables
1	SATA drive power cable

Table 5-6: IEI Provided Cables

5.6.2 ATA Flat Cable Connection

The ATA 66/100 flat cable connects to an IDE device. Follow the instructions below to connect an IDE HDD to the IMBA-9454G.

Step 1: Locate the IDE connector. The locations of the IDE device connectors are shown in **Chapter 3**.

Step 2: Insert the connector. Connect the IDE cable connector to the onboard connector. See **Figure 5-13**. A key on the front of the cable connector ensures it can only be inserted in one direction.

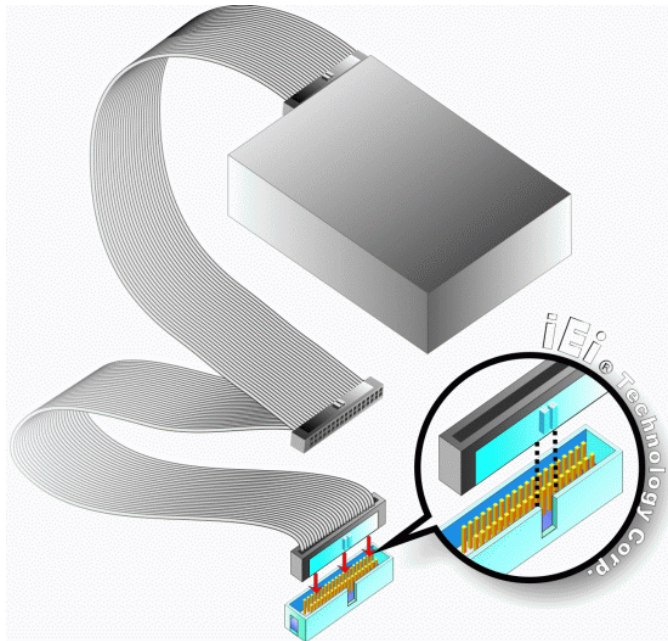

Figure 5-13: IDE Cable Connection

IMBA-9454G Motherboard

Step 3: **Connect the cable to an IDE device.** Connect the two connectors on the other side of the cable to one or two IDE devices. Make sure that pin 1 on the cable corresponds to pin 1 on the connector

5.6.3 Dual RS-232 Cable Connection

The dual RS-232 cable consists of two serial port connectors attached to a serial communications cable that is then attached to two bracket mounted D-sub 9 male connectors. To install the dual RS-232 cable, please follow the steps below.

Step 1: **Locate the connector.** The location of the RS-232 connector is shown in Chapter 3.

Step 2: **Insert the cable connector.** Insert the connectors into the serial port box headers. See **Figure 5-14**. A key on the front of the cable connectors ensures the connectors can only be installed in one direction.

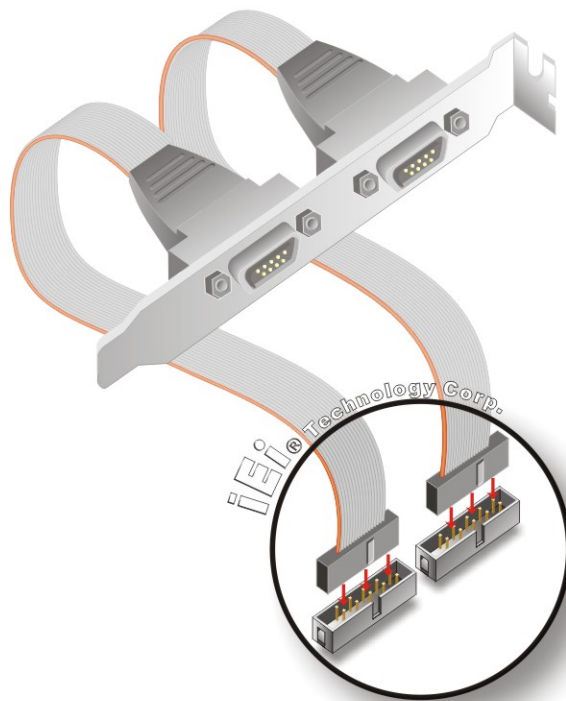

Figure 5-14: Dual RS-232 Cable Installation

Step 3: Secure the bracket. The dual RS-232 connector has two D-sub 9 male connectors secured to a bracket. To secure the bracket to a chassis please refer to the reference material that came with the chassis

5.6.4 SATA Drive Connection

The IMBA-9454G is shipped with SATA drive cables and SATA drive power cable. Follow the steps below to connect the SATA drives to the motherboard.

Step 1: Locate the connectors. The locations of the SATA drive connectors are shown in **Chapter 3**.

Step 2: Insert the cable connector. Press the clip on the connector at the end of the SATA cable and insert the cable connector into the onboard SATA drive connector. See **Figure 5-15**.

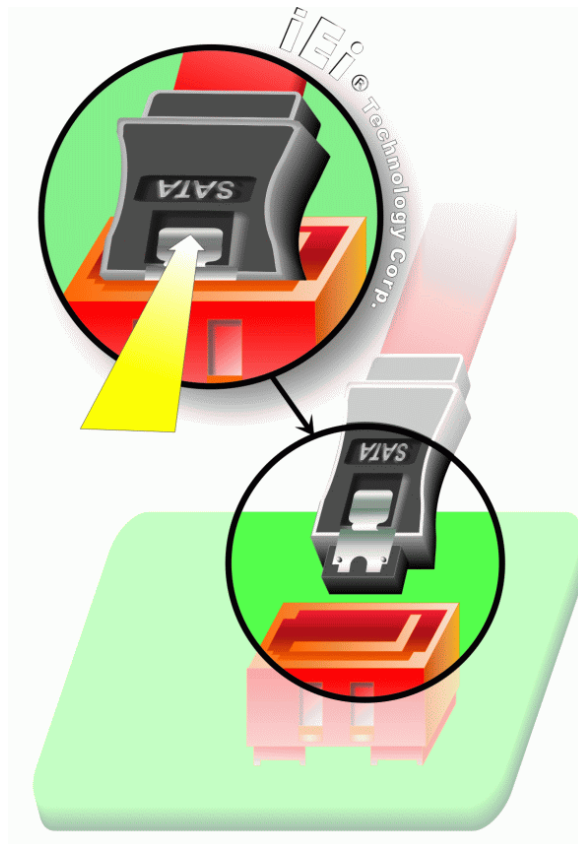

Figure 5-15: SATA Drive Cable Connection

IMBA-9454G Motherboard

Step 3: Connect the cable to the SATA disk. Connect the connector on the other end of the cable to the connector at the back of the SATA drive. See **Figure 5-16**.

Step 4: Connect the SATA power cable. Connect the SATA power connector to the back of the SATA drive. See **Figure 5-16**.

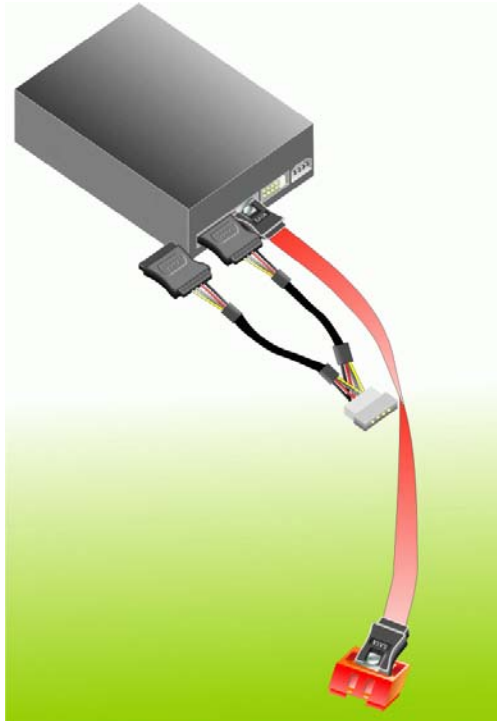

Figure 5-16: SATA Power Drive Connection

5.7 External Peripheral Interface Connection

The following external peripheral devices can be connected to the external peripheral interface connectors.

- Mouse and keyboard
- Parallel devices
- RJ-45 Ethernet cable connectors
- USB devices
- Audio devices
- VGA monitor
- Serial devices

To install these devices, connect the corresponding cable connector from the actual device to the corresponding IMBA-9454G external peripheral interface connector making sure the pins are properly aligned.

5.7.1 PS/2 Keyboard/Mouse Connection

The IMBA-9454G has a dual PS/2 connector on the external peripheral interface panel. The dual PS/2 connector is used to connect to a keyboard and mouse to the system. Follow the steps below to connect a keyboard and mouse to the IMBA-9454G.

Step 1: **Locate the dual PS/2 connector.** The location of the dual PS/2 connector is shown in **Chapter 3**.

Step 2: **Insert the keyboard/mouse connector.** Insert a PS/2 keyboard or mouse connector into the appropriate PS/2 connector on the external peripheral interface connector. See **Figure 5-17**.

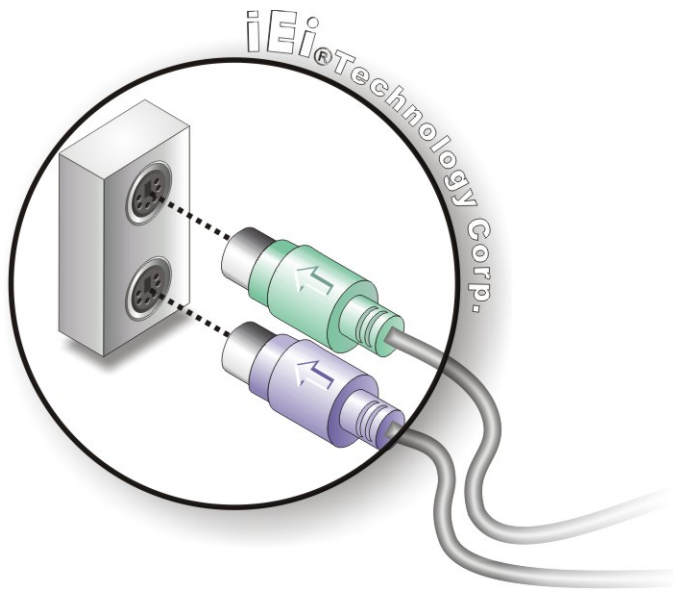

Figure 5-17: PS/2 Keyboard/Mouse Connector

IMBA-9454G Motherboard

5.7.2 Parallel Device Connection

The IMBA-9454G has a single female DB-25 connector on the external peripheral interface panel for parallel devices. Follow the steps below to connect a parallel device to the IMBA-9454G.

Step 1: Locate the DB-25 connector. The location of the DB-25 connector is shown in Chapter 3.

Step 2: Insert the DB-25 connector. Insert the DB-25 connector of a parallel device into the DB-25 connector on the external peripheral interface. See Figure 5-18.

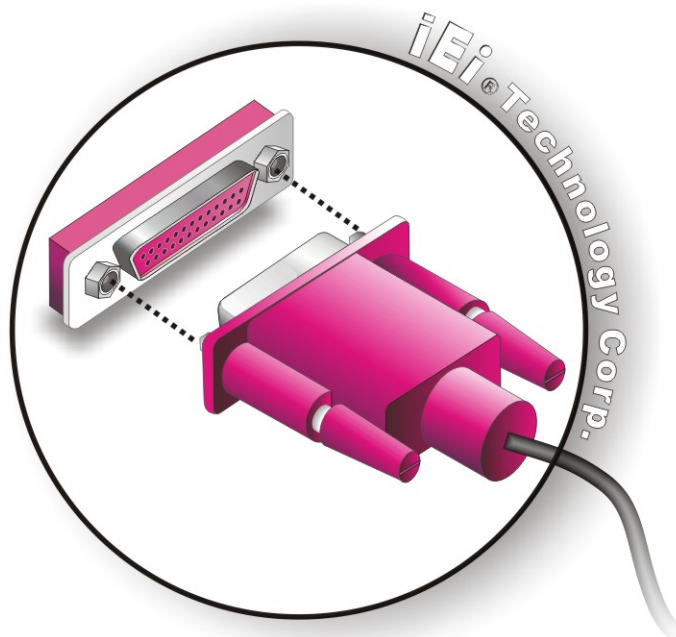

Figure 5-18: Parallel Device Connector

Step 3: Secure the connector. Secure the DB-25 connector to the external interface by tightening the two retention screws on either side of the connector.

5.7.3 RJ-45 Ethernet Connection

The IMBA-9454G has two RJ-45 Ethernet connectors on the external peripheral interface panel for LAN communications. Follow the steps below to connect an RJ-45 Ethernet connector to the IMBA-9454G.

Step 1: Locate the RJ-45 connector. The location of the RJ-45 connector is shown in Chapter 3.

Step 2: Insert an RJ-45 plug. Insert the RJ-45 plug of a LAN into the RJ-45 receptacle on the external peripheral interface. See Figure 5-19.

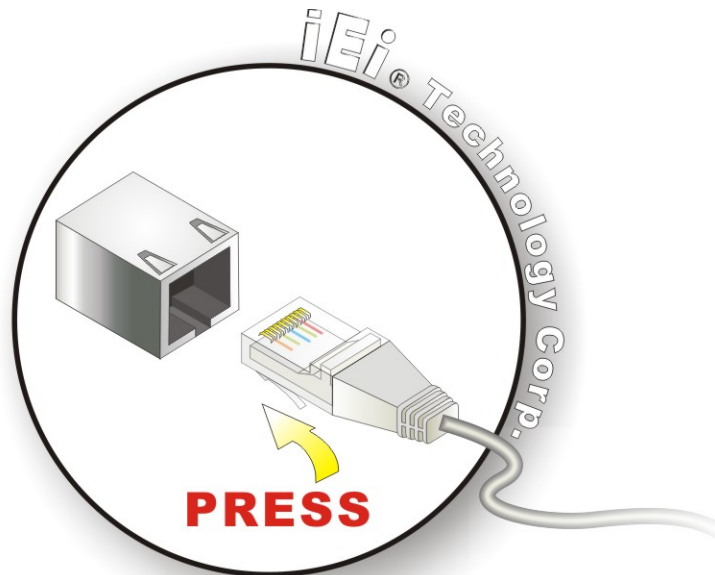

Figure 5-19: RJ-45 Ethernet Connector

5.7.4 USB Connection

The external USB Series "A" receptacle connectors provide easier and quicker access to external USB devices. Follow the steps below to connect USB devices to the IMBA-9454G.

Step 1: Locate the USB Series "A" receptacle connectors. The location of the USB Series "A" receptacle connectors are shown in Chapter 3.

Step 2: Insert a USB Series "A" plug. Insert the USB Series "A" plug of a device into the USB Series "A" receptacle on the external peripheral interface. See Figure 5-20.

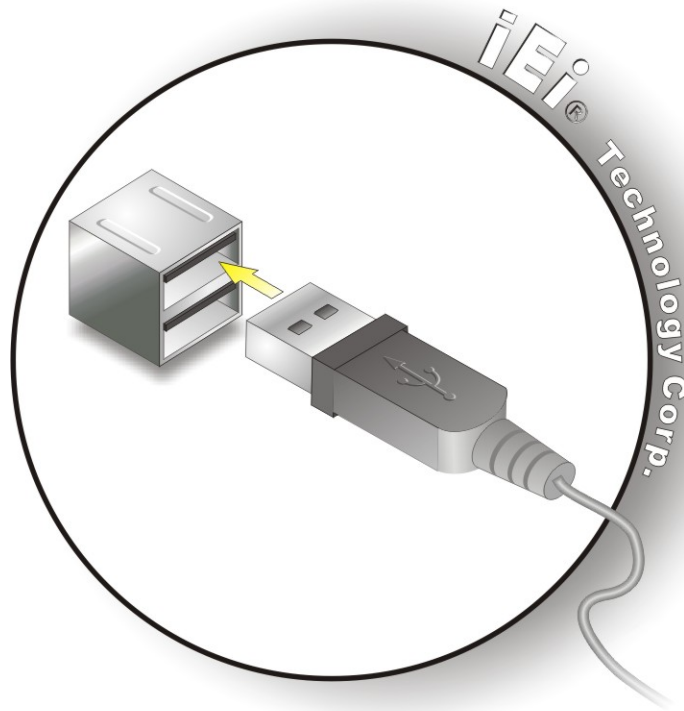

Figure 5-20: USB Connector

5.7.5 Audio Connection

Audio signals are interfaced through three phone jack connections. The red phone jack is for Mic In, blue is for Line In and green is for Speaker Out. Follow the steps below to connect audio devices to the IMBA-9454G.

- Step 1:** **Locate the audio phone jacks.** The location of the audio phone jacks are shown in **Chapter 3**.
- Step 2:** **Insert audio phone jack plugs.** Insert audio phone jack plugs into the audio phone jacks on the external peripheral interface. See Figure 5-21.

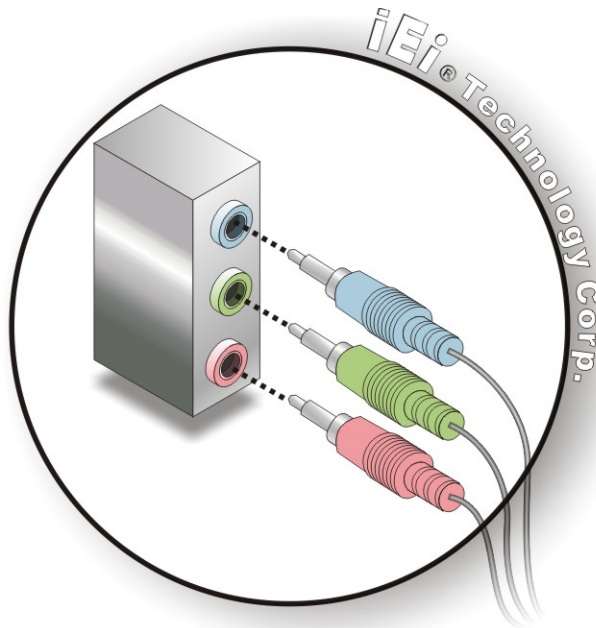

Figure 5-21: Audio Connectors

5.7.6 VGA Monitor Connection

The IMBA-9454G has a single female DB-15 connector on the external peripheral interface panel for a VGA monitor. Follow the steps below to connect a VGA monitor to the IMBA-9454G.

- Step 1:** **Locate the DB-15 connector.** The location of the DB-15 connector is shown in Chapter 3.
- Step 2:** **Insert the VGA connector.** Insert the DB-15 connector of a VGA monitor into the DB-15 connector on the external peripheral interface. See **Figure 5-22**.

IMBA-9454G Motherboard

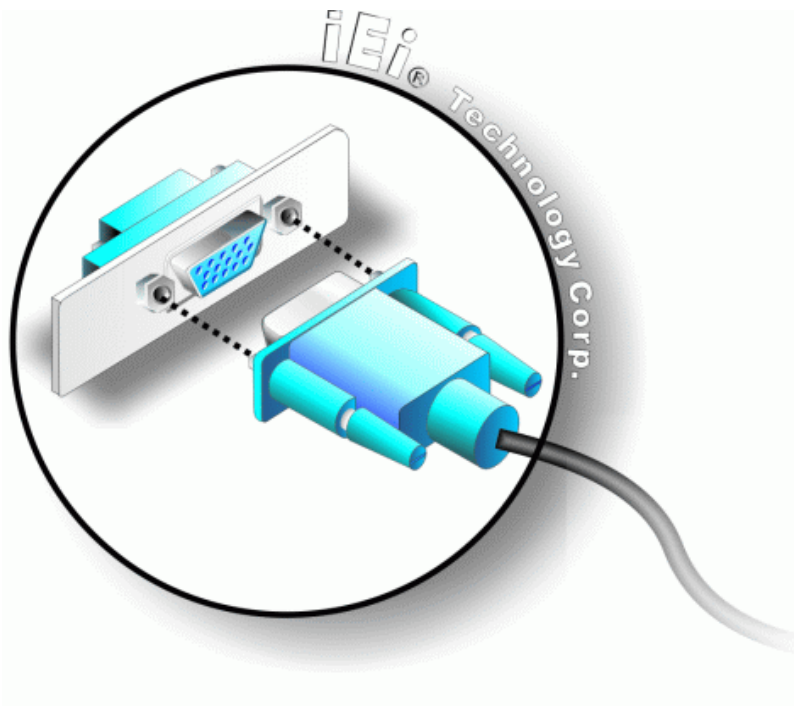

Figure 5-22: VGA Connector

Step 3: Secure the connector. Secure the VGA connector to the external interface by tightening the two retention screws on either side of the connector.

5.7.7 Serial Device Connection

The IMBA-9454G has a single female DB-9 connector on the external peripheral interface panel for a serial device. Follow the steps below to connect a serial device to the IMBA-9454G.

Step 1: Locate the DB-9 connector. The location of the DB-9 connector is shown in Chapter 3.

Step 2: Insert the serial connector. Insert the DB-9 connector of a serial device into the DB-9 connector on the external peripheral interface. See Figure 5-23.

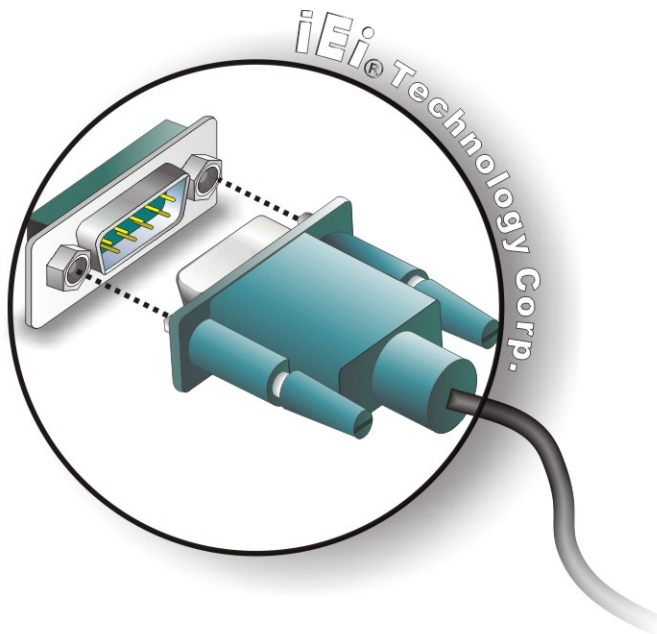

Figure 5-23: Serial Device Connector

Step 3: Secure the connector. Secure the serial device connector to the external interface by tightening the two retention screws on either side of the connector.

Chapter

6

AMI BIOS

IMBA-9454G Motherboard

6.1 Introduction

A licensed copy of AMI BIOS is preprogrammed into the ROM BIOS. The BIOS setup program allows users to modify the basic system configuration. This chapter describes how to access the BIOS setup program and the configuration options that may be changed.

6.1.1 Starting Setup

The AMI BIOS is activated when the computer is turned on. The setup program can be activated in one of two ways.

1. Press the **DELETE** key as soon as the system is turned on or
2. Press the **DELETE** key when the “**Press Del to enter SETUP**” message appears on the screen.

If the message disappears before the **DELETE** key is pressed, restart the computer and try again.

6.1.2 Using Setup

Use the arrow keys to highlight items, press **ENTER** to select, use the PageUp and PageDown keys to change entries, press **F1** for help and press **ESC** to quit. Navigation keys are shown in the following table.

Key	Function
Up arrow	Move to previous item
Down arrow	Move to next item
Left arrow	Move to the item on the left hand side
Right arrow	Move to the item on the right hand side
Esc key	Main Menu – Quit and not save changes into CMOS Status Page Setup Menu and Option Page Setup Menu -- Exit current page and return to Main Menu
Page Up key	Increase the numeric value or make changes
Page Dn key	Decrease the numeric value or make changes

Key	Function
F1 key	General help, only for Status Page Setup Menu and Option Page Setup Menu
F2 /F3 key	Change color from total three colors. F2 to select color forward.
F10 key	Save all the CMOS changes, only for Main Menu

Table 6-1: BIOS Navigation Keys

6.1.3 Getting Help

When **F1** is pressed a small help window describing the appropriate keys to use and the possible selections for the highlighted item appears. To exit the Help Window press **Esc** or the **F1** key again.

6.1.4 Unable to Reboot After Configuration Changes

If the computer cannot boot after changes to the system configuration is made, CMOS defaults. Use the jumper described in **Section 5.4**.

6.1.5 BIOS Menu Bar

The menu bar on top of the BIOS screen has the following main items:

- **Main** Changes the basic system configuration.
- **Advanced** Changes the advanced system settings.
- **PCIPnP** Changes the advanced PCI/PnP settings.
- **Boot** Changes the system boot configuration.
- **Security** Sets User and Supervisor Passwords.
- **Chipset** Changes the chipset settings.
- **Exit** Selects exit options and loads default settings

The following sections completely describe the configuration options found in the menu items at the top of the BIOS screen and listed above.

IMBA-9454G Motherboard

6.2 Main

The **Main** BIOS menu (BIOS Menu 1) appears when the BIOS Setup program is entered. The Main menu gives an overview of the basic system information.

```

BIOS SETUP UTILITY
Main  Advanced  PCIPnP  Boot  Security  Chipset  Exit

System Overview
-----
AMIBIOS
Version      :08.00.14
Build Date   :12/30/10
ID:          :B188MR14

Processor
Intel® Pentium® 4 CPU 3.20GHz
Speed       :3200MHz
Count       :1

System Memory
Size        :2040MB

System Time      [14:20:27]
System Date     [Tue 03/03/2011]

v02.61 ©Copyright 1985-2006, American Megatrends, Inc.

Use [ENTER], [TAB] or [SHIFT-TAB] to select a field.
Use [+] or [-] to configure system Time.

←→ Select Screen
↑↓ Select Item
+ - Change Field
Tab Select Field
F1  General Help
F10 Save and Exit
ESC Exit
    
```

BIOS Menu 1: Main

→ System Overview

The System Overview lists a brief summary of different system components. The fields in System Overview cannot be changed. The items shown in the system overview include:

- **AMI BIOS:** Displays auto-detected BIOS information
 - **Version:** Current BIOS version
 - **Build Date:** Date the current BIOS version was made
 - **ID:** Installed BIOS ID
- **Processor:** Displays auto-detected CPU specifications
 - **Speed:** Lists the processor speed
 - **Count:** The number of CPUs on the motherboard
- **System Memory:** Displays the auto-detected system memory.
 - **Size:** Lists memory size

The **System Overview** field also has two user configurable fields:

→ **System Time [xx:xx:xx]**

Use the System Time option to set the system time. Manually enter the hours, minutes and seconds.

→ **System Date [xx/xx/xx]**

Use the System Date option to set the system date. Manually enter the day, month and year.

6.3 Advanced

Use the **Advanced** menu (BIOS Menu 2) to configure the CPU and peripheral devices through the following sub-menus:



WARNING:

Setting the wrong values in the sections below may cause the system to malfunction. Make sure that the settings made are compatible with the hardware.

- **CPU Configuration**
- **IDE Configuration**
- **Floppy Configuration**
- **SuperIO Configuration**
- **Hardware Health Configuration**
- **Power Configuration**
- **Remote Access Configuration**
- **Trusted Computing**
- **USB Configuration**

IMBA-9454G Motherboard

```

BIOS SETUP UTILITY
Main  Advanced  PCIPnP  Boot  Security  Chipset  Exit
-----
Advanced Settings                                Configure CPU.
-----
WARNING: Setting wrong values in below sections may cause
system to malfunction

> CPU Configuration
> IDE Configuration
> Floppy Configuration
> SuperIO Configuration
> Hardware Health Configuration
> Power Configuration
> Remote Access Configuration
> Trusted Computing
> USB Configuration

<->  Select Screen
↑↓   Select Item
Enter Go to Sub Screen
F1   General Help
F10  Save and Exit
ESC  Exit

v02.61 ©Copyright 1985-2006, American Megatrends, Inc.

```

BIOS Menu 2: Advanced

6.3.1 CPU Configuration

Use the **CPU Configuration** menu (BIOS Menu 3) to view detailed CPU specifications and configure the CPU.

```

BIOS SETUP UTILITY
Main  Advanced  PCIPnP  Boot  Security  Chipset  Exit
-----
Configure advanced CPU Settings
Module Version: 3F.15
-----
Manufacturer :Intel
Intel® Pentium® 4 CPU 3.20GHz
Frequency    :3.20GHz
FSB Speed    :800MHz

Cache L1     :16KB
Cache L2     :2048KB

Ratio Actual Value:16

<->  Select Screen
↑↓   Select Item
F1   General Help
F10  Save and Exit
ESC  Exit

v02.61 ©Copyright 1985-2006, American Megatrends, Inc.

```

BIOS Menu 3: CPU Configuration

The CPU Configuration menu (BIOS Menu 3) lists the following CPU details:

- **Module Version:** xx.xx

- **Manufacturer:** Lists the name of the CPU manufacturer
- **Frequency:** Lists the CPU processing speed
- **FSB Speed:** Lists the FSB speed
- **Cache L1:** Lists the CPU L1 cache size
- **Cache L2:** Lists the CPU L2 cache size
- **Ratio Actual Value:** Displays the ratio at which the CPU is actually operating

6.3.2 IDE Configuration

Use the **IDE Configuration** menu (**BIOS Menu 4**) to change and/or set the configuration of the IDE devices installed in the system.

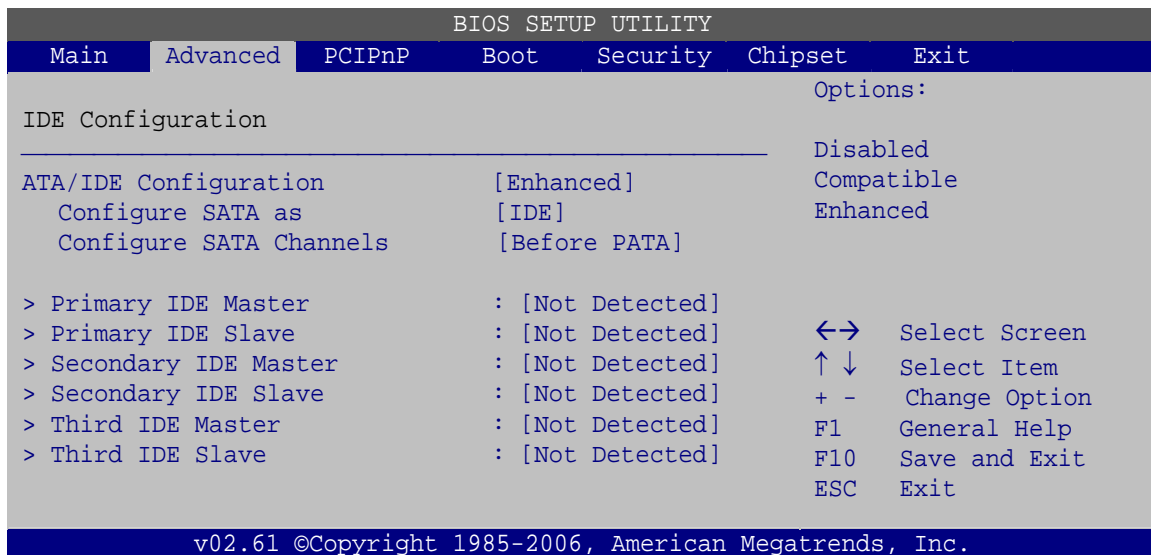

BIOS Menu 4: IDE Configuration

→ ATA/IDE Configurations [Enhanced]

Use the **ATA/IDE Configurations** option to configure the ATA/IDE controller.

- **Disabled** Disables the on-board ATA/IDE controller.
- **Compatible** Configures the on-board ATA/IDE controller to be in compatible mode. In this mode, a SATA channel will replace one of the IDE channels. This mode supports up to 4 storage devices.
- **Enhanced** **DEFAULT** Configures the on-board ATA/IDE controller to be in

IMBA-9454G Motherboard

Enhanced mode. In this mode, IDE channels and SATA channels are separated. This mode supports up to 6 storage devices. Some legacy OS do not support this mode.

→ Configure SATA as [IDE]

Use the **Configure SATA as** option to configure SATA devices as normal IDE devices.

→ **IDE** **DEFAULT** Configures SATA devices as normal IDE device.

→ Configure SATA Channels [Before PATA]

Use the **Configure SATA Channels** option to determine how SATA channels and PATA channels are ordered.

→ **Before PATA** **DEFAULT** Puts SATA channels before PATA channels.

→ **Behind PATA** Puts SATA channels behind PATA channels.

→ IDE (Master) and IDE (Slave)

When entering setup, BIOS auto detects the presence of IDE devices. BIOS displays the status of the auto detected IDE devices. The following IDE devices are detected and are shown in the IDE Configuration menu:

- Primary IDE Master
- Primary IDE Slave
- Secondary IDE Master
- Secondary IDE Slave
- Third IDE Master
- Third IDE Slave

The IDE Configuration menu (**BIOS Menu 4**) allows changes to the configurations for the IDE devices installed in the system. If an IDE device is detected, and one of the above listed BIOS configuration options are selected, the IDE configuration options shown in **Section 6.3.2.1** appear.

6.3.2.1 IDE Master, IDE Slave

Use the **IDE Master and IDE Slave** configuration menu (**BIOS Menu 5**) to view both primary and secondary IDE device details and configure the IDE devices connected to the system.

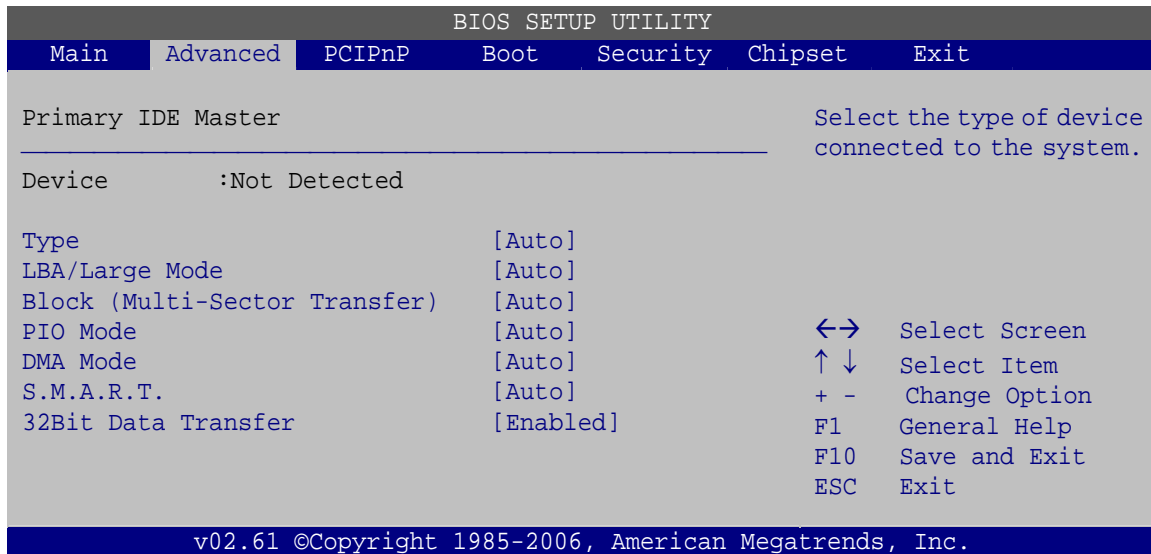

BIOS Menu 5: IDE Master and IDE Slave Configuration

→ Auto-Detected Drive Parameters

The drive parameters are listed as follows:

- **Device:** Lists the device type (e.g. hard disk, CD-ROM etc.)
- **Type:** Indicates the type of devices a user can manually select
- **LBA Mode:** Indicates whether the LBA (Logical Block Addressing) is a method of addressing data on a disk drive is supported or not.
- **Block Mode:** Block mode boosts IDE drive performance by increasing the amount of data transferred. Only 512 bytes of data can be transferred per interrupt if block mode is not used. Block mode allows transfers of up to 64 KB per interrupt.
- **PIO Mode:** Indicates the PIO mode of the installed device.
- **DMA Mode:** Adjust the DMA mode options.
- **S.M.A.R.T.:** Indicates whether or not the Self-Monitoring Analysis and Reporting Technology protocol is supported.
- **32Bit Data Transfer:** Enables 32-bit data transfer.

IMBA-9454G Motherboard

→ Type [Auto]

Use the Type BIOS option to select the type of device the AMIBIOS attempts to boot from after the Power-On Self-Test (POST) is complete.

- **Not Installed** BIOS is prevented from searching for an IDE disk drive on the specified channel.
- **Auto** **DEFAULT** The BIOS auto detects the IDE disk drive type attached to the specified channel. This setting should be used if an IDE hard disk drive is attached to the specified channel.
- **CD/DVD** The CD/DVD option specifies that an IDE CD-ROM drive is attached to the specified IDE channel. The BIOS does not attempt to search for other types of IDE disk drives on the specified channel.
- **ARMD** This option specifies an ATAPI Removable Media Device. These include, but are not limited to:
 - **ZIP**
 - **LS-120**

→ LBA/Large Mode [Auto]

Use the LBA/Large Mode option to disable or enable BIOS to auto detect LBA (Logical Block Addressing). LBA is a method of addressing data on a disk drive. In LBA mode, the maximum drive capacity is 137 GB.

- **Disabled** BIOS is prevented from using the LBA mode control on the specified channel.
- **Auto** **DEFAULT** BIOS auto detects the LBA mode control on the specified channel.

→ Block (Multi Sector Transfer) [Auto]

Use the Block (Multi Sector Transfer) to disable or enable BIOS to auto detect if the device supports multi-sector transfers.

→ Disabled BIOS is prevented from using Multi-Sector Transfer on the specified channel. The data to and from the device occurs one sector at a time.

→ Auto **DEFAULT** BIOS auto detects Multi-Sector Transfer support on the drive on the specified channel. If supported the data transfer to and from the device occurs multiple sectors at a time.

→ PIO Mode [Auto]

Use the PIO Mode option to select the IDE PIO (Programmable I/O) mode program timing cycles between the IDE drive and the programmable IDE controller. As the PIO mode increases, the cycle time decreases.

→ Auto **DEFAULT** BIOS auto detects the PIO mode. Use this value if the IDE disk drive support cannot be determined.

→ 0 PIO mode 0 selected with a maximum transfer rate of 3.3MBps

→ 1 PIO mode 1 selected with a maximum transfer rate of 5.2MBps

→ 2 PIO mode 2 selected with a maximum transfer rate of 8.3MBps

→ 3 PIO mode 3 selected with a maximum transfer rate of 11.1MBps

→ 4 PIO mode 4 selected with a maximum transfer rate of 16.6MBps
(This setting generally works with all hard disk drives manufactured after 1999. For other disk drives, such as IDE CD-ROM drives, check the specifications of the drive.)

→ DMA Mode [Auto]

Use the DMA Mode BIOS selection to adjust the DMA mode options.

IMBA-9454G Motherboard

→ **Auto** **DEFAULT** BIOS auto detects the DMA mode. Use this value if the IDE disk drive support cannot be determined.

→ **S.M.A.R.T [Auto]**

Use the S.M.A.R.T option to auto-detect, disable or enable Self-Monitoring Analysis and Reporting Technology (SMART) on the drive on the specified channel. S.M.A.R.T predicts impending drive failures. The S.M.A.R.T BIOS option enables or disables this function.

→ **Auto** **DEFAULT** BIOS auto detects HDD SMART support.

→ **Disabled** Prevents BIOS from using the HDD SMART feature.

→ **Enabled** Allows BIOS to use the HDD SMART feature

→ **32Bit Data Transfer [Enabled]**

Use the 32Bit Data Transfer BIOS option to enables or disable 32-bit data transfers.

→ **Disabled** Prevents the BIOS from using 32-bit data transfers.

→ **Enabled** **DEFAULT** Allows BIOS to use 32-bit data transfers on supported hard disk drives.

6.3.3 Floppy Configuration

Use the **Floppy Configuration** menu (**BIOS Menu 6**) to configure the floppy disk drive connected to the system.

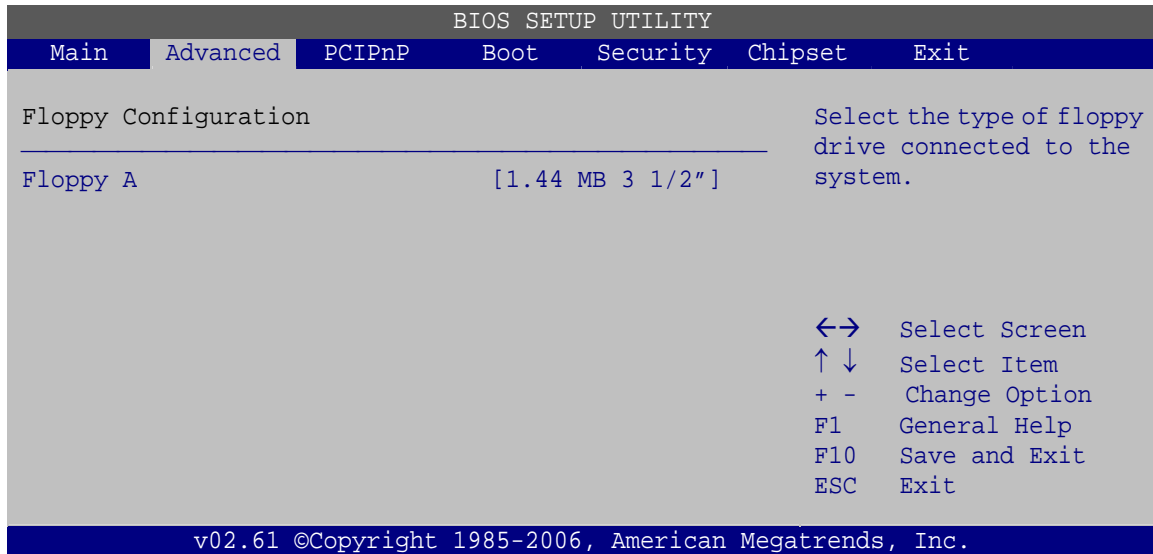

BIOS Menu 6: Floppy Configuration

→ Floppy A

Use the Floppy A option to configure the floppy disk drive. Options are listed below:

- Disabled
- 1.44 MB 3 1/2" **DEFAULT**

6.3.4 Super IO Configuration

Use the **Super IO Configuration** menu (BIOS Menu 7) to set or change the configurations for the FDD controllers, parallel ports and serial ports.

IMBA-9454G Motherboard

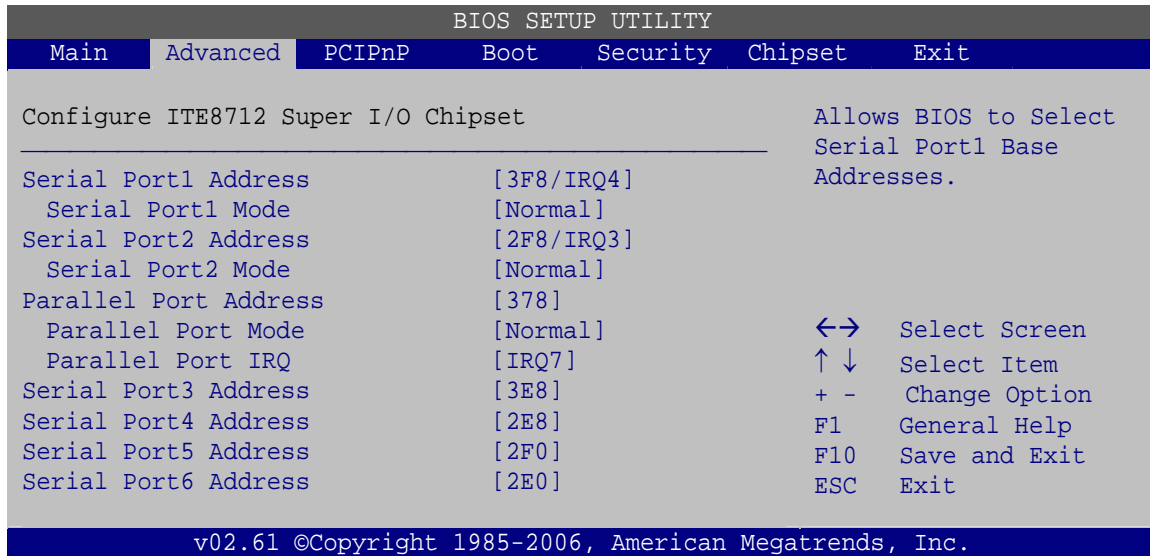

BIOS Menu 7: Super IO Configuration

→ Serial Port1 Address [3F8/IRQ4]

Use the Serial Port1 Address option to select the Serial Port 1 base address.

- **Disabled** No base address is assigned to Serial Port 1
- **3F8/IRQ4** **DEFAULT** Serial Port 1 I/O port address is 3F8 and the interrupt address is IRQ4
- **3E8/IRQ4** Serial Port 1 I/O port address is 3E8 and the interrupt address is IRQ4
- **2E8/IRQ3** Serial Port 1 I/O port address is 2E8 and the interrupt address is IRQ3

→ Serial Port1 Mode [Normal]

Use the Serial Port1 Mode option to select the Serial Port1 operational mode.

- **Normal** **DEFAULT** Serial Port 1 mode is normal
- **IrDA** Serial Port 1 mode is IrDA
- **ASK IR** Serial Port 1 mode is ASK IR

→ Serial Port2 Address [2F8/IRQ3]

Use the Serial Port2 Address option to select the Serial Port 2 base address.

- Disabled** No base address is assigned to Serial Port 2
- 2F8/IRQ3** **DEFAULT** Serial Port 2 I/O port address is 3F8 and the interrupt address is IRQ3
- 3E8/IRQ4** Serial Port 2 I/O port address is 3E8 and the interrupt address is IRQ4
- 2E8/IRQ3** Serial Port 2 I/O port address is 2E8 and the interrupt address is IRQ3

→ Serial Port2 Mode [Normal]

Use the Serial Port2 Mode option to select the Serial Port2 operational mode.

- Normal** **DEFAULT** Serial Port 2 mode is normal
- IrDA** Serial Port 2 mode is IrDA
- ASK IR** Serial Port 2 mode is ASK IR

→ Parallel Port Address [378]

Use the Parallel Port Address option to select the parallel port base address.

- Disabled** No base address is assigned to the Parallel Port
- 378** **DEFAULT** Parallel Port I/O port address is 378
- 278** Parallel Port I/O port address is 278
- 3BC** Parallel Port I/O port address is 3BC

→ Parallel Port Mode [Normal]

Use the Parallel Port Mode option to select the mode the parallel port operates in.

- Normal** **DEFAULT** The normal parallel port mode is the standard mode for parallel port operation.

→ Serial Port4 Address [2E8]

Use the **Serial Port4 IRQ** option to select the interrupt address for serial port 4.

- Disabled** No base address is assigned to serial port 3
- 3E8** Serial port 4 I/O port address is 3E8
- 2E8** **DEFAULT** Serial port 4 I/O port address is 2E8
- 2F0** Serial port 4 I/O port address is 2F0
- 2E0** Serial port 4 I/O port address is 2E0

→ Serial Port5 Address [2F0]

Use the **Serial Port5 IRQ** option to select the interrupt address for serial port 5.

- Disabled** No base address is assigned to serial port 5
- 3E8** Serial port 5 I/O port address is 3E8
- 2E8** Serial port 5 I/O port address is 2E8
- 2F0** **DEFAULT** Serial port 5 I/O port address is 2F0
- 2E0** Serial port 5 I/O port address is 2E0

→ Serial Port6 Address [2E0]

Use the **Serial Port6 IRQ** option to select the interrupt address for serial port 6.

- Disabled** No base address is assigned to serial port 6
- 3E8** Serial port 6 I/O port address is 3E8
- 2E8** Serial port 6 I/O port address is 2E8
- 2F0** Serial port 6 I/O port address is 2F0
- 2E0** **DEFAULT** Serial port 6 I/O port address is 2E0

IMBA-9454G Motherboard

6.3.5 Hardware Health Configuration

The **Hardware Health Configuration** menu (BIOS Menu 8) shows the operating temperature, fan speeds and system voltages.

```

BIOS SETUP UTILITY
Main  Advanced  PCIPnP  Boot  Security  Chipset  Exit
-----
Hardware Health Configuration
-----
CPU FAN Mode Setting          [Full On mode]
System FAN1 Mode Setting      [Full On mode]
System FAN2 Mode Setting      [Full On mode]
CPU Temperature                :34°C/93°F
System Temperature #1         :29°C/84°F
System Temperature #2         :25°C/77°F

CPU Fan                        :3260 RPM
System Fan1 Speed              :N/A
System Fan2 Speed              :N/A

CPU Core                       :1.200 V
DRAM Vcc                       :1.840 V
+3.30V                         :3.168 V
+5.00V                         :4.945 V
+12.0V                         :11.840 V
FSB Vcc +1.20V                 :1.168 V
+1.50V                         :1.488 V
3VDU                           :2.944 V
VBAT                           :3.344 V

CPU configuration mode
setting
If Enable Automatic
mode, CPU Fan will refer
to CPU Temperature.

←→ Select Screen
↑↓ Select Item
+ - Change Option
F1  General Help
F10 Save and Exit
ESC Exit

v02.61 ©Copyright 1985-2006, American Megatrends, Inc.
  
```

BIOS Menu 8: Hardware Health Configuration

→ CPU FAN Mode Setting [Full On mode]

Use the **CPU FAN Mode Setting** to set the CPU fan mode.

- **Full On** **DEFAULT** Fan is on all the time.
mode
- **Automatic** The fan adjusts its speed using these settings:
Temp. Limit of OFF
Temp. Limit of Start
Fan Start PWM

Slope PWM 1

→ **System FAN1 Mode Setting [Full On Mode]**

Use the **System FAN1 Mode Setting** option to configure the first system fan.

- **Full On Mode** **DEFAULT** Fan is on all the time
- **Automatic mode** Fan is off when the temperature is low enough.
Parameters must be set by the user.

→ **System FAN2 Mode Setting [Full On Mode]**

Use the **System FAN2 Mode Setting** option to configure the second system fan.

- **Full On Mode** **DEFAULT** Fan is on all the time
- **Automatic mode** Fan is off when the temperature is low enough.
Parameters must be set by the user.

The following system parameters and values are shown. The system parameters that are monitored are:

- **System Temperatures:** The following system temperatures are monitored:
 - CPU Temperature
 - System Temperature #1
 - System Temperature #2
- **Fan Speeds:** The following cooling fan speeds are monitored:
 - CPU Fan
 - System Fan1 Speed
 - System Fan2 Speed
- **Voltages:** The following system voltages are monitored
 - CPU Core
 - DRAM Vcc
 - +3.30V
 - +5.00V
 - +12V
 - FSB Vcc +1.20V

IMBA-9454G Motherboard

- +1.50V
- 3V_{DU}
- V_{BAT}

6.3.6 Power Configuration

The **Power Configuration** menu (BIOS Menu 9) contains the ACPI and APM Configuration submenus.

```

BIOS SETUP UTILITY
Main  Advanced  PCIPnP  Boot  Security  Chipset  Exit
> ACPI Configuration      Section for Advanced
> APM Configuration      ACPI Configuration.

                                  ←→  Select Screen
                                  ↑↓  Select Item
                                  Enter Go to Sub Screen
                                  F1   General Help
                                  F10  Save and Exit
                                  ESC  Exit

v02.61 ©Copyright 1985-2006, American Megatrends, Inc.

```

BIOS Menu 9: Power Configuration

6.3.6.1 ACPI Configuration

Use the **ACPI Configuration** menu (**BIOS Menu 10**) to select the ACPI state when the system is suspended.

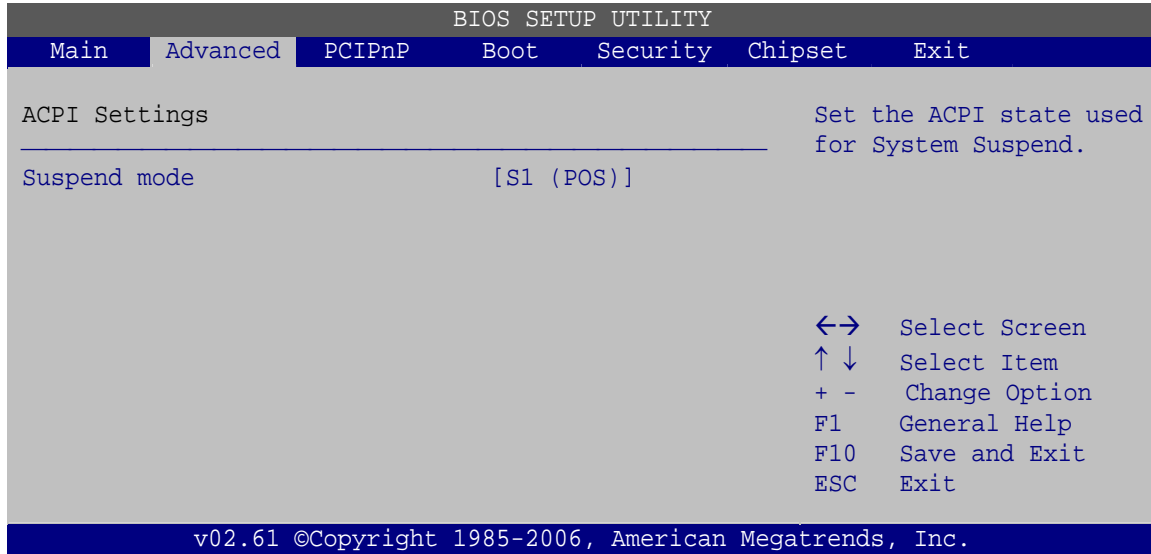

BIOS Menu 10: ACPI Configuration

→ Suspend Mode [S1 (POS)]

Use the Suspend Mode option to specify the sleep state the system enters when it is not being used.

- **S1 (POS) DEFAULT** The system enters S1 (POS) sleep state. The system appears off. The CPU is stopped; RAM is refreshed; the system is running in a low power mode.
- **S3 (STR)** The system enters a S3 (STR) sleep state. The CPU has no power; RAM is in slow refresh; the power supply is in a reduced power mode.

6.3.6.2 APM Configuration

The **APM Configuration** menu (**BIOS Menu 11**) allows the advanced power management options to be configured.

IMBA-9454G Motherboard

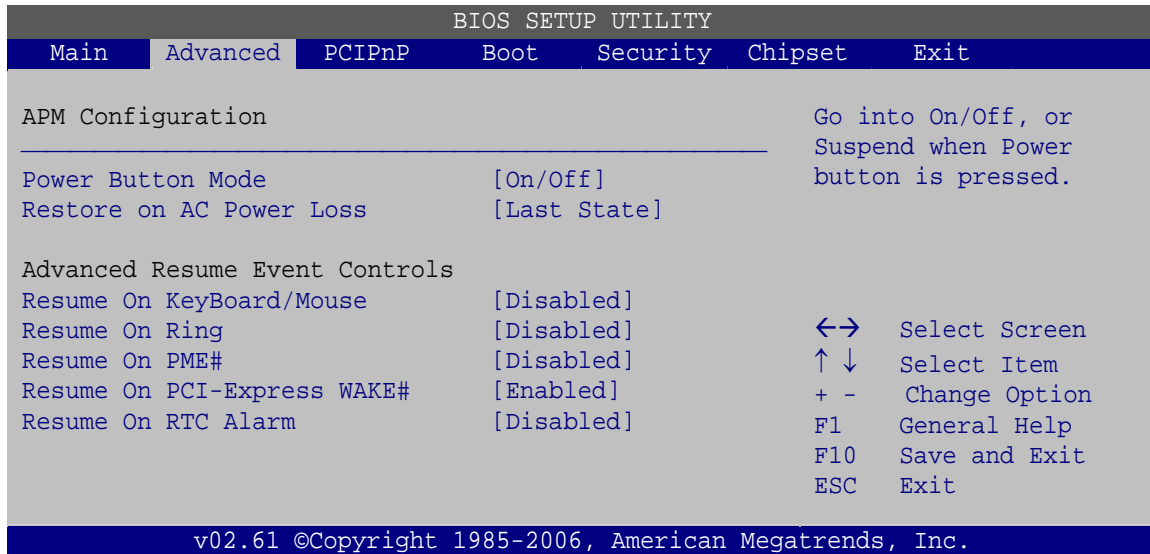

BIOS Menu 11: APM Configuration

→ Power Button Mode [On/Off]

Use the **Power Button Mode** BIOS to specify how the power button functions.

- **On/Off** **DEFAULT** When the power button is pressed the system is either turned on or off
- **Suspend** When the power button is pressed the system goes into suspend mode

→ Restore on AC Power Loss [Last State]

Use the **Restore on AC Power Loss** BIOS option to specify what state the system returns to if there is a sudden loss of power to the system.

- **Power Off** The system remains turned off.
- **Power On** The system turns on.
- **Last State** **DEFAULT** The system returns to its previous state. If it was on, it turns itself on. If it was off, it remains off.

→ Resume on KeyBoard/Mouse [Disabled]

Use the **Resume on Keyboard/Mouse** BIOS option to enable activity on either the keyboard or mouse to rouse the system from a suspend or standby state. That is, the system is roused when the mouse is moved or a button on the keyboard is pressed.

- **Disabled** **DEFAULT** Wake event not generated by activity on the keyboard or mouse
- **Resume On KeyBoard** Wake event generated by activity on the keyboard
- **Resume On Mouse** Wake event generated by activity on the mouse
- **Enabled** Wake event generated by activity on the keyboard or mouse

→ Resume on Ring [Disabled]

Use the **Resume on Ring** BIOS option to enable activity on the RI (ring in) modem line to rouse the system from a suspend or standby state. That is, the system will be roused by an incoming call on a modem.

- **Disabled** **DEFAULT** Wake event not generated by an incoming call
- **Enabled** Wake event generated by an incoming call

→ Resume on PME# [Disabled]

Use the **Resume on PME#** BIOS option to enable activity on the PCI PME (power management event) controller to rouse the system from a suspend or standby state.

- **Disabled** **DEFAULT** Wake event not generated by PCI PME controller activity
- **Enabled** Wake event generated by PCI PME controller activity

IMBA-9454G Motherboard

→ Resume on PCI-Express WAKE# [Enabled]

The **Resume on PCI-Express WAKE#** BIOS option specifies if the system is roused from a suspended or standby state when there is activity on the PCI-Express bus.

- **Disabled** Wake event not generated by PCI-Express activity
- **Enabled** **DEFAULT** Wake event generated by PCI-Express activity

→ Resume On RTC Alarm [Disabled]

Use the **Resume On RTC Alarm** option to specify the time the system should be roused from a suspended state.

- **Disabled** **DEFAULT** The real time clock (RTC) cannot generate a wake event
- **Enabled** If selected, the following appears with values that can be selected:

→ RTC Alarm Date (Days)

→ System Time

After setting the alarm, the computer turns itself on from a suspend state when the alarm goes off.

6.3.7 Remote Access Configuration

Use the **Remove Access Configuration** menu (**BIOS Menu 12**) to configure remote access parameters. The **Remote Access Configuration** is an AMIBIOS feature and allows a remote host running a terminal program to display and configure the BIOS settings.

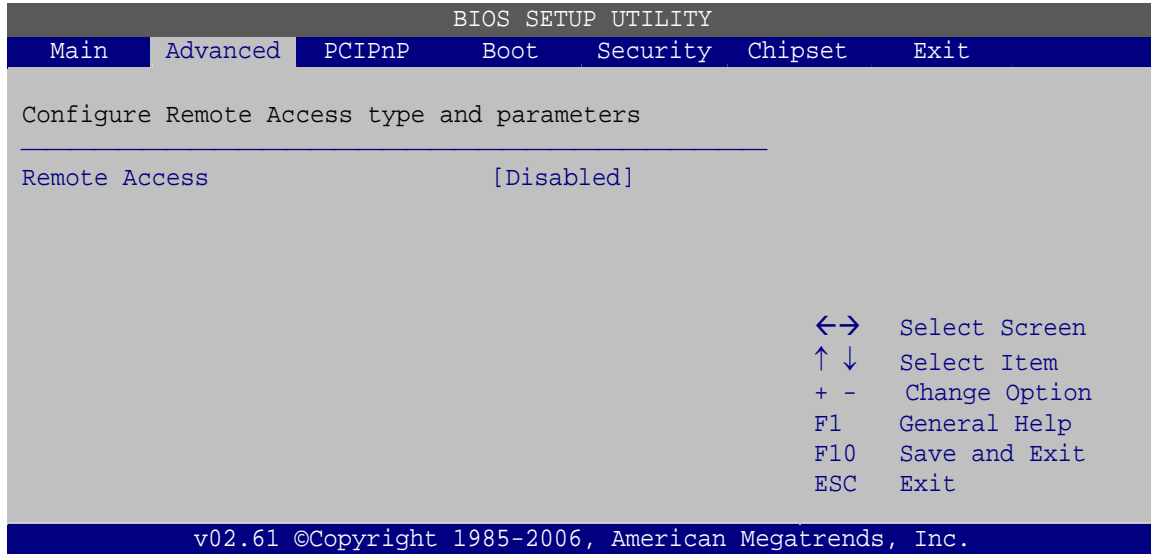

BIOS Menu 12: Remote Access Configuration

→ Remote Access [Disabled]

Use the **Remote Access** BIOS option to enable or disable access to the remote functionalities of the system.

- **Disabled** **DEFAULT** Remote access is disabled.
- **Enabled** Remote access configuration options shown below appear:
 - Serial Port Number
 - Serial Port Mode
 - Redirection after BIOS POST
 - Terminal Type
 These configuration options are discussed below.

→ Serial port number [COM1]

Use the **Serial Port Number** option to select the serial port used for remote access.

- **COM1** **DEFAULT** System is remotely accessed through COM1
- **COM2** **DEFAULT** System is remotely accessed through COM2

IMBA-9454G Motherboard

- **COM3** **DEFAULT** System is remotely accessed through COM3
- **COM4** **DEFAULT** System is remotely accessed through COM4
- **COM5** **DEFAULT** System is remotely accessed through COM5
- **COM6** **DEFAULT** System is remotely accessed through COM6

NOTE: Make sure the selected COM port is enabled through the Super I/O configuration menu.

→ **Base Address, IRQ [3F8h, 4]**

The **Base Address, IRQ** option cannot be configured and only shows the interrupt address of the serial port listed above.

→ **Serial Port Mode [115200 8,n,1]**

Use the **Serial Port Mode** option to select baud rate through which the console redirection is made. The following configuration options are available.

- 115200 8,n,1 **DEFAULT**
- 57600 8,n,1
- 38400 8,n,1
- 19200 8,n,1
- 09600 8,n,1



NOTE:

Identical baud rate settings must be set on the host (a management computer running terminal software) and the slave.

→ **Redirection After BIOS POST [Always]**

Use the **Redirection After BIOS POST** option to specify when console redirection should occur.

- **Disabled** The console is not redirected after POST.

- **Boot Loader** Redirection is active during POST and during Boot Loader
- **Always** **DEFAULT** Redirection is always active (Some OSES may not work if set to Always)

→ **Terminal Type [ANSI]**

Use the **Terminal Type** BIOS option to specify the remote terminal type.

- **ANSI** **DEFAULT** The target terminal type is ANSI
- **VT100** The target terminal type is VT100
- **VT-UTF8** The target terminal type is VT-UTF8

6.3.8 Trusted Computing

Use the **Trusted Computing** menu (**BIOS Menu 13**) to configure settings related to the Trusted Computing Group (TCG) Trusted Platform Module (TPM).

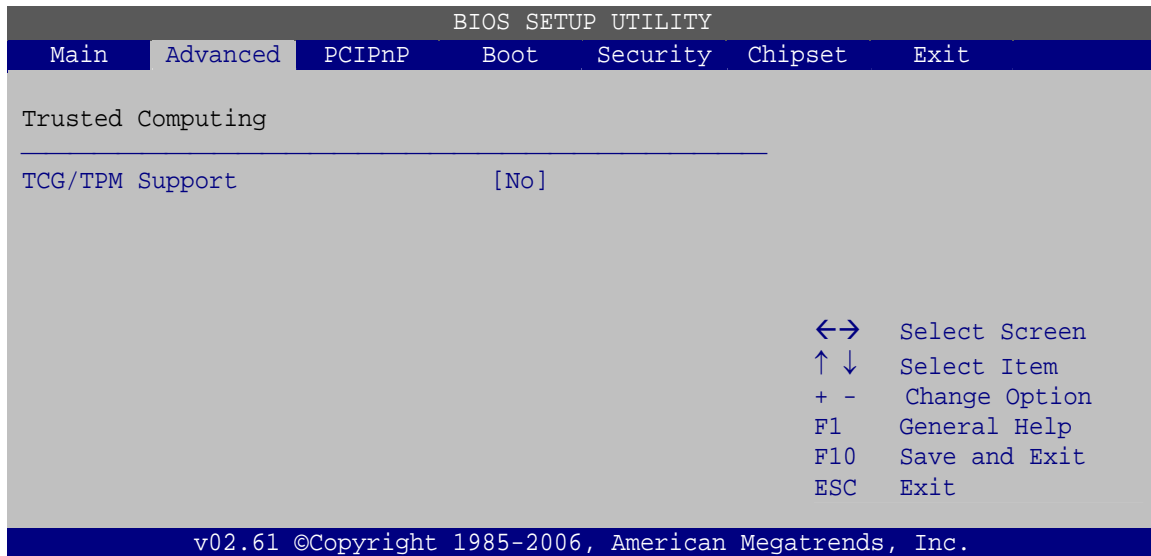

BIOS Menu 13: Trusted Computing

→ **TCG/TPM Support [No]**

Use the **TCG/TPM Support** option to configure support for the TPM.

IMBA-9454G Motherboard

- ➔ **No** **DEFAULT** TPM support is disabled.
- ➔ **Yes** TPM support is enabled.

6.3.9 USB Configuration

Use the **USB Configuration** menu (**BIOS Menu 14**) to read USB configuration information and configure the USB settings.

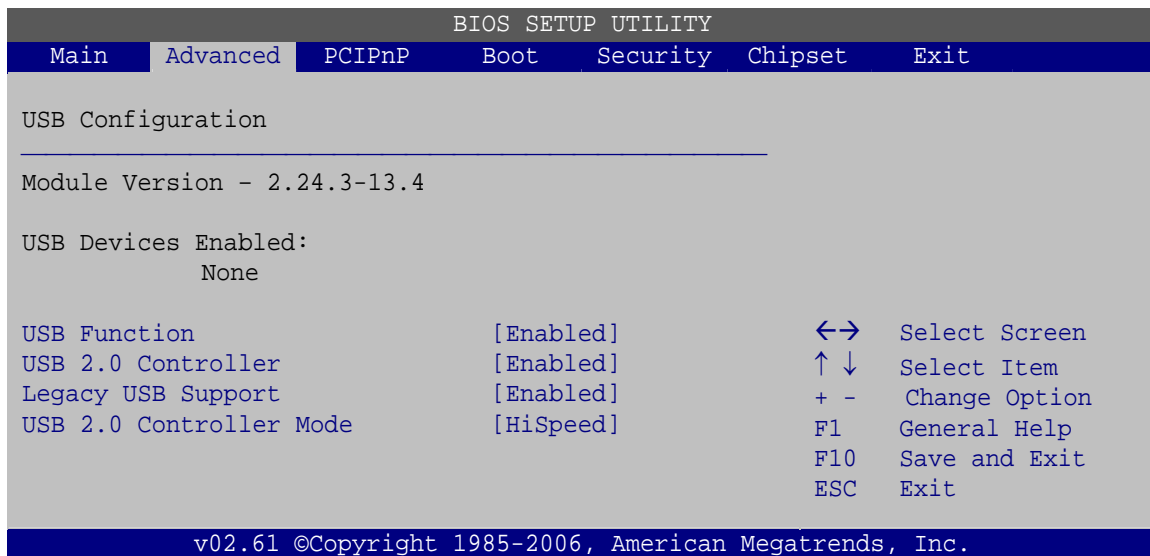

BIOS Menu 14: USB Configuration

➔ USB Configuration

The USB Configuration field shows the system USB configuration. The items listed are:

- Module Version: x.xx.x-xx.x

➔ USB Function [Enabled]

Use the USB Function BIOS option to enable or disable the USB ports.

- ➔ **Disabled** USB function support disabled
- ➔ **Enabled** **DEFAULT** USB function support enabled

→ USB 2.0 Controller [Enabled]

Use the USB 2.0 Controller BIOS option to enable or disable the USB 2.0 controller

- Disabled** USB 2.0 controller disabled
- Enabled** **DEFAULT** USB 2.0 controller enabled

→ Legacy USB Support [Enabled]

Use the Legacy USB Support BIOS option to enable USB mouse and USB keyboard support.

Normally if this option is not enabled, any attached USB mouse or USB keyboard does not become available until a USB compatible operating system is fully booted with all USB drivers loaded. When this option is enabled, any attached USB mouse or USB keyboard can control the system even when there is no USB driver loaded onto the system.

- Disabled** Legacy USB support disabled
- Enabled** **DEFAULT** Legacy USB support enabled
- Auto** Legacy USB support disabled if no USB devices are connected

→ USB2.0 Controller Mode [HiSpeed]

The **USB 2.0 Controller Mode** BIOS option sets the speed of the USB 2.0 controller.

- FullSpeed** The controller is capable of operating at full speed (12Mbits/second)
- HiSpeed** **DEFAULT** The controller is capable of operating at high speed (480Mbits/second)

6.4 PCI/PnP

Use the PCI/PnP menu (**BIOS Menu 15**) to configure advanced PCI and PnP settings.

IMBA-9454G Motherboard



WARNING:

Setting wrong values for the BIOS selections in the PCIPnP BIOS menu may cause the system to malfunction.

```

BIOS SETUP UTILITY
Main  Advanced  PCIPnP  Boot  Security  Chipset  Exit
-----
Advanced PCI/PnP Settings
-----
WARNING: Setting wrong values in below sections
         may cause system to malfunction

IRQ3           [Reserved]
IRQ4           [Reserved]
IRQ5           [Available]
IRQ7           [Available]
IRQ9           [Available]
IRQ10          [Available]
IRQ11          [Reserved]
IRQ14          [Available]
IRQ15          [Available]

DMA Channel 0  [Available]
DMA Channel 1  [Available]
DMA Channel 3  [Available]
DMA Channel 5  [Available]
DMA Channel 6  [Available]
DMA Channel 7  [Available]

Reserved Memory Size  [Disable]

Available: Specified IRQ
is available to be used
by PCI/PnP devices.
Reserved: Specified IRQ
is reserved for use by
Legacy ISA devices.

←→  Select Screen
↑↓  Select Item
+ -  Change Option
F1   General Help
F10  Save and Exit
ESC  Exit

v02.61 ©Copyright 1985-2006, American Megatrends, Inc.
  
```

BIOS Menu 15: PCI/PnP Configuration

→ IRQ#

Use the **IRQ#** address to specify what IRQs can be assigned to a particular peripheral device.

- **Available** The specified IRQ is available to be used by PCI/PnP devices
- **Reserved** The specified IRQ is reserved for use by Legacy ISA devices

Available IRQ addresses are:

- IRQ3
- IRQ4
- IRQ5
- IRQ7
- IRQ9
- IRQ10
- IRQ 11
- IRQ 14
- IRQ 15

→ **DMA Channel#**

Use the **DMA Channel#** option to assign a specific DMA channel to a particular PCI/PnP device.

- **Available** The specified DMA is available to be used by PCI/PnP devices
- **Reserved** The specified DMA is reserved for use by Legacy ISA devices

Available DMA Channels are:

- DM Channel 0
- DM Channel 1
- DM Channel 3
- DM Channel 5
- DM Channel 6
- DM Channel 7

→ **Reserved Memory Size [Disabled]**

Use the **Reserved Memory Size** BIOS option to specify the amount of memory that should be reserved for legacy ISA devices.

- **Disabled** **DEFAULT** No memory block reserved for legacy ISA devices

IMBA-9454G Motherboard

- ➔ 16K 16 KB reserved for legacy ISA devices
- ➔ 32K 32 KB reserved for legacy ISA devices
- ➔ 64K 54 KB reserved for legacy ISA devices

6.5 Boot

Use the **Boot** menu (**BIOS Menu 16**) to configure system boot options.

```

BIOS SETUP UTILITY
Main  Advanced  PCIPnP  Boot  Security  Chipset  Exit
-----
Boot Settings                                Configure Settings
                                             during System Boot.
-----
> Boot Settings Configuration

> Boot Device Priority
> Removable Drives

                                  ←→  Select Screen
                                  ↑↓  Select Item
                                  Enter Go to Sub Screen
                                  F1   General Help
                                  F10  Save and Exit
                                  ESC  Exit

v02.61 ©Copyright 1985-2006, American Megatrends, Inc.
  
```

BIOS Menu 16: Boot

6.5.1 Boot Settings Configuration

Use the **Boot Settings Configuration** menu (**BIOS Menu 17**) to configure advanced system boot options.

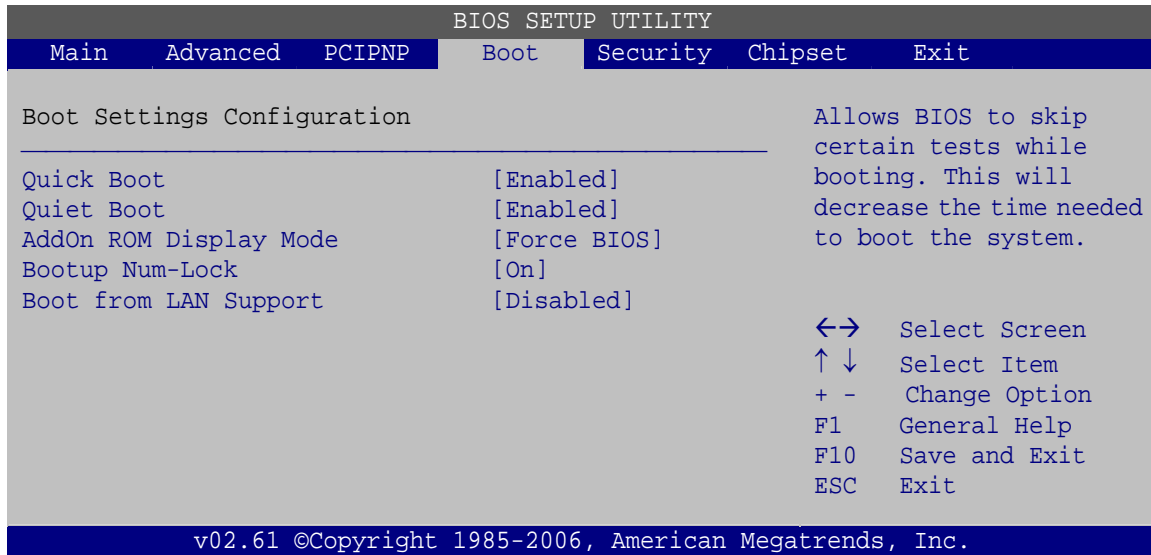

BIOS Menu 17: Boot Settings Configuration

→ Quick Boot [Enabled]

Use the **Quick Boot** BIOS option to make the computer speed up the boot process.

- **Disabled** No POST procedures are skipped
- **Enabled** **DEFAULT** Some POST procedures are skipped to decrease the system boot time

→ Quiet Boot [Disabled]

Use the **Quiet Boot** BIOS option to select the screen display when the system boots.

- **Disabled** **DEFAULT** Normal POST messages displayed
- **Enabled** OEM Logo displayed instead of POST messages

IMBA-9454G Motherboard

→ AddOn ROM Display Mode [Force BIOS]

Use the **AddOn ROM Display Mode** option to allow add-on ROM (read-only memory) messages to be displayed.

- **Force BIOS** **DEFAULT** The system forces third party BIOS to display during system boot.
- **Keep Current** The system displays normal information during system boot.

→ Bootup Num-Lock [On]

Use the **Bootup Num-Lock** BIOS option to specify if the number lock setting must be modified during boot up.

- **Off** Does not enable the keyboard Number Lock automatically. To use the 10-keys on the keyboard, press the Number Lock key located on the upper left-hand corner of the 10-key pad. The Number Lock LED on the keyboard lights up when the Number Lock is engaged.
- **On** **DEFAULT** Allows the Number Lock on the keyboard to be enabled automatically when the computer system boots up. This allows the immediate use of the 10-key numeric keypad located on the right side of the keyboard. To confirm this, the Number Lock LED light on the keyboard is lit.

→ Boot From LAN Support [Disabled]

The **Boot From LAN Support** option enables the system to be booted from a remote system.

- **Disabled** **DEFAULT** Cannot be booted from a remote system through the LAN
- **Enabled** Can be booted from a remote system through the LAN

6.5.2 Boot Device Priority

Use the **Boot Device Priority** menu (**BIOS Menu 18**) to specify the boot sequence from the available devices. The drive sequence also depends on the boot sequence in the individual device section.

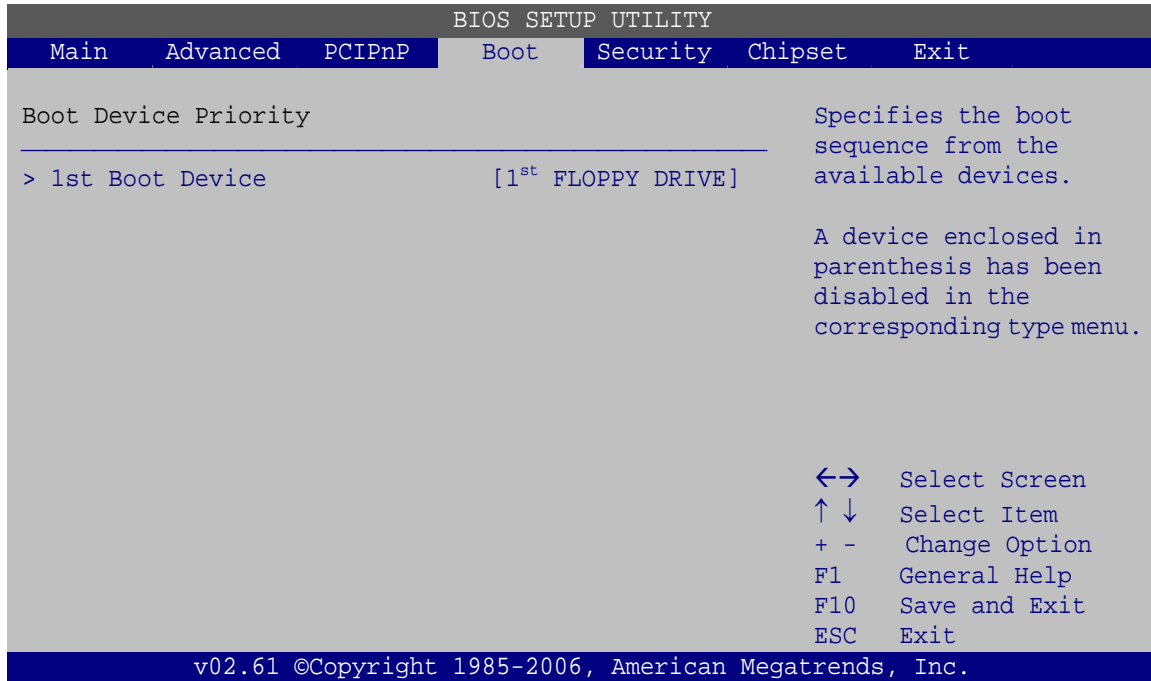

BIOS Menu 18: Boot Device Priority Settings

6.5.3 Removable Drives

Use the Removable Drives menu (**BIOS Menu 19**) to specify the boot sequence of the available FDDs. When the menu is opened, the FDDs connected to the system are listed as shown below:

- 1st Drive [1st FLOPPY DRIVE]



NOTE:

Only the drives connected to the system are shown. For example, if only one FDD is connected only "**1st Drive**" is listed.

IMBA-9454G Motherboard

The boot sequence from the available devices is selected. If the “1st Drive” option is selected a list of available FDDs is shown. Select the first FDD the system boots from. If the “1st Drive” is not used for booting this option may be disabled.

```

BIOS SETUP UTILITY
Main  Advanced  PCIPnP  Boot  Security  Chipset  Exit
-----
Hard Disk Drives
-----
> 1st Drive          [1st FLOPPY DRIVE]
-----
Specifies the boot
sequence from the
available devices.

<=>  Select Screen
↑↓   Select Item
+ -  Change Option
F1   General Help
F10  Save and Exit
ESC  Exit

v02.61 ©Copyright 1985-2006, American Megatrends, Inc.

```

BIOS Menu 19: Removable Drives

6.6 Security

Use the Security menu (BIOS Menu 20) to set system and user passwords.

```

BIOS SETUP UTILITY
Main  Advanced  PCIPnP  Boot  Security  Chipset  Exit
-----
Security Settings
-----
Install or Change the
password.

Supervisor Password  :Not Installed
User Password        :Not Installed

Change Supervisor Password
Change User Password

<=>  Select Screen
↑↓   Select Item
Enter Change
F1   General Help
F10  Save and Exit
ESC  Exit

v02.61 ©Copyright 1985-2006, American Megatrends, Inc.

```

BIOS Menu 20: Security

→ Change Supervisor Password

Use the Change Supervisor Password to set or change a supervisor password. The default for this option is Not Installed. If a supervisor password must be installed, select this field and enter the password. After the password has been added, Install appears next to Change Supervisor Password.

→ Change User Password

Use the Change User Password to set or change a user password. The default for this option is Not Installed. If a user password must be installed, select this field and enter the password. After the password has been added, Install appears next to Change User Password.

6.7 Chipset

Use the **Chipset** menu (BIOS Menu 21) to access the NorthBridge and SouthBridge configuration menus.

**WARNING:**

Setting the wrong values for the Chipset BIOS selections in the Chipset BIOS menu may cause the system to malfunction.

IMBA-9454G Motherboard

```

BIOS SETUP UTILITY
Main  Advanced  PCIPnP  Boot  Security  Chipset  Exit
-----
Advanced Chipset Settings
-----
WARNING: Setting wrong values in below section
         may cause system to malfunction.

> Northbridge Configuration
> Southbridge Configuration

                                  ←→  Select Screen
                                  ↑↓  Select Item
                                  Enter Go to Sub Screen
                                  F1   General Help
                                  F10  Save and Exit
                                  ESC  Exit

v02.61 ©Copyright 1985-2006, American Megatrends, Inc.

```

BIOS Menu 21: Chipset

6.7.1 NorthBridge Configuration

Use the NorthBridge Configuration menu (**BIOS Menu 22**) to configure the Northbridge chipset.

```

BIOS SETUP UTILITY
Main  Advanced  PCIPnP  Boot  Security  Chipset  Exit
-----
Northbridge Configuration
-----
Memory Hole                               [Disabled]

Initate Graphic Adapter                   [PEG/PCI]
Internal Graphics Mode Select              [Enabled, 8MB]

DVMT Mode Select                           [DVMT Mode]
  DVMT/FIXED Memory                        [Maximum DVMT]

                                  ←→  Select Screen
                                  ↑↓  Select Item
                                  + -  Change Option
                                  F1   General Help
                                  F10  Save and Exit
                                  ESC  Exit

v02.61 ©Copyright 1985-2006, American Megatrends, Inc.

```

BIOS Menu 22:Northbridge Chipset Configuration

➔ **Memory Hole [Disabled]**

Use the **Memory Hole** option to reserve memory space between 15MB and 16MB for ISA expansion cards that require a specified area of memory to work properly. If an older ISA expansion card is used, please refer to the documentation that came with the card to see if it is necessary to reserve the space.

- ➔ **Disabled** **DEFAULT** Memory is not reserved for ISA expansion cards
- ➔ **15MB – 16MB** Between 15MB and 16MB of memory is reserved for ISA expansion cards

➔ **Initiate Graphic Adapter**

Use the **Initiate Graphic Adapter** option to select the graphics controller used as the primary boot device. Select either an integrated graphics controller (IGD) or a combination of PCI graphics controller, a PCI express (PEG) controller or an IGD. Configuration options are listed below:

- IGD
- PCI/IGD
- PCI/PEG
- PEG/IGD
- PEG/PCI **DEFAULT**

➔ **Internal Graphics Mode Select [Enable, 8MB]**

Use the **Internal Graphics Mode Select** option to specify the amount of system memory that can be used by the Internal graphics device.

- ➔ **Disable**
- ➔ **Enable, 1MB** 1MB of memory used by internal graphics device
- ➔ **Enable, 8MB** **DEFAULT** 8MB of memory used by internal graphics device

➔ **DVMT Mode Select [DVMT Mode]**

Use the **DVMT Mode Select** option to select the Intel Dynamic Video Memory Technology (DVMT) operating mode.

IMBA-9454G Motherboard

- ➔ **Fixed Mode** A fixed portion of graphics memory is reserved as graphics memory.
- ➔ **DVMT Mode** **DEFAULT** Graphics memory is dynamically allocated according to the system and graphics needs.
- ➔ **Combo Mode** A fixed portion of graphics memory is reserved as graphics memory. If more memory is needed, graphics memory is dynamically allocated according to the system and graphics needs.

➔ **DVMT/FIXED Memory [128 MB]**

Use the **DVMT/FIXED Memory** option to specify the maximum amount of memory that can be allocated as graphics memory. This option can only be configured if **DVMT Mode** or **Fixed Mode** is selected in the **DVMT Mode Select** option. If **Combo Mode** is selected, the maximum amount of graphics memory is 128 MB. Configuration options are listed below.

- 64 MB
- 128 MB
- Maximum DVMT Default

6.7.2 SouthBridge Configuration

Use the **Southbridge Configuration** menu (**BIOS Menu 23**) to configure the Southbridge chipset.

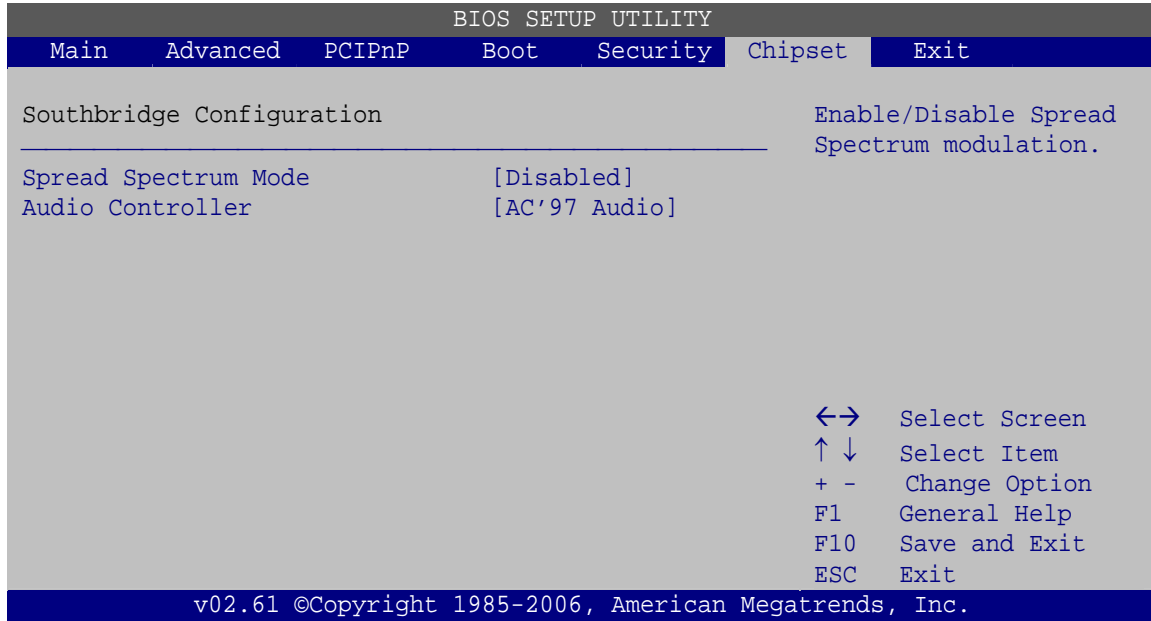

BIOS Menu 23: Southbridge Chipset Configuration

➔ Spread Spectrum Mode [Disabled]

Use the **Spread Spectrum** option to reduce the EMI. Excess EMI is generated when the system clock generator pulses have extreme values. Spreading the pulse spectrum modulates changes in the extreme values from spikes to flat curves, thus reducing the EMI. This benefit may in some cases be outweighed by problems with timing-critical devices, such as a clock-sensitive SCSI device.

- ➔ **Disabled** **DEFAULT** EMI not reduced
- ➔ **Enabled** EMI reduced

➔ Audio Controller [AC'97 Audio]

Use the Audio Controller option to enable or disable the AC'97 CODEC.

- ➔ **AC'97 Audio** **DEFAULT** The onboard AC'97 is disabled
- ➔ **All Disabled** The onboard AC'97 automatically detected and enabled

IMBA-9454G Motherboard

6.8 Exit

Use the **Exit** menu (BIOS Menu 24) to load default BIOS values, optimal failsafe values and to save configuration changes.

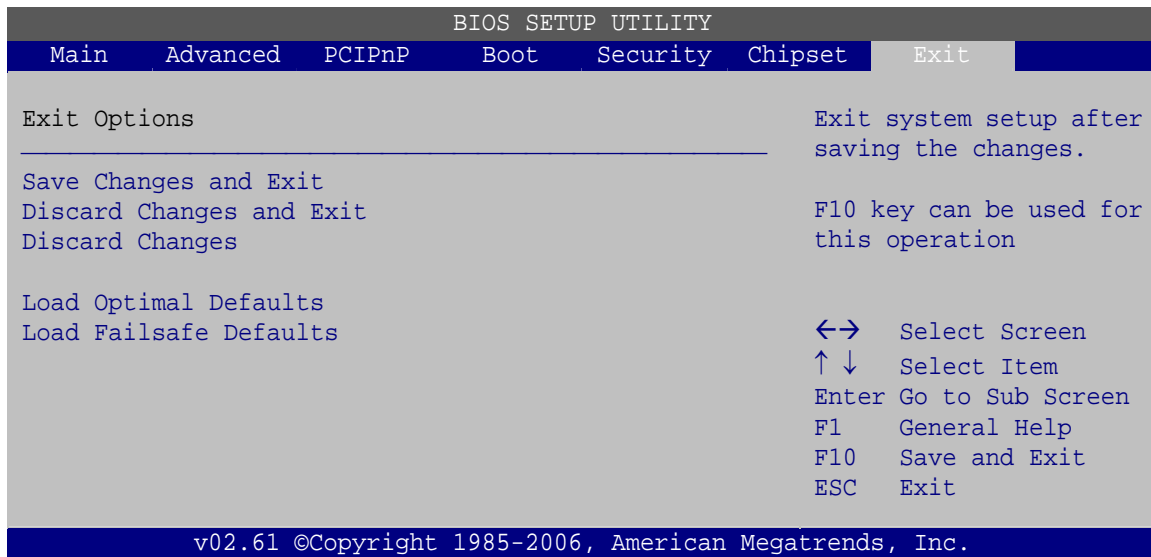

BIOS Menu 24: Exit

→ Save Changes and Exit

Use the Save Changes and Exit option to save the changes made to the BIOS options and to exit the BIOS configuration setup program.

→ Discard Changes and Exit

Use the Discard Changes and Exit option to exit the BIOS configuration setup program without saving the changes made to the system.

→ Discard Changes

Use the Discard Changes option to discard the changes and remain in the BIOS configuration setup program.

→ Load Optimal Defaults

Use the Load Optimal Defaults option to load the optimal default values for each of the parameters on the Setup menus. F9 key can be used for this operation.

→ Load Failsafe Defaults

Use the Load Failsafe Defaults option to load failsafe default values for each of the parameters on the Setup menus. F8 key can be used for this operation.

Chapter

7

Driver Installation

IMBA-9454G Motherboard

7.1 Available Software Drivers



NOTE:

The content of the CD may vary throughout the life cycle of the product and is subject to change without prior notice. Visit the IEI website or contact technical support for the latest updates.

The following drivers can be installed on the system:

- Chipset
- Intel® Graphics Media Accelerator
- Realtek LAN (for GbE LAN) driver
- Realtek AC '97 Audio driver

Installation instructions are given below.

7.2 Driver CD Auto-run

All the drivers for the IMBA-9454G are on the CD that came with the system. To install the drivers, please follow the steps below.

Step 1: Insert the CD into a CD drive connected to the system.



NOTE:

If the system does not initiate the "autorun" program when the CD is inserted, click the **Start** button, select **Run**, then type **X:\autorun.exe** (where **X:** is the system CD drive) to access the IEI Driver CD main menu.

Step 2: The driver main menu appears (Figure 7-1).

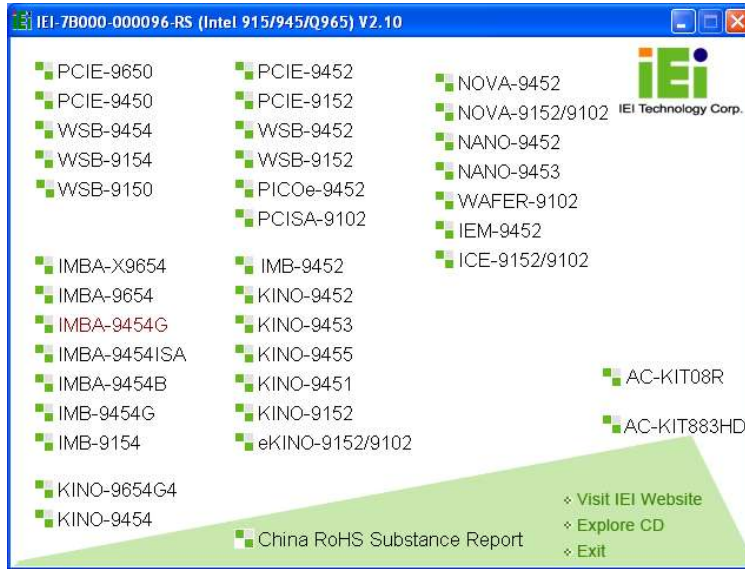

Figure 7-1: Introduction Screen

Step 3: Click IMBA-9454G.

Step 4: A new screen with a list of available drivers appears (Figure 7-2).

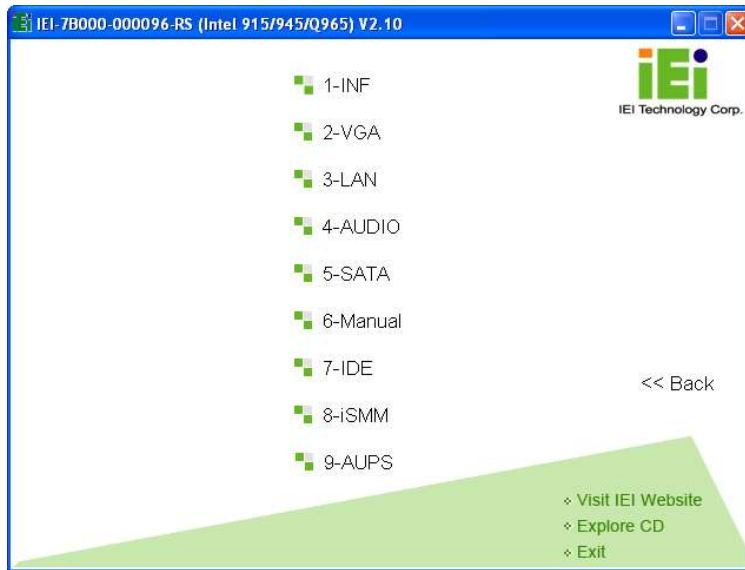

Figure 7-2: Available Drivers

Step 5: Select the driver to install from the list in **Figure 7-2**. Detailed driver installation instructions follow below.

IMBA-9454G Motherboard

7.3 Chipset Driver Installation

To install the chipset driver, please follow the steps below.

Step 1: Select **INF** from the list in **Figure 7-2**.

Step 2: A new window opens (Figure 7-3).



Figure 7-3: Chipset Driver Installation Program

Step 3: Double-click the **infinst_Autol.exe** icon.

Step 4: The welcome screen in **Figure 7-4** appears.



Figure 7-4: Chipset Driver Installation Welcome Screen

Step 5: Click **NEXT** to continue the installation process.

Step 6: The license agreement in Figure 7-5 appears.

**Figure 7-5: Chipset Driver Installation License Agreement**

Step 7: Read the license agreement. To accept the terms and conditions stipulated in the agreement, click **YES**.

Step 8: The Readme file in Figure 7-6 appears.



Figure 7-6: Chipset Driver Readme File Information

Step 9: Read the Readme file information and then click **NEXT** to start the driver installation.

Step 10: After the driver installation process is complete, a confirmation screen appears (Figure 7-7).



Figure 7-7: Chipset Driver Installation Complete

Step 11: Click **FINISH** to complete the driver installation.

7.4 Intel Graphics Media Accelerator Driver

To install the chipset driver, please follow the steps below.

Step 1: Select the VGA driver from the list in Figure 7-2.

Step 2: Double-click the appropriate operating system folder.

Step 3: A new window appears (Figure 7-8).

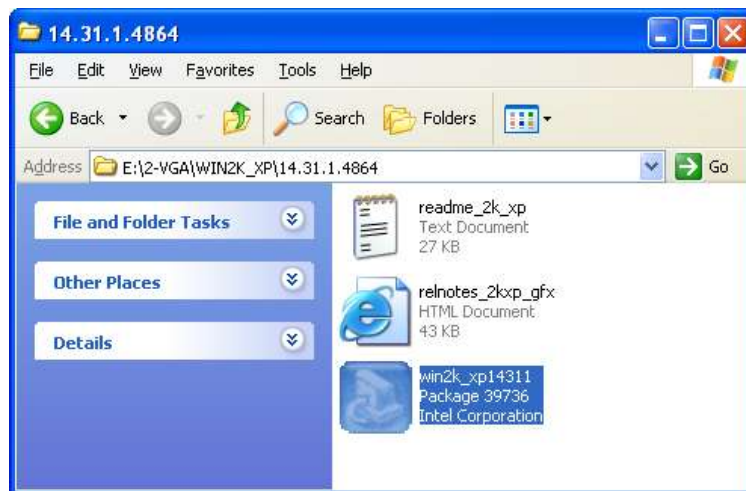

Figure 7-8: VGA Driver

Step 4: Double-click the installation program icon to continue the installation process.

IMBA-9454G Motherboard

Step 5: The information file shown in Figure 7-9 appears.

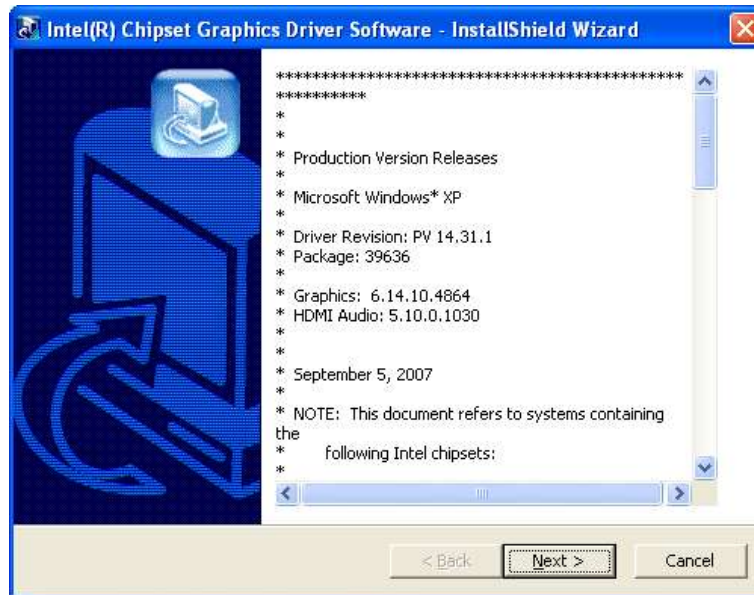

Figure 7-9: Intel® Graphics Media Accelerator InstallShield Wizard

Step 6: Click **NEXT** and the **Graphics Media Accelerator Driver Welcome** screen appears (Figure 7-10).



Figure 7-10: Intel® Graphics Media Accelerator Driver Welcome Screen

Step 7: Click **NEXT** and a license agreement appears (Figure 7-11).



Figure 7-11: Intel® Graphics Media Accelerator Driver License Agreement

Step 8: Read the license agreement. To accept the terms and conditions stipulated in the license agreement shown, click **YES** and the Readme File appears (Figure 7-12).

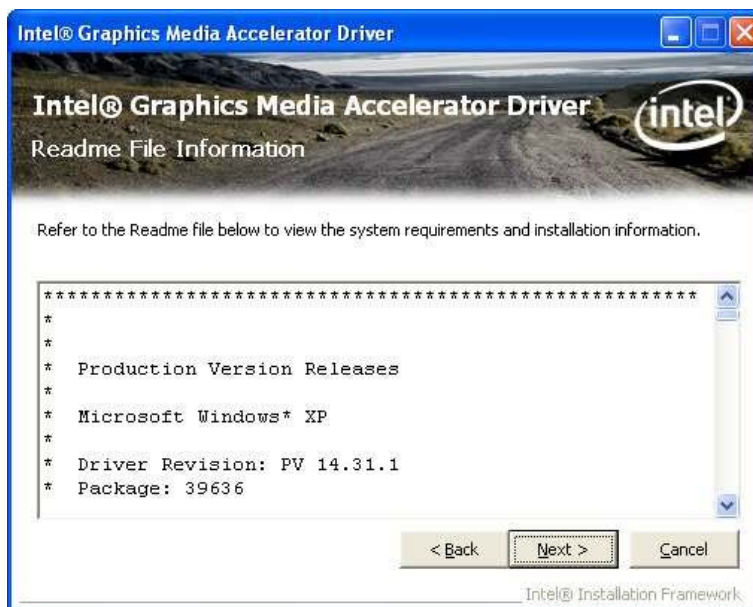

Figure 7-12: Intel® Graphics Media Accelerator Driver Readme

IMBA-9454G Motherboard

Step 9: Click **NEXT** to start the installation. After the driver installation process is complete, a confirmation screen appears (Figure 7-13).

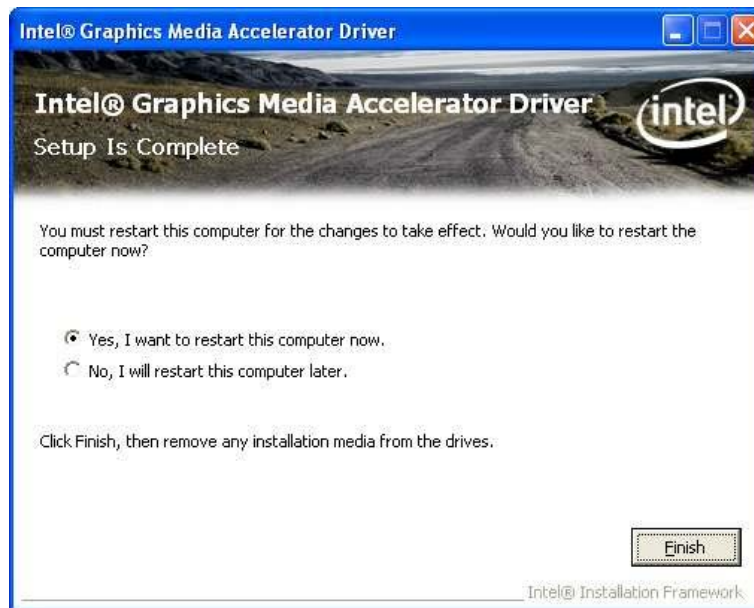

Figure 7-13: Intel® Graphics Media Accelerator Installation Complete

Step 10: The confirmation screen offers the option of restarting the computer now or later. For the settings to take effect, the computer must be restarted. Click **FINISH** to restart the computer.

7.5 Realtek LAN Driver (for GbE LAN) Installation

To install the Realtek LAN driver, please follow the steps below.

Step 1: Select the LAN driver from the list in Figure 7-2.

Step 2: Double-click the Realtek folder.

Step 3: A new window opens. (Figure 7-14)

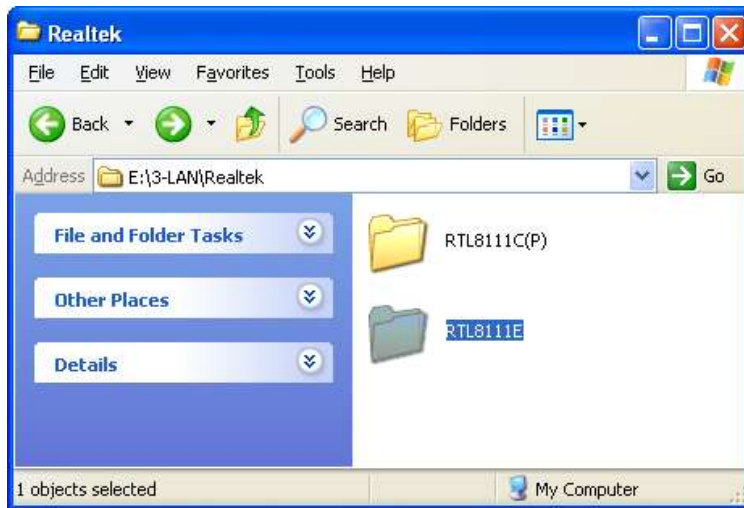

Figure 7-14: LAN Driver

Step 4: Double-click the RTL811E folder (Figure 7-14).

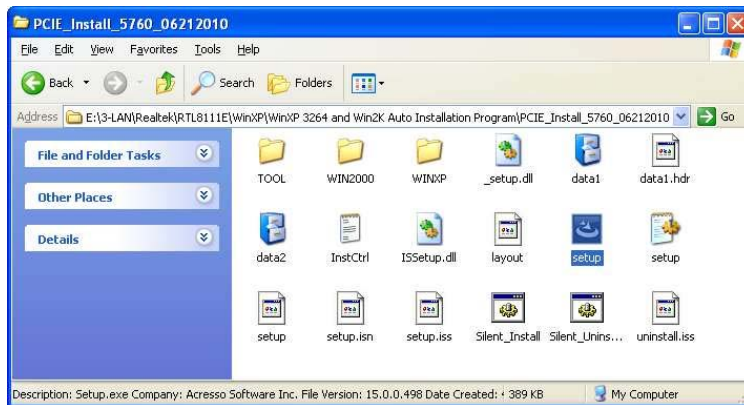

Figure 7-15: Locate the Setup Icon

Step 5: Double-click the **SETUP** icon to start the installation process (Figure 7-15).

Step 6: The Realtek InstallShield Wizard screen appears.

IMBA-9454G Motherboard

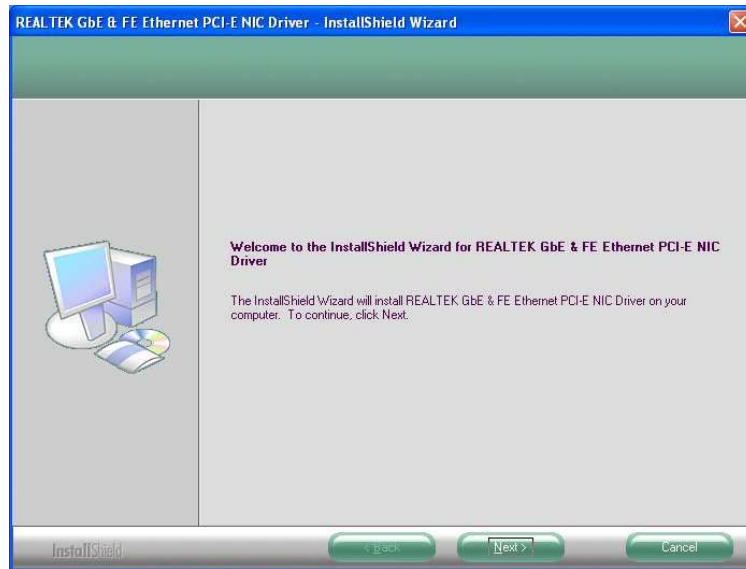

Figure 7-16: Realtek LAN Driver InstallShield Wizard

Step 7: Click **NEXT** to continue to the install screen (Figure 7-16).

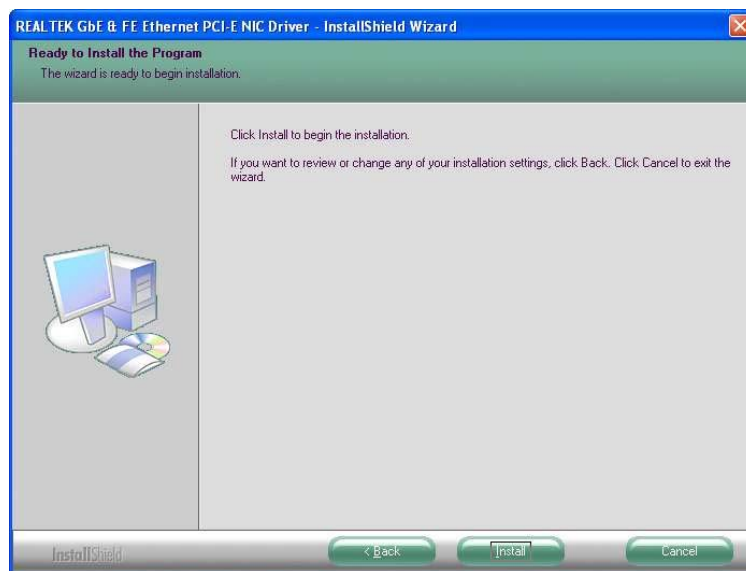

Figure 7-17: Realtek LAN Driver Install

Step 8: Click **INSTALL** to begin installing the driver (Figure 7-17). After the driver installation process is complete, a confirmation screen appears.

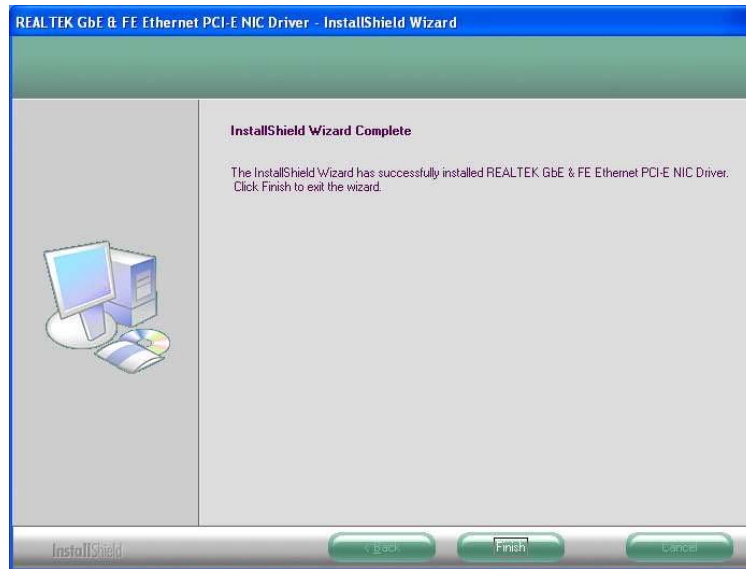

Figure 7-18: Realtek LAN Driver Complete

Step 9: Click **FINISH** to complete the driver installation.

7.6 Realtek AC`97 Audio Driver (ALC655) Installation

To install the Realtek AC `97 audio driver, please follow the steps below.

7.6.1 BIOS Setup

Step 1: Enter the BIOS setup. To do this, reboot the system and press **DEL** during POST.

Step 2: Go to the Southbridge Configuration menu. Set the **Audio Controller** option to [AC`97].

Step 3: Press **F10** to save the changes and exit the BIOS setup. The system reboots.

7.6.2 Driver Installation

To install the audio driver please follow the steps below.

Step 1: Select **AUDIO** from the list in **Figure 7-2**.

Step 2: A new window opens (Figure 7-19).

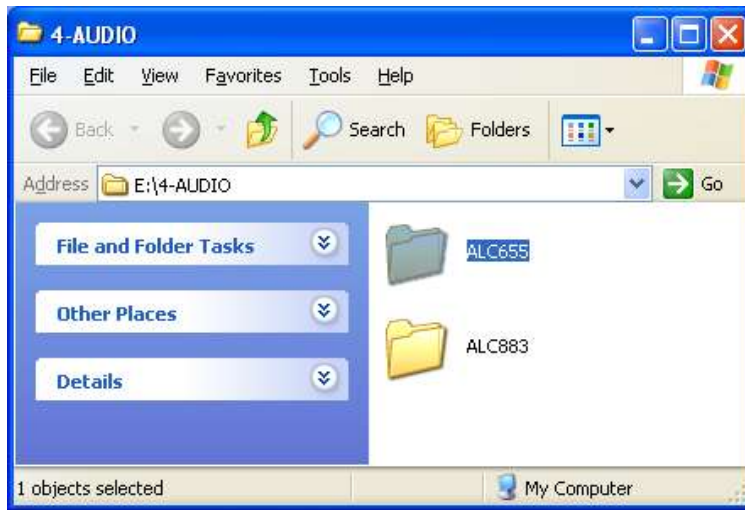

Figure 7-19: Select the Audio CODEC

Step 3: Double-click the ALC655 folder.

Step 4: Double-click the **WDM_A384** program icon in Figure 7-20.



Figure 7-20: Locate the Setup Program Icon

Step 5: Once initialized, the **InstallShield Wizard** welcome screen appears (Figure 7-21).

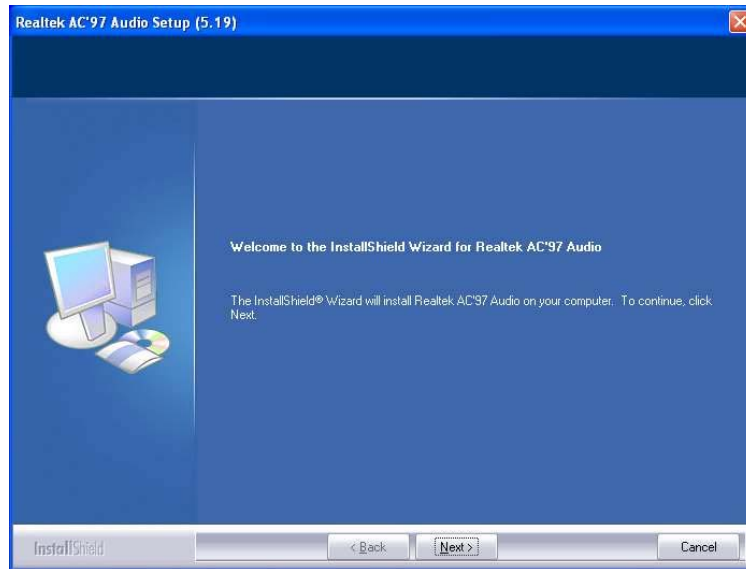

Figure 7-21: InstallShield Wizard Welcome Screen

Step 6: Click **NEXT** to continue the installation.

Step 7: At this stage the **Hardware Installation** screen shown in Figure 7-22 appears.



Figure 7-22: Audio Driver Digital Signal

Step 8: Click **YES** and the driver installation begins.

Step 9: After the driver installation process is complete, a confirmation screen appears (Figure 7-23).

IMBA-9454G Motherboard

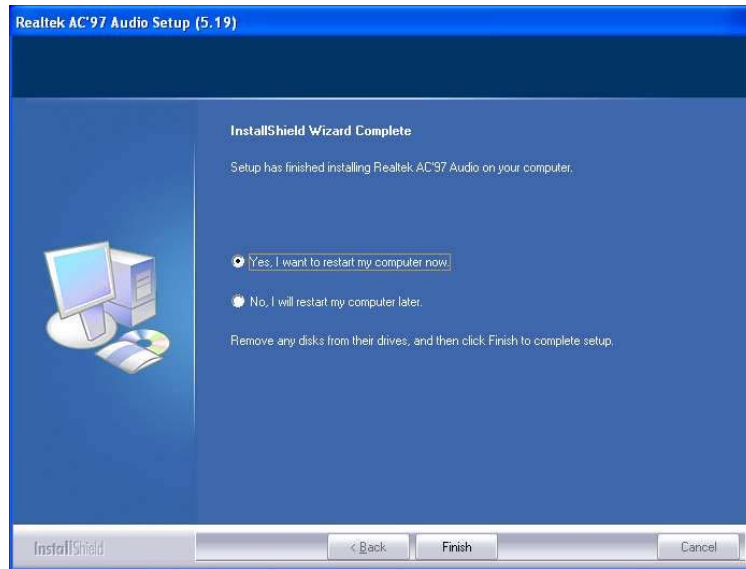

Figure 7-23: Restart the Computer

Step 10: The confirmation screen offers the option of restarting the computer now or later.

For the settings to take effect, the computer must be restarted. Click **FINISH** to restart the computer.

Appendix

A

BIOS Menu Options

A.1 BIOS Configuration Options

Below is a list of BIOS configuration options described in **Chapter 6**.

System Overview	103
System Time [xx:xx:xx]	104
System Date [xx/xx/xx]	104
ATA/IDE Configurations [Enhanced]	106
Configure SATA as [IDE].....	107
Configure SATA Channels [Before PATA]	107
IDE (Master) and IDE (Slave).....	107
Auto-Detected Drive Parameters.....	108
Type [Auto]	109
ZIP.....	109
LS-120	109
LBA/Large Mode [Auto].....	109
Block (Multi Sector Transfer) [Auto]	110
PIO Mode [Auto].....	110
DMA Mode [Auto].....	110
S.M.A.R.T [Auto].....	111
32Bit Data Transfer [Enabled].....	111
Floppy A.....	112
Serial Port1 Address [3F8/IRQ4]	113
Serial Port1 Mode [Normal].....	113
Serial Port2 Address [2F8/IRQ3]	114
Serial Port2 Mode [Normal].....	114
Parallel Port Address [378]	114
Parallel Port Mode [Normal].....	114
Parallel Port IRQ [IRQ7].....	115
Serial Port3 Address [3E8].....	115
Serial Port4 Address [2E8].....	116
Serial Port5 Address [2F0].....	116
Serial Port6 Address [2E0].....	116
CPU FAN Mode Setting [Full On mode].....	117
System FAN1 Mode Setting [Full On Mode].....	118

IMBA-9454G Motherboard

System FAN2 Mode Setting [Full On Mode].....	118
Suspend Mode [S1 (POS)].....	120
Power Button Mode [On/Off].....	121
Restore on AC Power Loss [Last State].....	121
Resume on KeyBoard/Mouse [Disabled].....	122
Resume on Ring [Disabled]	122
Resume on PME# [Disabled]	122
Resume on PCI-Express WAKE# [Enabled].....	123
Resume On RTC Alarm [Disabled].....	123
RTC Alarm Date (Days).....	123
System Time	123
Remote Access [Disabled].....	124
Serial port number [COM1]	124
Base Address, IRQ [3F8h, 4].....	125
Serial Port Mode [115200 8,n,1].....	125
Redirection After BIOS POST [Always]	125
Terminal Type [ANSI].....	126
TCG/TPM Support [No].....	126
USB Configuration.....	127
USB Function [Enabled].....	127
USB 2.0 Controller [Enabled].....	128
Legacy USB Support [Enabled].....	128
USB2.0 Controller Mode [HiSpeed].....	128
IRQ#.....	129
DMA Channel#.....	130
Reserved Memory Size [Disabled]	130
Quick Boot [Enabled]	132
Quiet Boot [Disabled]	132
AddOn ROM Display Mode [Force BIOS]	133
Bootup Num-Lock [On]	133
Boot From LAN Support [Disabled].....	133
Change Supervisor Password.....	136
Change User Password.....	136
Memory Hole [Disabled].....	138
Initiate Graphic Adapter	138

Internal Graphics Mode Select [Enable, 8MB]	138
DVMT Mode Select [DVMT Mode].....	138
DVMT/FIXED Memory [128 MB]	139
Spread Spectrum Mode [Disabled]	140
Audio Controller [AC'97 Audio].....	140
Save Changes and Exit	141
Discard Changes and Exit.....	141
Discard Changes.....	141
Load Optimal Defaults.....	141
Load Failsafe Defaults.....	142

Appendix

B

Watchdog Timer

**NOTE:**

The following discussion applies to DOS environment. IEI support is contacted or the IEI website visited for specific drivers for more sophisticated operating systems, e.g., Windows and Linux.

The Watchdog Timer is provided to ensure that standalone systems can always recover from catastrophic conditions that cause the CPU to crash. This condition may have occurred by external EMIs or a software bug. When the CPU stops working correctly, Watchdog Timer either performs a hardware reset (cold boot) or a Non-Maskable Interrupt (NMI) to bring the system back to a known state.

A BIOS function call (INT 15H) is used to control the Watchdog Timer.

INT 15H:**AH – 6FH Sub-function:**

AL – 2:	Sets the Watchdog Timer's period.
---------	-----------------------------------

IMBA-9454G Motherboard

BL:	Time-out value (Its unit-second is dependent on the item "Watchdog Timer unit select" in CMOS setup).
-----	---

Table B-1: AH-6FH Sub-function

Call sub-function 2 to set the time-out period of Watchdog Timer first. If the time-out value is not zero, the Watchdog Timer starts counting down. When the timer value reaches zero, the system resets. To ensure that this reset condition does not occur, calling sub-function 2 must periodically refresh the Watchdog Timer. However, the watchdog timer is disabled if the time-out value is set to zero.

A tolerance of at least 10% must be maintained to avoid unknown routines within the operating system (DOS), such as disk I/O that can be very time-consuming.



NOTE:

When exiting a program it is necessary to disable the Watchdog Timer, otherwise the system resets.

Example program:

```

; INITIAL TIMER PERIOD COUNTER
;
W_LOOP:

        MOV     AX, 6F02H      ;setting the time-out value
        MOV     BL, 30        ;time-out value is 48 seconds
        INT     15H

;
; ADD THE APPLICATION PROGRAM HERE
;

        CMP     EXIT_AP, 1    ;is the application over?
        JNE     W_LOOP       ;No, restart the application
    
```



```
MOV    AX, 6F02H    ;disable Watchdog Timer
MOV    BL, 0        ;
INT    15H
;
; EXIT ;
```

Appendix

C

Address Mapping

C.1 IO Address Map



Table C-1: IO Address Map

C.2 1st MB Memory Address Map

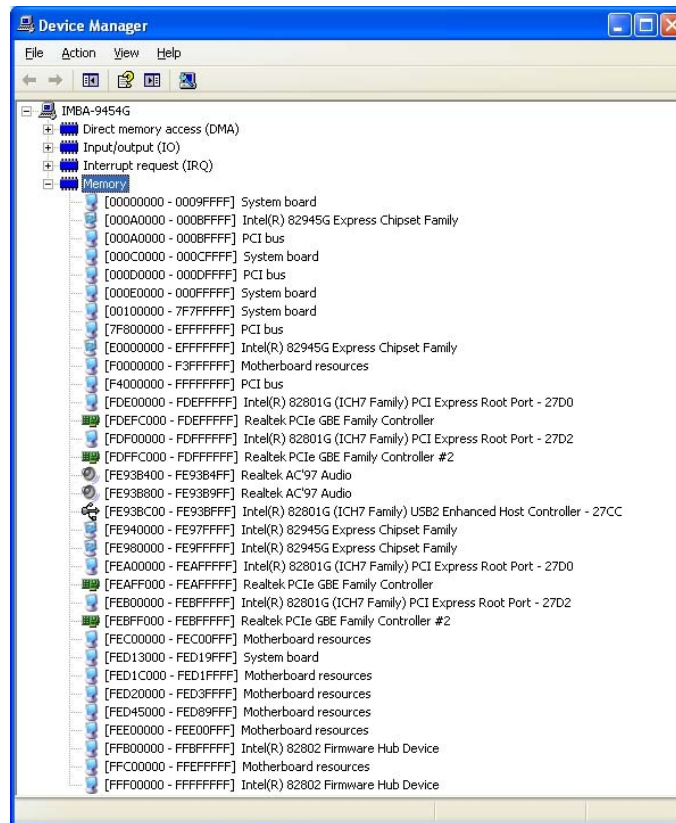

Table C-2: 1st MB Memory Address Map

IMBA-9454G Motherboard

C.3 IRQ Mapping Table

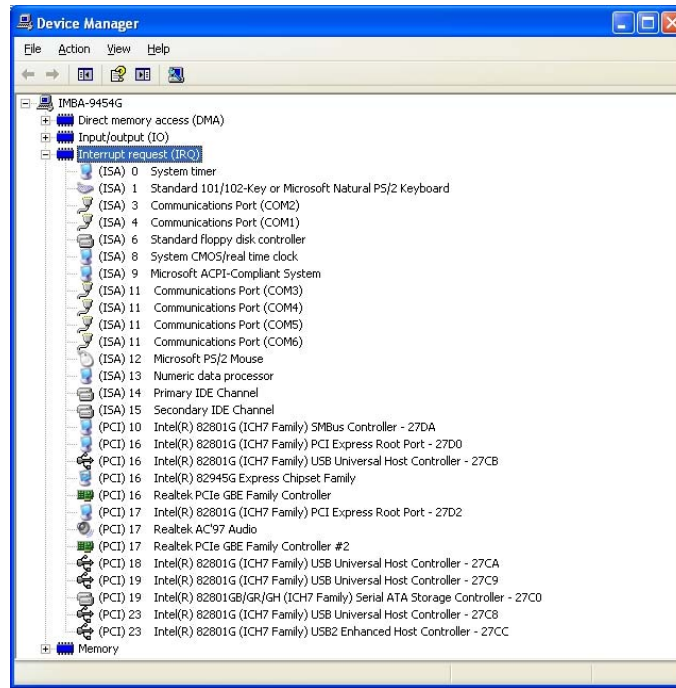

Table C-3: IRQ Mapping Table

C.4 DMA Channel Assignments

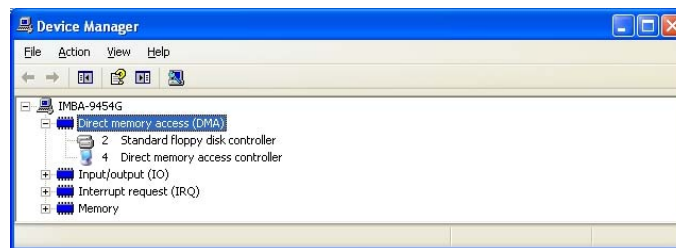

Table C-4: IRQ Mapping Table



Appendix

D

External AC'97 Audio CODEC

D.1 Introduction

The motherboard comes with an onboard Realtek ALC655 CODEC. The ALC655 is a 16-bit, full-duplex AC'97 Rev. 2.3 compatible six-channel audio CODEC that provides three pairs of stereo outputs with 5-bit volume control, a mono output, and multiple stereo and mono inputs, along with flexible mixing, gain, and mute functions.

D.1.1 Accessing the AC'97 CODEC

The CODEC is accessed through the phone jacks on the rear panel of the motherboard.

The phone jacks include:

- LINE IN
- LINE OUT
- MIC IN

D.1.2 Driver Installation

The driver installation has been described in **Section 7.6**.

After rebooting, the sound effect configuration utility appears in the **Windows Control Panel (Figure D-1)**. If the peripheral speakers are properly connected, sound effects should be heard.

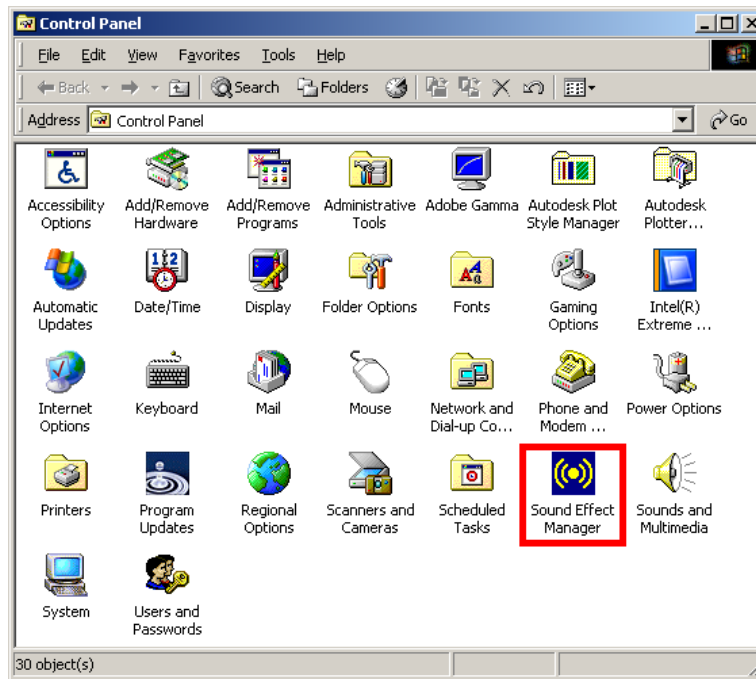

Figure D-1: Control Panel Sound Effect Manager

D.2 Sound Effect Configuration

D.2.1 Accessing the Sound Effects Manager

Follow the steps below to access the **Sound Effect Manager**.

Step 1: Install the ALC655 audio CODEC driver (see **Section 7.6**).

Step 2: Click the **Sound Effect Manager** icon in the system task bar (**Figure D-2**).



Figure D-2: Sound Effect Manager Icon [Task Bar]

Step 3: The sound effect manager appears (Figure D-3).

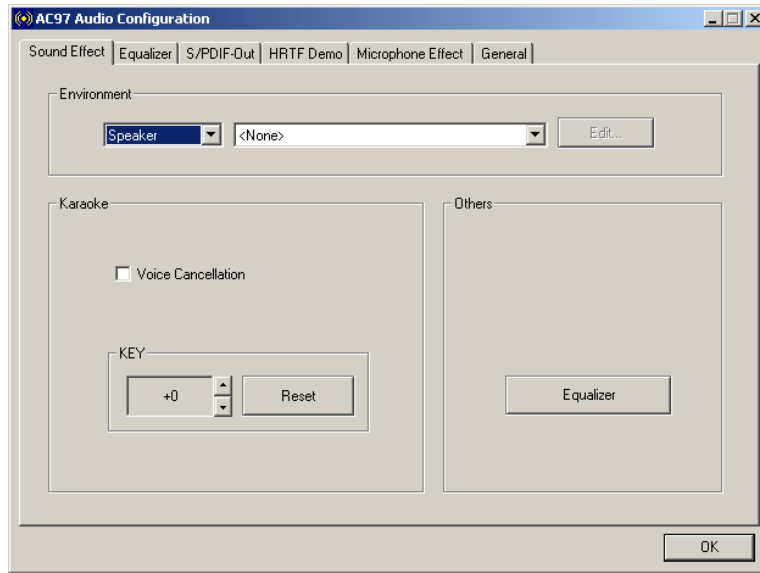

Figure D-3: Sound Effects Manager (ALC655)



NOTE:

The Sound Effect Manager shown in Figure D-3 is for the RealTek ALC655 audio CODEC. Different CODECs may have different sound manager appearances.

The following section describes the different configuration options in the Sound Effect Manager.

D.2.2 Sound Effect Manager Configuration Options

The **Sound Effects Manager** enables configuration of the items listed below. To configure these items click the corresponding menu tab in the **Sound Effects Manager** (Figure D-3).

IMBA-9454G Motherboard



NOTE:

The Karaoke Mode is configured in the Sound Effect menu. To access Karaoke configuration settings, click on the Sound Effect menu tab.

- Sound Effect
- Karaoke Mode
- Equalizer
- Speaker Configuration
- Speaker Test
- S/PDIF-In
- S/PDIF-Out
- Connector Sensing
- HRTF Demo
- Microphone Effect
- General



NOTE:

Not all RealTek Sound Effect Managers have all the above listed options. The Sound Effect Manager loaded onto the system may only have some of the options listed above.

Below is a brief description of the available configuration options in the **Sound Effects Manager**.

- **Sound Effect** - Select a sound effect from the 23 listed options in the drop down menu. Selected sound effect properties can be edited. Click **EDIT** to edit the sound effect.
- **Karaoke Mode** - **Karaoke Mode** is accessed in the Sound Effect tab. The **Voice Cancellation** disables the vocal part of the music being played. The

Key adjustment up or down arrow icons enable users to define a key that fits a certain vocal range.

- **Equalizer Selection** - Preset equalizer settings enable easy audio range settings. Ten frequency bands can be configured.
- **Speaker Configuration** - Multi-channel speaker settings are configured in this menu. Configurable options include:
 - Headphone
 - Channel mode for stereo speaker output
 - Channel mode for 4 speaker output
 - Channel mode for 5.1 speaker output
 - Synchronize the phonejack switch with speakers settings
- **Speaker Test** - Each speaker connected to the system is tested individually to see if the 4-channel or 6-channel audio operates properly.
- **S/PDIF-In & S/PDIF-Out** - S/PDIF is used to transmit digital and analog audio signals with either a 48 or 44.1kHz sample rate.
- **HRTF Demo** - Adjust HRTF (Head Related Transfer Functions) 3D positional audio before running 3D applications.
- **Microphone Effect** - Microphone noise suppression is enabled in this menu.
- **General** - General information about the installed AC'97 audio configuration utility is listed here.

Index

+

+12V ATX power supply connector.....	36
location and pinouts	36

A

AC'97 Audio CODEC	174
ACPI	119
Address Mapping.....	169
airflow	87
ALC655.....	176
anti-static precautions.....	27, 73
anti-static pad	27, 73
anti-static wristband.....	27, 73
handling.....	27, 73
self-grounding.....	27, 73
ASKIR interface	47
ATA flat cable	88
ATX power supply connector	36
location and pinouts	36
Audio	
connection	95
audio connector	38
location and pinouts	38
Audio connector.....	95
auxiliary audio connector.....	38
location and pinouts	38

B

BIOS	99
ACPI Configuration.....	119
APM Configuration	120

ASF Configuration	123
Boot	131
Boot Device Priority	134
Boot Settings Configuration.....	132
Chipset.....	136
CPU Configuration.....	105
Exit.....	141
Floppy Configuration	111
General ACPI Configuration	119
Hardware Health Configuration	117
IDE Configuration	106
IDE Master, IDE Slave.....	108
NorthBridge Configuration.....	137
Removable Drives	134
Security.....	135
Super IO Configuration.....	112
System Overview.....	103
Trusted Computing	126
USB Configuration.....	127
BIOS Chipset	20
BIOS Menu Options.....	160

C

cables.....	87
CD in connector	39
location and pinouts.....	39
CF card	40
location and pinouts.....	40
setup jumper	84
socket	40
CF card setup jumper	84
chassis	87
installation.....	87

IMBA-9454G Motherboard

chipset.....	17	TPM	61
northbridge	15	USB (internal)	62
southbridge.....	17	cooling.....	87
clear CMOS jumper	84	airflow	87
CMOS	84	cooling fan.....	80
clear CMOS jumper.....	84	cooling kit installation	80
COM 2		CPU	
COM 2 mode selection.....	85	cooling fan	80
COM 2 mode selection jumper	85	heat sink	80
CompactFlash.....	40	installation.....	76
socket location and pinouts	40	CPU	14, 15
connectors, pinouts and location		compatible	14, 15
(RS-422/485) serial port.....	59		
+12V ATX power supply	35		
ATX power supply	36		
audio.....	37		
auxiliary audio	38		
CD in.....	39		
COM 2 serial port	58		
CompactFlash	40		
digital input/output	41		
fans.....	42		
floppy disk	43		
front panel audio.....	45		
IDE.....	45		
infrared interface	47		
multi-panel	48		
PCI Express power.....	52		
PCI Express x16 slot.....	49		
PCI slot.....	53		
serial port (COM 2).....	58		
serial port (RS-422/485).....	59		
serial ports	57		
serial SATA drives.....	56		
SPDIF	60		

D

Data Flow Block Diagram	13
DB-15.....	68
DB-15 connector.....	93, 96
DB-25.....	64
DB-9.....	69
DB-9 connector	97
digital input/output connector.....	42
location and pinouts.....	42
dimensions.....	11
board	11
external peripheral interface connector panel.....	12
DIMM	82
installation.....	82
specifications	82
Drivers	
Audio Driver	156
Chipset Driver.....	147
Intel Graphics Media Accelerator Driver	150

LAN Driver153

E

electrostatic discharge27, 73

Enhanced Hardware Monitor22

Environmental and Power Specifications ..23

Ethernet

 connection93

external indicators.....48

external peripheral interface91

 connection91

 connectors91

External Peripheral Interface Connectors..63

 Audio Jacks67

 Ethernet (RJ-45).....65

 Keyboard/Mouse63

 Parallel Port.....64

 Serial Communications (COM)69

 USB67

 VGA68

external switches48

F

fan connector42

 location and pinouts42

fan speed controller22

Features.....3

floppy disk connector43

 location and pinouts43

floppy disk drive43

front panel connector45

 location and pinouts45

FSB106

G

graphics and memory controller hub15

Graphics Media Accelerator.....16

H

hard disk drives

 SATA.....57

HDD LED48

heat sink.....80

HT technology76

 system requirements76

hyper-threading technology76

 system requirements76

I

IDE connector, 40-pin46

 location and pinouts.....46

IDE device.....88

 ATA flat cable88

 connector88

IDE interface18

infrared interface47

 Amplitude Shift Key Infrared.....47

 ASKIR.....47

 Serial Infrared47

 SIR.....47

infrared interface connector47

 location and pinouts.....47

installation checklist74

IrDA113

IMBA-9454G Motherboard

J

jumper	83
CF card setup	84
clear CMOS	84
COM 2 mode selection	85
jumper configuration	83
jumper settings	83

K

keyboard controller	22
---------------------------	----

L

LED	
HDD	48
power	48
LPC interface	21

M

memory module installation	82
memory support	16
multi-panel connector	48
location and pinouts	48

N

northbridge chipset	15
---------------------------	----

O

Operating Temperature	24
-----------------------------	----

P

parallel port	22
---------------------	----

PC speaker	48
PCI bus	20
PCI Express GbE controller	20
PCI Express x16 Slot	49
location and pinouts	49
PCI interface	19
PCI slot	53
location and pinouts	53
peripheral device cables	87
PICMG 1.0 form factor	3
power button	48
Power Button Mode	121
Power Consumption	24
power LED	48
power supply	36
ATX power supply	36
processors	14, 15
PS/2	63
PS/2 connector	92
PS/2 keyboard	
connection	92

R

real time clock	19
reset button	48
RJ-45 connector	94
RS-232	58
cable connection	89
COM 2 location and pinouts	58
connector location and pinouts	58
dual cable	89
serial port devices	58
RS-232 serial port devices	58
RS-232/422/485	58

COM 2 location and pinouts58
 serial port devices58
 RS-232/422/485 serial port devices58
 RS-422/48559
 COM 2 location and pinouts59
 connector location and pinouts59
 serial port devices59
 RS-422/485 serial port devices59

S

SATA
 controller19
 SATA drive90
 cables90
 connection90
 power cable90
 SATA drive connector57
 location and pinouts57
 SATA drives57
 Serial
 connection97
 serial port connector58, 59
 location and pinouts58, 59
 SIR interface47
 socket LGA775 CPU
 cooling kit80
 cooling kit installation80
 installation76
 Sound Effect Configuration177
 Sound Effects Manager177
 southbridge chipset17
 Super I/O chipset21
 System Monitoring23
 system voltages 117, 118

T

technical specifications6
 Temperature Control24

U

unpacking28
 unpacking checklist28
 unpacking precautions28
 USB
 connection94
 USB62
 controller20
 devices62
 port62
 USB 1.162
 USB 2.062
 USB 1.162
 USB 2.062
 USB connector94
 USB connector, internal62
 location and pinouts62

V

VGA monitor
 connection 93, 96

W

warranty validation74
 Watchdog Timer 165

