

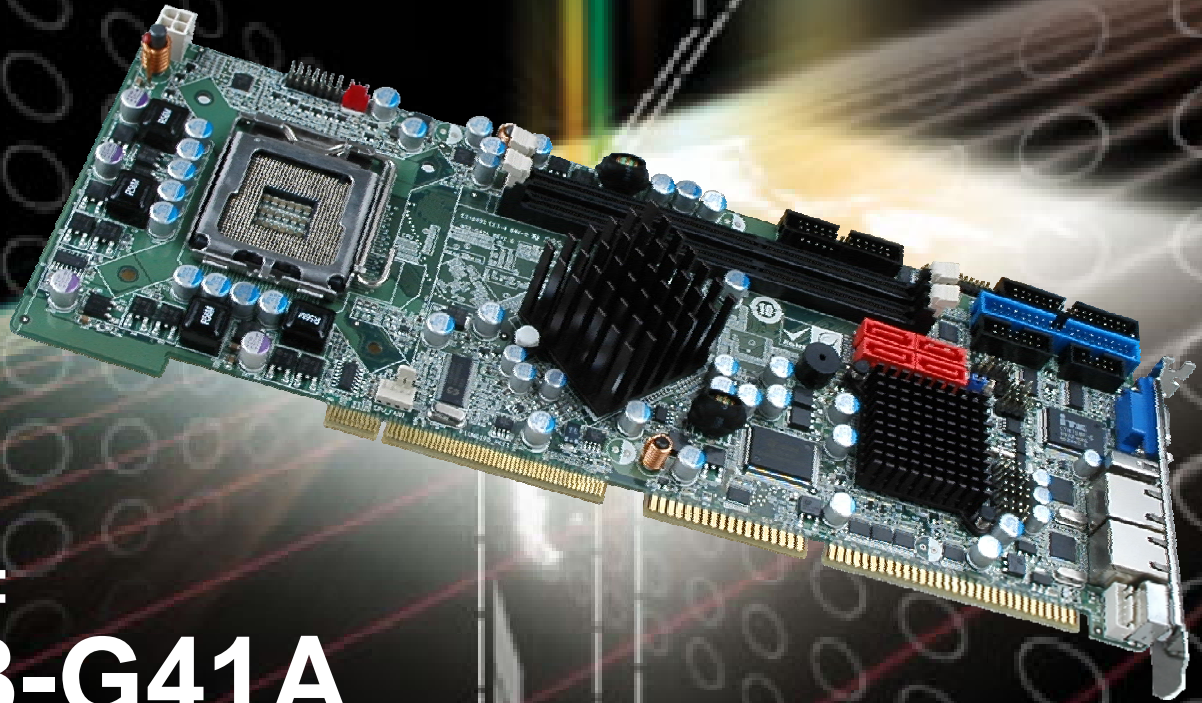

IEI Technology Corp.



**MODEL:
WSB-G41A**

**PCIMG 1.0 LGA775 Motherboard for Intel® Core™2
Duo/Quad/Extreme CPU, 800/1066/1333 MHz FSB, VGA, LAN,
SATA, PCI, USB, HD Audio, RoHS Compliant**

User Manual

Rev. 1.01 – 3 November, 2010



Revision

Date	Version	Changes
3 November, 2010	1.01	Modified Table 3-3: ATX Power Supply Enable Connector Pinouts
10 May, 2010	1.00	Initial release

Copyright

COPYRIGHT NOTICE

The information in this document is subject to change without prior notice in order to improve reliability, design and function and does not represent a commitment on the part of the manufacturer.

In no event will the manufacturer be liable for direct, indirect, special, incidental, or consequential damages arising out of the use or inability to use the product or documentation, even if advised of the possibility of such damages.

This document contains proprietary information protected by copyright. All rights are reserved. No part of this manual may be reproduced by any mechanical, electronic, or other means in any form without prior written permission of the manufacturer.

TRADEMARKS

All registered trademarks and product names mentioned herein are used for identification purposes only and may be trademarks and/or registered trademarks of their respective owners.

Table of Contents

1 INTRODUCTION.....	1
1.1 INTRODUCTION.....	2
1.2 BENEFITS	2
1.3 FEATURES.....	2
1.4 CONNECTORS	3
1.5 DIMENSIONS.....	4
1.6 DATA FLOW	5
1.7 TECHNICAL SPECIFICATIONS	6
2 PACKING LIST.....	8
2.1 ANTI-STATIC PRECAUTIONS	9
2.2 UNPACKING PRECAUTIONS.....	9
2.3 PACKING LIST.....	10
2.4 OPTIONAL ITEMS	11
3 CONNECTORS	13
3.1 PERIPHERAL INTERFACE CONNECTORS.....	14
3.1.1 <i>Layout</i>	14
3.1.2 <i>Peripheral Interface Connectors</i>	14
3.1.3 <i>External Interface Panel Connectors</i>	15
3.2 INTERNAL PERIPHERAL CONNECTORS	15
3.2.1 <i>ATX Power Control Connector</i>	15
3.2.2 <i>Audio Kit Connector</i>	16
3.2.3 <i>Battery Connector</i>	17
3.2.4 <i>CPU Fan Connector</i>	18
3.2.5 <i>CPU Power Input Connector</i>	18
3.2.6 <i>DVI Connector</i>	19
3.2.7 <i>Digital I/O Connector</i>	20
3.2.8 <i>Floppy Disk Connector</i>	21
3.2.9 <i>Front Panel Connector</i>	22
3.2.10 <i>Infrared Interface Connector</i>	23

WSB-G41A CPU Card

3.2.11 Keyboard Connector	24
3.2.12 Memory Slot	25
3.2.13 IDE Connector	26
3.2.14 Parallel Port Connector	27
3.2.15 SATA Drive Connectors	28
3.2.16 Serial Port Connector	29
3.2.17 SPI Flash Connector	30
3.2.18 USB Connectors	31
3.3 EXTERNAL PERIPHERAL INTERFACE CONNECTOR PANEL	31
3.3.1 Keyboard/Mouse Connector	32
3.3.2 LAN Connector	33
3.3.3 USB Connector	33
3.3.4 VGA Connector	34
4 INSTALLATION	35
4.1 ANTI-STATIC PRECAUTIONS	36
4.2 INSTALLATION CONSIDERATIONS	36
4.3 BASIC INSTALLATION	37
4.3.1 CPU Installation	38
4.3.2 Cooling Kit Installation	41
4.3.3 DIMM Installation	42
4.3.4 Backplane Installation	43
4.3.5 CPU Card Installation	44
4.4 JUMPER SETTINGS	44
4.4.1 Clear CMOS Jumper	45
4.5 INTERNAL PERIPHERAL DEVICE CONNECTIONS	45
4.5.1 SATA Drive Connection	45
4.5.2 USB Cable (Dual Port) with Slot Bracket	47
4.6 EXTERNAL PERIPHERAL INTERFACE CONNECTION	48
4.6.1 LAN Connection	48
4.6.2 USB Device Connection	49
4.6.3 VGA Monitor Connection	50
4.7 SOFTWARE INSTALLATION	51
5 BIOS	53

5.1 INTRODUCTION.....	54
5.1.1 Starting Setup.....	54
5.1.2 Using Setup.....	54
5.1.3 Getting Help.....	55
5.1.4 Unable to Reboot after Configuration Changes.....	55
5.1.5 BIOS Menu Bar.....	55
5.2 MAIN.....	56
5.3 ADVANCED.....	57
5.3.1 CPU Configuration.....	58
5.3.2 IDE Configuration.....	59
5.3.2.1 IDE Master, IDE Slave.....	61
5.3.3 Floppy Configuration.....	65
5.3.4 Super IO Configuration.....	66
5.3.5 Hardware Health Configuration.....	70
5.3.6 Power Configuration.....	73
5.3.6.1 ACPI Settings.....	73
5.3.6.2 APM Configuration.....	74
5.3.7 Remote Access Configuration.....	76
5.3.8 USB Configuration.....	78
5.4 PCI/PNP.....	80
5.5 BOOT.....	83
5.5.1 Boot Settings Configuration.....	83
5.5.2 Boot Device Priority.....	85
5.5.3 Hard Disk Drives.....	86
5.5.4 Removable Drives.....	86
5.5.5 CD/DVD Drives.....	87
5.6 SECURITY.....	87
5.7 CHIPSET.....	88
5.7.1 Northbridge Configuration.....	89
5.7.1.1 Video Function Configuration.....	91
5.7.2 Southbridge Configuration.....	91
5.8 EXIT.....	92
A BIOS OPTIONS.....	95
B TERMINOLOGY.....	99

C ONE KEY RECOVERY.....	103
C.1 ONE KEY RECOVERY INTRODUCTION	104
<i>C.1.1 System Requirement</i>	<i>104</i>
<i>C.1.2 Supported Operating System.....</i>	<i>104</i>
C.2 SETUP PROCEDURE FOR WINDOWS	106
<i>C.2.1 Hardware and BIOS Setup</i>	<i>107</i>
<i>C.2.2 Create Partitions</i>	<i>107</i>
<i>C.2.3 Install Operating System, Drivers and Applications.....</i>	<i>110</i>
<i>C.2.4 Build-up Recovery Partition.....</i>	<i>110</i>
<i>C.2.5 Create Factory Default Image</i>	<i>112</i>
C.3 SETUP PROCEDURE FOR LINUX	117
C.4 RECOVERY TOOL FUNCTIONS	120
<i>C.4.1 Factory Restore</i>	<i>122</i>
<i>C.4.2 Backup System.....</i>	<i>123</i>
<i>C.4.3 Restore Your Last Backup.....</i>	<i>124</i>
<i>C.4.4 Manual</i>	<i>125</i>
D WATCHDOG TIMER	126
E DIGITAL I/O INTERFACE	129
E.1 INTRODUCTION	130
E.2 DIO CONNECTOR PINOUTS	130
E.3 ASSEMBLY LANGUAGE EXAMPLE	130
F HAZARDOUS MATERIALS DISCLOSURE.....	131
F.1 HAZARDOUS MATERIALS DISCLOSURE TABLE FOR IPB PRODUCTS CERTIFIED AS ROHS COMPLIANT UNDER 2002/95/EC WITHOUT MERCURY	132

List of Figures

Figure 1-1: WSB-G41A	2
Figure 1-2: Connectors	3
Figure 1-3: Dimensions (mm).....	4
Figure 1-4: Data Flow Diagram.....	5
Figure 3-1: Connectors and Jumpers.....	14
Figure 3-2: ATX Power Supply Enable Connector Location	16
Figure 3-3: Audio Kit Connector Location	17
Figure 3-4: Battery Connector Location.....	17
Figure 3-5: CPU Fan Connector Location	18
Figure 3-6: CPU Power Input Connector Location.....	19
Figure 3-7: DVI Connector Location	20
Figure 3-8: Digital I/O Connector Locations	21
Figure 3-9: Floppy Drive Connector Location	22
Figure 3-10: Front Panel Connector Location	23
Figure 3-11: Infrared Connector Location.....	24
Figure 3-12: Keyboard Connector Location	25
Figure 3-13: Memory Card Slot Location	26
Figure 3-14: IDE Connector Location	26
Figure 3-15: Parallel Port Connector Location	28
Figure 3-16: SATA Drive Connector Location	29
Figure 3-17: Serial Port Connector Location	29
Figure 3-18: SPI Flash Connector	30
Figure 3-19: USB Connector Pinout Locations	31
Figure 3-20: External Peripheral Interface Connector	32
Figure 3-21: PS/2 Pinout and Configuration	32
Figure 3-22: VGA Connector	34
Figure 4-1: Intel LGA775 Socket	38
Figure 4-2: Remove Protective Cover.....	39
Figure 4-3: CPU Socket Load Plate.....	39
Figure 4-4: Insert the Socket LGA775 CPU.....	40

WSB-G41A CPU Card

Figure 4-5: Cooling Kits	41
Figure 4-6: Securing the Heat sink to the WSB-G41A	42
Figure 4-7: DIMM Installation.....	43
Figure 4-8: Clear BIOS Jumper Location	45
Figure 4-9: SATA Drive Cable Connection.....	46
Figure 4-10: SATA Power Drive Connection.....	47
Figure 4-11: Dual USB Cable Connection	48
Figure 4-12: LAN Connection	49
Figure 4-13: USB Device Connection	50
Figure 4-14: VGA Connector	51
Figure 4-15: Introduction Screen	52
Figure 4-16: Available Drivers	52
Figure C-1: Recovery Tool Setup Menu	108
Figure C-2: Command Mode.....	108
Figure C-3: Partition Creation Commands.....	109
Figure C-4: System Configuration for Windows	111
Figure C-5: Build-up Recovery Partition	111
Figure C-6: Press any key to continue	112
Figure C-7: Press F3 to Boot into Recovery Mode.....	112
Figure C-8: Recovery Tool Menu	113
Figure C-9: About Symantec Ghost Window.....	113
Figure C-10: Symantec Ghost Path	114
Figure C-11: Select a Local Source Drive	114
Figure C-12: Select a Source Partition from Basic Drive	114
Figure C-13: File Name to Copy Image to	115
Figure C-14: Compress Image.....	116
Figure C-15: Image Creation Confirmation	116
Figure C-16: Image Creation Complete	116
Figure C-17: Image Creation Complete	117
Figure C-18: Press Any Key to Continue	117
Figure C-19: Partitions for Linux.....	118
Figure C-20: System Configuration for Linux.....	119
Figure C-21: Access menu.lst in Linux (Text Mode).....	119
Figure C-22: Recovery Tool Menu	120
Figure C-23: Recovery Tool Main Menu	121



Figure C-24: Restore Factory Default..... 122

Figure C-25: Recovery Complete Window 122

Figure C-26: Backup System..... 123

Figure C-27: System Backup Complete Window 123

Figure C-28: Restore Backup 124

Figure C-29: Restore System Backup Complete Window 124

Figure C-30: Symantec Ghost Window 125

List of Tables

Table 1-1: Technical Specifications.....	7
Table 2-1: Packing List.....	11
Table 2-2: Optional Items.....	12
Table 3-1: Internal Peripheral Connectors.....	15
Table 3-2: External Peripheral Connectors.....	15
Table 3-3: ATX Power Supply Enable Connector Pinouts.....	16
Table 3-4: Audio Kit Connector Pinouts.....	17
Table 3-5: Battery Connector Pinouts.....	18
Table 3-6: CPU Fan Connector Pinouts.....	18
Table 3-7: CPU Power Input Connector Pinouts.....	19
Table 3-8: DVI Connector Pinouts.....	20
Table 3-9: Digital I/O Connector Pinouts.....	21
Table 3-10: Floppy Drive Connector Pinouts.....	22
Table 3-11: Front Panel Connector Pinouts.....	23
Table 3-12: Infrared Connector Pinouts.....	24
Table 3-13: Keyboard Connector Pinouts.....	25
Table 3-14: IDE Connector Pinouts.....	27
Table 3-15: Parallel Port Connector Pinouts.....	28
Table 3-16: Serial Port Connector Pinouts.....	30
Table 3-17: SPI Flash Connector.....	30
Table 3-18: USB Port Connector Pinouts.....	31
Table 3-19: Keyboard Connector Pinouts.....	33
Table 3-20: LAN Pinouts.....	33
Table 3-21: USB Port Pinouts.....	34
Table 3-22: VGA Connector Pinouts.....	34
Table 4-1: Jumpers.....	44
Table 4-2: Clear BIOS Jumper Settings.....	45
Table 5-1: BIOS Navigation Keys.....	55

BIOS Menus

BIOS Menu 1: Main	56
BIOS Menu 2: Advanced	58
BIOS Menu 3: CPU Configuration	58
BIOS Menu 4: IDE Configuration	59
BIOS Menu 5: IDE Master and IDE Slave Configuration	61
BIOS Menu 6: IDE Master and IDE Slave Configuration	66
BIOS Menu 7: Super IO Configuration	67
BIOS Menu 8: Hardware Health Configuration	70
BIOS Menu 9: ACPI Configuration	73
BIOS Menu 10: ACPI Settings	73
BIOS Menu 11: APM Configuration	74
BIOS Menu 12: Remote Access Configuration	76
BIOS Menu 13: USB Configuration	79
BIOS Menu 14: PCI/PnP Configuration	81
BIOS Menu 15: Boot	83
BIOS Menu 16: Boot Settings Configuration	83
BIOS Menu 17: Boot Device Priority Settings	85
BIOS Menu 18: Hard Disk Drives	86
BIOS Menu 19: Removable Drives	86
BIOS Menu 20: CD/DVD Drives	87
BIOS Menu 21: Security	87
BIOS Menu 22: Chipset	89
BIOS Menu 23: Northbridge Chipset Configuration	89
BIOS Menu 24: Northbridge Chipset Configuration	91
BIOS Menu 25: Southbridge Chipset Configuration	92
BIOS Menu 26: Exit	93

Chapter

1

Introduction

1.1 Introduction

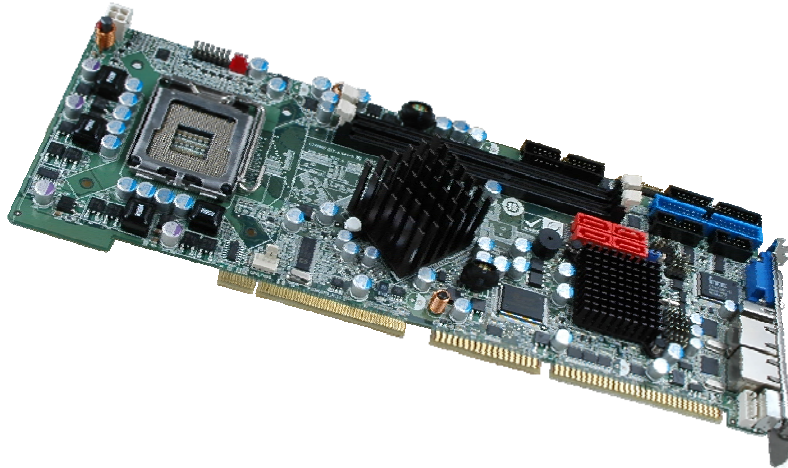

Figure 1-1: WSB-G41A

The WSB-G41A is a PCIMG 1.0 CPU card with an 800/1066/1333 MHz front side bus. The LGA775 accepts Intel® Core™2 Duo/Quad/Extreme processors and the card supports two DDR3 DIMMs up to 2.0 GB each (4.0 GB total). The WSB-G41A includes VGA video output and an optional DVI output. Expansion cards may be added to the expansion card slots on the backplane. Other features include floppy disk connector, IDE connector, 4 x SATA, dual Gigabit LAN, digital I/O, two serial ports, one parallel port and seven USB ports.

1.2 Benefits

Some of the WSB-G41A motherboard benefits include:

- Powerful graphics
- Staying connected with both wired LAN connections
- Speedy running of multiple programs and applications

1.3 Features

Some of the WSB-G41A motherboard features are listed below:

- PCIMG 1.0
- RoHS compliant
- LGA775 CPU socket

WSB-G41A CPU Card

- Supports two DDR3 DIMMs
- Two Gigabit Ethernet connectors
- Four SATA connectors
- High Definition audio to connect to an optional audio kit

1.4 Connectors

The connectors on the WSB-G41A are shown in the figure below.

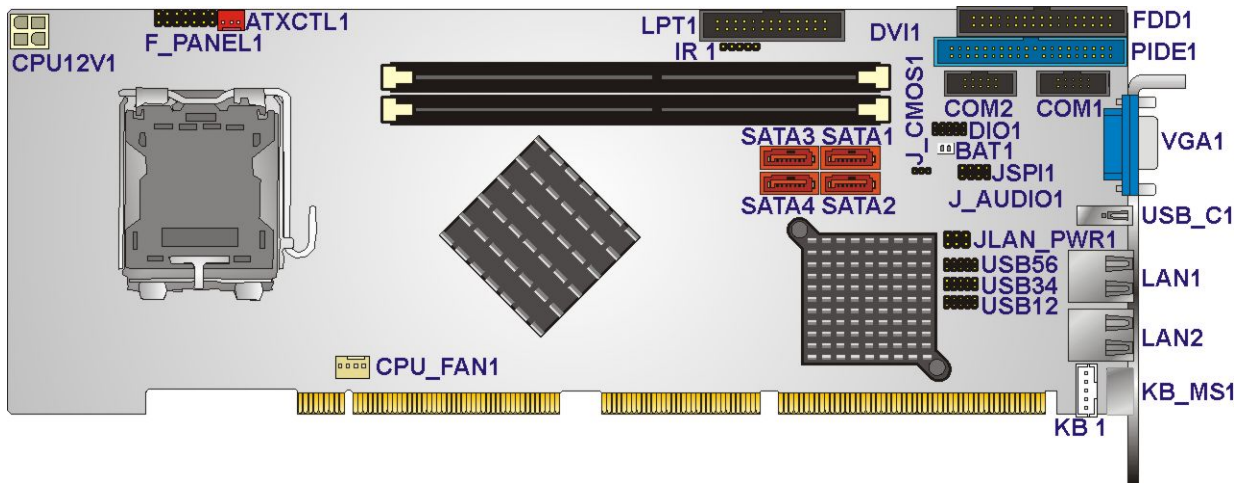

Figure 1-2: Connectors

1.5 Dimensions

The main dimensions of the WSB-G41A are shown in the diagram below.

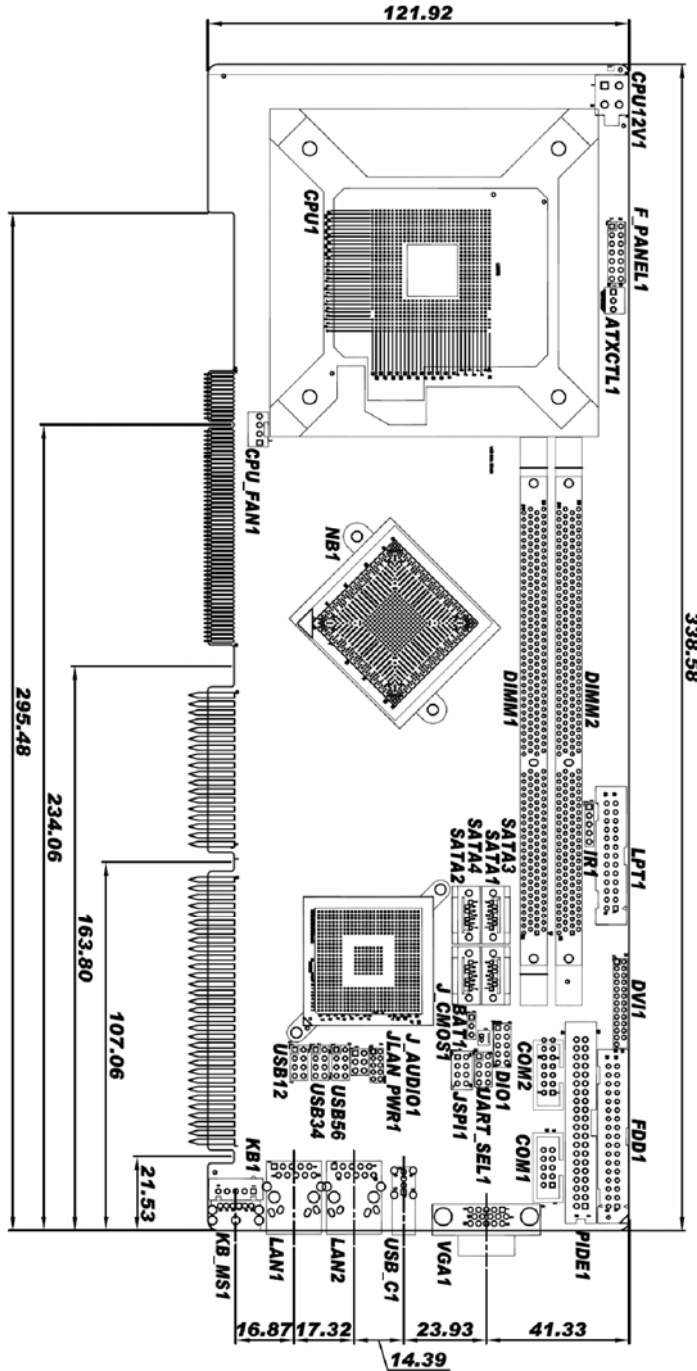

Figure 1-3: Dimensions (mm)

WSB-G41A CPU Card

1.6 Data Flow

Figure 1-4 shows the data flow between the system chipset, the CPU and other components installed on the motherboard.

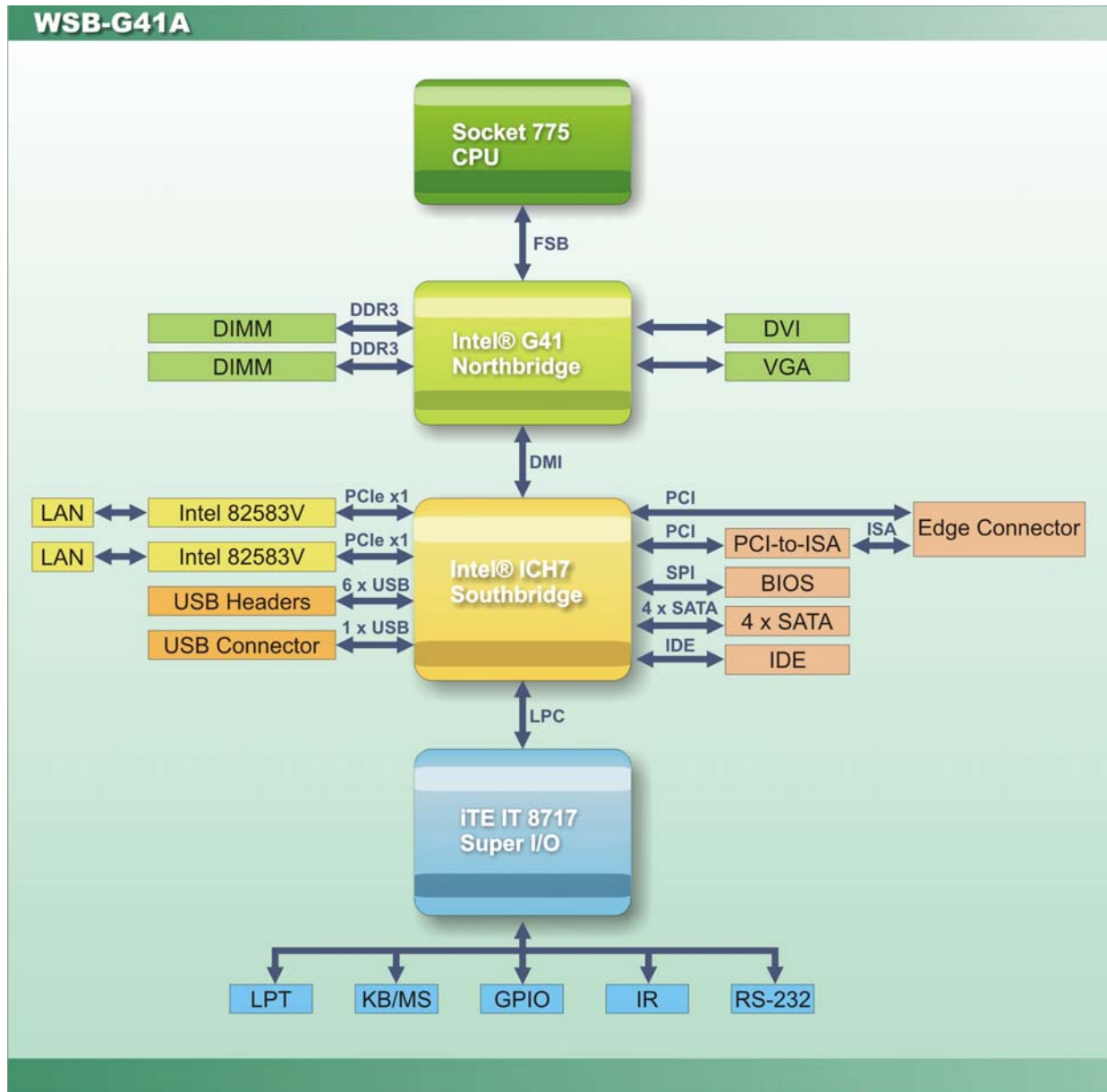

Figure 1-4: Data Flow Diagram

1.7 Technical Specifications

WSB-G41A technical specifications are shown below.

Specification	WSB-G41A
Form Factor	PCIMG 1.0
CPU Supported	Socket LGA775 Intel® Core™2 Duo/Quad/Extreme, Celeron
Front Side Bus (FSB)	800/1066/1333 MHz
Northbridge Chipset	Intel® G41
Integrated Graphics	VGA DVI (WSB-G41A-DVI only)
Memory	Two DDR3 modules up to 2 GB each (4 GB total)
Southbridge Chipset	Intel® ICH7
BIOS	AMI BIOS
Digital I/O	8-bit, 4-bit input/4-bit output
Ethernet Controllers	Dual Realtek RTL8111CP
Super I/O Controller	iTE IT8718F
Watchdog Timer	Software programmable supports 1~255 sec. system reset
Audio Connectors	One internal audio connector
Keyboard/Mouse	One external PS/2, one internal pin header
Serial Ports	Two RS-232 COM connectors
USB 2.0/1.1 ports	Six internal via pin header One external
Floppy Disk Drives	One floppy disk drive (FDD) connector
IDE	One IDE connector
Serial ATA	Four independent SATA channels with 3.0 Gb/s data transfer rates
Environmental and Power Specifications	
Power Supply	ATX supported

WSB-G41A CPU Card

Specification	WSB-G41A
Power Consumption	5 V @ 7.13 A 12 V @ 0.27 A 5VBS @ 0.11 A Vcore @ 3.02 A 3D Mark2001SE with Intel® Core™2 Duo E8500 3.16GHz and two 2GB DDR3 modules
Operating temperature	0°C ~ 60°C(32°F ~ 140°F), requires cooler and silicone heat sink paste
Humidity	5% ~ 95% (non-condensing)
Physical Specifications	
Dimensions	338 mm x 122 mm
Gross Weight	1.1 kg

Table 1-1: Technical Specifications

Chapter

2

Packing List

WSB-G41A CPU Card

2.1 Anti-static Precautions



WARNING!

Static electricity can destroy certain electronics. Make sure to follow the ESD precautions to prevent damage to the product, and injury to the user.

Make sure to adhere to the following guidelines:

- ***Wear an anti-static wristband:*** Wearing an anti-static wristband can prevent electrostatic discharge.
- ***Self-grounding:*** Touch a grounded conductor every few minutes to discharge any excess static buildup.
- ***Use an anti-static pad:*** When configuring any circuit board, place it on an anti-static mat.
- ***Only handle the edges of the PCB:*** Don't touch the surface of the motherboard. Hold the motherboard by the edges when handling.

2.2 Unpacking Precautions

When the WSB-G41A is unpacked, please do the following:

- Follow the antistatic guidelines above.
- Make sure the packing box is facing upwards when opening.
- Make sure all the packing list items are present.







2.3 Packing List



NOTE:

If any of the components listed in the checklist below are missing, do not proceed with the installation. Contact the IEI reseller or vendor the WSB-G41A was purchased from or contact an IEI sales representative directly by sending an email to sales@iei.com.tw.

The WSB-G41A is shipped with the following components:

Quantity	Item and Part Number	Image
1	WSB-G41A / WSB-G41A-DVI	
1	Dual RS-232 cable (with bracket) (P/N: 19800-000051-RS)	
4	SATA cable (P/N: 32000-062800-RS)	
1	Keyboard and mouse Y cable (P/N: 32000-133200-RS)	
1	USB cable (P/N: CB-USB02-RS)	
1	IO-KIT-001-R20 (only with DVI model)	
1	Mini jumper pack (2.0mm) (P/N:33100-000033-RS)	

WSB-G41A CPU Card





Quantity	Item and Part Number	Image
1	Utility CD	
1	Quick Installation Guide	

Table 2-1: Packing List

2.4 Optional Items

The following are optional components which may be separately purchased:

Item and Part Number	Image
CPU cooler kit (P/N: CF-520-RS-R11)	
CPU cooler kit (P/N: CF-775A-RS)	
ATA66 cable (P/N: 32200-000052-RS)	
FDD cable (P/N: 32200-000017-RS)	

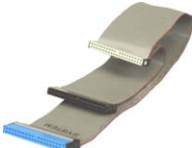
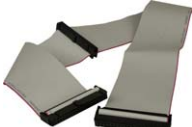



Item and Part Number	Image
LPT cable (P/N: 19800-000049-RS)	
Audio kit_ 5.1 Channel (P/N: AC-KIT08R-R10)	
Audio kit_ 7.1 Channel (P/N: AC-KIT-883HD-R10)	
SATA power cable (P/N: 32100-088600-RS 32102-000100-100-RS 32102-000100-200-RS)	

Table 2-2: Optional Items

Chapter

3

Connectors

3.1 Peripheral Interface Connectors

This chapter details all the jumpers and connectors.

3.1.1 Layout

The figure below shows all the connectors and jumpers.

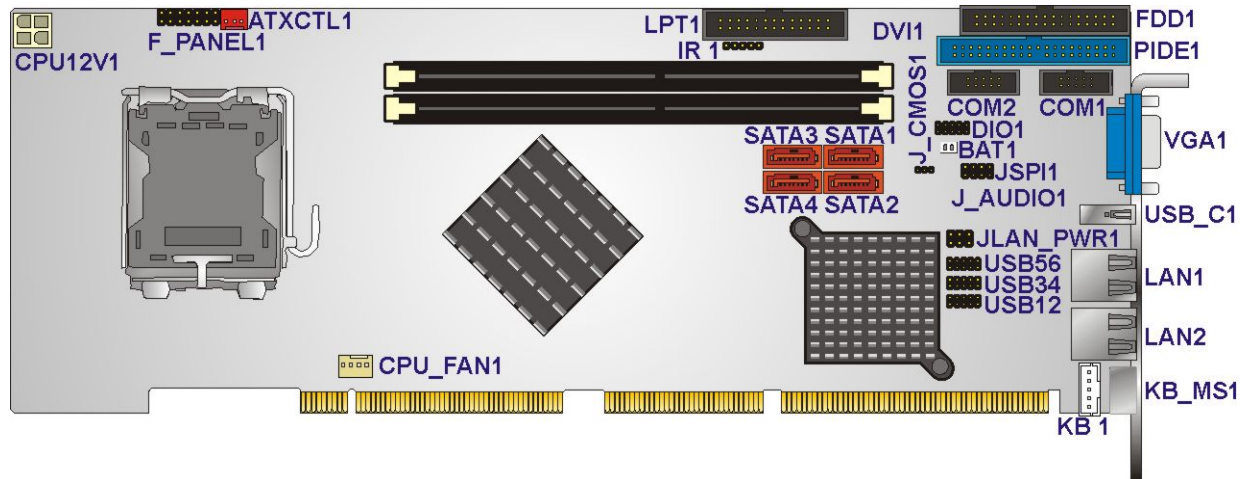

Figure 3-1: Connectors and Jumpers

3.1.2 Peripheral Interface Connectors

The table below lists all the connectors on the board.

Connector	Type	Label
ATX Power Control Connector	3-pin wafer (1x3)	ATXCTL1
Audio Kit Connector	9-pin header	J_AUDIO1
Battery Connector	2-pin wafer (1x2)	BAT1
CPU Fan Connector	4-pin header	CPU_FAN1
CPU Power Input Connector	4-pin connector	CPU12V1
DVI Connector	26-pin header	DVI1
Digital I/O Connector	10-pin header	DIO1
Floppy Disk Connector	34-pin header	FDD1
Front Panel Connector	14-pin header	F_PANEL1

WSB-G41A CPU Card

Connector	Type	Label
Infrared Interface Connector	5-pin header (1x5)	IR1
Keyboard Connector	5-pin header (1x5)	KB1
Memory Slot	DIMM slot	DIMM1, DIMM2
IDE Connector	40-pin box header	PIDE1
Parallel Port Connector	26-pin box header	LPT1
SATA Drive Connectors	7-pin SATA drive connectors	SATA1, SATA2, SATA3, SATA4
Serial Port Connector	10-pin box header	COM1, COM2
SPI Flash Connector	8-pin header	JSPI1
USB Connectors	8-pin header	USB12, USB34, USB56

Table 3–1: Internal Peripheral Connectors

3.1.3 External Interface Panel Connectors

The table below lists the connectors on the external I/O panel.

Connector	Type	Label
Keyboard/Mouse Connector	PS/2	KB_MS1
LAN Connector	RJ-45	LAN1, LAN2
USB Connector	USB port	USB_C1
VGA Connector	15-pin Female	VGA1

Table 3–2: External Peripheral Connectors

3.2 Internal Peripheral Connectors

The section describes all of the connectors on the WSB-G41A.

3.2.1 ATX Power Control Connector

CN Label: ATXCTL1

CN Type: 3-pin wafer (1x3)

CN Location: See **Figure 3-2**

CN Pinouts: See **Table 3-3**

The connector is for enabling an ATX power supply. When connected to the power supply, the power can be turned on and off with the front panel switch.

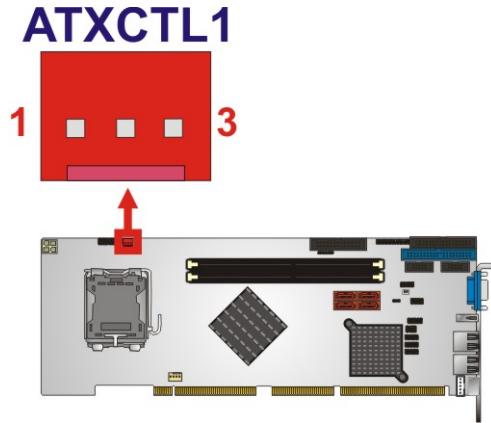

Figure 3-2: ATX Power Supply Enable Connector Location

Pin	Description
1	GND
2	ATX_ON
3	5VSB

Table 3-3: ATX Power Supply Enable Connector Pinouts

3.2.2 Audio Kit Connector

CN Label: J_AUDIO1

CN Type: 9-pin header

CN Location: See **Figure 3-3**

CN Pinouts: See **Table 3-4**

This connector connects to an external audio kit.

WSB-G41A CPU Card

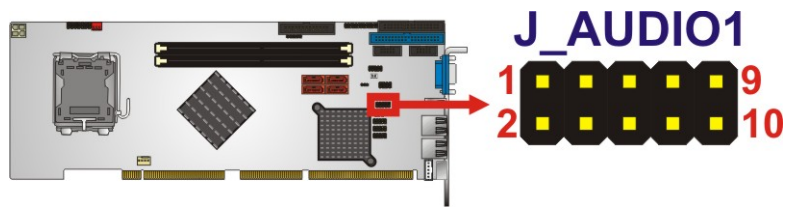

Figure 3-3: Audio Kit Connector Location

Pin	Description	Pin	Description
1	SYNC	2	BITCLK
3	SDOUT	4	PCBEEP
5	SDIN	6	RST#
7	VCC	8	GND
9	+12 V		

Table 3-4: Audio Kit Connector Pinouts

3.2.3 Battery Connector

- CN Label:** BAT1
- CN Type:** 2-pin wafer (1x2)
- CN Location:** See **Figure 3-4**
- CN Pinouts:** See **Table 3-5**

This is connected to the system battery. The battery provides power to the system clock to retain the time when power is turned off.

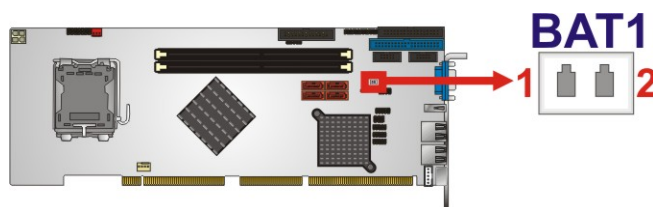

Figure 3-4: Battery Connector Location

Pin	Description
1	Battery+

Pin	Description
2	Ground

Table 3-5: Battery Connector Pinouts

3.2.4 CPU Fan Connector

- CN Label:** CPU_FAN1
- CN Type:** 4-pin header
- CN Location:** See **Figure 3-5**
- CN Pinouts:** See **Table 3-6**

The fan connector attaches to a CPU cooling fan.

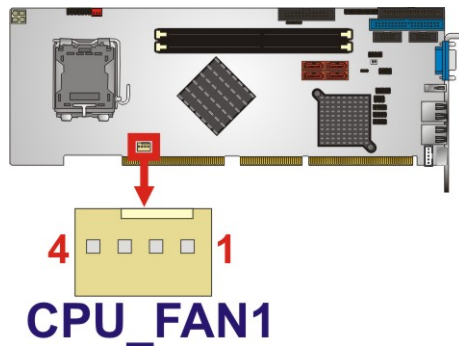
Figure 3-5: CPU Fan Connector Location

Pin	Description
1	GND
2	+12 V
3	Rotation signal
4	Control

Table 3-6: CPU Fan Connector Pinouts

3.2.5 CPU Power Input Connector

- CN Label:** CPU12V1
- CN Type:** 4-pin connector

WSB-G41A CPU Card

CN Location: See **Figure 3-6**

CN Pinouts: See **Table 3-7**

The CPU power input connector provides power to the CPU.

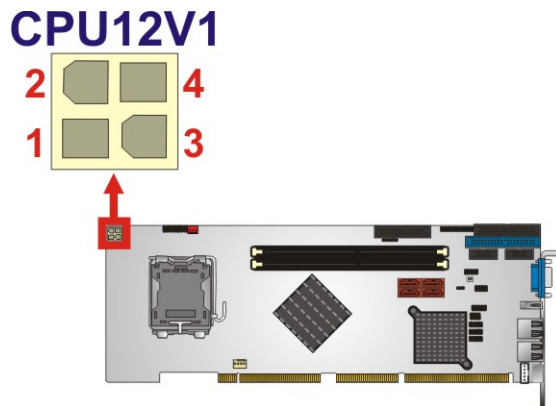

Figure 3-6: CPU Power Input Connector Location

Pin	Description
1	GND
2	GND
3	12 V
4	12 V

Table 3-7: CPU Power Input Connector Pinouts

3.2.6 DVI Connector

CN Label: **DVI1**

CN Type: 26-pin header

CN Location: See **Figure 3-7**

CN Pinouts: See **Table 3-8**

The DVI connector connects to a monitor that supports DVI video input.

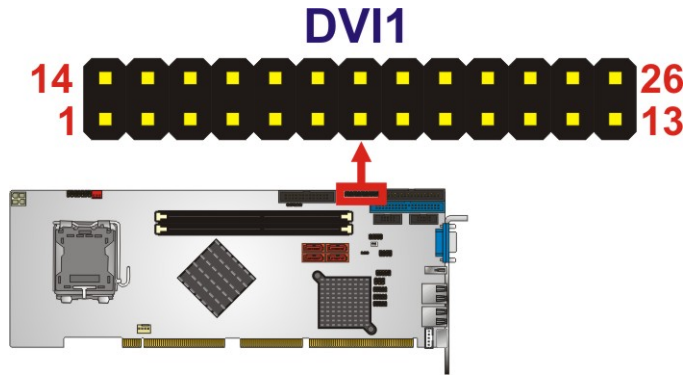

Figure 3-7: DVI Connector Location

Pin	Description	Pin	Description
1	Data 2-	14	+5 V Power
2	Data 2+	15	GND
3	GND	16	Hot Plug Detect
4	N/C	17	Data0-
5	N/C	18	Data 0+
6	DDC Clock	19	GND
7	DDC Data	20	N/C
8	N/C	21	N/C
9	Data 1-	22	GND
10	Data 1+	23	Clock+
11	GND	24	Clock-
12	N/C	25	GND
13	N/C	26	

Table 3-8: DVI Connector Pinouts

3.2.7 Digital I/O Connector

- CN Label:** DIO1
- CN Type:** 10-pin header
- CN Location:** See **Figure 3-8**
- CN Pinouts:** See **Table 3-9**

WSB-G41A CPU Card

The digital I/O connector provides programmable input and output for external devices.
The digital I/O provides 4-bit output and 4-bit input.

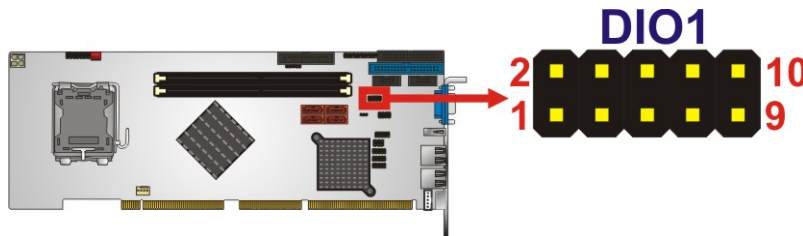

Figure 3-8: Digital I/O Connector Locations

Pin	Description	Pin	Description
1	GND	2	VCC
3	Output 3	4	Output 2
5	Output 1	6	Output 0
7	Input 3	8	Input 2
9	Input 1	10	Input 0

Table 3-9: Digital I/O Connector Pinouts

3.2.8 Floppy Disk Connector

- CN Label:** FDD1
- CN Type:** 34-pin header
- CN Location:** See **Figure 3-9**
- CN Pinouts:** See **Table 3-10**

The floppy disk connector is connected to a floppy disk drive.

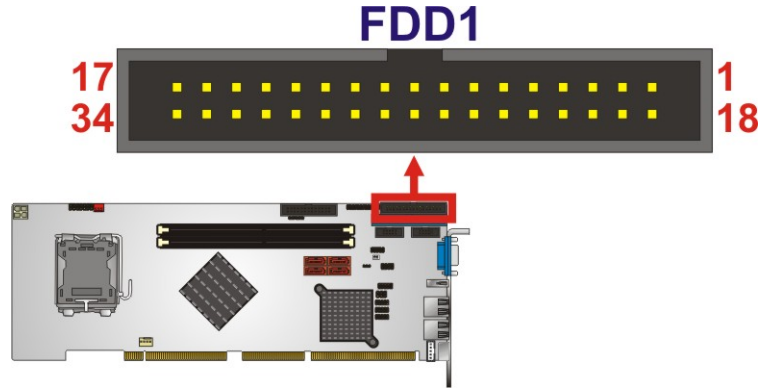

Figure 3-9: Floppy Drive Connector Location

Pin	Description	Pin	Description
1	GND	2	REDUCE WRITE
3	GND	4	N/C
5	N/C	6	N/C
7	GND	8	INDEX#
9	GND	10	MOTOR ENABLE A#
11	GND	12	DRIVE SELECT B#
13	GND	14	DRIVE SELECT A#
15	GND	16	MOTOR ENABLE B#
17	GND	18	DIRECTION#
19	GND	20	STEP#
21	GND	22	WRITE DATA#
23	GND	24	WRITE GATE#
25	GND	26	TRACK 0#
27	GND	28	WRITE PROTECT#
29	GND	30	READ DATA#
31	GND	32	SIDE 1 SELECT#
33	GND	34	DISK CHANGE#

Table 3-10: Floppy Drive Connector Pinouts

3.2.9 Front Panel Connector

CN Label: F_PANEL1

WSB-G41A CPU Card

- CN Type:** 14-pin header
- CN Location:** See **Figure 3-10**
- CN Pinouts:** See **Table 3-11**

The front panel connector connects to the indicator LEDs and buttons on the computer's front panel.

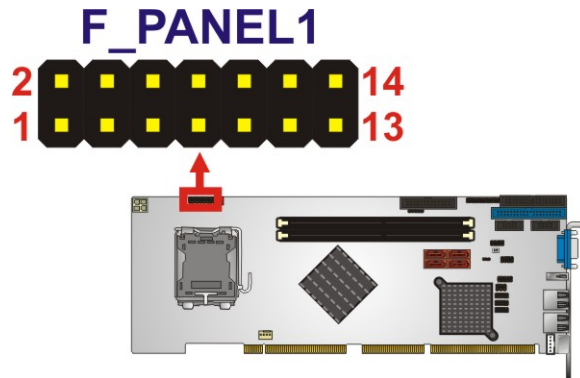

Figure 3-10: Front Panel Connector Location

Pin	Description	Pin	Description
1	Power LED+	2	Speaker+
3	N/C	4	N/C
5	Power LED-	6	N/C
7	Power button+	8	Speaker-
9	Power button-	10	N/C
11	HDD LED+	12	Reset+
13	HDD LED-	14	Reset-

Table 3-11: Front Panel Connector Pinouts

3.2.10 Infrared Interface Connector

- CN Label:** IR1
- CN Type:** 5-pin header (1x5)
- CN Location:** See **Figure 3-11**
- CN Pinouts:** See **Table 3-12**

The infrared connector attaches to an infrared receiver for use with remote controls.

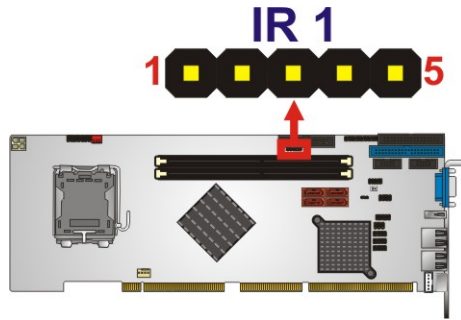

Figure 3-11: Infrared Connector Location

Pin	Description
1	VCC
2	NC
3	IR-RX
4	GND
5	IR-TX

Table 3-12: Infrared Connector Pinouts

3.2.11 Keyboard Connector

- CN Label:** KB1
- CN Type:** 5-pin header (1x5)
- CN Location:** See **Figure 3-12**
- CN Pinouts:** See **Table 3-13**

The keyboard connector can be used to install a PS/2 keyboard.

WSB-G41A CPU Card

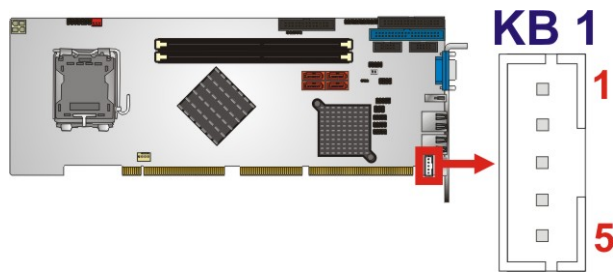

Figure 3-12: Keyboard Connector Location

Pin	Description
1	KEYBOARD CLOCK
2	KEYBOARD DATA
3	N/C
4	GROUND
5	VCC

Table 3-13: Keyboard Connector Pinouts

3.2.12 Memory Slot

CN Label: DIMM1, DIMM2

CN Type: DIMM slot

CN Location: See Figure 3-13

The DIMM slots are for DIMM memory modules.

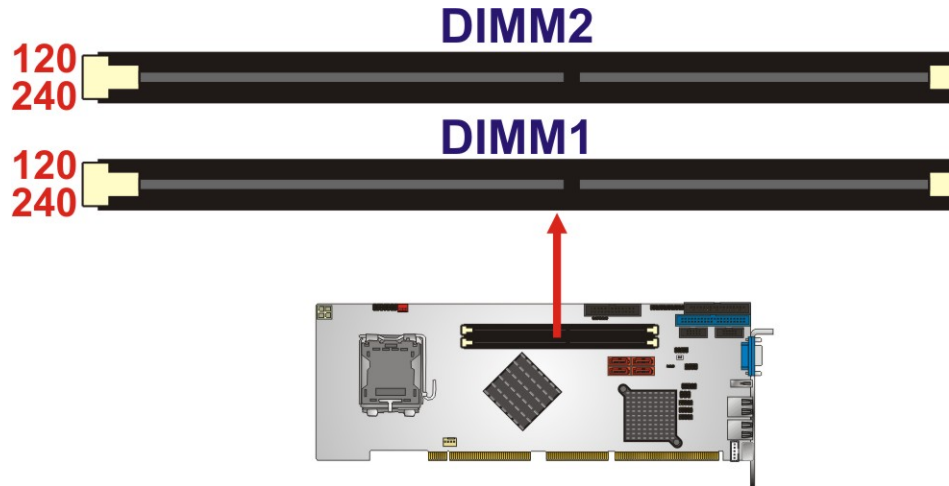

Figure 3-13: Memory Card Slot Location

3.2.13 IDE Connector

- CN Label:** PIDE1
- CN Type:** 40-pin box header
- CN Location:** See Figure 3-14
- CN Pinouts:** See Table 3-14

Connects to IDE hard drives and optical drives.

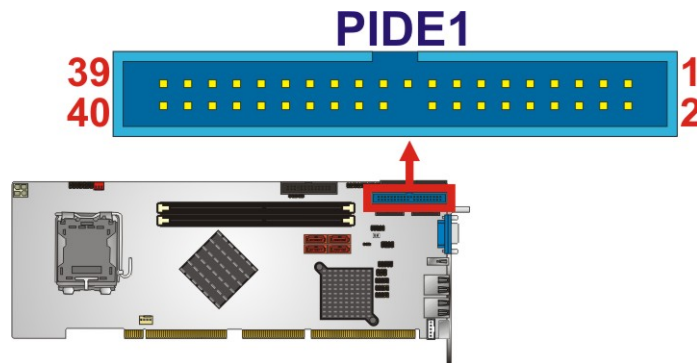

Figure 3-14: IDE Connector Location

Pin	Description	Pin	Description
1	RESET#	2	GROUND
3	DATA 7	4	DATA 8

WSB-G41A CPU Card

Pin	Description	Pin	Description
5	DATA 6	6	DATA 9
7	DATA 5	8	DATA 10
9	DATA 4	10	DATA 11
11	DATA 3	12	DATA 12
13	DATA 2	14	DATA 13
15	DATA 1	16	DATA 14
17	DATA 0	18	DATA 15
19	GROUND	20	N/C
21	IDE DRQ	22	GROUND
23	IOW#	24	GROUND
25	IOR#	26	GROUND
27	IDE CHRDY	28	GROUND
29	IDE DACK	30	GROUND-DEFAULT
31	INTERRUPT	32	N/C
33	SA1	34	N/C
35	SA0	36	SA2
37	HDC CS0#	38	HDC CS1#
39	HDD ACTIVE#	40	GROUND

Table 3-14: IDE Connector Pinouts

3.2.14 Parallel Port Connector

- CN Label:** LPT1
- CN Type:** 26-pin box header
- CN Location:** See **Figure 3-15**
- CN Pinouts:** See **Table 3-15**

The parallel port connector connects to a parallel port connector interface or some other parallel port device such as a printer.

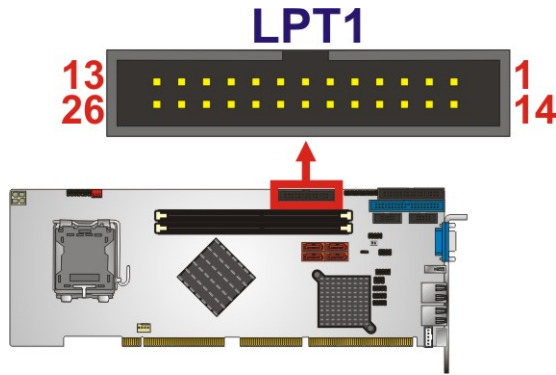

Figure 3-15: Parallel Port Connector Location

Pin	Description	Pin	Description
1	STROBE#	14	AUTO FORM FEED#
2	DATA0	15	ERROR#
3	DATA1	16	INITIALIZE#
4	DATA2	17	PRINTER SELECT LN#
5	DATA3	18	GROUND
6	DATA4	19	GROUND
7	DATA5	20	GROUND
8	DATA6	21	GROUND
9	DATA7	22	GROUND
10	ACKNOWLEDGE	23	GROUND
11	BUSY	24	GROUND
12	PAPER EMPTY	25	GROUND
13	PRINTER SELECT		

Table 3-15: Parallel Port Connector Pinouts

3.2.15 SATA Drive Connectors

CN Label: SATA1, SATA2, SATA3, SATA4

CN Type: 7-pin SATA drive connectors

CN Location: See **Figure 3-16**

The SATA drive connectors can be connected to SATA drives.

WSB-G41A CPU Card

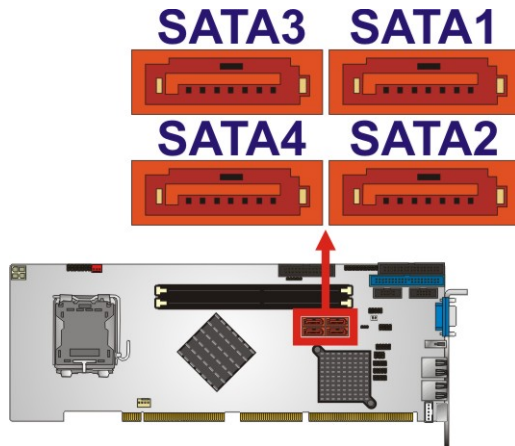

Figure 3-16: SATA Drive Connector Location

3.2.16 Serial Port Connector

- CN Label:** COM1, COM2
- CN Type:** 10-pin box header
- CN Location:** See **Figure 3-17**
- CN Pinouts:** See **Table 3-16**

This connector provides RS-232 communications.

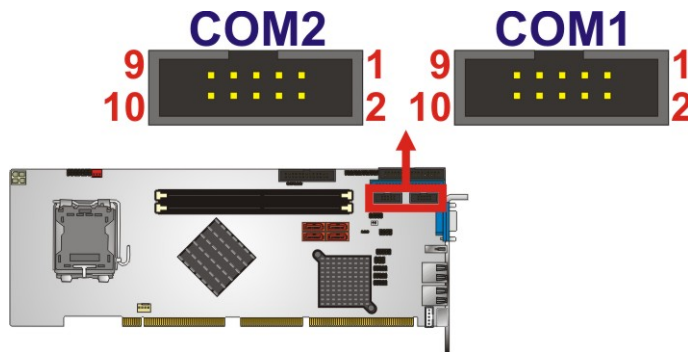

Figure 3-17: Serial Port Connector Location

Pin	Description
1	Data Carrier Direct (DCD)
2	Receive Data (RXD)

Pin	Description
3	Transmit Data (TXD)
4	Data Terminal Ready (DTR)
5	Ground (GND)
6	Data Set Ready (DSR)
7	Request To Send (RTS)
8	Clear To Send (CTS)
9	Ring Indicator (RI)
10	NC

Table 3-16: Serial Port Connector Pinouts

3.2.17 SPI Flash Connector

- CN Label:** JSPI1
- CN Type:** 8-pin header
- CN Location:** See **Figure 3-18**
- CN Pinouts:** See **Table 3-17**

The 8-pin SPI Flash connector is used to flash the BIOS.

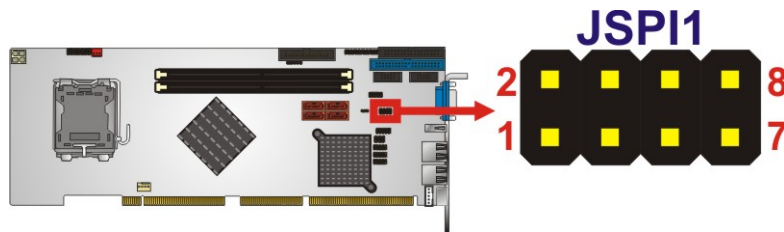

Figure 3-18: SPI Flash Connector

Pin	Description	Pin	Description
1	VCC	2	GND
3	CS#	4	CLOCK
5	SO	6	SI
7	NC	8	NC

Table 3-17: SPI Flash Connector

WSB-G41A CPU Card

3.2.18 USB Connectors

CN Label: USB12, USB34, USB56

CN Type: 8-pin header

CN Location: See **Figure 3-19**

CN Pinouts: See **Table 3-18**

The USB connectors connect to USB devices. Each pin header provides two USB ports.

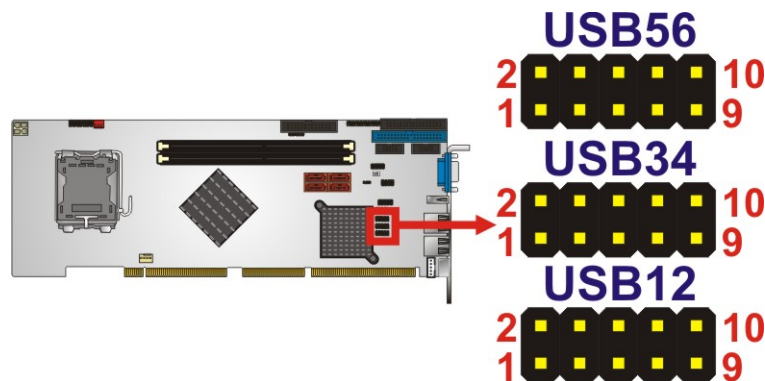

Figure 3-19: USB Connector Pinout Locations

Pin	Description	Pin	Description
1	VCC	2	GND
3	DATA1-	4	DATA2+
5	DATA1+	6	DATA2-
7	GND	8	VCC

Table 3-18: USB Port Connector Pinouts

3.3 External Peripheral Interface Connector Panel

The figure below shows the external peripheral interface connector (EPIC) panel. The EPIC panel consists of the following:

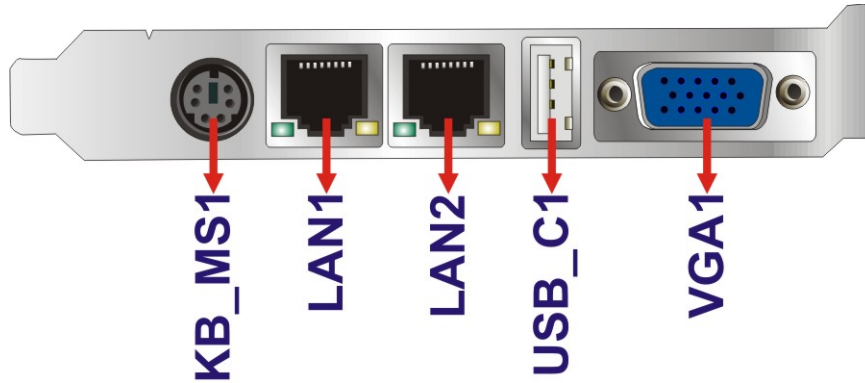

Figure 3-20: External Peripheral Interface Connector

3.3.1 Keyboard/Mouse Connector

- CN Label:** KB_MS1
- CN Type:** PS/2
- CN Location:** See **Figure 3-20**
- CN Pinouts:** See **Table 3-19, Figure 3-21**

The keyboard and mouse connector is a standard PS/2 connector.

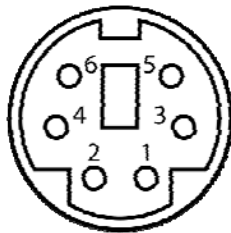

Figure 3-21: PS/2 Pinout and Configuration

Pin	Description
1	KB DATA
2	MS DATA
3	GND
4	VCC
5	KB CLOCK

WSB-G41A CPU Card

Pin	Description
6	MS CLOCK

Table 3-19: Keyboard Connector Pinouts

3.3.2 LAN Connector

- CN Label:** LAN1, LAN2
- CN Type:** RJ-45
- CN Location:** See **Figure 3-20**
- CN Pinouts:** See **Table 3-20**

The LAN connector connects to a local network.

Pin	Description	Pin	Description
1	TXA+	5	TXC-
2	TXA-	6	TXB-
3	TXB+	7	TXD+
4	TXC+	8	TXD-

Table 3-20: LAN Pinouts

3.3.3 USB Connector

- CN Label:** USB_C1
- CN Type:** USB port
- CN Location:** See **Figure 3-20**
- CN Pinouts:** See **Table 3-21**

The USB connector can be connected to a USB device.

Pin	Description	Pin	Description
1	5 V	2	5 V
3	DATA-	4	DATA-
5	DATA+	6	DATA+

Pin	Description	Pin	Description
7	GND	8	GND

Table 3-21: USB Port Pinouts

3.3.4 VGA Connector

- CN Label:** VGA1
- CN Type:** 15-pin Female
- CN Location:** See **Figure 3-20**
- CN Pinouts:** See **Figure 3-22** and **Table 3-22**

The VGA connector connects to a monitor that accepts a standard VGA input.

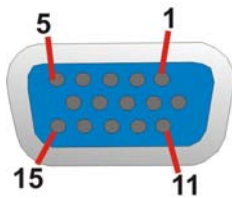
Figure 3-22: VGA Connector

Pin	Description	Pin	Description
1	RED	2	GREEN
3	BLUE	4	NC
5	GND	6	GND
7	GND	8	GND
9	VCC / NC	10	GND
11	NC	12	DDC DAT
13	HSYNC	14	VSYNC
15	DDCCLK		

Table 3-22: VGA Connector Pinouts

Chapter

4

Installation

4.1 Anti-static Precautions



WARNING:

Failure to take ESD precautions during the installation of the WSB-G41A may result in permanent damage to the WSB-G41A and severe injury to the user.

Electrostatic discharge (ESD) can cause serious damage to electronic components, including the WSB-G41A. Dry climates are especially susceptible to ESD. It is therefore critical that whenever the WSB-G41A or any other electrical component is handled, the following anti-static precautions are strictly adhered to.

- **Wear an anti-static wristband:** Wearing a simple anti-static wristband can help to prevent ESD from damaging the board.
- **Self-grounding:** Before handling the board, touch any grounded conducting material. During the time the board is handled, frequently touch any conducting materials that are connected to the ground.
- **Use an anti-static pad:** When configuring the WSB-G41A, place it on an anti-static pad. This reduces the possibility of ESD damaging the WSB-G41A.
- **Only handle the edges of the PCB:** When handling the PCB, hold the PCB by the edges.

4.2 Installation Considerations



NOTE:

The following installation notices and installation considerations should be read and understood before installation. All installation notices must be strictly adhered to. Failing to adhere to these precautions may lead to severe damage and injury to the person performing the installation.

WSB-G41A CPU Card



WARNING:

The installation instructions described in this manual should be carefully followed in order to prevent damage to the components and injury to the user.

Before and during the installation please **DO** the following:

- Read the user manual:
 - The user manual provides a complete description of the WSB-G41A installation instructions and configuration options.
- Wear an electrostatic discharge cuff (ESD):
 - Electronic components are easily damaged by ESD. Wearing an ESD cuff removes ESD from the body and helps prevent ESD damage.
- Place the WSB-G41A on an antistatic pad:
 - When installing or configuring the motherboard, place it on an antistatic pad. This helps to prevent potential ESD damage.
- Turn all power to the WSB-G41A off:
 - When working with the WSB-G41A, make sure that it is disconnected from all power supplies and that no electricity is being fed into the system.

Before and during the installation of the WSB-G41A **DO NOT:**

- Remove any of the stickers on the PCB board. These stickers are required for warranty validation.
- Use the product before verifying all the cables and power connectors are properly connected.
- Allow screws to come in contact with the PCB circuit, connector pins, or its components.

4.3 Basic Installation

This section outlines the parts that must be installed for the system to function correctly.

4.3.1 CPU Installation

**NOTE:**

To enable Hyper-Threading, the CPU and chipset must both support it.

**WARNING:**

CPUs are expensive and sensitive components. When installing the CPU please be careful not to damage it in anyway. Make sure the CPU is installed properly and ensure the correct cooling kit is properly installed.

The LGA775 socket is shown in **Figure 4-1**.

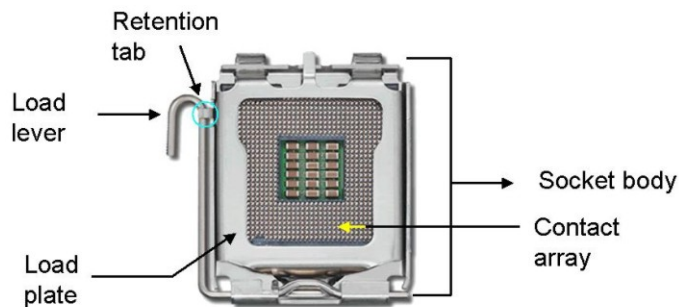

Figure 4-1: Intel LGA775 Socket

To install the CPU, follow the steps below.

**WARNING:**

DO NOT touch the pins at the bottom of the CPU. When handling the CPU, only hold it on the sides.

WSB-G41A CPU Card

Step 1: Remove the protective cover. The black protective cover can be removed by pulling up on the tab labeled "Remove". See **Figure 4-2**.

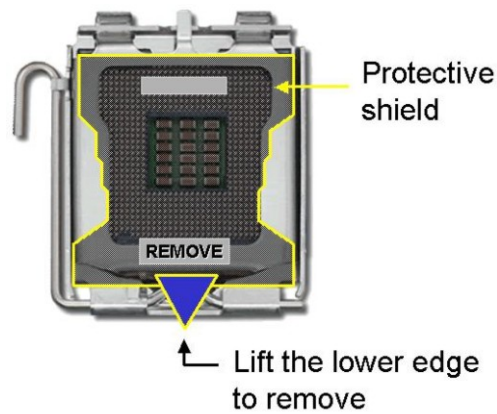

Figure 4-2: Remove Protective Cover

Step 2: Open the socket. Disengage the load lever by pressing the lever down and slightly outward to clear the retention tab. Fully open the lever, then open the load plate. See **Figure 4-3**.

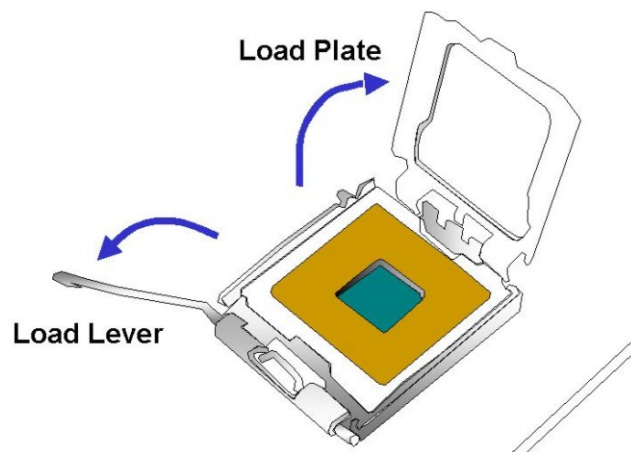

Figure 4-3: CPU Socket Load Plate

Step 3: Inspect the CPU socket. Make sure there are no bent pins and make sure the socket contacts are free of foreign material. If any debris is found, remove it with compressed air.

Step 4: Orientate the CPU properly. The contact array should be facing the CPU socket.

- Step 5:** Correctly position the CPU. Match the Pin 1 mark with the cut edge on the CPU socket.
- Step 6:** Align the CPU pins. Locate pin 1 and the two orientation notches on the CPU. Carefully match the two orientation notches on the CPU with the socket alignment keys.
- Step 7:** Insert the CPU. Gently insert the CPU into the socket. If the CPU pins are properly aligned, the CPU should slide into the CPU socket smoothly. See **Figure 4-4**.

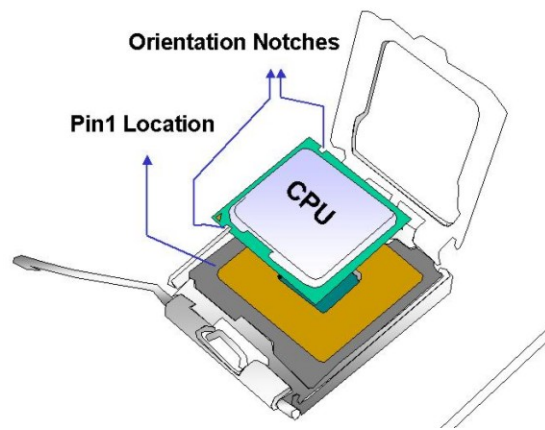

Figure 4-4: Insert the Socket LGA775 CPU

- Step 8:** Close the CPU socket. Close the load plate and engage the load lever by pushing it back to its original position. There will be some resistance, but will not require extreme pressure.
- Step 9:** Connect the 12 V power to the board. Connect the 12 V power from the power supply to the board.

WSB-G41A CPU Card

4.3.2 Cooling Kit Installation



WARNING:

DO NOT use the original Intel® heat sink and fan. A proprietary one is recommended.

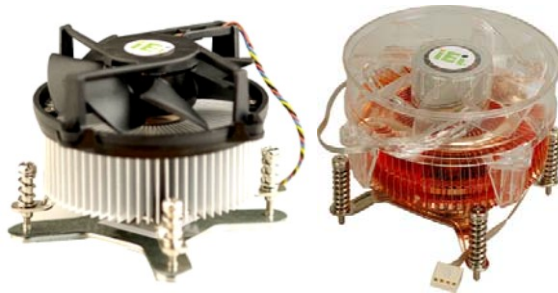

Figure 4-5: Cooling Kits

The cooling kit can be bought from IEI. The cooling kit has a heatsink and fan.



WARNING:

Do not wipe off (accidentally or otherwise) the pre-sprayed layer of thermal paste on the bottom of the heat sink. The thermal paste between the CPU and the heat sink is important for optimum heat dissipation.

To install the cooling kit, follow the instructions below.

- Step 1:** Place the cooling kit onto the socket LGA775 CPU. Make sure the CPU cable can be properly routed when the cooling kit is installed.
- Step 2:** Properly align the cooling kit. Make sure the four spring screw fasteners can pass through the pre-drilled holes on the PCB.

Step 3: Mount the cooling kit. Gently place the cooling kit on top of the CPU. Make sure the four threaded screws on the corners of the cooling kit properly pass through the predrilled holes on the bottom of the PCB.

Step 4: Secure the cooling kit. From the solder side of the PCB, align the support bracket to the screw threads on heat sink that were inserted through the PCB holes. (See **Figure 4-6**)

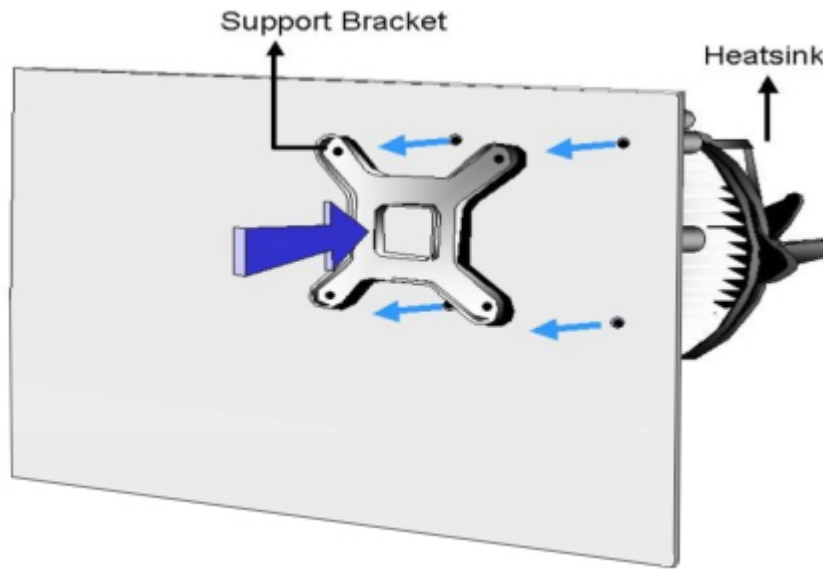

Figure 4-6: Securing the Heat sink to the WSB-G41A

Step 5: Tighten the screws. Use a screwdriver to tighten the four screws. Tighten each nut a few turns at a time and do not over-tighten the screws.

Step 6: Connect the fan cable. Connect the cooling kit fan cable to the fan connector on the WSB-G41A. Carefully route the cable and avoid heat generating chips and fan blades.

4.3.3 DIMM Installation

To install a DIMM, please follow the steps below and refer to **Figure 4-7**.

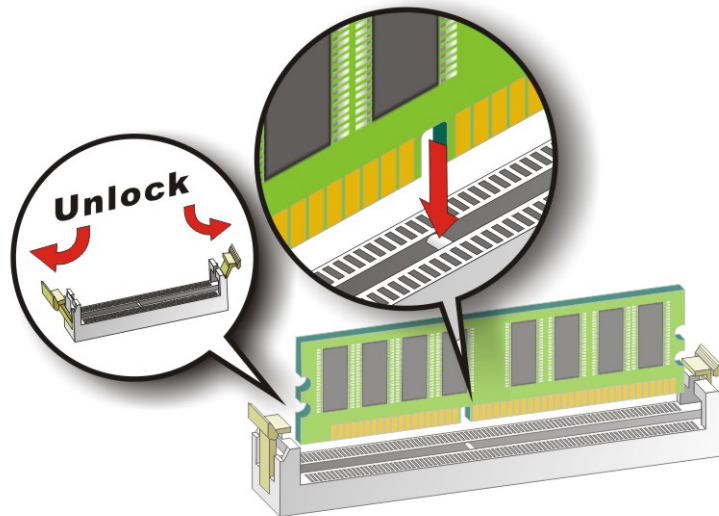

Figure 4-7: DIMM Installation

- Step 1: Open the DIMM socket handles.** Open the two handles outwards as far as they can. See **Figure 4-7**.
- Step 2: Align the DIMM with the socket.** Align the DIMM so the notch on the memory lines up with the notch on the memory socket. See **Figure 4-7**.
- Step 3: Insert the DIMM.** Once aligned, press down until the DIMM is properly seated. Clip the two handles into place. See **Figure 4-7**.
- Step 4: Removing a DIMM.** To remove a DIMM, push both handles outward. The memory module is ejected by a mechanism in the socket.

4.3.4 Backplane Installation

Before the WSB-G41A can be installed into the chassis, a backplane must first be installed. Please refer to the installation instructions that came with the backplane and the chassis to see how to install the backplane into the chassis.



NOTE:

IEI has a wide range of backplanes available. Please contact your WSB-G41A vendor, reseller or and IEI sales representative at sales@iei.com.tw or visit the IEI website at <http://www.ieiworld.com> to find out more about the available chassis.

4.3.5 CPU Card Installation

To install the WSB-G41A CPU card onto the backplane, carefully align the CPU card interface connectors with the corresponding socket on the backplane. To do this, please refer to the reference material that came with the backplane. Next, secure the CPU card to the chassis. To do this, please refer to the reference material that came with the chassis.

4.4 Jumper Settings



NOTE:

A jumper is a metal bridge used to close an electrical circuit. It consists of two or three metal pins and a small metal clip (often protected by a plastic cover) that slides over the pins to connect them. To CLOSE/SHORT a jumper means connecting the pins of the jumper with the plastic clip and to OPEN a jumper means removing the plastic clip from a jumper.

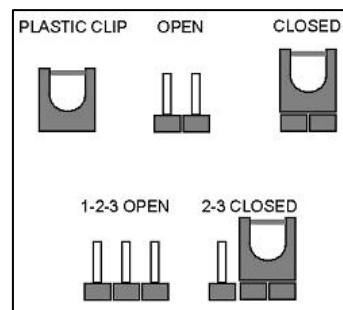

The WSB-G41A includes one jumper shown in **Table 4-1**.

Description	Label	Type
Clear CMOS jumper	J_CMOS1	3-pin header

Table 4-1: Jumpers

WSB-G41A CPU Card

4.4.1 Clear CMOS Jumper

Jumper Label:	J_CMOS1
Jumper Type:	3-pin header
Jumper Settings:	See Table 4-2
Jumper Location:	See Figure 4-8

To reset the BIOS, move the jumper to the "Clear BIOS" position for 3 seconds or more, and then move back to the default position.

Pin	Description
1-2	Normal
2-3	Clear BIOS

Table 4-2: Clear BIOS Jumper Settings

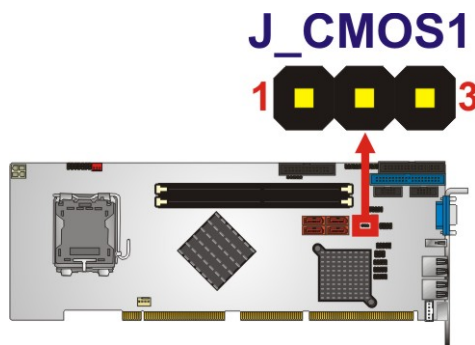

Figure 4-8: Clear BIOS Jumper Location

4.5 Internal Peripheral Device Connections

This section outlines the installation of peripheral devices to the onboard connectors.

4.5.1 SATA Drive Connection

The WSB-G41A is shipped with two SATA drive cables and one SATA drive power cable. To connect the SATA drives to the connectors, please follow the steps below.

Step 1: Locate the connectors. The locations of the SATA drive connectors are shown in **Chapter 3**.

Step 2: Insert the cable connector. Press the clip on the connector at the end of the SATA cable and insert the cable connector into the on-board SATA drive connector. See **Figure 4-9**.

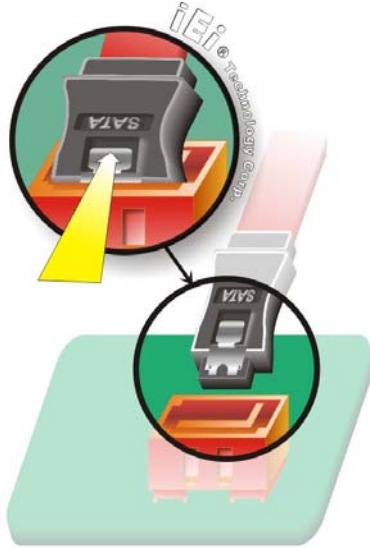

Figure 4-9: SATA Drive Cable Connection

Step 3: Connect the cable to the SATA disk. Connect the connector on the other end of the cable to the connector at the back of the SATA drive. See **Figure 4-10**.

Step 4: Connect the SATA power cable. Connect the SATA power connector to the back of the SATA drive. See **Figure 4-10**.

WSB-G41A CPU Card



Figure 4-10: SATA Power Drive Connection

4.5.2 USB Cable (Dual Port) with Slot Bracket

The WSB-G41A is shipped with a dual port USB 2.0 cable. To connect the USB cable connector, please follow the steps below.

Step 5: **Locate the connectors.** The locations of the USB connectors are shown in **Chapter 3**.



WARNING:

If the USB pins are not properly aligned, the USB device can burn out.

Step 6: **Align the connectors.** The cable has two connectors. Correctly align pin 1 on each cable connector with pin 1 on the WSB-G41A USB connector.

Step 7: **Insert the cable connectors** Once the cable connectors are properly aligned with the USB connectors on the WSB-G41A, connect the cable connectors to the on-board connectors. See **Figure 4-11**.

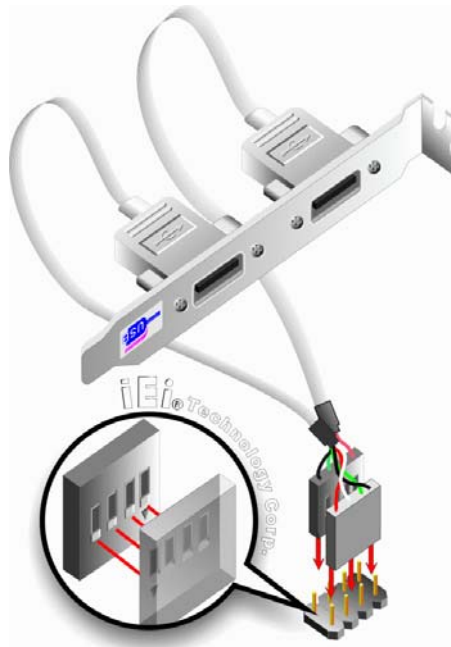

Figure 4-11: Dual USB Cable Connection

Step 8: Attach the bracket to the chassis. The USB 2.0 connectors are attached to a bracket. To secure the bracket to the chassis please refer to the installation instructions that came with the chassis.

4.6 External Peripheral Interface Connection

This section describes connecting devices to the external connectors on the WSB-G41A.

4.6.1 LAN Connection

There are two external RJ-45 LAN connectors. The RJ-45 connectors enable connection to an external network. To connect a LAN cable with an RJ-45 connector, please follow the instructions below.

Step 1: Locate the RJ-45 connectors. The locations of the USB connectors are shown in **Chapter 4**.

Step 2: Align the connectors. Align the RJ-45 connector on the LAN cable with one of the RJ-45 connectors on the WSB-G41A. See **Figure 4-12**.

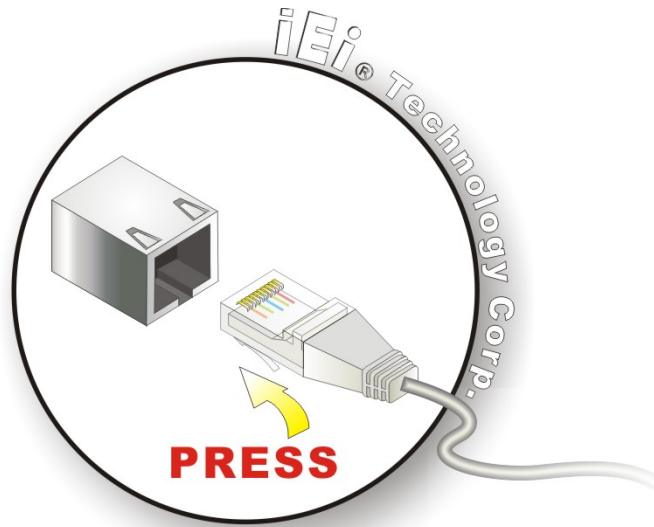

Figure 4-12: LAN Connection

Step 3: Insert the LAN cable RJ-45 connector. Once aligned, gently insert the LAN cable RJ-45 connector into the on-board RJ-45 connector.

4.6.2 USB Device Connection

There are two external USB 2.0 connectors. Both connectors are perpendicular to the WSB-G41A. To connect a USB 2.0 or USB 1.1 device, please follow the instructions below.

Step 1: Located the USB connectors. The locations of the USB connectors are shown in Chapter 4.

Step 2: Align the connectors. Align the USB device connector with one of the connectors on the WSB-G41A. See Figure 4-13.

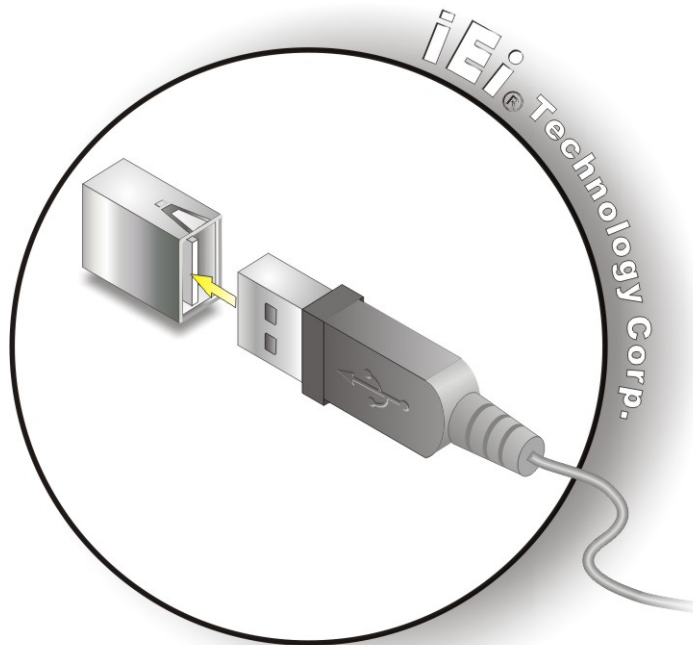

Figure 4-13: USB Device Connection

Step 3: **Insert the device connector.** Once aligned, gently insert the USB device connector into the on-board connector.

4.6.3 VGA Monitor Connection

The WSB-G41A has a single female DB-15 connector on the external peripheral interface panel. The DB-15 connector is connected to a CRT or VGA monitor. To connect a monitor to the WSB-G41A, please follow the instructions below.

- Step 1:** **Locate the female DB-15 connector.** The location of the female DB-15 connector is shown in **Chapter 3**.
- Step 2:** **Align the VGA connector.** Align the male DB-15 connector on the VGA screen cable with the female DB-15 connector on the external peripheral interface.
- Step 3:** **Insert the VGA connector** Once the connectors are properly aligned with the insert the male connector from the VGA screen into the female connector on the WSB-G41A. See **Figure 4-14**.

WSB-G41A CPU Card

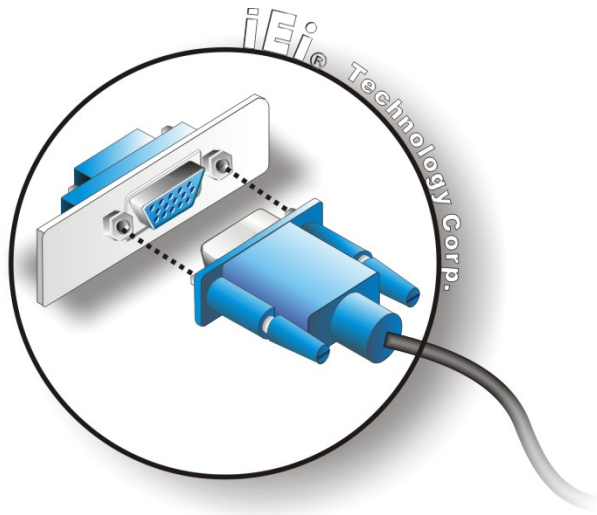

Figure 4-14: VGA Connector

Step 4: **Secure the connector.** Secure the DB-15 VGA connector from the VGA monitor to the external interface by tightening the two retention screws on either side of the connector.

4.7 Software Installation

All the drivers for the WSB-G41A are on the CD that came with the system. To install the drivers, please follow the steps below.

Step 1: Insert the CD into a CD drive connected to the system.



NOTE:

If the installation program doesn't start automatically:
Click "Start->My Computer->CD Drive->autorun.exe"

Step 2: The driver main menu appears (**Figure 4-15**).

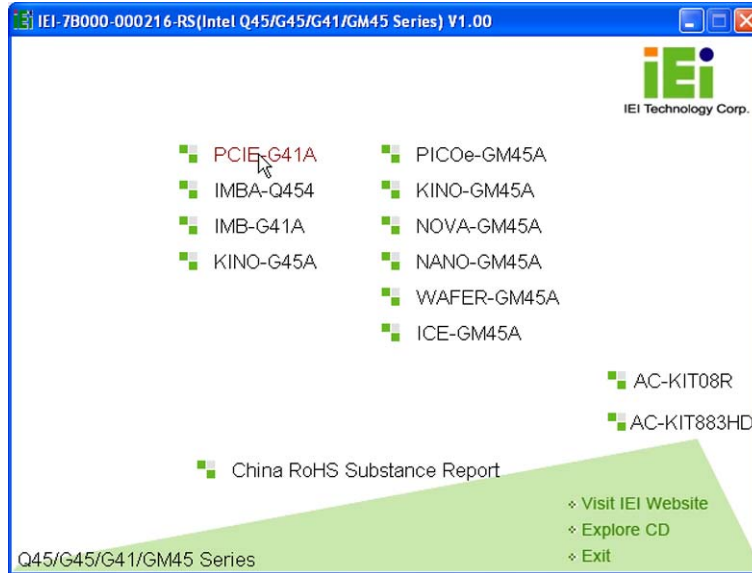

Figure 4-15: Introduction Screen

Step 3: Click WSB-G41A.

Step 4: A new screen with a list of available drivers appears (**Figure 4-16**).

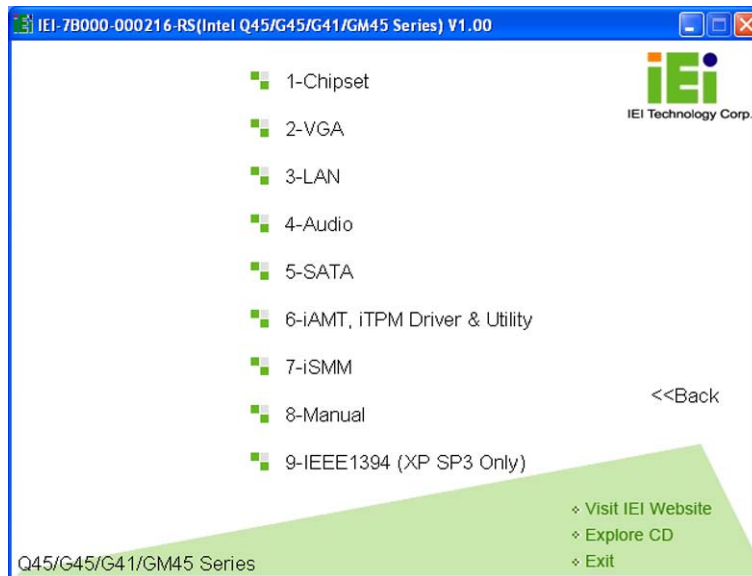

Figure 4-16: Available Drivers

Step 5: Install all of the necessary drivers in this menu.

Chapter

5

BIOS

5.1 Introduction

The BIOS is programmed onto the BIOS chip. The BIOS setup program allows changes to certain system settings. This chapter outlines the options that can be changed.

5.1.1 Starting Setup

The AMI BIOS is activated when the computer is turned on. The setup program can be activated in one of two ways.

1. Press the **DELETE** key as soon as the system is turned on or
2. Press the **DELETE** key when the “**Press Del to enter SETUP**” message appears on the screen.

If the message disappears before the **DELETE** key is pressed, restart the computer and try again.

5.1.2 Using Setup

Use the arrow keys to highlight items, press **ENTER** to select, use the PageUp and PageDown keys to change entries, press **F1** for help and press **Esc** to quit. Navigation keys are shown in.

Key	Function
Up arrow	Move to previous item
Down arrow	Move to next item
Left arrow	Move to the item on the left hand side
Right arrow	Move to the item on the right hand side
Esc key	Main Menu – Quit and not save changes into CMOS Status Page Setup Menu and Option Page Setup Menu -- Exit current page and return to Main Menu
Page Up key	Increase the numeric value or make changes
Page Dn key	Decrease the numeric value or make changes
F1 key	General help, only for Status Page Setup Menu and Option Page Setup Menu

WSB-G41A CPU Card

Key	Function
F2 /F3 key	Change color from total 16 colors. F2 to select color forward.
F10 key	Save all the CMOS changes, only for Main Menu

Table 5-1: BIOS Navigation Keys

5.1.3 Getting Help

When **F1** is pressed a small help window describing the appropriate keys to use and the possible selections for the highlighted item appears. To exit the Help Window press **Esc** or the **F1** key again.

5.1.4 Unable to Reboot after Configuration Changes

If the computer cannot boot after changes to the system configuration is made, CMOS defaults. Use the jumper described in Chapter 5.

5.1.5 BIOS Menu Bar

The **menu bar** on top of the BIOS screen has the following main items:

- Main – Changes the basic system configuration.
- Advanced – Changes the advanced system settings.
- PCIPnP – Changes the advanced PCI/PnP Settings
- Boot – Changes the system boot configuration.
- Security – Sets User and Supervisor Passwords.
- Chipset – Changes the chipset settings.
- Power – Changes power management settings.
- Exit – Selects exit options and loads default settings

The following sections completely describe the configuration options found in the menu items at the top of the BIOS screen and listed above.

5.2 Main

The **Main** BIOS menu (**BIOS Menu 1**) appears when the **BIOS Setup** program is entered. The **Main** menu gives an overview of the basic system information.

```

BIOS SETUP UTILITY
Main  Advanced  PCIPNP  Boot  Security  Chipset  Exit
-----
System Overview
-----
AMIBIOS
Version      :08.00.15
Build Date   :07/08/09
ID:          :B153MT11

Processor
Type         :Intel® Core™2 CPU   E8400 @ 3.00GHz
Speed        :3000MHz
Count        :1

System Memory
Size         :2014MB

System Time   [14:20:27]
System Time   [Tue 010/08/2009]

←→  Select Screen
↑↓  Select Item
Enter Go to SubScreen
F1   General Help
F10  Save and Exit
ESC  Exit

v02.61 ©Copyright 1985-2006, American Megatrends, Inc.

```

BIOS Menu 1: Main

→ System Overview

The **System Overview** lists a brief summary of different system components. The fields in **System Overview** cannot be changed. The items shown in the system overview include:

- AMI BIOS: Displays auto-detected BIOS information
 - **Version:** Current BIOS version
 - **Build Date:** Date the current BIOS version was made
 - **ID:** Installed BIOS ID
- Processor: Displays auto-detected CPU specifications
 - **Type:** Names the currently installed processor
 - **Speed:** Lists the processor speed
 - **Count:** The number of CPUs on the motherboard
- System Memory: Displays the auto-detected system memory.
 - **Size:** Lists memory size

WSB-G41A CPU Card

The System Overview field also has two user configurable fields:

→ **System Time [xx:xx:xx]**

Use the **System Time** option to set the system time. Manually enter the hours, minutes and seconds.

→ **System Date [xx/xx/xx]**

Use the **System Date** option to set the system date. Manually enter the day, month and year.

5.3 Advanced

Use the **Advanced** menu (**BIOS Menu 2**) to configure the CPU and peripheral devices through the following sub-menus:



WARNING!

Setting the wrong values in the sections below may cause the system to malfunction. Make sure that the settings made are compatible with the hardware.

-
- CPU Configuration (see **Section 5.3.1**)
 - IDE Configuration (see **Section 5.3.2**)
 - Floppy Configuration (see **Section 5.3.3**)
 - Super IO Configuration (see **Section 5.3.3**)
 - Hardware Health Configuration (see **Section 5.3.5**)
 - Power Configuration (see **Section**)
 - Remote Access Configuration (see **Section 5.3.7**)
 - USB Configuration (see **Section 5.3.8**)

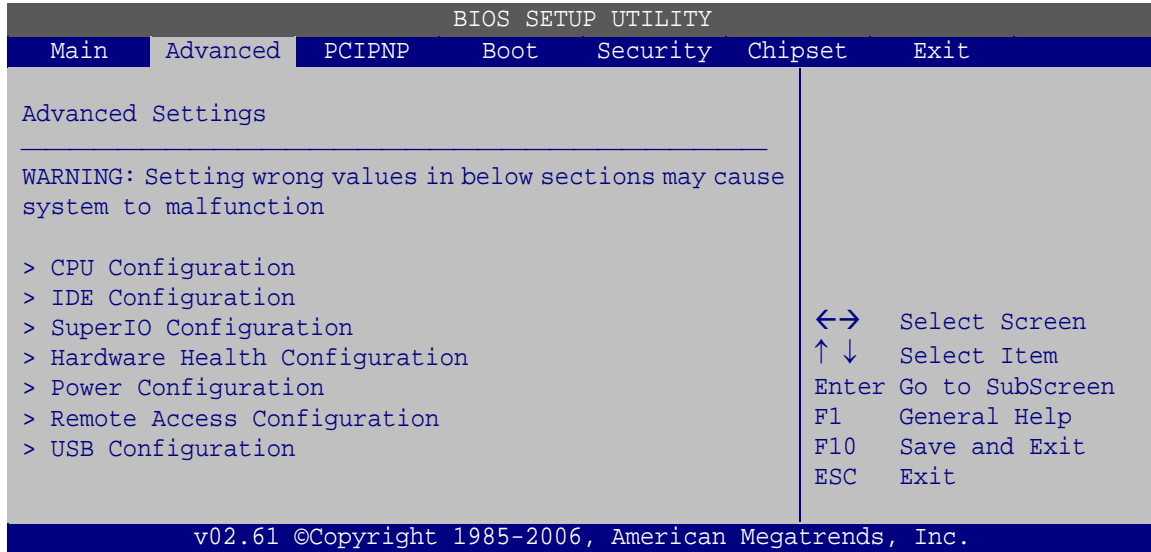
BIOS Menu 2: Advanced
5.3.1 CPU Configuration

Use the **CPU Configuration** menu (**BIOS Menu 3**) to view detailed CPU specifications and configure the CPU.

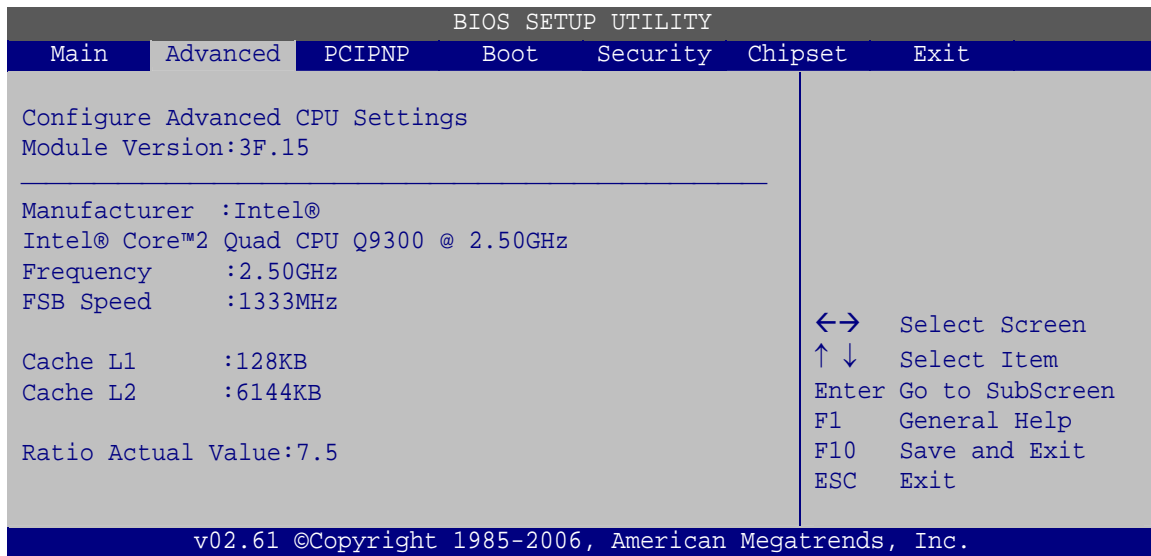
BIOS Menu 3: CPU Configuration

The CPU Configuration menu (**BIOS Menu 3**) lists the following CPU details:

- Manufacturer: Lists the name of the CPU manufacturer
- Brand String: Lists the brand name of the CPU being used

WSB-G41A CPU Card

- Frequency: Lists the CPU processing speed
- FSB Speed: Lists the FSB speed
- Cache L1: Lists the CPU L1 cache size
- Cache L2: Lists the CPU L2 cache size

5.3.2 IDE Configuration

Use the **IDE Configuration** menu (**BIOS Menu 4**) to change and/or set the configuration of the IDE devices installed in the system.

```

BIOS SETUP UTILITY
Main  Advanced  PCIPNP  Boot  Security  Chipset  Exit
-----
IDE Configuration
-----
ATA/IDE Configuration          [Enhanced]
  Configure SATA as             [IDE]
  Configure SATA Channels       [Before PATA]

> Primary IDE Master           : [Not Detected]
> Primary IDE Slave            : [Not Detected]
> Secondary IDE Master         : [Not Detected]
> Secondary IDE Slave          : [Not Detected]
> Third IDE Master              : [Not Detected]
> Third IDE Slave              : [Not Detected]

<=> Select Screen
↑↓ Select Item
Enter Go to SubScreen
F1 General Help
F10 Save and Exit
ESC Exit

v02.61 ©Copyright 1985-2006, American Megatrends, Inc.
  
```

BIOS Menu 4: IDE Configuration

→ ATA/IDE Configurations [Compatible]

Use the **ATA/IDE Configurations** option to configure the ATA/IDE controller.

- **Disabled** Disables the on-board ATA/IDE controller.
- **Compatible** Configures the on-board ATA/IDE controller to be in compatible mode. In this mode, a SATA channel will replace one of the IDE channels. This mode supports up to 4 storage devices.

→ **Enhanced** **DEFAULT** Configures the on-board ATA/IDE controller to be in Enhanced mode. In this mode, IDE channels and SATA channels are separated. This mode supports up to 6 storage devices. Some legacy OS do not support this mode.

→ **Configure SATA as [IDE]**

Use the **Configure SATA as** option to configure SATA devices as normal IDE devices.

→ **IDE** **DEFAULT** Configures SATA devices as normal IDE device.

→ **Configure SATA Channels [Behind PATA]**

Use the **Configure SATA Channels** option to determine how SATA channels and PATA channels are ordered.

→ **Before PATA** Puts SATA channels before PATA channels.

→ **Behind PATA** **DEFAULT** Puts SATA channels behind PATA channels.

→ **IDE Master and IDE Slave**

When entering setup, BIOS automatically detects the presence of IDE devices. BIOS displays the status of the automatically detected IDE devices. The following IDE devices are detected and are shown in the **IDE Configuration** menu:

- Primary IDE Master
- Primary IDE Slave
- Secondary IDE Master
- Secondary IDE Slave
- Third IDE Master
- Third IDE Slave

The **IDE Configuration** menu (**BIOS Menu 4**) allows changes to the configurations for the IDE devices installed in the system. If an IDE device is detected and one of the above listed four BIOS configuration options are selected, the IDE configuration options shown in **Section 5.3.2.1** appear.

WSB-G41A CPU Card

5.3.2.1 IDE Master, IDE Slave

Use the **IDE Master** and **IDE Slave** configuration menu to view both primary and secondary IDE device details and configure the IDE devices connected to the system.

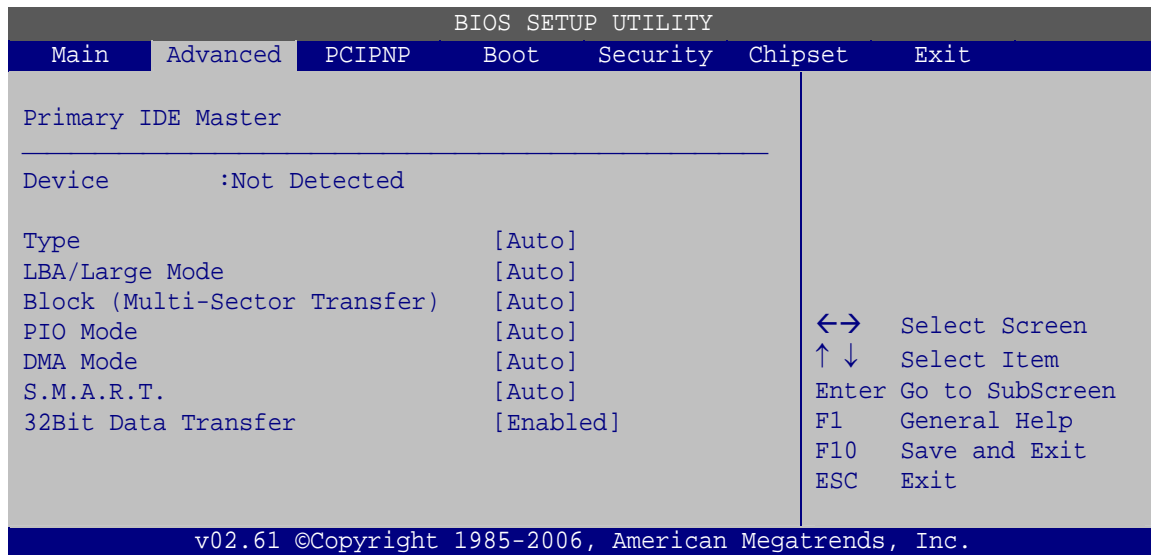

BIOS Menu 5: IDE Master and IDE Slave Configuration

→ Auto-Detected Drive Parameters

The “grayed-out” items in the left frame are IDE disk drive parameters automatically detected from the firmware of the selected IDE disk drive. The drive parameters are listed as follows:

- Device: Lists the device type (e.g. hard disk, CD-ROM etc.)
- Type: Indicates the type of devices a user can manually select
- Vendor: Lists the device manufacturer
- Size: List the storage capacity of the device.
- LBA Mode: Indicates whether the LBA (Logical Block Addressing) is a method of addressing data on a disk drive is supported or not.
- Block Mode: Block mode boosts IDE drive performance by increasing the amount of data transferred. Only 512 bytes of data can be transferred per interrupt if block mode is not used. Block mode allows transfers of up to 64 KB per interrupt.
- PIO Mode: Indicates the PIO mode of the installed device.

- Async DMA: Indicates the highest Asynchronous DMA Mode that is supported.
- Ultra DMA: Indicates the highest Synchronous DMA Mode that is supported.
- S.M.A.R.T.: Indicates whether or not the Self-Monitoring Analysis and Reporting Technology protocol is supported.
- 32Bit Data Transfer: Enables 32-bit data transfer.

→ Type [Auto]

Use the **Type** BIOS option select the type of device the AMIBIOS attempts to boot from after the Power-On Self-Test (POST) is complete.

- **Not Installed** BIOS is prevented from searching for an IDE disk drive on the specified channel.
- **Auto** **DEFAULT** The BIOS automatically detects the IDE disk drive type attached to the specified channel. This setting should be used if an IDE hard disk drive is attached to the specified channel.
- **CD/DVD** The CD/DVD option specifies that an IDE CD-ROM drive is attached to the specified IDE channel. The BIOS does not attempt to search for other types of IDE disk drives on the specified channel.
- **ARMD** This option specifies an ATAPI Removable Media Device. These include, but are not limited to:
 - ZIP
 - LS-120

→ LBA/Large Mode [Auto]

Use the **LBA/Large Mode** option to disable or enable BIOS to auto detects LBA (Logical Block Addressing). LBA is a method of addressing data on a disk drive. In LBA mode, the maximum drive capacity is 137 GB.

- **Disabled** BIOS is prevented from using the LBA mode control on the specified channel.

WSB-G41A CPU Card

→ **Auto** **DEFAULT** BIOS auto detects the LBA mode control on the specified channel.

→ **Block (Multi Sector Transfer) [Auto]**

Use the **Block (Multi Sector Transfer)** to disable or enable BIOS to auto detect if the device supports multi-sector transfers.

→ **Disabled** BIOS is prevented from using Multi-Sector Transfer on the specified channel. The data to and from the device occurs one sector at a time.

→ **Auto** **DEFAULT** BIOS auto detects Multi-Sector Transfer support on the drive on the specified channel. If supported the data transfer to and from the device occurs multiple sectors at a time.

→ **PIO Mode [Auto]**

Use the **PIO Mode** option to select the IDE PIO (Programmable I/O) mode program timing cycles between the IDE drive and the programmable IDE controller. As the PIO mode increases, the cycle time decreases.

→ **Auto** **DEFAULT** BIOS auto detects the PIO mode. Use this value if the IDE disk drive support cannot be determined.

→ **0** PIO mode 0 selected with a maximum transfer rate of 3.3 MB/s

→ **1** PIO mode 1 selected with a maximum transfer rate of 5.2 MB/s

→ **2** PIO mode 2 selected with a maximum transfer rate of 8.3 MB/s

→ **3** PIO mode 3 selected with a maximum transfer rate of 11.1 MB/s

→ **4** PIO mode 4 selected with a maximum transfer rate of 16.6 MB/s
(This setting generally works with all hard disk drives manufactured after 1999. For other disk drives, such as IDE CD-ROM drives, check the specifications of the drive.)

→ **DMA Mode [Auto]**

Use the **DMA Mode** BIOS selection to adjust the DMA mode options.

- **Auto** **DEFAULT** BIOS auto detects the DMA mode. Use this value if the IDE disk drive support cannot be determined.
- **SWDMA0** Single Word DMA mode 0 selected with a maximum data transfer rate of 2.1 MB/s
- **SWDMA1** Single Word DMA mode 1 selected with a maximum data transfer rate of 4.2 MB/s
- **SWDMA2** Single Word DMA mode 2 selected with a maximum data transfer rate of 8.3 MB/s
- **MWDMA0** Multi Word DMA mode 0 selected with a maximum data transfer rate of 4.2 MB/s
- **MWDMA1** Multi Word DMA mode 1 selected with a maximum data transfer rate of 13.3 MB/s
- **MWDMA2** Multi Word DMA mode 2 selected with a maximum data transfer rate of 16.6 MB/s
- **UDMA0** Ultra DMA mode 0 selected with a maximum data transfer rate of 16.6 MB/s
- **UDMA1** Ultra DMA mode 1 selected with a maximum data transfer rate of 25 MB/s
- **UDMA2** Ultra DMA mode 2 selected with a maximum data transfer rate of 33.3 MB/s
- **UDMA3** Ultra DMA mode 3 selected with a maximum data transfer rate of 44 MB/s (To use this mode, it is required that an 80-conductor ATA cable is used.)
- **UDMA4** Ultra DMA mode 4 selected with a maximum data transfer rate of 66.6 MB/s (To use this mode, it is required that an 80-conductor ATA cable is used.)

WSB-G41A CPU Card

- **UDMA5** Ultra DMA mode 5 selected with a maximum data transfer rate of 99.9 MB/s (To use this mode, it is required that an 80-conductor ATA cable is used.)

→ **S.M.A.R.T [Auto]**

Use the **S.M.A.R.T** option to auto-detect, disable or enable Self-Monitoring Analysis and Reporting Technology (SMART) on the drive on the specified channel. **S.M.A.R.T** predicts impending drive failures. The **S.M.A.R.T** BIOS option enables or disables this function.

- **Auto** **DEFAULT** BIOS auto detects HDD SMART support.
- **Disabled** Prevents BIOS from using the HDD SMART feature.
- **Enabled** Allows BIOS to use the HDD SMART feature

→ **32Bit Data Transfer [Enabled]**

Use the **32Bit Data Transfer** BIOS option to enables or disable 32-bit data transfers.

- **Disabled** Prevents the BIOS from using 32-bit data transfers.
- **Enabled** **DEFAULT** Allows BIOS to use 32-bit data transfers on supported hard disk drives.

5.3.3 Floppy Configuration

Use the **Floppy Configuration menu** to configure the floppy disk drive connected to the system.

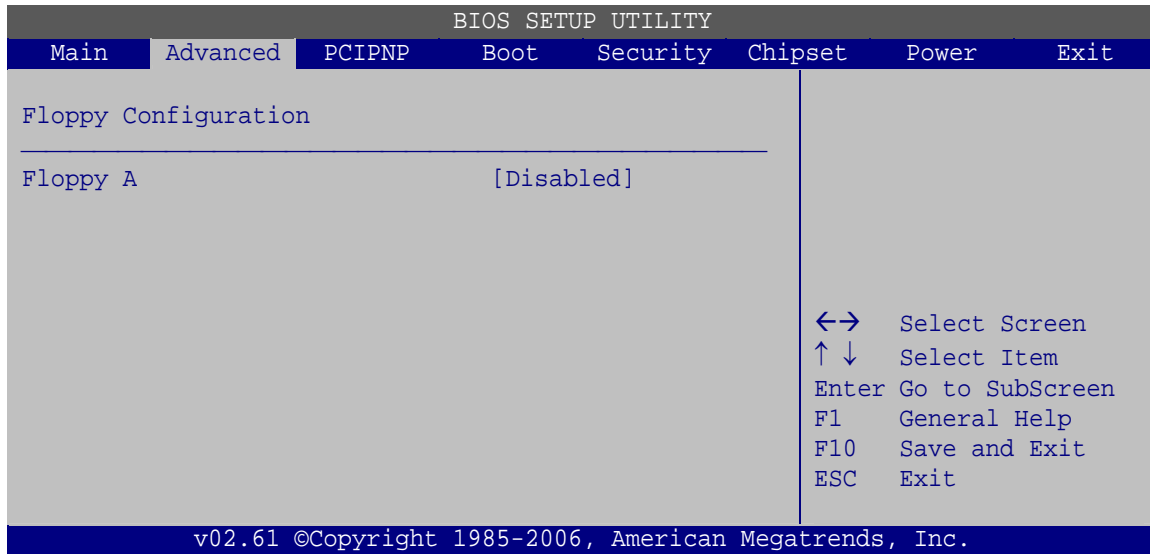

BIOS Menu 6: IDE Master and IDE Slave Configuration

→ Floppy A/B

Use the **Floppy A/B** option to configure the floppy disk drive. Options are listed below:

- Disabled
- 1.44 MB 3 1/2'

5.3.4 Super IO Configuration

Use the **Super IO Configuration** menu (**BIOS Menu 7**) to set or change the configurations for the FDD controllers, parallel ports and serial ports.

WSB-G41A CPU Card

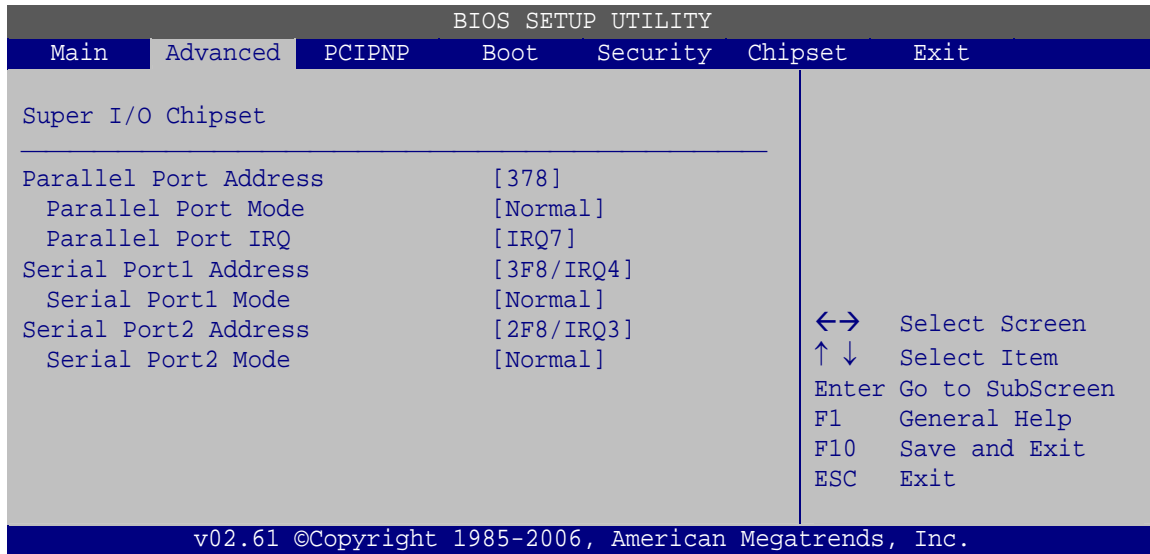

BIOS Menu 7: Super IO Configuration

→ Parallel Port Address [Disabled]

Use the **Parallel Port Address** option to select the parallel port base address.

- **Disabled** **DEFAULT** No base address is assigned to the Parallel Port
- **378** Parallel Port I/O port address is 378
- **278** Parallel Port I/O port address is 278
- **3BC** Parallel Port I/O port address is 3BC

→ Parallel Port Mode [Normal]

Use the **Parallel Port Mode** option to select the mode the parallel port operates in.

- **Normal** **DEFAULT** The normal parallel port mode is the standard mode for parallel port operation.
- **Bi-directional** Parallel port outputs are 8-bits long. Inputs are accomplished by reading 4 of the 8 bits on the status register.

→ **EPP**

The parallel port operates in the enhanced parallel port mode (EPP). The EPP mode supports bi-directional communication between the system and the parallel port device and the transmission rates between the two are much faster than the Normal mode.

→ **ECP+EPP**

The parallel port operates in the extended capabilities port (ECP) mode. The ECP mode supports bi-directional communication between the system and the parallel port device and the transmission rates between the two are much faster than the Normal mode

The parallel port is also be compatible with EPP devices described above

→ **Parallel Port IRQ [IRQ7]**

Use the **Parallel Port IRQ** selection to set the parallel port interrupt address.

→ **IRQ5** IRQ5 is assigned as the parallel port interrupt address

→ **IRQ7** **DEFAULT** IRQ7 is assigned as the parallel port interrupt address

→ **Serial Port1 Address [3F8/IRQ4]**

Use the **Serial Port1 Address** option to select the Serial Port 1 base address.

→ **Disabled** No base address is assigned to Serial Port 1

→ **3F8/IRQ4** **DEFAULT** Serial Port 1 I/O port address is 3F8 and the interrupt address is IRQ4

→ **3E8/IRQ4** Serial Port 1 I/O port address is 3E8 and the interrupt address is IRQ4

→ **2E8/IRQ3** Serial Port 1 I/O port address is 2E8 and the interrupt address is IRQ3

WSB-G41A CPU Card

→ Serial Port1 Mode [Normal]

Use the **Serial Port1 Mode** option to select the transmitting and receiving mode for the first serial port.

- **Normal** **DEFAULT** Serial Port 1 mode is normal
- **IrDA** Serial Port 1 mode is IrDA
- **ASK IR** Serial Port 1 mode is ASK IR

→ Serial Port2 Address [2F8/IRQ3]

Use the **Serial Port2 Address** option to select the Serial Port 2 base address.

- **Disabled** No base address is assigned to Serial Port 2
- **2F8/IRQ3** **DEFAULT** Serial Port 2 I/O port address is 3F8 and the interrupt address is IRQ3
- **3E8/IRQ4** Serial Port 2 I/O port address is 3E8 and the interrupt address is IRQ4
- **2E8/IRQ3** Serial Port 2 I/O port address is 2E8 and the interrupt address is IRQ3

→ Serial Port2 Mode [Normal]

Use the **Serial Port2 Mode** option to select the Serial Port2 operational mode.

- **Normal** **DEFAULT** Serial Port 2 mode is normal
- **IrDA** Serial Port 2 mode is IrDA
- **ASK IR** Serial Port 2 mode is ASK IR

5.3.5 Hardware Health Configuration

The **Hardware Health Configuration** menu (**BIOS Menu 8**) shows the operating temperature, fan speeds and system voltages.

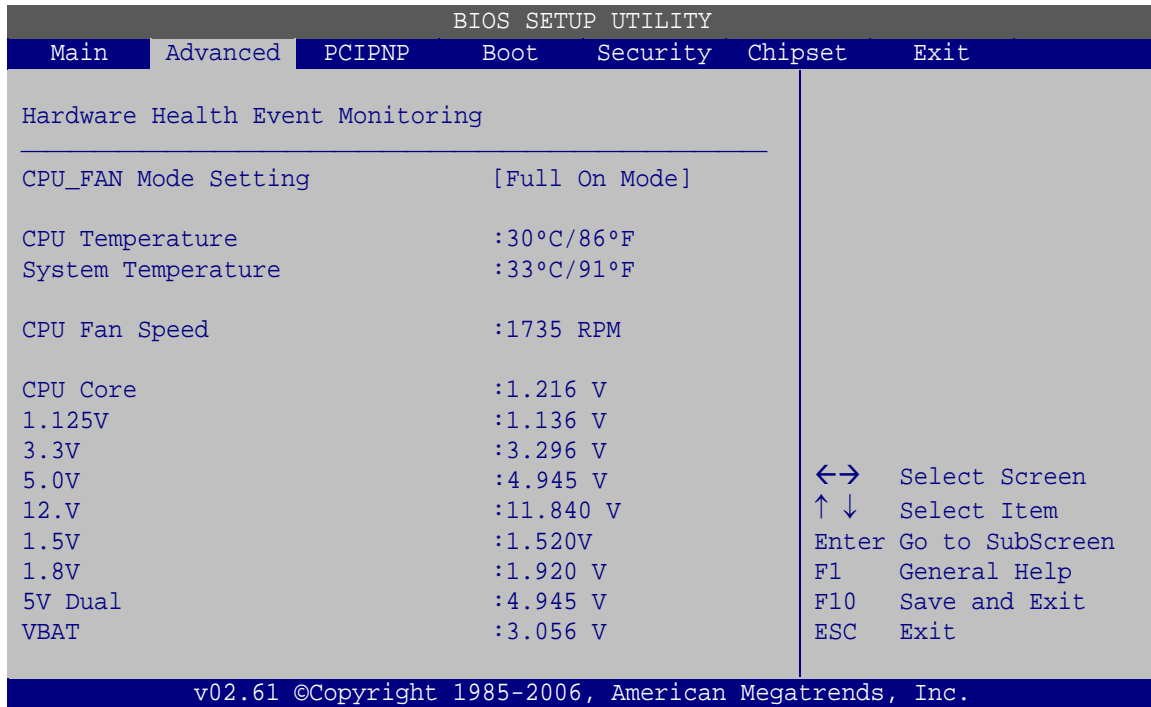

BIOS Menu 8: Hardware Health Configuration

→ Mode Setting [Full On Mode]

Use the **Mode Setting** option to configure the fan.

- **Full On Mode** **DEFAULT** Fan is on all the time
- **Automatic mode** The fan adjusts its speed using these settings:
 - Temp. Limit of OFF
 - Temp. Limit of Start
 - Fan Start PWM
 - Slope PWM 1
- **PWM Manual mode** The fan spins at the speed set in:
 - Fan PWM control

WSB-G41A CPU Card

→ Temp. Limit of OFF [000]



WARNING:

CPU failure can result if this value is set too high

The fan will turn off if the temperature falls below this value.

- Minimum Value: 0°C
- Maximum Value: 127°C

→ Temp. Limit of Start [020]



WARNING:

CPU failure can result if this value is set too high

When the fan is off, it will only start when the temperature exceeds this setting.

- Minimum Value: 0°C
- Maximum Value: 127°C

→ Start PWM [070]

This is the initial speed of the fan when it first starts spinning.

- PWM Minimum Mode: 0
- PWM Maximum Mode: 127

→ Slope PWM [1 PWM]

A bigger value will increase the fan speed in big amounts. A smaller value will increase the speed more gradually.

- 0 PWM
- 1 PWM
- 2 PWM

- 4 PWM
- 8 PWM
- 16 PWM
- 32 PWM
- 64 PWM

→ **CPU Fan PWM Control [070]**

This value specifies the speed of the fan.

- PWM Minimum Mode: 0
- PWM Maximum Mode: 127

→ **Hardware Health Monitoring**

The following system parameters and values are shown. The system parameters that are monitored are:

- System Temperatures:
 - CPU Temperature
 - System Temperature
- Fan Speeds:
 - CPU Fan Speed
 - SYS Fan Speed
- Voltages:
 - CPU Core
 - +1.125 V
 - +3.3 V
 - +5 V
 - +12 V
 - +1.5 V
 - +1.8 V
 - 5V Dual
 - VBAT

WSB-G41A CPU Card

5.3.6 Power Configuration

Use the **Power Configuration** menu (**BIOS Menu 10**) configures the Advanced Configuration and Power Interface (ACPI) and Power Management (APM) options.

```

BIOS SETUP UTILITY
Main  Advanced  PCIPNP  Boot  Security  Chipset  Exit
-----
Select AT/ATX Power          [ATX Power]
-----
> ACPI Configuration
> APM Configuration

<=> Select Screen
↑↓ Select Item
Enter Go to SubScreen
F1 General Help
F10 Save and Exit
ESC Exit

v02.61 ©Copyright 1985-2006, American Megatrends, Inc.
  
```

BIOS Menu 9: ACPI Configuration

5.3.6.1 ACPI Settings

Use the **General ACPI Settings** menu (**BIOS Menu 10**) to select the ACPI state when the system is suspended.

```

BIOS SETUP UTILITY
Main  Advanced  PCIPNP  Boot  Security  Chipset  Power  Exit
-----
ACPI Settings
-----
Suspend mode          [S1 (POS)]

<=> Select Screen
↑↓ Select Item
Enter Go to SubScreen
F1 General Help
F10 Save and Exit
ESC Exit

v02.61 ©Copyright 1985-2006, American Megatrends, Inc.
  
```

BIOS Menu 10: ACPI Settings

➔ **Suspend Mode [S1(POS)]**

Use the **Suspend Mode** option to specify the sleep state the system enters when it is not being used.

- ➔ **S1 (POS) DEFAULT** The system enters S1 (POS) sleep state. The system appears off. The CPU is stopped; RAM is refreshed; the system is running in a low power mode.

5.3.6.2 APM Configuration

The **APM Configuration** menu (**BIOS Menu 11**) allows the advanced power management options to be configured.

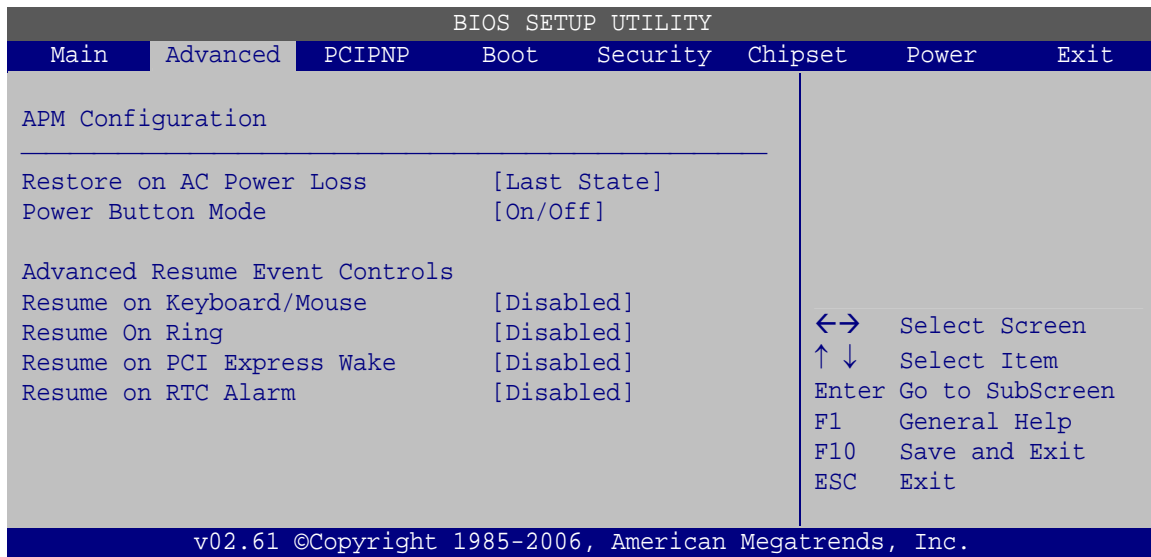

BIOS Menu 11: APM Configuration

➔ **Restore on AC Power Loss [Last State]**

Use the **Restore on AC Power Loss** BIOS option to specify what state the system returns to if there is a sudden loss of power to the system.

- ➔ **Power Off** The system remains turned off
- ➔ **Power On** The system turns on

WSB-G41A CPU Card

- **Last State** **DEFAULT** The system returns to its previous state. If it was on, it turns itself on. If it was off, it remains off.

→ **Resume on Keyboard/Mouse [Disabled]**

Use the **Resume on Keyboard/Mouse** BIOS option to enable activity on either the keyboard or mouse to rouse the system from a suspend or standby state. That is, the system is roused when the mouse is moved or a button on the keyboard is pressed.

- **Disabled** **DEFAULT** Wake event not generated by activity on the keyboard or mouse
- **Resume On Keyboard** Wake event generated by activity on the keyboard
- **Resume On Mouse** Wake event generated by activity on the mouse
- **Enabled** Wake event generated by activity on the keyboard or mouse

→ **Resume on Ring [Disabled]**

Use the **Resume on Ring** BIOS option to enable activity on the RI (ring in) modem line to rouse the system from a suspend or standby state. That is, the system will be roused by an incoming call on a modem.

- **Disabled** **DEFAULT** Wake event not generated by an incoming call
- **Enabled** Wake event generated by an incoming call

→ **Resume on PCI-Express WAKE# [Enabled]**

The **Resume on PCI-Express WAKE#** BIOS option specifies if the system is roused from a suspended or standby state when there is activity on the PCI-Express bus.

- **Disabled** Wake event not generated by PCI-Express activity
- **Enabled** **DEFAULT** Wake event generated by PCI-Express activity

→ Resume On RTC Alarm [Disabled]

Use the **Resume On RTC Alarm** option to specify the time the system should be roused from a suspended state.

- **Disabled** **DEFAULT** The real time clock (RTC) cannot generate a wake event

- **Enabled** If selected, the following appears with values that can be selected:
 RTC Alarm Date (Days)
 System Time
 After setting the alarm, the computer turns itself on from a suspend state when the alarm goes off.

5.3.7 Remote Access Configuration

Use the **Remote Access Configuration** menu (**BIOS Menu 12**) to configure remote access parameters. The **Remote Access Configuration** is an AMIBIOS feature and allows a remote host running a terminal program to display and configure the BIOS settings.

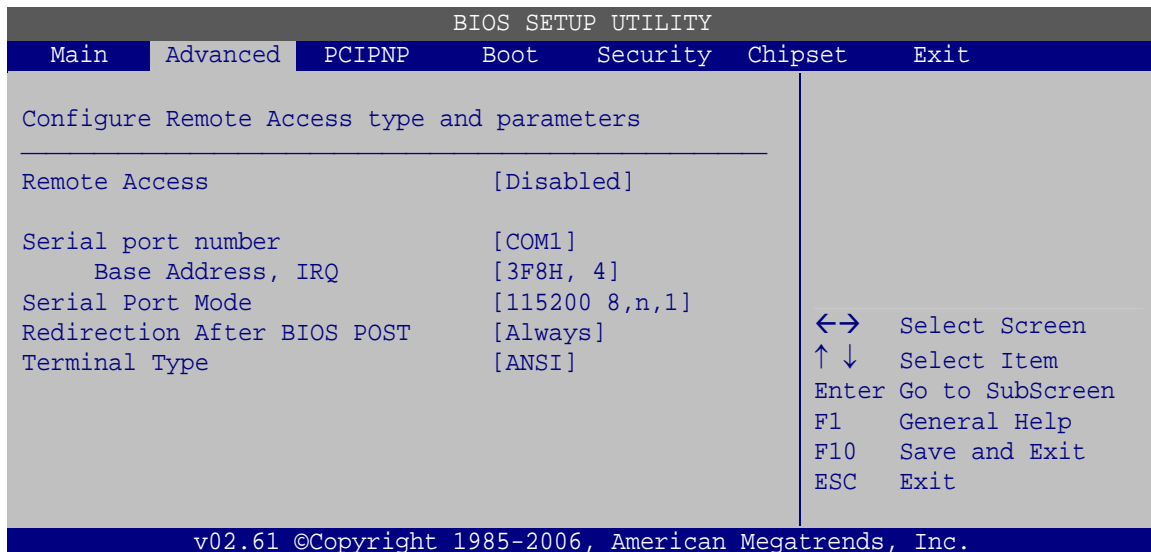
BIOS Menu 12: Remote Access Configuration

WSB-G41A CPU Card

→ Remote Access [Disabled]

Use the **Remote Access** option to enable or disable access to the remote functionalities of the system.

→ **Disabled** **DEFAULT** Remote access is disabled.

→ **Enabled** Remote access configuration options shown below appear:

Serial Port Number

Serial Port Mode

Flow Control

Redirection after BIOS POST

Terminal Type

These configuration options are discussed below.

→ Serial Port Number [COM1]

Use the **Serial Port Number** option to select the serial port used for remote access.

→ **COM1** **DEFAULT** System is remotely accessed through COM1

→ **COM2** System is remotely accessed through COM2

NOTE: Make sure the selected COM port is enabled through the Super I/O configuration menu.

→ Base Address, IRQ [2F8h,3]

The **Base Address, IRQ** option cannot be configured and only shows the interrupt address of the serial port listed above.

→ Serial Port Mode [115200 8,n,1]

Use the **Serial Port Mode** option to select baud rate through which the console redirection is made. The following configuration options are available

- 115200 8,n,1 **DEFAULT**

- 57600 8,n,1
- 38400 8,n,1
- 19200 8,n,1
- 09600 8,n,1

NOTE:

Identical baud rate setting must be set on the host (a management computer running a terminal software) and the slave

→ Redirection After BIOS POST [Always]

Use the **Redirection After BIOS POST** option to specify when console redirection should occur.

- | | | | |
|---|--------------------|----------------|--|
| → | Disabled | | The console is not redirected after POST |
| → | Boot Loader | | Redirection is active during POST and during Boot Loader |
| → | Always | DEFAULT | Redirection is always active (Some Oses may not work if set to Always) |

→ Terminal Type [ANSI]

Use the **Terminal Type** BIOS option to specify the remote terminal type.

- | | | | |
|---|----------------|----------------|-------------------------------------|
| → | ANSI | DEFAULT | The target terminal type is ANSI |
| → | VT100 | | The target terminal type is VT100 |
| → | VT-UTF8 | | The target terminal type is VT-UTF8 |

5.3.8 USB Configuration

Use the **USB Configuration** menu (**BIOS Menu 13**) to read USB configuration information and configure the USB settings.

WSB-G41A CPU Card

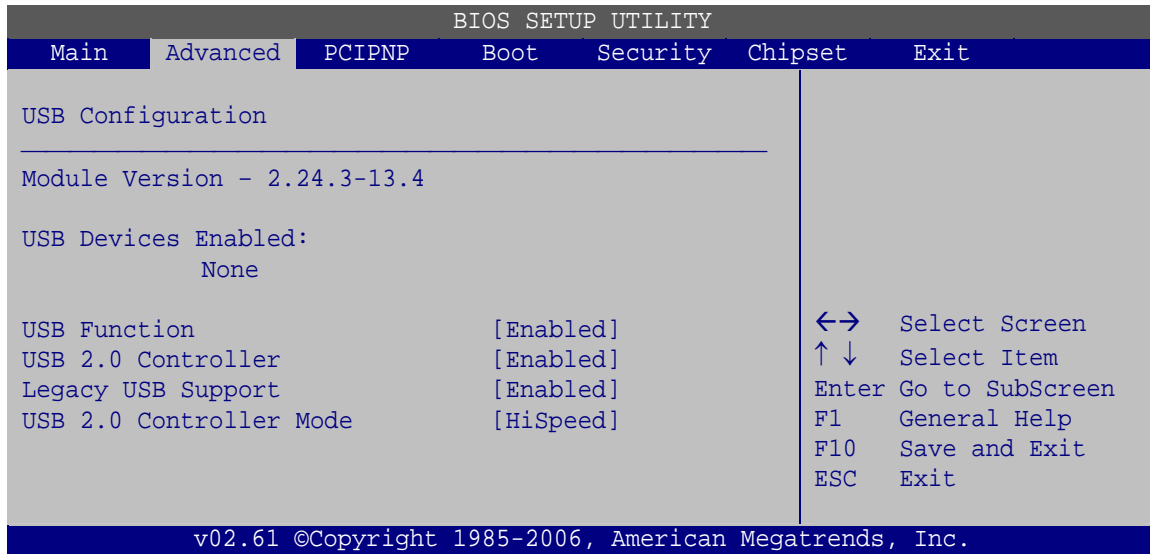

BIOS Menu 13: USB Configuration

→ USB Configuration

The **USB Configuration** field shows the system USB configuration. The items listed are:

- Module Version: x.xxxxx.xxxxx

→ USB Devices Enabled

The **USB Devices Enabled** field lists the USB devices that are enabled on the system

→ USB Function [Enabled]

Use the **USB Function** BIOS option to enable or disable USB function support.

- **Disabled** USB function support disabled
- **Enabled** **DEFAULT** USB function support enabled

→ USB 2.0 Controller [Enabled]

Use the **USB 2.0 Controller** BIOS option to enable or disable the USB 2.0 controller

- **Disabled** USB 2.0 controller disabled
- **Enabled** **DEFAULT** USB 2.0 controller enabled

➔ **Legacy USB Support [Enabled]**

Use the **Legacy USB Support** BIOS option to enable USB mouse and USB keyboard support.

Normally if this option is not enabled, any attached USB mouse or USB keyboard does not become available until a USB compatible operating system is fully booted with all USB drivers loaded. When this option is enabled, any attached USB mouse or USB keyboard can control the system even when there is no USB driver loaded onto the system.

- ➔ **Disabled** Legacy USB support disabled
- ➔ **Enabled** **DEFAULT** Legacy USB support enabled
- ➔ **Auto** Legacy USB support disabled if no USB devices are connected

➔ **USB2.0 Controller Mode [HiSpeed]**

Use the **USB2.0 Controller Mode** option to set the speed of the USB2.0 controller.

- ➔ **FullSpeed** The controller is capable of operating at 12 Mb/s
- ➔ **HiSpeed** **DEFAULT** The controller is capable of operating at 480 Mb/s

5.4 PCI/PnP

Use the **PCI/PnP** menu (**BIOS Menu 14**) to configure advanced PCI and PnP settings.



WARNING!

Setting wrong values for the BIOS selections in the PCIPnP BIOS menu may cause the system to malfunction.

WSB-G41A CPU Card

```

BIOS SETUP UTILITY
Main  Advanced  PCIPNP  Boot  Security  Chipset  Exit
-----
Advanced PCI/PnP Settings
-----
WARNING: Setting wrong values in below sections
         may cause system to malfunction
IRQ3           [Reserved]
IRQ4           [Reserved]
IRQ5           [Available]
IRQ7           [Available]
IRQ9           [Available]
IRQ10          [Available]
IRQ11          [Available]
IRQ14          [Available]
IRQ15          [Available]

DMA Channel 0  [Available]
DMA Channel 1  [Available]
DMA Channel 3  [Available]
DMA Channel 5  [Available]
DMA Channel 6  [Available]
DMA Channel 7  [Available]

Reserved Memory Size [Disabled]

<=> Select Screen
↑↓ Select Item
Enter Go to SubScreen
F1 General Help
F10 Save and Exit
ESC Exit

v02.61 ©Copyright 1985-2006, American Megatrends, Inc.

```

BIOS Menu 14: PCI/PnP Configuration

→ IRQ# [Available]

Use the **IRQ#** address to specify what IRQs can be assigned to a particular peripheral device.

- **Available** **DEFAULT** The specified IRQ is available to be used by PCI/PnP devices
- **Reserved** The specified IRQ is reserved for use by Legacy ISA devices

Available IRQ addresses are:

- IRQ3
- IRQ4
- IRQ5
- IRQ7

- IRQ9
- IRQ10
- IRQ 11
- IRQ 14
- IRQ 15

→ **DMA Channel# [Available]**

Use the **DMA Channel#** option to assign a specific DMA channel to a particular PCI/PnP device.

- | | | | |
|---|------------------|----------------|--|
| → | Available | DEFAULT | The specified DMA is available to be used by PCI/PnP devices |
| → | Reserved | | The specified DMA is reserved for use by Legacy ISA devices |

Available DMA Channels are:

- DM Channel 0
- DM Channel 1
- DM Channel 3
- DM Channel 5
- DM Channel 6
- DM Channel 7

→ **Reserved Memory Size [Disabled]**

Use the **Reserved Memory Size** BIOS option to specify the amount of memory that should be reserved for legacy ISA devices.

- | | | | |
|---|-----------------|----------------|---|
| → | Disabled | DEFAULT | No memory block reserved for legacy ISA devices |
| → | 16K | | 16 KB reserved for legacy ISA devices |
| → | 32K | | 32 KB reserved for legacy ISA devices |
| → | 64K | | 54 KB reserved for legacy ISA devices |

WSB-G41A CPU Card

5.5 Boot

Use the **Boot** menu (**BIOS Menu 15**) to configure system boot options.

```

BIOS SETUP UTILITY
Main  Advanced  PCIPNP  Boot  Security  Chipset  Exit
-----
Boot Settings
-----
> Boot Settings Configuration

> Boot Device Priority
> Hard Disk Drives
> CD/DVD Drives
> Removable Drives

<=>  Select Screen
↑↓   Select Item
Enter Go to SubScreen
F1   General Help
F10  Save and Exit
ESC  Exit

v02.61 ©Copyright 1985-2006, American Megatrends, Inc.

```

BIOS Menu 15: Boot

5.5.1 Boot Settings Configuration

Use the **Boot Settings Configuration** menu (**BIOS Menu 16**) to configure advanced system boot options.

```

BIOS SETUP UTILITY
Main  Advanced  PCIPNP  Boot  Security  Chipset  Exit
-----
Boot Settings Configuration
-----
Quick Boot                [Enabled]
Quiet Boot                [Enabled]
AddOn ROM Display Mode   [Force BIOS]
Bootup Num-Lock          [On]
Boot From LAN Support     [Disabled]

<=>  Select Screen
↑↓   Select Item
Enter Go to SubScreen
F1   General Help
F10  Save and Exit
ESC  Exit

v02.61 ©Copyright 1985-2006, American Megatrends, Inc.

```

BIOS Menu 16: Boot Settings Configuration

→ Quick Boot [Enabled]

Use the **Quick Boot** BIOS option to make the computer speed up the boot process.

- **Disabled** No POST procedures are skipped
- **Enabled** **DEFAULT** Some POST procedures are skipped to decrease the system boot time

→ Quiet Boot [Disabled]

Use the **Quiet Boot** BIOS option to select the screen display when the system boots.

- **Disabled** **DEFAULT** Normal POST messages displayed
- **Enabled** OEM Logo displayed instead of POST messages

→ AddOn ROM Display Mode [Force BIOS]

Use the **AddOn ROM Display Mode** option to allow add-on ROM (read-only memory) messages to be displayed.

- **Force BIOS** **DEFAULT** The system forces third party BIOS to display during system boot.
- **Keep Current** The system displays normal information during system boot.

→ Bootup Num-Lock [On]

Use the **Bootup Num-Lock** BIOS option to specify if the number lock setting must be modified during boot up.

- **Off** Does not enable the keyboard Number Lock automatically. To use the 10-keys on the keyboard, press the Number Lock key located on the upper left-hand corner of the 10-key pad. The Number Lock LED on the keyboard lights up when the Number Lock is engaged.

WSB-G41A CPU Card

- ➔ **On** **DEFAULT** Allows the Number Lock on the keyboard to be enabled automatically when the computer system boots up. This allows the immediate use of the 10-key numeric keypad located on the right side of the keyboard. To confirm this, the Number Lock LED light on the keyboard is lit.

➔ **Boot From LAN Support [Disabled]**

Use the **BOOT From LAN Support** option to enable the system to be booted from a remote system.

- ➔ **Disabled** **DEFAULT** Cannot be booted from a remote system through the LAN
- ➔ **Enabled** **DEFAULT** Can be booted from a remote system through the LAN

5.5.2 Boot Device Priority

Use the **Boot Device Priority** menu (**BIOS Menu 17**) to specify the boot sequence from the available devices. The drive sequence also depends on the boot sequence in the individual device section.

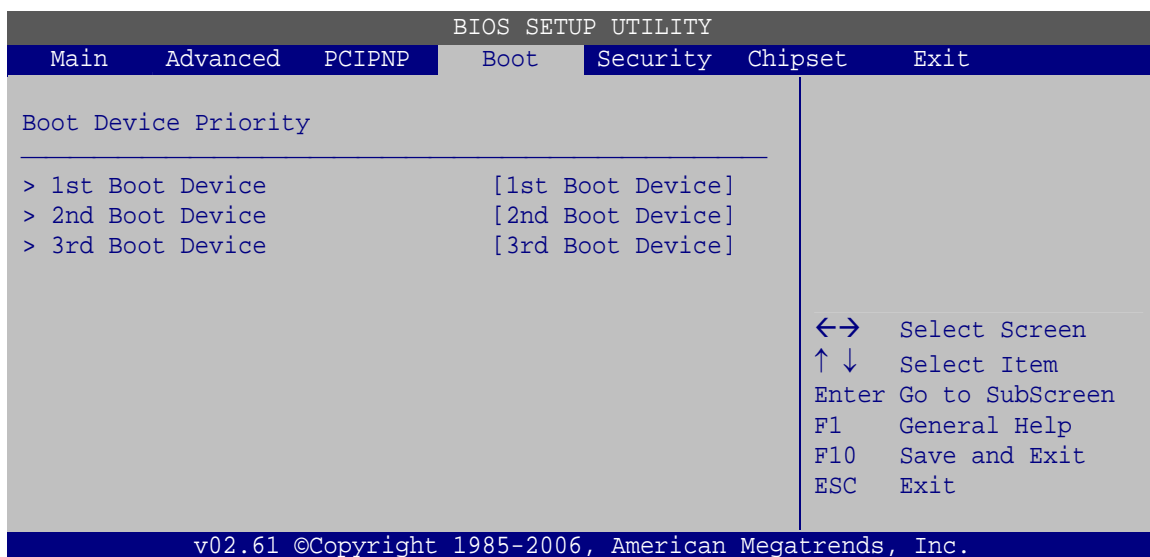

BIOS Menu 17: Boot Device Priority Settings

5.5.3 Hard Disk Drives

Use the **Hard Disk Drives** menu to specify the boot sequence of the available HDDs. Only installed hard drives are shown.

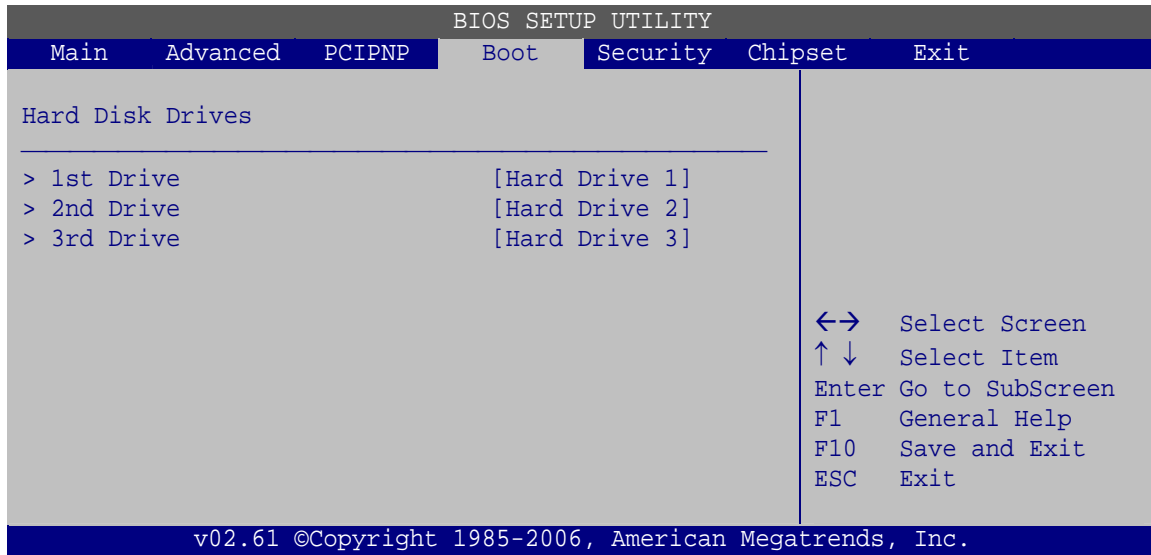

BIOS Menu 18: Hard Disk Drives

5.5.4 Removable Drives

Use the **Removable Drives** menu (**BIOS Menu 19**) to specify the boot sequence of the removable drives. Only connected drives are shown.

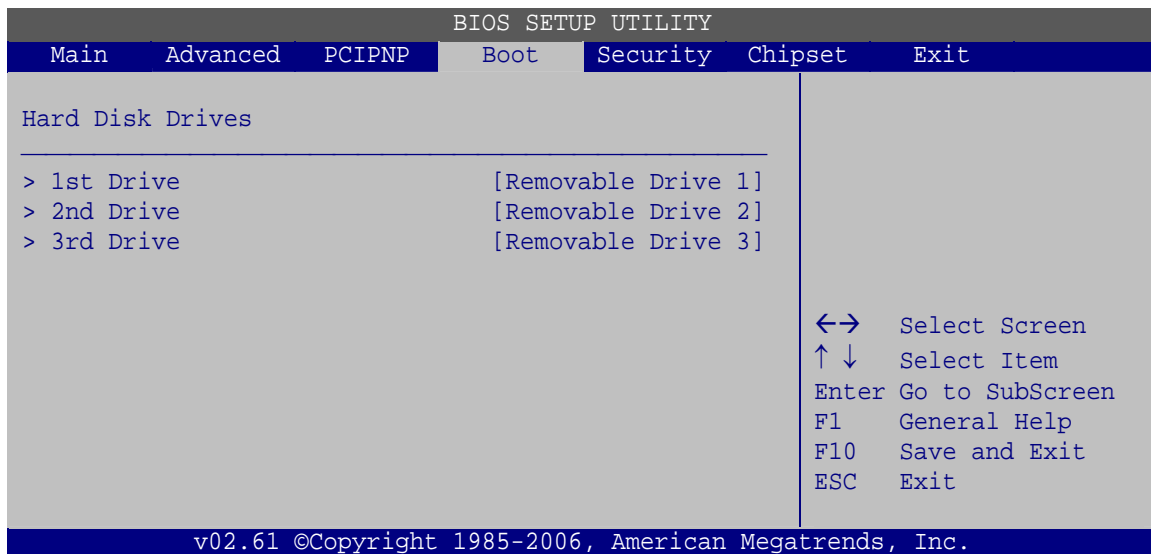

BIOS Menu 19: Removable Drives

WSB-G41A CPU Card

5.5.5 CD/DVD Drives

Use the **CD/DVD Drives** menu to specify the boot sequence of the available CD/DVD drives.

```

BIOS SETUP UTILITY
Main  Advanced  PCIPNP  Boot  Security  Chipset  Exit
-----
Hard Disk Drives
-----
> 1st Drive          [CD/DVD 1]
> 2nd Drive          [CD/DVD 2]
> 3rd Drive          [CD/DVD 3]

<=>  Select Screen
↑↓   Select Item
Enter Go to SubScreen
F1   General Help
F10  Save and Exit
ESC  Exit

v02.61 ©Copyright 1985-2006, American Megatrends, Inc.

```

BIOS Menu 20: CD/DVD Drives

5.6 Security

Use the **Security** menu (**BIOS Menu 21**) to set system and user passwords.

```

BIOS SETUP UTILITY
Main  Advanced  PCIPNP  Boot  Security  Chipset  Exit
-----
Security Settings
-----
Supervisor Password :Not Installed
User Password       :Not Installed

Change Supervisor Password
Change User Password

<=>  Select Screen
↑↓   Select Item
Enter Go to SubScreen
F1   General Help
F10  Save and Exit
ESC  Exit

v02.61 ©Copyright 1985-2006, American Megatrends, Inc.

```

BIOS Menu 21: Security

→ **Change Supervisor Password**

Use the **Change Supervisor Password** to set or change a supervisor password. The default for this option is **Not Installed**. If a supervisor password must be installed, select this field and enter the password. After the password has been added, **Install** appears next to **Change Supervisor Password**.

→ **Change User Password**

Use the **Change User Password** to set or change a user password. The default for this option is **Not Installed**. If a user password must be installed, select this field and enter the password. After the password has been added, **Install** appears next to **Change User Password**.

→ **Clear User Password**

Use the **Clear User Password** to clear a user's password. The default for this option is **Not Installed**. If a user password must be cleared, use this option.

→ **Boot Sector Virus Protection [Disabled]**

Use the **Boot Sector Virus Protection** to enable or disable boot sector protection.

- **Disabled** **DEFAULT** Disables the boot sector virus protection
- **Enabled** Enables the boot sector virus protection

5.7 Chipset

Use the **Chipset** menu (**BIOS Menu 22**) to access the Northbridge and Southbridge configuration menus



WARNING!

Setting the wrong values for the Chipset BIOS selections in the Chipset BIOS menu may cause the system to malfunction.

WSB-G41A CPU Card

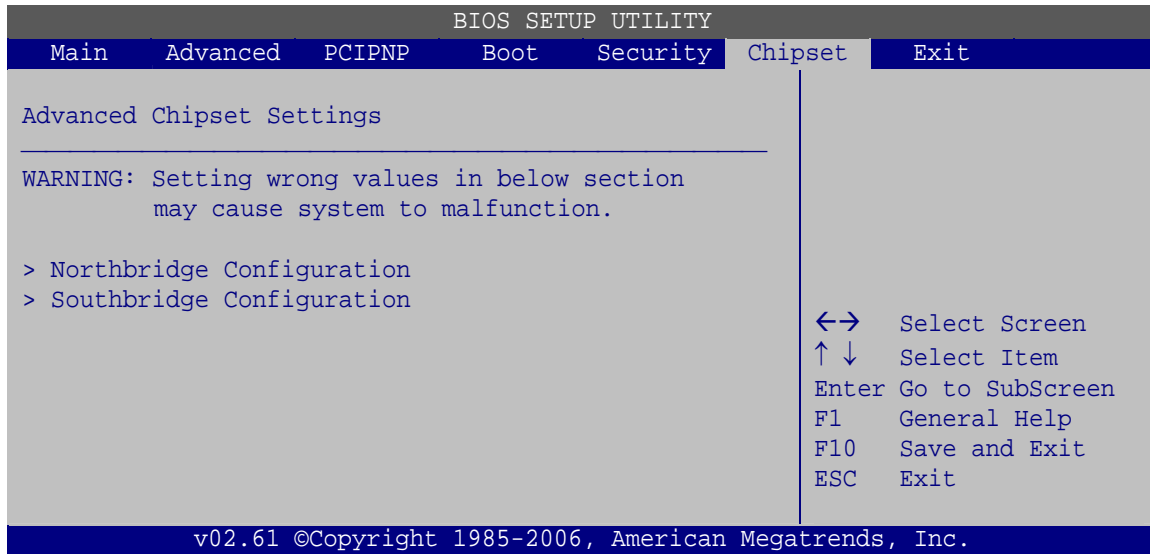

BIOS Menu 22: Chipset

5.7.1 Northbridge Configuration

Use the **Northbridge Chipset Configuration** menu (**BIOS Menu 23**) to configure the Northbridge chipset.

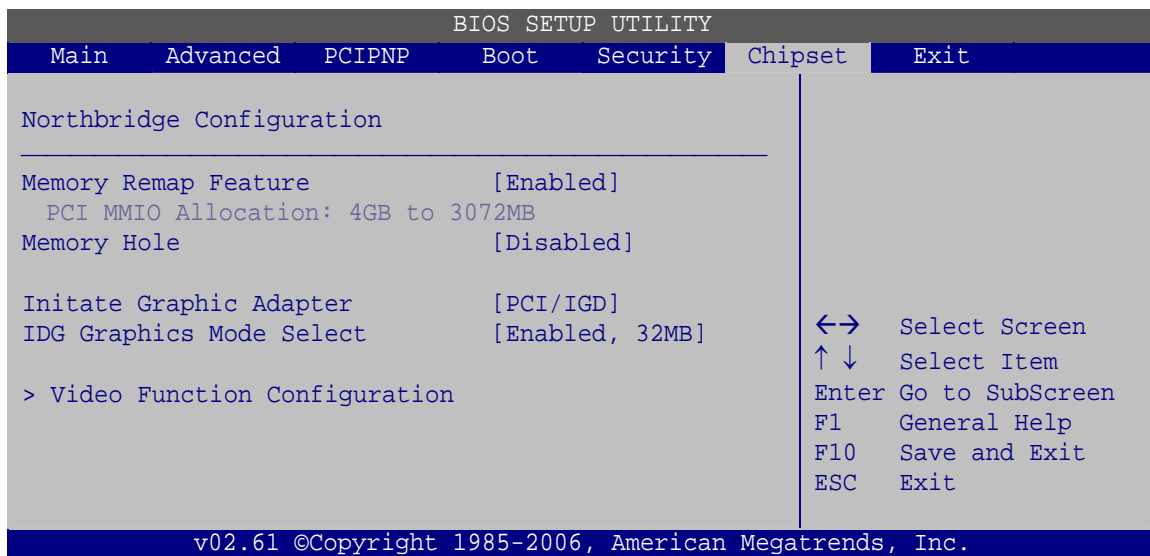

BIOS Menu 23:Northbridge Chipset Configuration

➔ Memory Remap Feature [Enabled]

Use the **Memory Remap Feature** option to allow the overlapped PCI memory above the total physical memory to be remapped.

- **Enabled** **DEFAULT** Overlapped PCI memory can be remapped
- **Disabled** Overlapped PCI memory cannot be remapped

→ **Memory Hole [Disabled]**

Use the **Memory Hole** option to reserve memory space between 15 MB and 16 MB for ISA expansion cards that require a specified area of memory to work properly. If an older ISA expansion card is used, please refer to the documentation that came with the card to see if it is necessary to reserve the space.

- **Disabled** **DEFAULT** Memory is not reserved for ISA expansion cards
- **15 MB–16 MB** Between 15 MB and 16 MB of memory is reserved for ISA expansion cards

→ **Initiate Graphic Adapter**

Use the **Initiate Graphic Adapter** option to select the graphics controller used as the primary boot device. Select either an integrated graphics controller (IGD) or a combination of PCI graphics controller, a PCI express (PEG) controller or an IGD. Configuration options are listed below:

- IGD
- **PCI/IGD** **DEFAULT**

→ **IGD Graphics Mode Select [Enable, 32 MB]**

Use the **IGD Graphic Mode Select** option to specify the amount of system memory that can be used by the internal graphics device.

- **Disable**
- **Enable, 32 MB** **DEFAULT** 32 MB of memory used by internal graphics device
- **Enable, 64 MB** 64 MB of memory used by internal graphics device
- **Enable, 128 MB** 128 MB of memory used by internal graphics device

WSB-G41A CPU Card

5.7.1.1 Video Function Configuration

Use the **Video Function Configuration** menu to configure video settings.

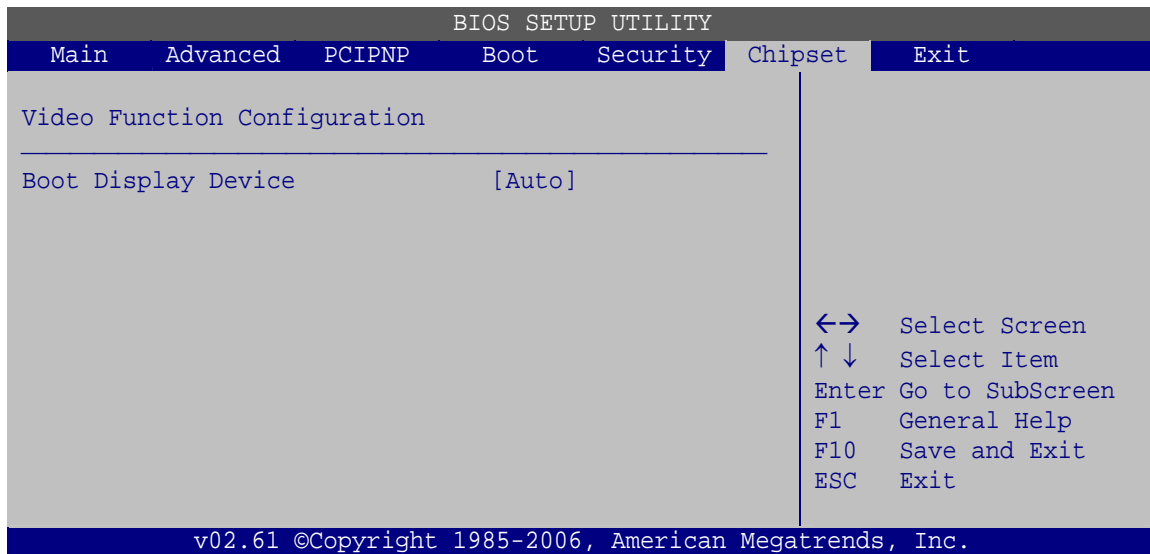

BIOS Menu 24:Northbridge Chipset Configuration

→ Boot Display Device [Auto]

Specifies the display device to use when the system is first turned on.

- Auto **Default**
- CRT
- DVI

5.7.2 Southbridge Configuration

Use the **Southbridge Configuration** menu (**BIOS Menu 25**) to configure the Southbridge chipset.

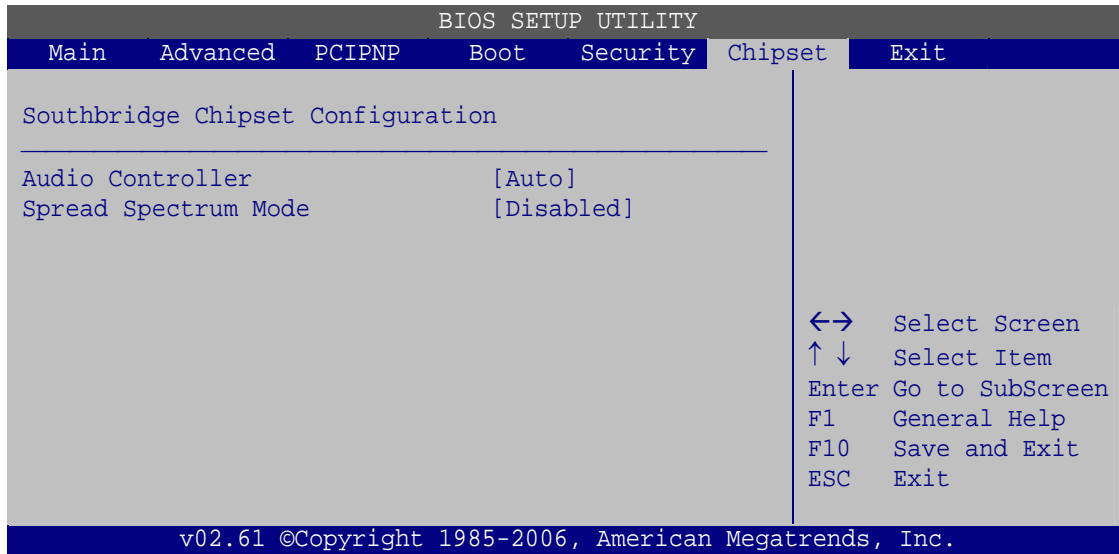

BIOS Menu 25: Southbridge Chipset Configuration

→ Audio Controller [Enabled]

Use the **Audio Controller** option to enable the audio controller.

- **Disabled** Audio controller disabled
- **Auto** (Default) Audio controller automatically detected and enabled

→ Spread Spectrum [Disabled]

Use the **Spread Spectrum** option to reduce the EMI. Excess EMI is generated when the system clock generator pulses have extreme values. Spreading the pulse spectrum modulates changes in the extreme values from spikes to flat curves, thus reducing the EMI. This benefit may in some cases be outweighed by problems with timing-critical devices, such as a clock-sensitive SCSI device.

- **Disabled** **DEFAULT** EMI not reduced
- **Enabled** EMI reduced

5.8 Exit

Use the **Exit** menu (**BIOS Menu 26**) to load default BIOS values, optimal failsafe values and to save configuration changes.

WSB-G41A CPU Card

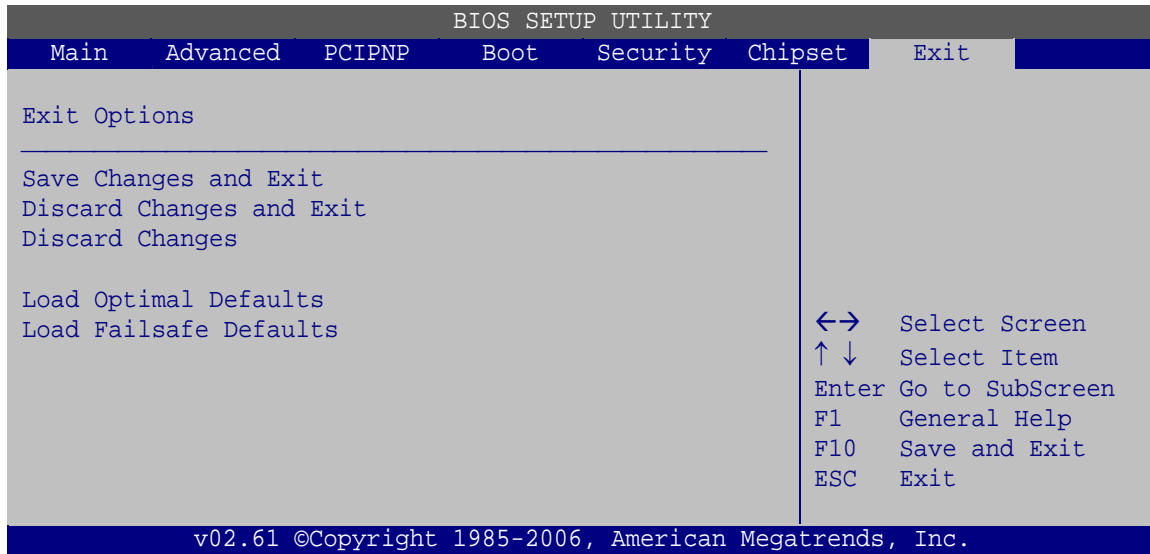

BIOS Menu 26: Exit

→ Save Changes and Exit

Use the **Save Changes and Exit** option to save the changes made to the BIOS options and to exit the BIOS configuration setup program.

→ Discard Changes and Exit

Use the **Discard Changes and Exit** option to exit the BIOS configuration setup program without saving the changes made to the system.

→ Discard Changes

Use the **Discard Changes** option to discard the changes and remain in the BIOS configuration setup program.

→ Load Optimal Defaults

Use the **Load Optimal Defaults** option to load the optimal default values for each of the parameters on the Setup menus. **F9 key can be used for this operation.**

→ Load Failsafe Defaults

Use the **Load Failsafe Defaults** option to load failsafe default values for each of the parameters on the Setup menus. **F8 key can be used for this operation.**

Appendix

A

BIOS Options

Below is a list of BIOS configuration options in the BIOS chapter.

➔	System Overview	56
➔	System Time [xx:xx:xx]	57
➔	System Date [xx/xx/xx]	57
➔	ATA/IDE Configurations [Compatible]	59
➔	Configure SATA as [IDE]	60
➔	Configure SATA Channels [Behind PATA]	60
➔	IDE Master and IDE Slave	60
➔	Auto-Detected Drive Parameters	61
➔	Type [Auto]	62
➔	LBA/Large Mode [Auto]	62
➔	Block (Multi Sector Transfer) [Auto]	63
➔	PIO Mode [Auto]	63
➔	DMA Mode [Auto]	64
➔	S.M.A.R.T [Auto]	65
➔	32Bit Data Transfer [Enabled]	65
➔	Floppy A/B	66
➔	Parallel Port Address [Disabled]	67
➔	Parallel Port Mode [Normal]	67
➔	Parallel Port IRQ [IRQ7]	68
➔	Serial Port1 Address [3F8/IRQ4]	68
➔	Serial Port1 Mode [Normal]	69
➔	Serial Port2 Address [2F8/IRQ3]	69
➔	Serial Port2 Mode [Normal]	69
➔	Mode Setting [Full On Mode]	70
➔	Temp. Limit of OFF [000]	71
➔	Temp. Limit of Start [020]	71
➔	Start PWM [070]	71
➔	Slope PWM [1 PWM]	71
➔	CPU Fan PWM Control [070]	72
➔	Hardware Health Monitoring	72
➔	Suspend Mode [S1(POS)]	74
➔	Restore on AC Power Loss [Last State]	74
➔	Resume on Keyboard/Mouse [Disabled]	75

WSB-G41A CPU Card

➔ Resume on Ring [Disabled]	75
➔ Resume on PCI-Express WAKE# [Enabled].....	75
➔ Resume On RTC Alarm [Disabled].....	76
➔ Remote Access [Disabled].....	77
➔ Serial Port Number [COM1].....	77
➔ Base Address, IRQ [2F8h,3].....	77
➔ Serial Port Mode [115200 8,n,1].....	77
➔ Redirection After BIOS POST [Always]	78
➔ Terminal Type [ANSI].....	78
➔ USB Configuration.....	79
➔ USB Devices Enabled.....	79
➔ USB Function [Enabled].....	79
➔ USB 2.0 Controller [Enabled].....	79
➔ Legacy USB Support [Enabled].....	80
➔ USB2.0 Controller Mode [HiSpeed].....	80
➔ IRQ# [Available]	81
➔ DMA Channel# [Available]	82
➔ Reserved Memory Size [Disabled]	82
➔ Quick Boot [Enabled]	84
➔ Quiet Boot [Disabled]	84
➔ AddOn ROM Display Mode [Force BIOS]	84
➔ Bootup Num-Lock [On]	84
➔ Boot From LAN Support [Disabled]	85
➔ Change Supervisor Password.....	88
➔ Change User Password.....	88
➔ Clear User Password.....	88
➔ Boot Sector Virus Protection [Disabled]	88
➔ Memory Remap Feature [Enabled].....	89
➔ Memory Hole [Disabled].....	90
➔ Initiate Graphic Adapter	90
➔ IGD Graphics Mode Select [Enable, 32 MB]	90
➔ Boot Display Device [Auto].....	91
➔ Audio Controller [Enabled]	92
➔ Spread Spectrum [Disabled].....	92
➔ Save Changes and Exit	93



➔ Discard Changes and Exit.....	93
➔ Discard Changes.....	93
➔ Load Optimal Defaults.....	93
➔ Load Failsafe Defaults.....	93

Appendix

B

Terminology

AC '97	Audio Codec 97 (AC'97) refers to a codec standard developed by Intel® in 1997.
ACPI	Advanced Configuration and Power Interface (ACPI) is an OS-directed configuration, power management, and thermal management interface.
AHCI	Advanced Host Controller Interface (AHCI) is a SATA Host controller register-level interface.
ATA	The Advanced Technology Attachment (ATA) interface connects storage devices including hard disks and CD-ROM drives to a computer.
ARMD	An ATAPI Removable Media Device (ARMD) is any ATAPI device that supports removable media, besides CD and DVD drives.
ASKIR	Amplitude Shift Keyed Infrared (ASKIR) is a form of modulation that represents a digital signal by varying the amplitude (“volume”) of the signal. A low amplitude signal represents a binary 0, while a high amplitude signal represents a binary 1.
BIOS	The Basic Input/Output System (BIOS) is firmware that is first run when the computer is turned on and can be configured by the end user
CODEC	The Compressor-Decompressor (CODEC) encodes and decodes digital audio data on the system.
CMOS	Complimentary metal-oxide-conductor is an integrated circuit used in chips like static RAM and microprocessors.
COM	COM refers to serial ports. Serial ports offer serial communication to expansion devices. The serial port on a personal computer is usually a male DB-9 connector.
DAC	The Digital-to-Analog Converter (DAC) converts digital signals to analog signals.
DDR	Double Data Rate refers to a data bus transferring data on both the rising and falling edges of the clock signal.
DMA	Direct Memory Access (DMA) enables some peripheral devices to bypass the system processor and communicate directly with the system memory.

WSB-G41A CPU Card

DIMM	Dual Inline Memory Modules are a type of RAM that offer a 64-bit data bus and have separate electrical contacts on each side of the module.
DIO	The digital inputs and digital outputs are general control signals that control the on/off circuit of external devices or TTL devices. Data can be read or written to the selected address to enable the DIO functions.
EHCI	The Enhanced Host Controller Interface (EHCI) specification is a register-level interface description for USB 2.0 Host Controllers.
EIDE	Enhanced IDE (EIDE) is a newer IDE interface standard that has data transfer rates between 4.0 MBps and 16.6 MBps.
EIST	Enhanced Intel® SpeedStep Technology (EIST) allows users to modify the power consumption levels and processor performance through application software. The application software changes the bus-to-core frequency ratio and the processor core voltage.
FSB	The Front Side Bus (FSB) is the bi-directional communication channel between the processor and the Northbridge chipset.
GbE	Gigabit Ethernet (GbE) is an Ethernet version that transfers data at 1.0 Gbps and complies with the IEEE 802.3-2005 standard.
GPIO	General purpose input
HDD	Hard disk drive (HDD) is a type of magnetic, non-volatile computer storage device that stores digitally encoded data.
ICH	The Input/Output Control Hub (ICH) is an Intel® Southbridge chipset.
IrDA	Infrared Data Association (IrDA) specify infrared data transmission protocols used to enable electronic devices to wirelessly communicate with each other.
L1 Cache	The Level 1 Cache (L1 Cache) is a small memory cache built into the system processor.
L2 Cache	The Level 2 Cache (L2 Cache) is an external processor memory cache.
LCD	Liquid crystal display (LCD) is a flat, low-power display device that consists of two polarizing plates with a liquid crystal panel in between.

LVDS	Low-voltage differential signaling (LVDS) is a dual-wire, high-speed differential electrical signaling system commonly used to connect LCD displays to a computer.
POST	The Power-on Self Test (POST) is the pre-boot actions the system performs when the system is turned-on.
RAM	Random Access Memory (RAM) is volatile memory that loses data when power is lost. RAM has very fast data transfer rates compared to other storage like hard drives.
SATA	Serial ATA (SATA) is a serial communications bus designed for data transfers between storage devices and the computer chipsets. The SATA bus has transfer speeds up to 1.5 Gbps and the SATA II bus has data transfer speeds of up to 3.0 Gbps.
S.M.A.R.T	Self Monitoring Analysis and Reporting Technology (S.M.A.R.T) refers to automatic status checking technology implemented on hard disk drives.
UART	Universal Asynchronous Receiver-transmitter (UART) is responsible for asynchronous communications on the system and manages the system's serial communication (COM) ports.
UHCI	The Universal Host Controller Interface (UHCI) specification is a register-level interface description for USB 1.1 Host Controllers.
USB	The Universal Serial Bus (USB) is an external bus standard for interfacing devices. USB 1.1 supports 12Mbps data transfer rates and USB 2.0 supports 480Mbps data transfer rates.
VGA	The Video Graphics Array (VGA) is a graphics display system developed by IBM.

Appendix

C

One Key Recovery

C.1 One Key Recovery Introduction

The IEI one key recovery is an easy-to-use front end for the Norton Ghost system backup and recovery tool. The one key recovery provides quick and easy shortcuts for creating a backup and reverting to that backup or for reverting to the factory default settings.

To create the system backup the main storage device must be split into two partitions (three partitions for Linux). The first partition will be for the operating system, while the second partition will be invisible to the operating system and contain the backup made by the one key recovery software.

C.1.1 System Requirement

The partition created for recovery images must be big enough to contain both the factory default image and the user backup image. The size must be calculated before creating the partitions. Please take the following table as a reference when calculating the size of the partition.

	OS	OS Image after Ghost	Compression Ratio
Windows® 7	7 GB	5 GB	70%
Windows® XPE	776 MB	560 MB	70%
Windows® CE 6.0	36 MB	28 MB	77%



NOTE:

Specialized tools are required to change the partition size if the operating system is already installed.

C.1.2 Supported Operating System

The recovery CD is compatible with both Microsoft Windows and Linux operating system (OS). The supported OS versions are listed below.

- Microsoft Windows
 - Windows XP (Service Pack 2 or 3 required)
 - Windows Vista

WSB-G41A CPU Card

- Windows 7
- Windows CE 5.0
- Windows CE 6.0
- Windows XP Embedded
- Linux
 - Fedora Core 12 (Constantine)
 - Fedora Core 11 (Leonidas)
 - Fedora Core 10 (Cambridge)
 - Fedora Core 8 (Werewolf)
 - Fedora Core 7 (Moonshine)
 - RedHat RHEL-5.4
 - RedHat 9 (Ghirke)
 - Ubuntu 8.10 (Intrepid)
 - Ubuntu 7.10 (Gutsy)
 - Ubuntu 6.10 (Edgy)
 - Debian 5.0 (Lenny)
 - Debian 4.0 (Etch)
 - SuSe 11.2
 - SuSe 11.3



NOTE:

Installing unsupported OS versions may cause the recovery tool to fail.

**NOTE:**

The recovery CD can only be used with IEI products. The software will fail to run and a warning message will appear when used on non-IEI hardware.

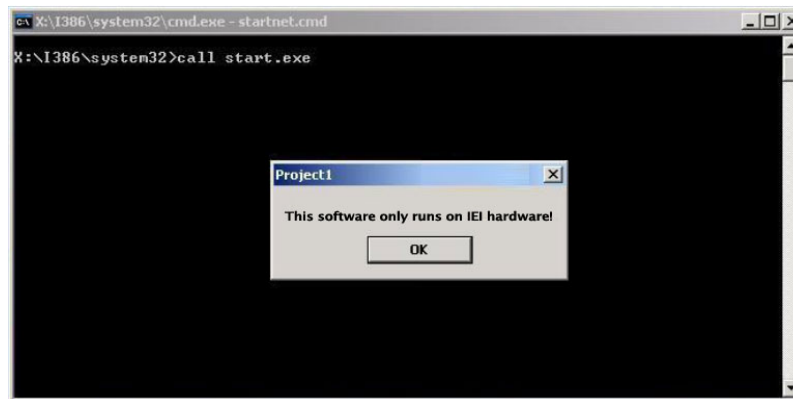

C.2 Setup Procedure for Windows

Prior to using the recovery tool to backup or restore system, a few setup procedures are required.

- Step 1:** Hardware and BIOS setup
- Step 2:** Create partitions
- Step 3:** Install operating system, drivers and system applications.
- Step 4:** Build-up recovery partition
- Step 5:** Create factory default image

The detailed descriptions are described in the following sections.

**NOTE:**

The setup procedures described below are for Microsoft Windows operating system users. For Linux system, most setup procedures are the same with Microsoft Windows except for several steps which is described in **Section C.3**.

C.2.1 Hardware and BIOS Setup

- Step 1:** Make sure the system is powered off and unplugged.
- Step 2:** Install a hard driver or SSD in the WSB-G41A. An unformatted and unpartitioned disk is recommended.
- Step 3:** Connect an optical disk drive to the WSB-G41A and insert the recovery CD.
- Step 4:** Turn on the system.
- Step 5:** Press the <DELETE> key as soon as the system is turned on to enter the BIOS.
- Step 6:** Select the connected optical disk drive as the 1st boot device. (**Boot → Boot Device Priority → 1st Boot Device**).
- Step 7:** Save changes and restart the computer. Continue to the next section for instructions on partitioning the internal storage.

C.2.2 Create Partitions

- Step 1:** Put the recovery CD in the optical drive.
- Step 2:** Turn on the system.
- Step 3:** When prompted, press any key to boot from the recovery CD. It will take a while to launch the recovery tool. Please be patient.
- Step 4:** The recovery tool setup menu is shown as below.

```

C:\X:\I386\system32\cmd.exe
1.Ghost Execution
2.System Configuration For Windows
3.System Configuration For Linux
4.Exit
5.CMD
Type the number to print text._
  
```

Figure C-1: Recovery Tool Setup Menu

Step 5: Press <5> then <Enter>.

```

C:\X:\I386\system32\cmd.exe
1.Ghost Execution
2.System Configuration For Windows
3.System Configuration For Linux
4.Exit
5.CMD
Type the number to print text.5
  
```

Figure C-2: Command Mode

Step 6: The command prompt window appears. Type the following commands (marked in red) to create two partitions. One is for the OS installation; the other is for saving recovery files and images which will be an invisible partition.
(Press <Enter> after entering each line below)

```

system32>diskpart
DISKPART>list vol
DISKPART>sel disk 0
DISKPART>create part pri size= ____
DISKPART>assign letter=N
DISKPART>create part pri size= ____
DISKPART>assign letter=F
DISKPART>exit
system32>format N: /fs:ntfs /q /y
system32>format F: /fs:ntfs /q /v:Recovery /y
system32>exit
  
```



```

X:\I386\SYSTEM32\CMD.EXE
X:\I386\SYSTEM32>diskpart → Starts the Microsoft disk partitioning tool.

Microsoft DiskPart version 5.2.3790.1830
Copyright (C) 1999-2001 Microsoft Corporation.
On computer: MININT-JUC

DISKPART> list vol → Show partition information

   Volume ###  Ltr  Label          Fs      Type          Size      Status       Info
   -----  -  -  -  -  -  -  -  -
Volume 0             X  CD_ROM        CDFS    DUD-ROM       405 MB    Healthy      Boot
Volume 1             D                   FAT32    Removeable   3854 MB    Healthy

DISKPART> sel disk 0 → Select a disk
Disk 0 is now the selected disk.

DISKPART> create part pri size=2000 → Create partition 1 and assign a size.
                                     This partition is for OS installation.
DiskPart succeeded in creating the specified partition.

DISKPART> assign letter=N → Assign partition 1 a code name (N).
DiskPart successfully assigned the drive letter or mount point.

DISKPART> create part pri size=1800 → Create partition 2 and assign a size.
                                     This partition is for recovery images.
DiskPart succeeded in creating the specified partition.

DISKPART> assign letter=F → Assign partition 2 a code name (F).
DiskPart successfully assigned the drive letter or mount point.

DISKPART> exit → Exit diskpart

X:\I386\SYSTEM32>format n: /fs:ntfs /q /y → Format partition 1 (N) as NTFS format.
The type of the file system is RAW.
The new file system is NTFS.
QuickFormatting 2000M
Creating file system structures.
Format complete.
 2048254 KB total disk space.
 2035620 KB are available.

X:\I386\SYSTEM32>format f: /fs:ntfs /q /v:Recovery /y
The type of the file system is RAW.
The new file system is NTFS.
QuickFormatting 1804M
Creating file system structures.
Format complete.
 1847474 KB total disk space.
 1835860 KB are available.

X:\I386\SYSTEM32>exit → Exit Windows PE
  
```

Figure C-3: Partition Creation Commands

**NOTE:**

Use the following commands to check if the partitions were created successfully.

```
X:\I386\SYSTEM32>diskpart
Microsoft DiskPart version 5.2.3790.1830
Copyright (C) 1999-2001 Microsoft Corporation.
On computer: MININT-JUC

DISKPART> sel disk 0
Disk 0 is now the selected disk.

DISKPART> list part

   Partition ###   Type              Size              Offset
-----
   Partition 1     Primary            2000 MB           32 KB
   Partition 2     Primary            1804 MB          2000 MB

DISKPART> exit
```

Step 7: Press any key to exit the recovery tool and automatically reboot the system.

Please continue to the following procedure: Build-up Recovery Partition.

C.2.3 Install Operating System, Drivers and Applications

Install the operating system onto the unlabelled partition. The partition labeled as "Recovery" is for use by the system recovery tool and should not be used for installing the operating system or any applications.

**NOTE:**

The operating system installation program may offer to reformat the chosen partition. DO NOT format the partition again. The partition has already been formatted and is ready for installing the new operating system.

To install the operating system, insert the operating system installation CD into the optical drive. Restart the computer and follow the installation instructions.

C.2.4 Build-up Recovery Partition

Step 1: Put the recover CD in the optical drive.

WSB-G41A CPU Card

- Step 2:** Start the system.
- Step 3:** Press any key to boot from the recovery CD. It will take a while to launch the recovery tool. Please be patient.
- Step 4:** When the recovery tool setup menu appears, press <2> then <Enter>.

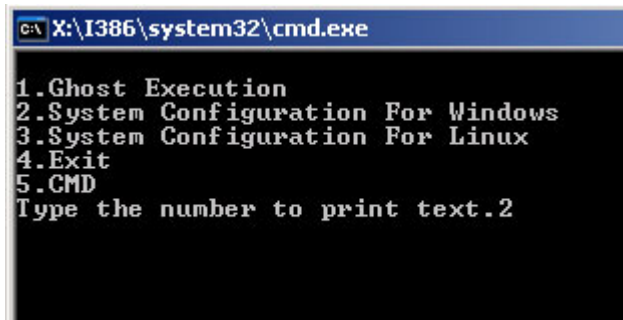

Figure C-4: System Configuration for Windows

- Step 5:** The Symantec Ghost window appears and starts configuring the system to build-up a recovery partition. In this process, the partition which is created for recovery files in **Section C.2.2** is hidden and the recovery tool is saved in this partition.

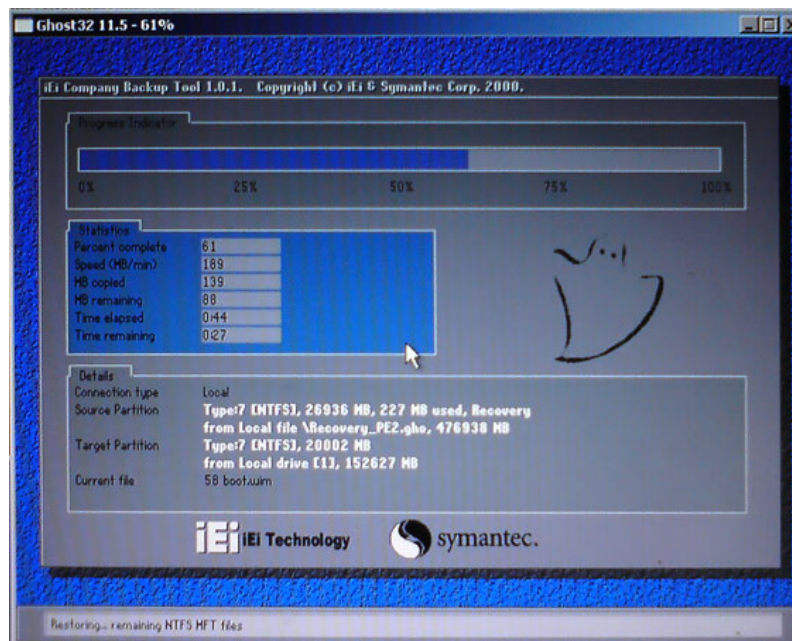
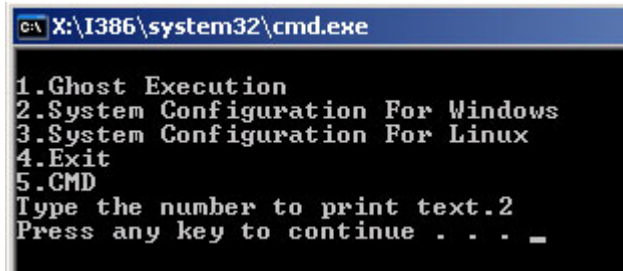

Figure C-5: Build-up Recovery Partition

Step 6: After completing the system configuration, press any key in the following window to reboot the system.



```

c:\X:\I386\system32\cmd.exe
1.Ghost Execution
2.System Configuration For Windows
3.System Configuration For Linux
4.Exit
5.CMD
Type the number to print text.2
Press any key to continue . . . _
  
```

Figure C-6: Press any key to continue

Step 7: Eject the recovery CD.

C.2.5 Create Factory Default Image



NOTE:

Before creating the factory default image, please configure the system to a factory default environment, including driver and application installations.

To create a factory default image, please follow the steps below.

Step 1: Turn on the system. When the following screen displays (**Figure C-7**), press the <F3> key to access the recovery tool. The message will display for 10 seconds, please press F3 before the system boots into the operating system.

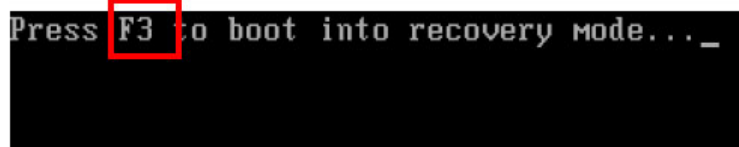

```

Press F3 to boot into recovery mode... _
  
```

Figure C-7: Press F3 to Boot into Recovery Mode

Step 2: The recovery tool menu appears. Type <4> and press <Enter>. (**Figure C-8**)

WSB-G41A CPU Card

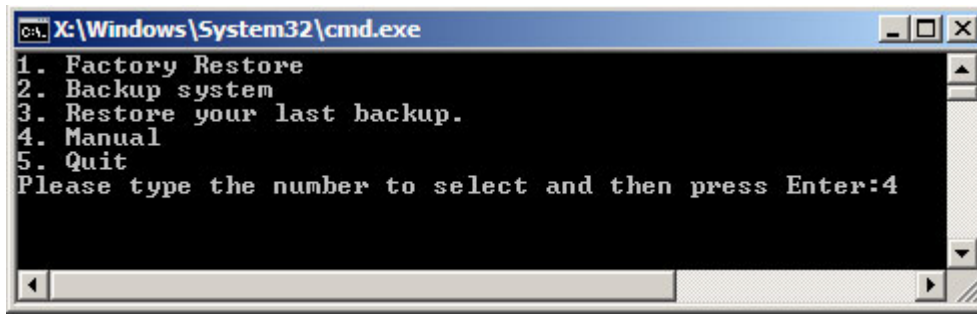

Figure C-8: Recovery Tool Menu

Step 3: The About Symantec Ghost window appears. Click **OK** button to continue.

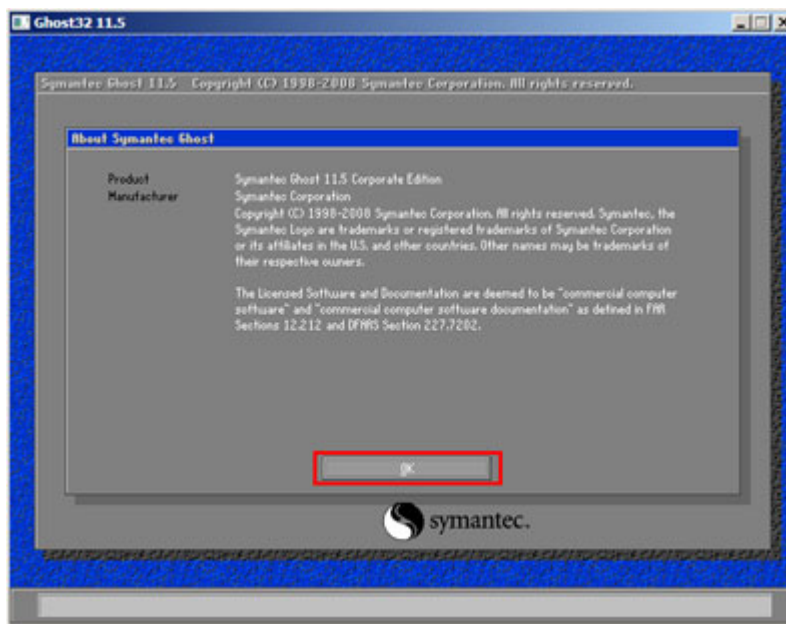

Figure C-9: About Symantec Ghost Window

Step 4: Use mouse to navigate to the option shown below (**Figure C-10**).

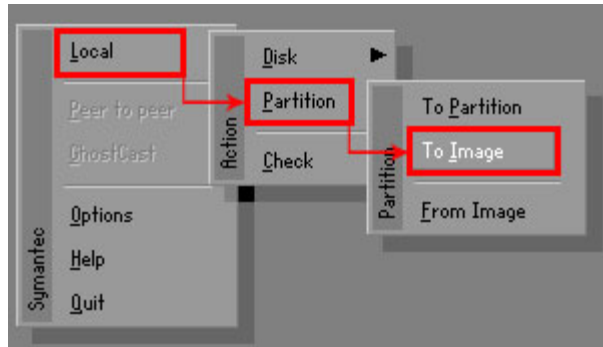

Figure C-10: Symantec Ghost Path

Step 5: Select the local source drive as shown in Figure C-11. Then click OK.

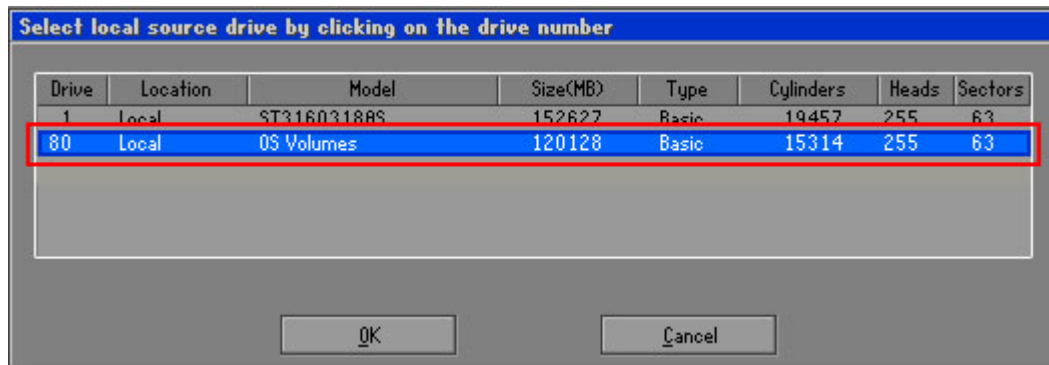

Figure C-11: Select a Local Source Drive

Step 6: Select a source partition from basic drive as shown in Figure C-12. Then click OK.

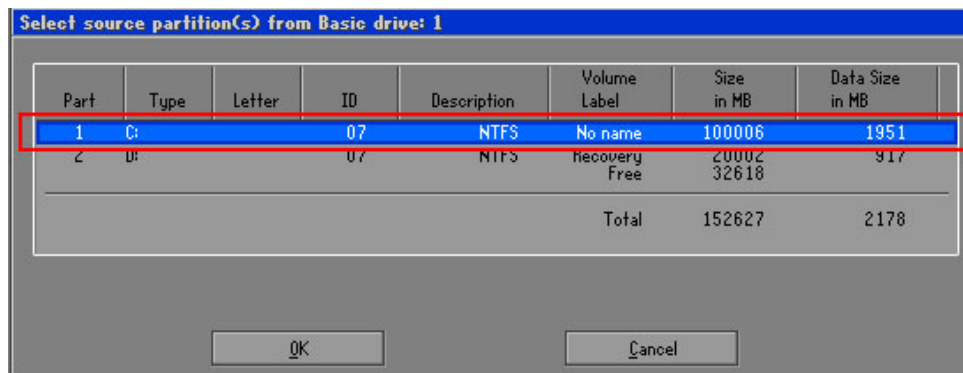

Figure C-12: Select a Source Partition from Basic Drive

WSB-G41A CPU Card

Step 7: Select **1.2: [Recovery] NTFS drive** and enter a file name called **iei** (Figure C-13). Click **Save**. The factory default image will then be saved in the selected recovery drive and named **IEI.GHO**.



WARNING:

The file name of the factory default image must be **iei.GHO**.

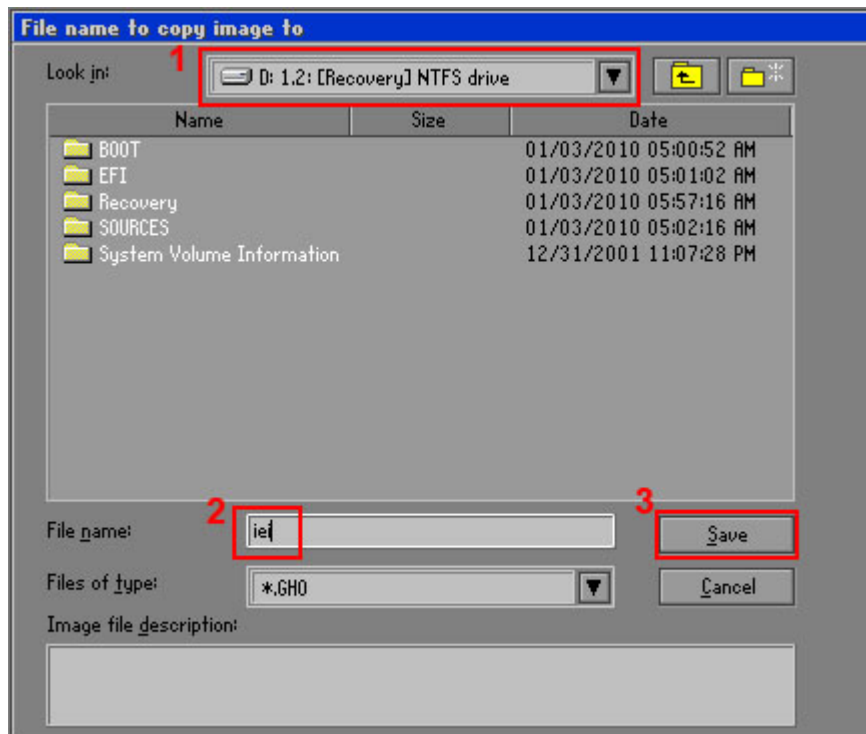

Figure C-13: File Name to Copy Image to

Step 8: When the Compress Image screen in **Figure C-14** prompts, click **High** to make the image file smaller.

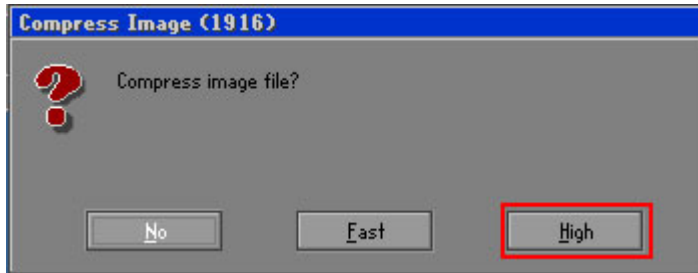

Figure C-14: Compress Image

Step 9: The Proceed with partition image creation window appears, click **Yes** to continue.

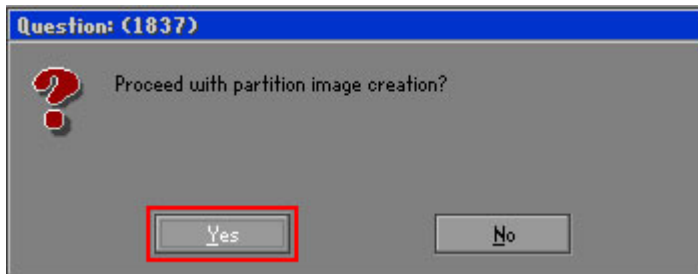

Figure C-15: Image Creation Confirmation

Step 10: The Symantec Ghost starts to create the factory default image (**Figure C-16**).

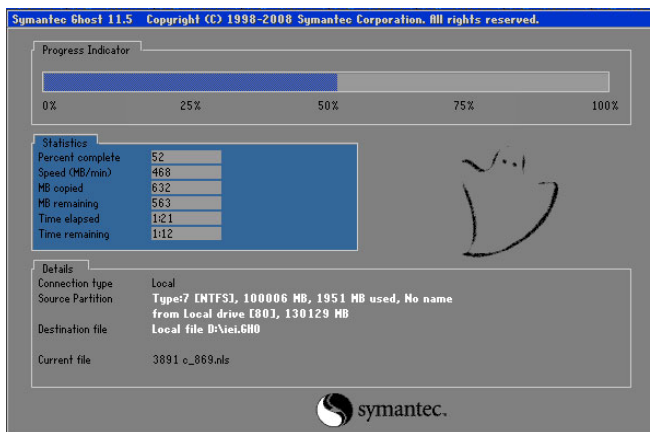

Figure C-16: Image Creation Complete

WSB-G41A CPU Card

Step 11: When the image creation completes, a screen prompts as shown in **Figure C-18**.

Click **Continue** and close the Ghost window to exit the program.

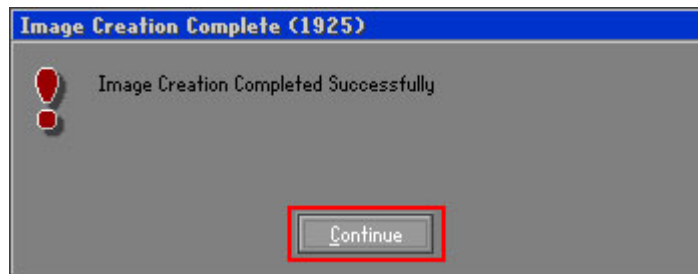

Figure C-17: Image Creation Complete

Step 12: The recovery tool main menu window is shown as below. Press any key to reboot the system.

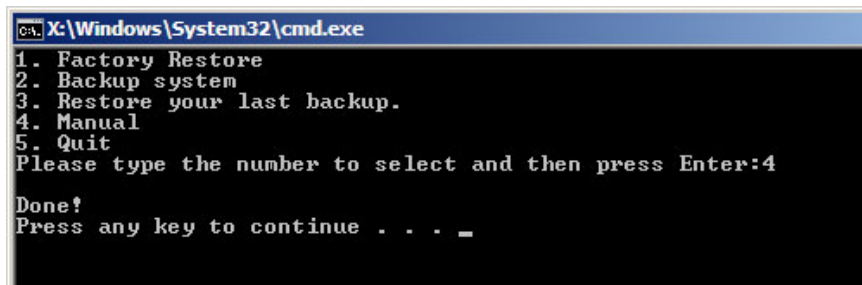

Figure C-18: Press Any Key to Continue

C.3 Setup Procedure for Linux

The initial setup procedures for Linux system are mostly the same with the procedure for Microsoft Windows. Please follow the steps below to setup recovery tool for Linux OS.

Step 1: Hardware and BIOS setup. Refer to **Section C.2.1**.

Step 2: Install Linux operating system. Make sure to install GRUB (v0.97 or earlier) MBR type and Ext3 partition type. Leave enough space on the hard drive to create the recover partition later.



NOTE:

If the Linux OS is not installed with GRUB (v0.97 or earlier) and Ext3, the Symantec Ghost may not function properly.

While installing Linux OS, please create two partitions:

- Partition 1: /
- Partition 2: **SWAP**



NOTE:

Please reserve enough space for partition 3 for saving recovery images.

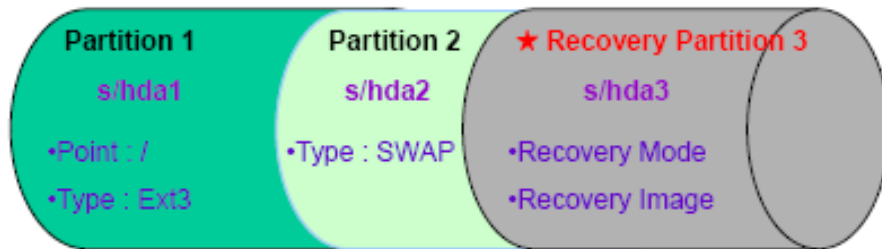

Figure C-19: Partitions for Linux

Step 3: Create a recovery partition. Insert the recovery CD into the optical disk drive.

Follow **Step 1 ~ Step 3** described in **Section C.2.2**. Then type the following commands (marked in red) to create a partition for recovery images.

```
system32>diskpart
DISKPART>list vol
DISKPART>sel disk 0
DISKPART>create part pri size= ____
DISKPART>assign letter=N
DISKPART>exit
```

WSB-G41A CPU Card

```
system32>format N: /fs:ntfs /q /v:Recovery /y
```

```
system32>exit
```

Step 4: Build-up recovery partition. Press any key to boot from the recovery CD. It will take a while to launch the recovery tool. Please be patient. When the recovery tool setup menu appears, type <3> and press <Enter> (**Figure C-20**). The Symantec Ghost window appears and starts configuring the system to build-up a recovery partition. After completing the system configuration, press any key to reboot the system. Eject the recovery CD.

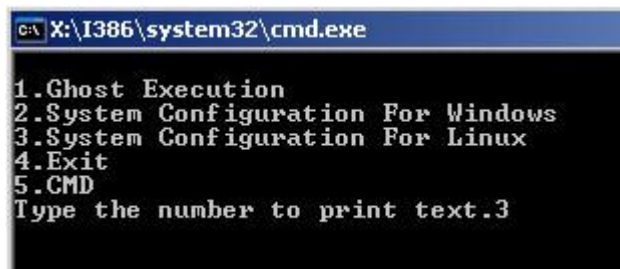

```
C:\X:\I386\system32\cmd.exe
1.Ghost Execution
2.System Configuration For Windows
3.System Configuration For Linux
4.Exit
5.CMD
Type the number to print text.3
```

Figure C-20: System Configuration for Linux

Step 5: Access the recovery tool main menu by modifying the “menu.lst”. To first access the recovery tool main menu, the menu.lst must be modified. In Linux system, enter Administrator (root). When prompt appears, type:

```
cd /boot/grub
```

```
vi menu.lst
```

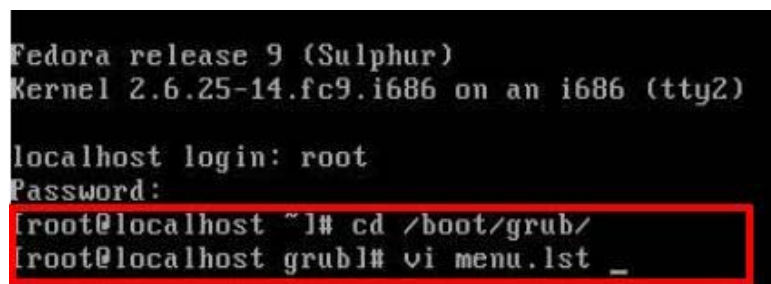

```
Fedora release 9 (Sulphur)
Kernel 2.6.25-14.fc9.i686 on an i686 (tty2)

localhost login: root
Password:
[root@localhost ~]# cd /boot/grub/
[root@localhost grub]# vi menu.lst _
```

Figure C-21: Access menu.lst in Linux (Text Mode)

Step 6: Modify the menu.lst as shown below.

```
#boot=/dev/sda
default=0
timeout=10 ← Modify timeout=10
splashimage=(hd0,0)/grub/splash.xpm.gz
hiddenmenu
title Fedora (2.6.25-14.fc9.i686)
    root (hd0,0)
    kernel /vmlinuz-2.6.25-14.fc9.i686 ro root=UUID=10f1acd
    ac38b5c78910 rhgb quiet
    initrd /initrd-2.6.25-14.fc9.i686.img

title Recovery Partition
    root (hd0,2)
    makeactive ← Type command
    chainloader +1
```

- Type command:
title Recovery Partition
root (hd0,2)
makeactive
chainloader +1

Step 7: The recovery tool menu appears. (Figure C-22)

```
1. Factory Restore
2. Backup system
3. Restore your last backup.
4. Manual
5. Quit
Please type the number to select and then press Enter:
```

Figure C-22: Recovery Tool Menu

Step 8: Create a factory default image. Follow **Step 2 ~ Step 12** described in **Section C.2.5** to create a factory default image. [§](#)

Formatted: Bullet

C.4 Recovery Tool Functions

After completing the initial setup procedures as described above, users can access the recovery tool by pressing **<F3>** while booting up the system. The main menu of the recovery tool is shown below.

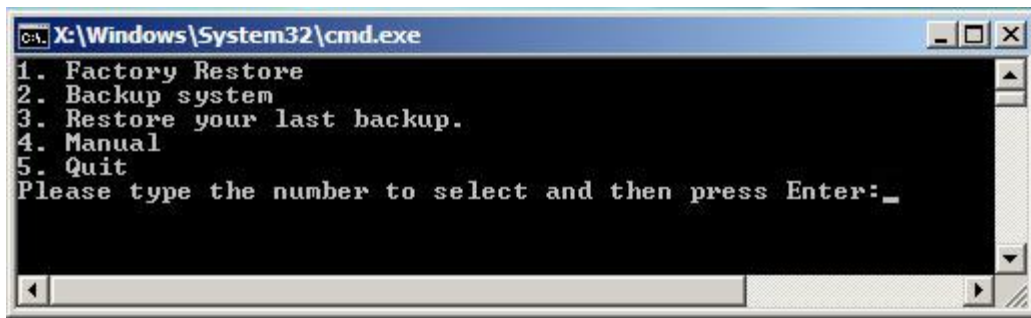

Figure C-23: Recovery Tool Main Menu

The recovery tool has several functions including:

1. **Factory Restore:** Restore the factory default image (iei.GHO) created in **Section C.2.5**.
2. **Backup system:** Create a system backup image (iei_user.GHO) which will be saved in the hidden partition.
3. **Restore your last backup:** Restore the last system backup image
4. **Manual:** Enter the Symantec Ghost window to configure manually.
5. **Quit:** Exit the recovery tool and restart the system.



WARNING:

Please do not turn off the system power during the process of system recovery or backup.



WARNING:

All data in the system will be deleted during the system recovery. Please backup the system files before restoring the system (either Factory Restore or Restore Backup).

C.4.1 Factory Restore

To restore the factory default image, please follow the steps below.

Step 9: Type <1> and press <Enter> in the main menu.

Step 10: The Symantec Ghost window appears and starts to restore the factory default. A factory default image called **ieI.GHO** is created in the hidden Recovery partition.

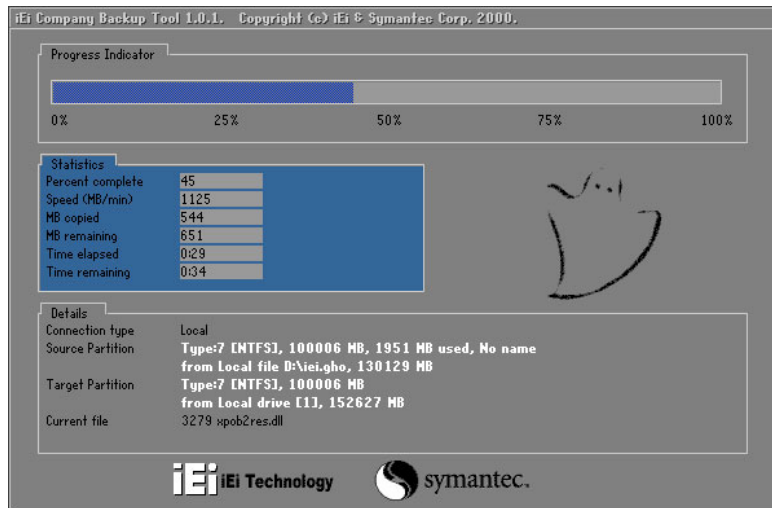

Figure C-24: Restore Factory Default

Step 11: The screen is shown as in **Figure C-25** when completed. Press any key to reboot the system.

Formatted: Bullet

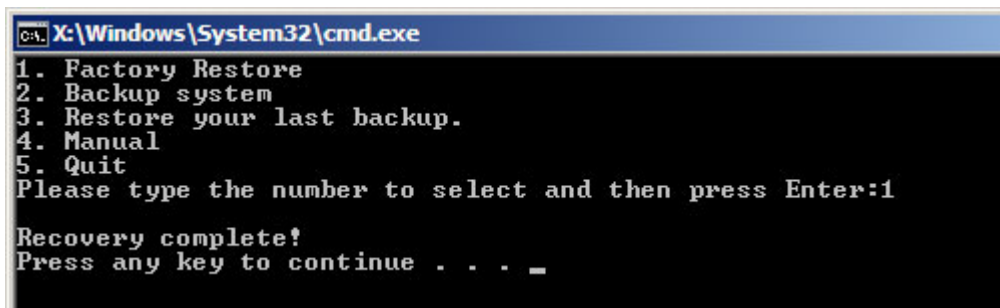

Figure C-25: Recovery Complete Window

WSB-G41A CPU Card

C.4.2 Backup System

To backup the system, please follow the steps below.

Step 12: Type <2> and press <Enter> in the main menu.

Step 13: The Symantec Ghost window appears and starts to backup the system. A backup image called `iei_user.GHO` is created in the hidden Recovery partition.

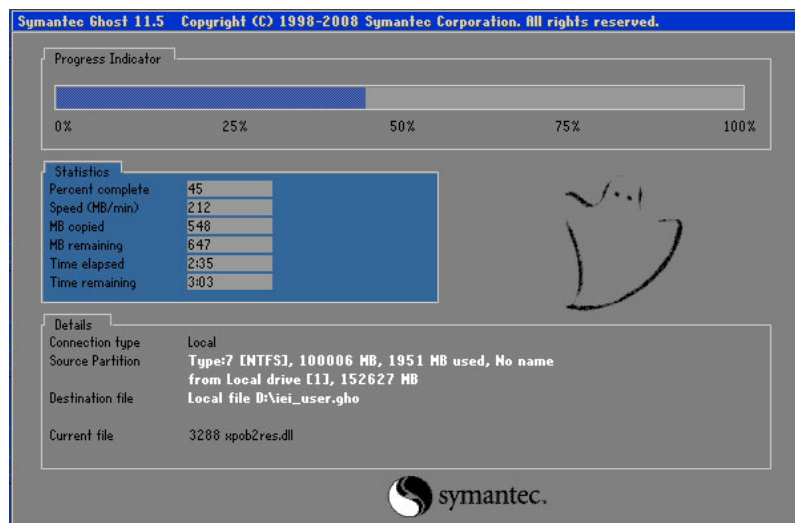

Figure C-26: Backup System

Step 14: The screen is shown as in **Figure C-25** when system backup is completed.

Press any key to reboot the system. 

Formatted: Bullet

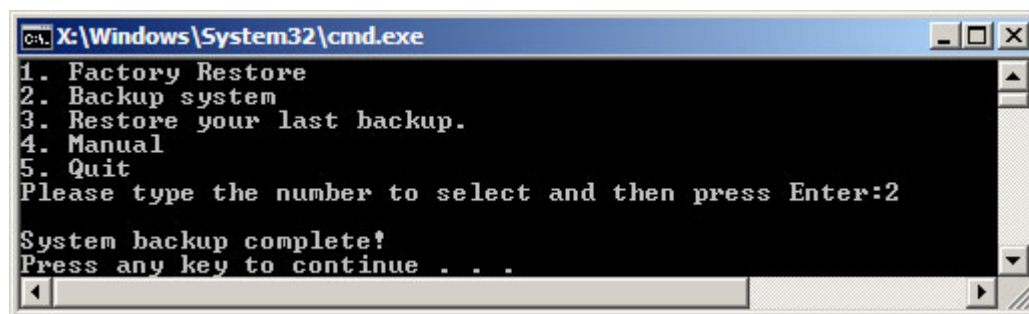

Figure C-27: System Backup Complete Window

C.4.3 Restore Your Last Backup

To restore the last system backup, please follow the steps below.

Step 15: Type <3> and press <Enter> in the main menu.

Step 16: The Symantec Ghost window appears and starts to restore the last backup image (iei_user.GHO).

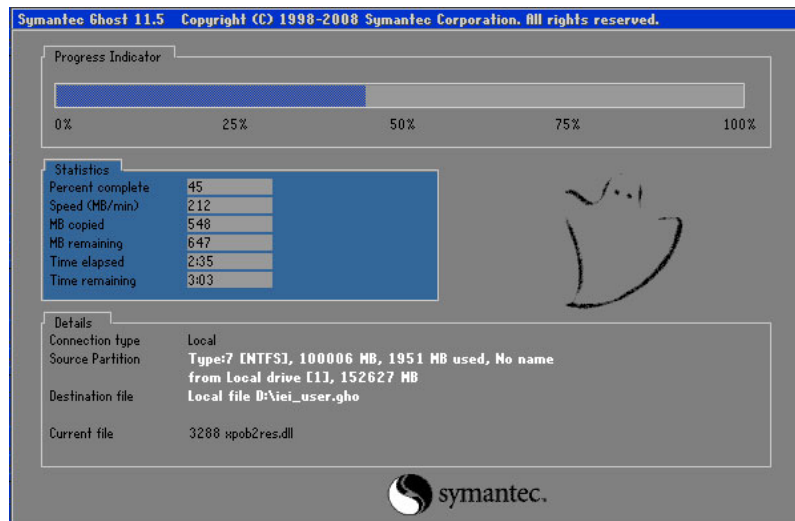

Figure C-28: Restore Backup

Step 17: The screen is shown as in **Figure C-25** when backup recovery is completed.

Press any key to reboot the system. 

Formatted: Bullet

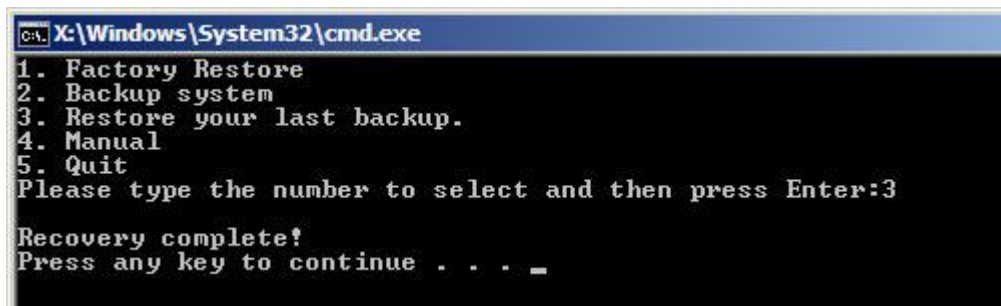

Figure C-29: Restore System Backup Complete Window

WSB-G41A CPU Card

C.4.4 Manual

To restore the last system backup, please follow the steps below.

Step 18: Type <4> and press <Enter> in the main menu.

Step 19: The Symantec Ghost window appears. Use the Ghost program to backup or recover the system manually.

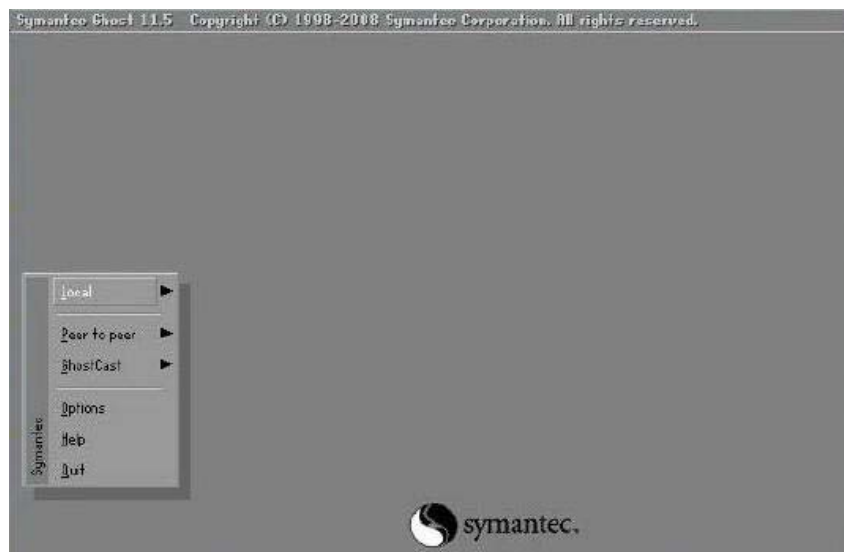

Figure C-30: Symantec Ghost Window

Step 20: When backup or recovery is completed, press any key to reboot the system.

Appendix

D

Watchdog Timer



NOTE:

The following discussion applies to DOS. Contact IEI support or visit the IEI website for drivers for other operating systems.

The Watchdog Timer is a hardware-based timer that attempts to restart the system when it stops working. The system may stop working because of external EMI or software bugs. The Watchdog Timer ensures that standalone systems like ATMs will automatically attempt to restart in the case of system problems.

A BIOS function call (INT 15H) is used to control the Watchdog Timer.

INT 15H:

AH – 6FH Sub-function:	
AL – 2:	Sets the Watchdog Timer's period.
BL:	Time-out value (Its unit-second is dependent on the item "Watchdog Timer unit select" in CMOS setup).

Table D-1: AH-6FH Sub-function

Call sub-function 2 to set the time-out period of Watchdog Timer first. If the time-out value is not zero, the Watchdog Timer starts counting down. When the timer value reaches zero, the system resets. To ensure that this reset condition does not occur, calling sub-function 2 must periodically refresh the Watchdog Timer. However, the watchdog timer is disabled if the time-out value is set to zero.

A tolerance of at least 10% must be maintained to avoid unknown routines within the operating system (DOS), such as disk I/O that can be very time-consuming.

**NOTE:**

The Watchdog Timer is activated through software. The software application that activates the Watchdog Timer must also deactivate it when closed. If the Watchdog Timer is not deactivated, the system will automatically restart after the Timer has finished its countdown.

EXAMPLE PROGRAM:

```
; INITIAL TIMER PERIOD COUNTER
```

```
;
```

```
W_LOOP:
```

```
;
```

```
    MOV     AX, 6F02H    ;setting the time-out value  
    MOV     BL, 30      ;time-out value is 48 seconds  
    INT     15H
```

```
;
```

```
; ADD THE APPLICATION PROGRAM HERE
```

```
;
```

```
    CMP     EXIT_AP, 1   ;is the application over?  
    JNE     W_LOOP      ;No, restart the application  
    MOV     AX, 6F02H   ;disable Watchdog Timer  
    MOV     BL, 0       ;  
    INT     15H
```

```
;
```

```
; EXIT ;
```

Appendix

E

Digital I/O Interface

E.1 Introduction

The digital I/O is used for machine control and automation.

E.2 DIO Connector Pinouts

Located in the Connectors section of this document.

E.3 Assembly Language Example

```

;*****
; DIO Port:  0A21h[3:0] (4 Out)
;           0A22h[3:0] (4 In)
;*****

;=====
; Get current input and output values into AL register
; AL: bit0~bit3 as output value
;     bit4~bit7 as Input value
;=====

        mov     dx, 0A21h      ; GPIO output I/O base address
        in      al, dx        ; Get output status
        jmp     $+2           ; Wait
        jmp     $+2           ; Wait
        and     al, 0Fh
        mov     bl, al        ; Move al to bl temporarily

        inc     dx            ; sets dx to 0A22h
        in      al, dx        ; Get input status
        jmp     $+2           ; Wait
        jmp     $+2           ; Wait
        and     al, 0Fh
        rol     al, 4         ; Shift input values over
        or      al, bl        ; Merge all results into AL
                                ; AL: bit0~bit3 as output value
                                ;     bit4~bit7 as input value

;=====
; Output value (x) to GPIO
; AL: bit0~bit3 as output value
;=====

        mov     al, 0xh       ; x is the output value (0 ~ Fh)
        mov     dx, 0A21h     ; GPIO output I/O base address
        out     dx, al        ; bit0 ~ bit3 as Output value
                                ; bit4 ~ bit7 are Reserved

```

Appendix

F

Hazardous Materials Disclosure

F.1 Hazardous Materials Disclosure Table for IPB Products Certified as RoHS Compliant Under 2002/95/EC Without Mercury

The details provided in this appendix are to ensure that the product is compliant with the Peoples Republic of China (China) RoHS standards. The table below acknowledges the presences of small quantities of certain materials in the product, and is applicable to China RoHS only.

A label will be placed on each product to indicate the estimated “Environmentally Friendly Use Period” (EFUP). This is an estimate of the number of years that these substances would “not leak out or undergo abrupt change.” This product may contain replaceable sub-assemblies/components which have a shorter EFUP such as batteries and lamps. These components will be separately marked.

Please refer to the table on the next page.

WSB-G41A CPU Card

Part Name	Toxic or Hazardous Substances and Elements					
	Lead (Pb)	Mercury (Hg)	Cadmium (Cd)	Hexavalent Chromium (CR(VI))	Polybrominated Biphenyls (PBB)	Polybrominated Diphenyl Ethers (PBDE)
Housing	X	O	O	O	O	X
Display	X	O	O	O	O	X
Printed Circuit Board	X	O	O	O	O	X
Metal Fasteners	X	O	O	O	O	O
Cable Assembly	X	O	O	O	O	X
Fan Assembly	X	O	O	O	O	X
Power Supply Assemblies	X	O	O	O	O	X
Battery	O	O	O	O	O	O

O: This toxic or hazardous substance is contained in all of the homogeneous materials for the part is below the limit requirement in SJ/T11363-2006

X: This toxic or hazardous substance is contained in at least one of the homogeneous materials for this part is above the limit requirement in SJ/T11363-2006

此附件旨在确保本产品符合中国 RoHS 标准。以下表格标示此产品中某有毒物质的含量符合中国 RoHS 标准规定的限量要求。

本产品上会附有“环境友好使用期限”的标签，此期限是估算这些物质“不会有泄漏或突变”的年限。本产品可能包含有较短的环境友好使用期限的可替换元件，像是电池或灯管，这些元件将会单独标示出来。

部件名称	有毒有害物质或元素					
	铅 (Pb)	汞 (Hg)	镉 (Cd)	六价铬 (CR(VI))	多溴联苯 (PBB)	多溴二苯 醚 (PBDE)
壳体	X	O	O	O	O	X
显示	X	O	O	O	O	X
印刷电路板	X	O	O	O	O	X
金属螺帽	X	O	O	O	O	O
电缆组装	X	O	O	O	O	X
风扇组装	X	O	O	O	O	X
电力供应组装	X	O	O	O	O	X
电池	O	O	O	O	O	O

O: 表示该有毒有害物质在该部件所有物质材料中的含量均在 SJ/T11363-2006 标准规定的限量要求以下。
X: 表示该有毒有害物质至少在该部件的某一均质材料中的含量超出 SJ/T11363-2006 标准规定的限量要求。