



**MODEL:**

**WAFER-BT-E38xx1W2**

**3.5" SBC with 22nm Intel® Atom® On-board SoC, VGA, LVDS, iDP, Dual PCIe GbE, USB 3.2 Gen 1, PCIe Mini, SATA 3Gb/s, mSATA, COM, Audio, -40°C – 85°C Operating Temp. and RoHS**

## **User Manual**

# Revision

---

Date	Version	Changes
July 12, 2021	1.20	Updated Section 2.3: Packing List Updated Chapter 6: Software Drivers Changed audio IC to ALC888S Removed SIM slot
June 30, 2017	1.02	Updated BIOS spec on page 8
January 28, 2016	1.01	Modified Section 6.2
November 10, 2015	1.00	Initial release

# Copyright

---

## **COPYRIGHT NOTICE**

The information in this document is subject to change without prior notice in order to improve reliability, design and function and does not represent a commitment on the part of the manufacturer.

In no event will the manufacturer be liable for direct, indirect, special, incidental, or consequential damages arising out of the use or inability to use the product or documentation, even if advised of the possibility of such damages.

This document contains proprietary information protected by copyright. All rights are reserved. No part of this manual may be reproduced by any mechanical, electronic, or other means in any form without prior written permission of the manufacturer.

## **TRADEMARKS**

All registered trademarks and product names mentioned herein are used for identification purposes only and may be trademarks and/or registered trademarks of their respective owners.

# Manual Conventions

---



## **WARNING**

Warnings appear where overlooked details may cause damage to the equipment or result in personal injury. Warnings should be taken seriously.



## **CAUTION**

Cautionary messages should be heeded to help reduce the chance of losing data or damaging the product.



## **NOTE**

These messages inform the reader of essential but non-critical information. These messages should be read carefully as any directions or instructions contained therein can help avoid making mistakes.



## **HOT SURFACE**

This symbol indicates a hot surface that should not be touched without taking care.

# Table of Contents

<b>1 INTRODUCTION.....</b>	<b>1</b>
1.1 INTRODUCTION.....	2
1.2 MODEL VARIATIONS .....	3
1.3 FEATURES.....	3
1.4 CONNECTORS .....	4
1.5 DIMENSIONS.....	6
1.6 DATA FLOW .....	7
1.7 TECHNICAL SPECIFICATIONS .....	8
<b>2 UNPACKING .....</b>	<b>11</b>
2.1 ANTI-STATIC PRECAUTIONS .....	12
2.2 UNPACKING PRECAUTIONS.....	12
2.3 PACKING LIST.....	13
2.4 OPTIONAL ITEMS .....	14
<b>3 CONNECTORS .....</b>	<b>16</b>
3.1 PERIPHERAL INTERFACE CONNECTORS.....	17
3.1.1 WAFER-BT-E38xx1W2 Layout .....	17
3.1.2 Peripheral Interface Connectors .....	18
3.1.3 External Interface Panel Connectors.....	20
3.2 INTERNAL PERIPHERAL CONNECTORS .....	20
3.2.1 +12V DC-IN Power Connector .....	20
3.2.2 Audio Connector .....	21
3.2.3 Battery Connector.....	22
3.2.4 Buzzer Connector.....	23
3.2.5 CPU Fan Connector .....	24
3.2.6 Digital I/O Connector.....	25
3.2.7 Display Port Connector .....	26
3.2.8 Front Panel Connector .....	27
3.2.9 Keyboard and Mouse Connector .....	28
3.2.10 LVDS Backlight Inverter Connector.....	29

3.2.11 LVDS LCD Connector.....	30
3.2.12 LAN LED Connectors .....	31
3.2.13 microSD Slot .....	32
3.2.14 mSATA Module Slot.....	32
3.2.15 PCIe Mini Card Slot .....	34
3.2.16 PCIe Mini Card Slot for 3G Module.....	35
3.2.17 Power Button Connector.....	37
3.2.18 Reset Button Connector .....	38
3.2.19 RS-232 Serial Port Connector .....	39
3.2.20 RS-422/485 Serial Port Connector .....	40
3.2.21 SATA 3Gb/s Drive Connectors.....	41
3.2.22 SATA Power Connectors .....	42
3.2.23 SMBus Connectors.....	43
3.2.24 SPI Flash Connector, BIOS.....	44
3.2.25 SPI Flash Connector, EC .....	45
3.2.26 USB Connectors.....	46
<b>3.3 EXTERNAL PERIPHERAL INTERFACE CONNECTOR PANEL .....</b>	<b>47</b>
3.3.1 LAN Connectors.....	47
3.3.2 USB Connectors.....	48
3.3.3 RS-232 Serial Port Connector .....	49
3.3.4 VGA Connector.....	50
<b>4 INSTALLATION .....</b>	<b>51</b>
4.1 ANTI-STATIC PRECAUTIONS .....	52
4.2 INSTALLATION CONSIDERATIONS.....	52
4.3 FULL-SIZE PCIe MINI CARD INSTALLATION .....	54
4.4 microSD CARD INSTALLATION.....	56
4.5 mSATA MODULE INSTALLATION .....	56
4.6 SYSTEM CONFIGURATION.....	58
4.6.1 AT/ATX Mode Select Switch.....	58
4.6.2 Clear CMOS Button.....	59
4.6.3 LVDS Panel Resolution Selection .....	60
4.6.4 LVDS Voltage Selection.....	61
4.7 CHASSIS INSTALLATION.....	62
4.7.1 Heat Sink.....	62

**WAFER-BT-E38xx1W2**

4.7.2 Motherboard Installation.....	63
4.8 INTERNAL PERIPHERAL DEVICE CONNECTIONS.....	63
4.8.1 AT Power Connection .....	63
4.8.2 SATA Drive Connection .....	65
<b>5 BIOS.....</b>	<b>67</b>
5.1 INTRODUCTION.....	68
5.1.1 Starting Setup.....	68
5.1.2 Using Setup .....	68
5.1.3 Getting Help.....	69
5.1.4 Unable to Reboot after Configuration Changes .....	69
5.1.5 BIOS Menu Bar.....	69
5.2 MAIN.....	70
5.3 ADVANCED.....	71
5.3.1 ACPI Settings.....	72
5.3.2 Super IO Configuration .....	73
5.3.2.1 Serial Port n Configuration .....	73
5.3.2.1.1 Serial Port 1 Configuration .....	74
5.3.2.1.2 Serial Port 2 Configuration .....	75
5.3.2.1.3 Serial Port 3 Configuration .....	76
5.3.3 Hardware Monitor .....	77
5.3.3.1 Smart Fan Mode Configuration .....	78
5.3.4 RTC Wake Settings.....	81
5.3.5 Serial Port Console Redirection .....	82
5.3.5.1 Console Redirection Settings.....	83
5.3.6 IEI Feature.....	85
5.3.7 CPU Configuration.....	86
5.3.8 IDE Configuration .....	87
5.3.9 USB Configuration.....	88
5.4 CHIPSET .....	89
5.4.1 North Bridge Configuration.....	90
5.4.1.1 Intel IGD Configuration.....	91
5.4.2 South Bridge Configuration.....	92
5.4.2.1 PCI Express Configuration .....	94
5.5 SECURITY.....	95

5.6 BOOT.....	96
5.7 EXIT.....	98
<b>6 SOFTWARE DRIVERS.....</b>	<b>100</b>
6.1 AVAILABLE DRIVERS.....	101
6.2 DRIVER DOWNLOAD.....	101
<b>A REGULATORY COMPLIANCE.....</b>	<b>103</b>
<b>B PRODUCT DISPOSAL.....</b>	<b>105</b>
<b>C BIOS MENU OPTIONS.....</b>	<b>107</b>
<b>D DIGITAL I/O INTERFACE.....</b>	<b>110</b>
D.1 INTRODUCTION.....	111
D.2 ASSEMBLY LANGUAGE SAMPLE 1.....	112
D.3 ASSEMBLY LANGUAGE SAMPLE 2.....	112
<b>E WATCHDOG TIMER.....</b>	<b>113</b>
<b>F ERROR BEEP CODE.....</b>	<b>116</b>
F.1 PEI BEEP CODES.....	117
F.2 DXE BEEP CODES.....	117
<b>G HAZARDOUS MATERIALS DISCLOSURE.....</b>	<b>118</b>
G.1 RoHS II DIRECTIVE (2015/863/EU).....	119
G.2 CHINA RoHS.....	120



# List of Figures

Figure 1-1: WAFER-BT-E38xx1W2.....	2
Figure 1-2: Connectors (Front).....	4
Figure 1-3: Connectors (Rear).....	5
Figure 1-4: Dimensions (mm).....	6
Figure 1-5: Data Flow Diagram.....	7
Figure 3-1: Connector and Jumper Locations (Front).....	17
Figure 3-2: Connector and Jumper Locations (Rear).....	18
Figure 3-3: +12V DC-IN Power Connector Location.....	20
Figure 3-4: Audio Connector Location.....	21
Figure 3-5: Battery Connector Location.....	22
Figure 3-6: Buzzer Connector Location.....	23
Figure 3-7: CPU Fan Connector Locations.....	24
Figure 3-8: Digital I/O Connector Location.....	25
Figure 3-9: Display Port Connector Location.....	26
Figure 3-10: Front Panel Connector Location.....	27
Figure 3-11: Keyboard and Mouse Location.....	28
Figure 3-12: Backlight Inverter Connector Location.....	29
Figure 3-13: LVDS Connector Location.....	30
Figure 3-14: LAN LED Connector Location.....	31
Figure 3-15: microSD Card Slot Location.....	32
Figure 3-16: mSATA Module Slot Location.....	33
Figure 3-17: PCIe Mini Card Slot Location.....	34
Figure 3-18: PCIe Mini 3G Module Slot Location.....	36
Figure 3-19: Power Button Connector Location.....	37
Figure 3-20: Reset Button Connector Location.....	38
Figure 3-21: RS-232 Serial Port Connectors Location.....	39
Figure 3-22: RS-422/485 Connector Location.....	40
Figure 3-23: SATA 3Gb/s Drive Connectors Locations.....	41
Figure 3-24: SATA Power Connector Locations.....	42
Figure 3-25: SMBUS Connectors Location.....	43
Figure 3-26: SPI Flash Connector Location.....	44

<b>Figure 3-27: SPI Flash Connector Location</b> .....	<b>45</b>
<b>Figure 3-28: USB Connectors Locations</b> .....	<b>46</b>
<b>Figure 3-29: External Peripheral Interface Connector</b> .....	<b>47</b>
<b>Figure 3-30: LAN Connector</b> .....	<b>47</b>
<b>Figure 3-31: RS-232 Serial Port Connector</b> .....	<b>49</b>
<b>Figure 3-32: VGA Connector</b> .....	<b>50</b>
<b>Figure 4-1: Removing the Retention Screw</b> .....	<b>54</b>
<b>Figure 4-2: Inserting the Full-size PCIe Mini Card into the Slot at an Angle</b> .....	<b>55</b>
<b>Figure 4-3: Securing the Full-size PCIe Mini Card</b> .....	<b>55</b>
<b>Figure 4-4: microSD Card Installation</b> .....	<b>56</b>
<b>Figure 4-5: Removing the Retention Screw</b> .....	<b>57</b>
<b>Figure 4-6: Inserting the mSATA Module into the Slot at an Angle</b> .....	<b>58</b>
<b>Figure 4-7: AT/ATX Mode Select Switch Location</b> .....	<b>59</b>
<b>Figure 4-8: Clear CMOS Button Location</b> .....	<b>60</b>
<b>Figure 4-9: LVDS Panel Resolution Selection Switch Location</b> .....	<b>61</b>
<b>Figure 4-10: LVDS Voltage Selection Jumper Location</b> .....	<b>62</b>
<b>Figure 4-11: Power Cable to Motherboard Connection</b> .....	<b>64</b>
<b>Figure 4-12: Connect Power Cable to Power Supply</b> .....	<b>65</b>
<b>Figure 4-13: SATA Drive Cable Connection</b> .....	<b>66</b>
<b>Figure 6-1: IEI Resource Download Center</b> .....	<b>101</b>

# List of Tables

Table 1-1: WAFER-BT-E38xx1W2 Model Variations.....	3
Table 1-2: Technical Specifications.....	10
Table 3-1: Peripheral Interface Connectors .....	19
Table 3-2: Rear Panel Connectors .....	20
Table 3-3: +12V DC-IN Power Connector Pinouts .....	21
Table 3-4: Audio Connector Pinouts .....	21
Table 3-5: Battery Connector Pinouts .....	22
Table 3-6: Buzzer Connector Pinouts.....	23
Table 3-7: CPU Fan Connector Pinouts.....	24
Table 3-8: Digital I/O Connector Pinouts.....	25
Table 3-9: Display Port Connector Pinouts .....	26
Table 3-10: Front Panel Connector Pinouts.....	27
Table 3-11: Keyboard and Mouse Connector Pinouts .....	28
Table 3-12: Backlight Inverter Connector Pinouts .....	29
Table 3-13: LVDS Connector Pinouts.....	31
Table 3-14: LAN LED Connector Pinouts .....	31
Table 3-15: mSATA Module Slot Pinouts .....	34
Table 3-16: PCIe Mini Card Slot Pinouts .....	35
Table 3-17: PCIe Mini 3G Module Slot Pinouts .....	37
Table 3-18: Power Button Connector Pinouts .....	37
Table 3-19: Reset Button Connector Pinouts .....	38
Table 3-20: RS-232 Serial Port Connector Pinouts .....	39
Table 3-21: RS-422/485 Connector Pinouts .....	40
Table 3-22: DB-9 RS-422/485 Pinouts.....	41
Table 3-23: SATA Power Connector Pinouts.....	42
Table 3-24: SMBUS Connectors Pinouts.....	43
Table 3-25: SPI Flash Connector Pinouts .....	44
Table 3-26: SPI Flash Connector Pinouts .....	45
Table 3-27: USB Connectors Pinouts.....	46
Table 3-28: LAN Pinouts .....	48
Table 3-29: USB 2.0 Port Pinouts.....	48

<b>Table 3-30: USB 3.2 Gen 1 Port Pinouts.....</b>	<b>48</b>
<b>Table 3-31: RS-232 Serial Port Connector Pinouts .....</b>	<b>49</b>
<b>Table 3-32: VGA Connector Pinouts.....</b>	<b>50</b>
<b>Table 4-1: AT/ATX Mode Select Switch Settings.....</b>	<b>59</b>
<b>Table 4-2: Clear CMOS Button Settings .....</b>	<b>59</b>
<b>Table 4-3: LVDS Panel Resolution Selection.....</b>	<b>61</b>
<b>Table 4-4: LVDS Voltage Selection Jumper Settings.....</b>	<b>62</b>
<b>Table 5-1: BIOS Navigation Keys .....</b>	<b>69</b>

# List of BIOS Menus

---

BIOS Menu 1: Main .....	70
BIOS Menu 2: Advanced .....	71
BIOS Menu 3: ACPI Configuration .....	72
BIOS Menu 4: Super IO Configuration.....	73
BIOS Menu 5: Serial Port n Configuration Menu .....	73
BIOS Menu 6: Hardware Monitor.....	77
BIOS Menu 7: Smart Fan Mode Configuration .....	78
BIOS Menu 8: RTC Wake Settings .....	81
BIOS Menu 9: Serial Port Console Redirection .....	82
BIOS Menu 10: Console Redirection Settings.....	83
BIOS Menu 11: IEI Feature .....	85
BIOS Menu 12: CPU Configuration .....	86
BIOS Menu 13: IDE Configuration .....	87
BIOS Menu 14: USB Configuration .....	88
BIOS Menu 15: Chipset .....	90
BIOS Menu 16: North Bridge Configuration .....	90
BIOS Menu 17: Integrated Graphics .....	91
BIOS Menu 18: South Bridge Configuration.....	93
BIOS Menu 19: Console Redirection Settings.....	94
BIOS Menu 20: Security .....	95
BIOS Menu 21: Boot .....	96
BIOS Menu 22: Exit.....	98



Chapter

1

# Introduction

---

## 1.1 Introduction

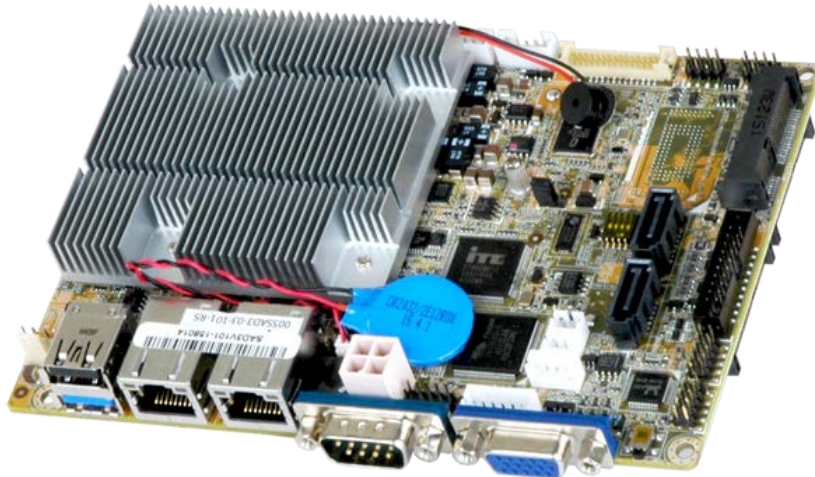

**Figure 1-1: WAFER-BT-E38xx1W2**

The WAFER-BT-E38xx1W2 motherboard is an Intel® Atom® processor platform which supports wide-range operating temperature (-40°C – 85°C). It has 2 GB or 4 GB 1066/1333 MHz DDR3L soldered-down memory.

The WAFER-BT-E38xx1W2 includes a VGA connector, a LVDS connector and an iDP connector. Expansion and I/O include one USB 2.0 connector and one USB 3.2 Gen 1 (5Gb/s) connector on the rear panel, four USB 2.0 connectors by pin header and two SATA 3Gb/s connectors. Serial device connectivity is provided by one internal RS-232 connector, one external RS-232 connector and one internal RS-422/485 connector. Two RJ-45 Ethernet connectors provide the system with smooth connections to an external LAN.



**WAFER-BT-E38xx1W2****1.2 Model Variations**

The model variations of the WAFER-BT-E38xx1W2 series are listed below.

<b>Model No.</b>	<b>SoC</b>	<b>On-board Memory</b>
WAFER-BT-E38451W2	Intel® Atom® E3845 on-board SoC (1.91 GHz, quad-core, 2 MB cache, TDP=10 W)	4 GB
WAFER-BT-E38271W2*	Intel® Atom® E3827 on-board SoC (1.75 GHz, dual-core, 1 MB cache, TDP=8 W)	2 GB Optional 4 GB
WAFER-BT-E38261W2*	Intel® Atom® E3826 on-board SoC (1.46 GHz, dual-core, 1 MB cache, TDP=7 W)	2 GB Optional 4 GB
WAFER-BT-E38151W2*	Intel® Atom® E3815 on-board SoC (1.46 GHz, single-core, 512 KB cache, TDP=5 W)	2 GB

\*By order production, MOQ 100

**Table 1-1: WAFER-BT-E38xx1W2 Model Variations**

**1.3 Features**

Some of the WAFER-BT-E38xx1W2 motherboard features are listed below:

- 3.5" SBC supports 22nm Intel® Atom® on-board SoC
- Dual independent display support
- 2 GB or 4 GB soldered-down 1066/1333 MHz DDR3L memory
- COM, USB 3.2 Gen 1 (5Gb/s), SATA 3Gb/s, PCIe Mini, mSATA and audio support

## 1.4 Connectors

The connectors on the WAFER-BT-E38xx1W2 are shown in the figure below.

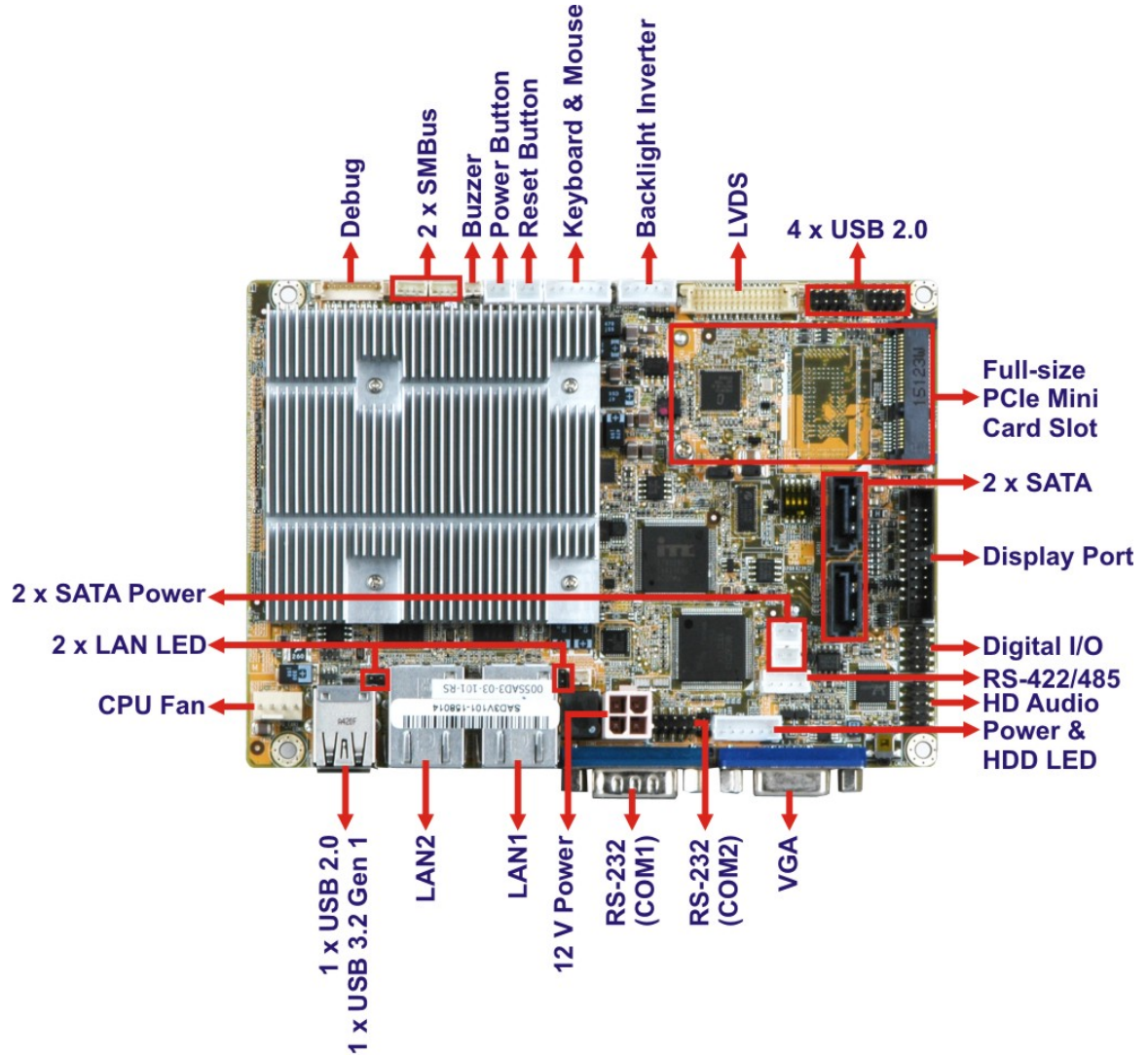

Figure 1-2: Connectors (Front)

WAFER-BT-E38xx1W2

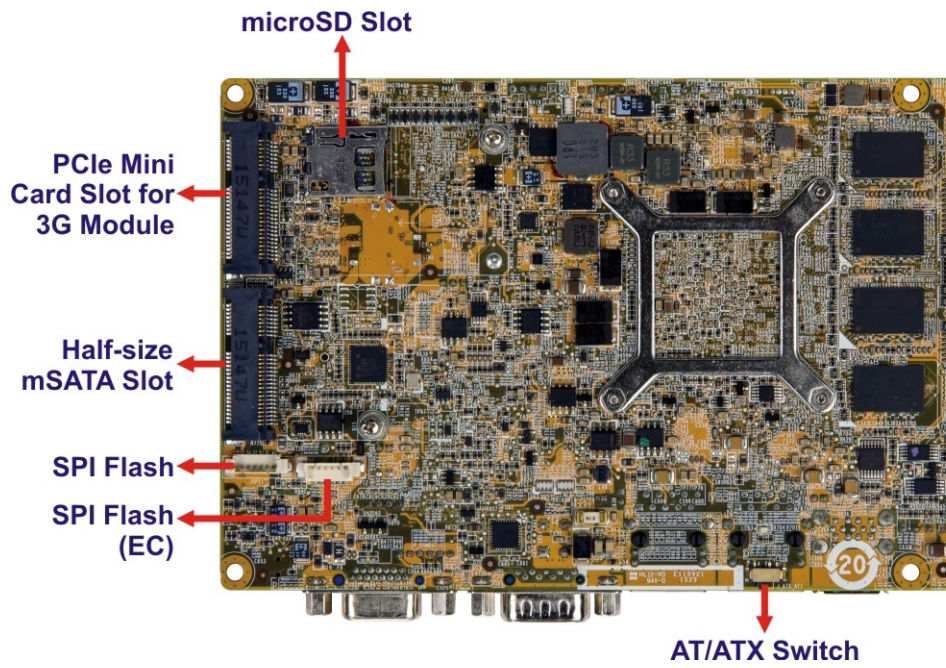

Figure 1-3: Connectors (Rear)

### 1.5 Dimensions

The dimensions of the board are listed below:

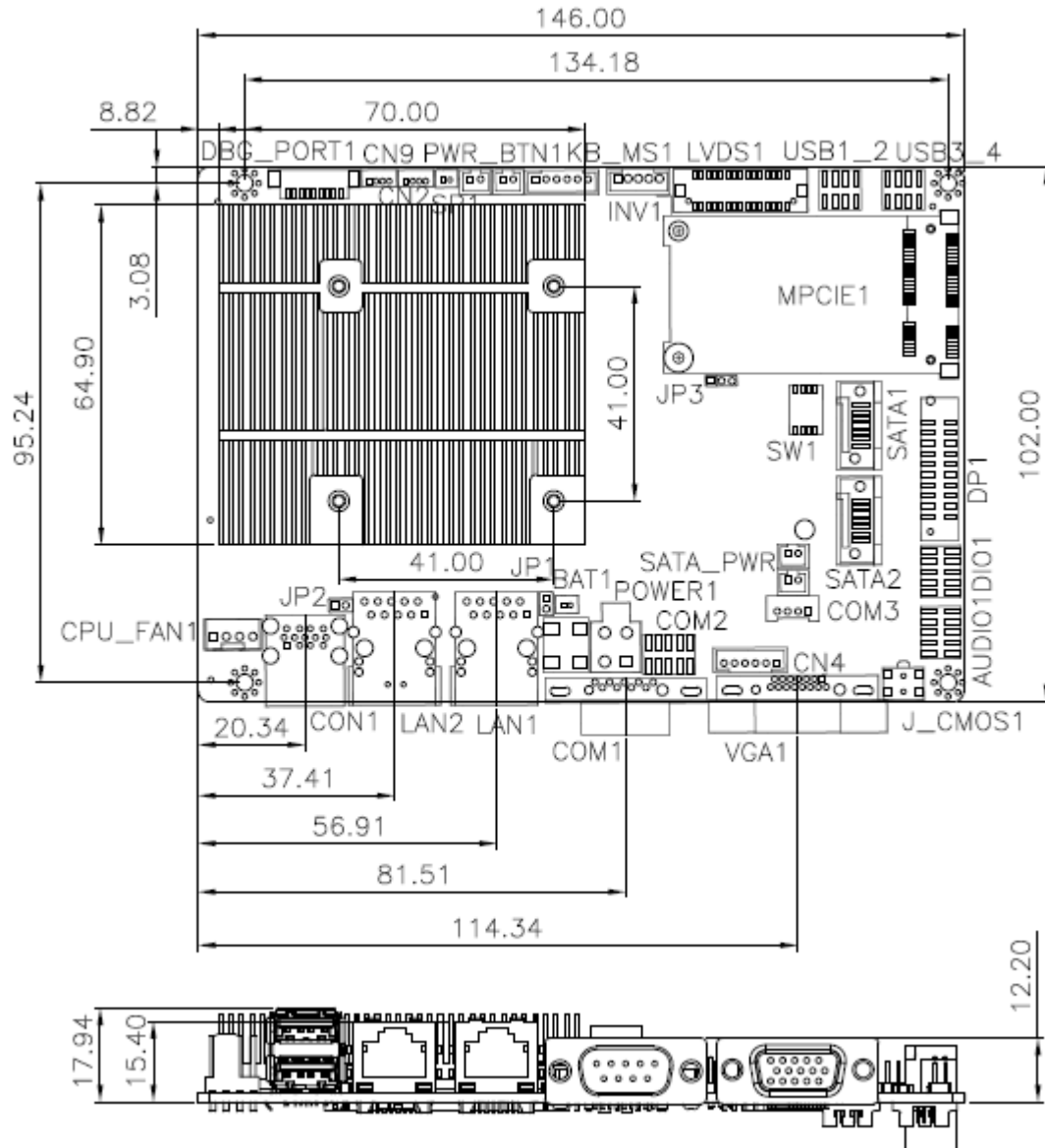

Figure 1-4: Dimensions (mm)

WAFER-BT-E38xx1W2

1.6 Data Flow

Figure 1-5 shows the data flow between the system chipset, the CPU and other components installed on the motherboard.

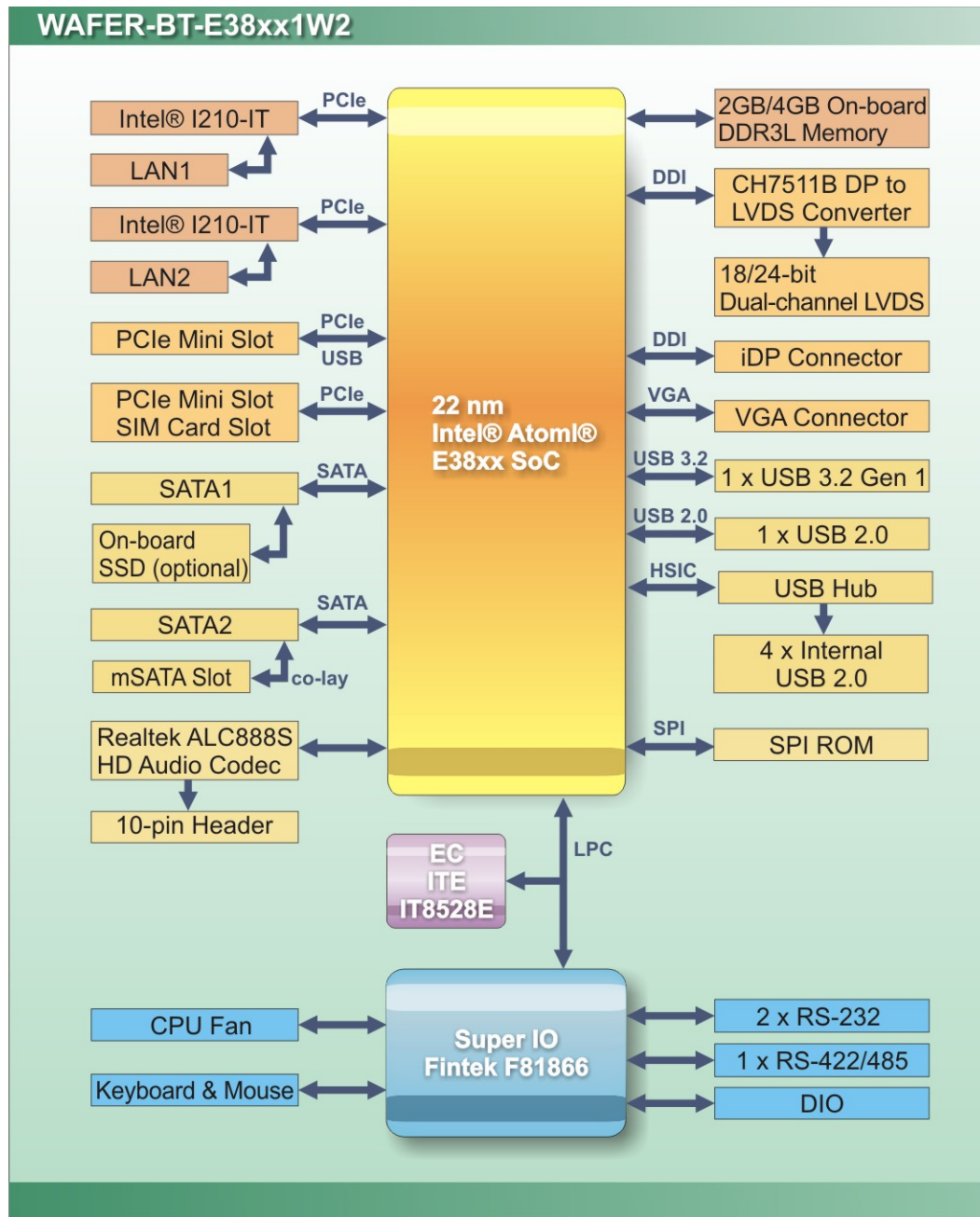

Figure 1-5: Data Flow Diagram

## 1.7 Technical Specifications

WAFER-BT-E38xx1W2 technical specifications are listed below.

Specification	WAFER-BT-E38xx1W2
<b>SoC</b>	<p>Intel® Atom® E3845 on-board SoC (1.91 GHz, quad-core, 2 MB cache, TDP=10 W)</p> <p>Intel® Atom® E3827 on-board SoC (1.75 GHz, dual-core, 1 MB cache, TDP=8 W)</p> <p>Intel® Atom® E3826 on-board SoC (1.46 GHz, dual-core, 1 MB cache, TDP=7 W)</p> <p>Intel® Atom® E3815 on-board SoC (1.46 GHz, single-core, 512 KB cache, TDP=5 W)</p>
<b>BIOS</b>	<p>AMI UEFI BIOS</p> <p>BIOS version: A1xx is for Bay-trail I model (CPU: E38xx)</p> <p>BIOS version: AMxx is for Bay-trail M/D model (if require customize CPU sku: J1900/ N2930/ N2807)</p>
<b>Memory</b>	2 GB or 4 GB (E3845) soldered-down 1066/1333 MHz DDR3L memory (optional 4 GB for E3827and E3826)
<b>Graphics</b>	7 <sup>th</sup> generation Intel® HD Graphics with 4 execution units, supporting DX11.1, OpenGL 4.2 and OpenCL1.2
<b>Display Output</b>	<p>Dual Independent Display</p> <p>1 x VGA (up to 2560x1600 @ 60Hz)</p> <p>1 x 18/24-bit dual-channel LVDS by CH7511B DP to LVDS converter (up to 1920x1200 @ 60Hz)</p> <p>1 x iDP interface for HDMI, LVDS, VGA, DVI, DP (up to 2560x1600 @ 60Hz)</p>
<b>Ethernet</b>	<p>1 x PCIe GbE by Intel® I210-IT controller (LAN1)</p> <p>1 x PCIe GbE by Intel® I210-IT controller (LAN2)</p>
<b>Super IO</b>	Fintek F81866-I
<b>Embedded Controller</b>	ITE IT8528E-I

## WAFER-BT-E38xx1W2

Specification	WAFER-BT-E38xx1W2
<b>Audio</b>	Realtek ALC888S HD codec
<b>Watchdog Timer</b>	Software programmable support 1–255 sec. system reset
<b>I/O Interface</b>	
<b>Audio Connector</b>	1 x Analog audio by 10-pin (2x5) header
<b>Ethernet</b>	Two RJ-45 ports
<b>KB/MS</b>	1 x KB/MS by 6-pin (1x6) header
<b>Serial Ports</b>	1 x RS-422/485 (by pin header) 2 x RS-232 (1 on rear I/O, 1 by pin header)
<b>USB Ports</b>	1 x USB 3.2 Gen 1 (5Gb/s) (on rear I/O) 5 x USB 2.0 (1 on rear I/O, 4 by pin header)
<b>Front Panel</b>	1 x 6-pin (1x6) wafer for power LED & HDD LED 1 x 2-pin (1x2) wafer for power button 1 x 2-pin (1x2) wafer for power reset button
<b>LAN LED</b>	2 x 2-pin header for LAN link LED
<b>Fan</b>	1 x 4-pin CPU fan connector
<b>SMBus</b>	2 x 4-pin (1x4) wafer
<b>Expansion</b>	2 x Full-size PCIe Mini card slot
<b>Digital I/O</b>	8-bit digital I/O (4-bit input, 4-bit output)
<b>Storage</b>	2 x SATA 3G/s with 5V SATA power connectors (w/o RAID) 1 x mSATA slot (half-size PCIe Mini) colay SATA2 1 x microSD socket On-board 4G SSD colay SATA1 (optional)
<b>Environmental and Power Specifications</b>	
<b>Power Supply</b>	12 V DC input only (AT/ATX support)
<b>Power Consumption</b>	+12 V @ 1.32 A (Intel® Atom® processor E3845 with on-board 2 GB 1333 MHz DDR3L memory)
<b>Operating Temperature</b>	-40°C – 85°C

<b>Specification</b>	<b>WAFER-BT-E38xx1W2</b>
<b>Storage Temperature</b>	-40°C – 85°C
<b>Humidity</b>	5% – 95%, non-condensing
<b>Physical Specifications</b>	
<b>Dimensions</b>	146 mm x 102 mm
<b>Weight GW/NW</b>	1000 g / 250 g

Table 1-2: Technical Specifications



Chapter

2

# Unpacking

---

## 2.1 Anti-static Precautions

---



### WARNING!

Static electricity can destroy certain electronics. Make sure to follow the ESD precautions to prevent damage to the product, and injury to the user.

---

Make sure to adhere to the following guidelines:

- **Wear an anti-static wristband:** Wearing an anti-static wristband can prevent electrostatic discharge.
- **Self-grounding:** Touch a grounded conductor every few minutes to discharge any excess static buildup.
- **Use an anti-static pad:** When configuring any circuit board, place it on an anti-static mat.
- **Only handle the edges of the PCB:** Don't touch the surface of the motherboard. Hold the motherboard by the edges when handling.

## 2.2 Unpacking Precautions

When the WAFER-BT-E38xx1W2 is unpacked, please do the following:

- Follow the antistatic guidelines above.
- Make sure the packing box is facing upwards when opening.
- Make sure all the packing list items are present.

**WAFER-BT-E38xx1W2**





**2.3 Packing List**



**NOTE:**









If any of the components listed in the checklist below are missing, do not proceed with the installation. Contact the IEI reseller or vendor the WAFER-BT-E38xx1W2 was purchased from or contact an IEI sales representative directly by sending an email to [sales@ieiworld.com](mailto:sales@ieiworld.com).

The WAFER-BT-E38xx1W2 is shipped with the following components:



Quantity	Item and Part Number	Image
1	WAFER-BT-E38xx1W2 single board computer	
1	SATA with 5V output cable kit	
1	Power cable	
1	Quick Installation Guide	

## 2.4 Optional Items

The following are optional components which may be separately purchased:

Item and Part Number	Image
Dual-port USB cable without bracket (P/N: 32001-008600-200-RS)	
RS-422/485 cable (P/N: 32205-003800-300-RS)	
PS/2 KB/MS Y-cable without bracket (P/N: 32006-001100-201-RS)	
Dual RS-232 cable with bracket (P/N:19800-000300-100-RS)	
Audio cable (P/N: 32007-005200-200-RS)	
DisplayPort to HDMI converter board for iEi IDP connector (P/N: DP-HDMI-R10)	
DisplayPort to 24-bit dual-channel LVDS converter board for iEi IDP connector (P/N: DP-LVDS-R10)	
DisplayPort to VGA converter board for iEi IDP connector (P/N: DP-VGA-R10)	

**WAFER-BT-E38xx1W2**

<p>DisplayPort to DVI-D converter board for iEi IDP connector (P/N: DP-DVI-R10)</p>	 A green printed circuit board (PCB) with a silver metal connector on the left side. The board contains various electronic components, including a central chip and several smaller components.
<p>DisplayPort to DisplayPort converter board for iEi IDP connector (P/N: DP-DP-R10)</p>	 A green printed circuit board (PCB) with two DisplayPort connectors on the left side. The board features a central chip and other electronic components.

Chapter

**3**

# Connectors

---

## WAFER-BT-E38xx1W2

### 3.1 Peripheral Interface Connectors

This chapter details all the jumpers and connectors.

#### 3.1.1 WAFER-BT-E38xx1W2 Layout

The figures below show all the connectors and jumpers.

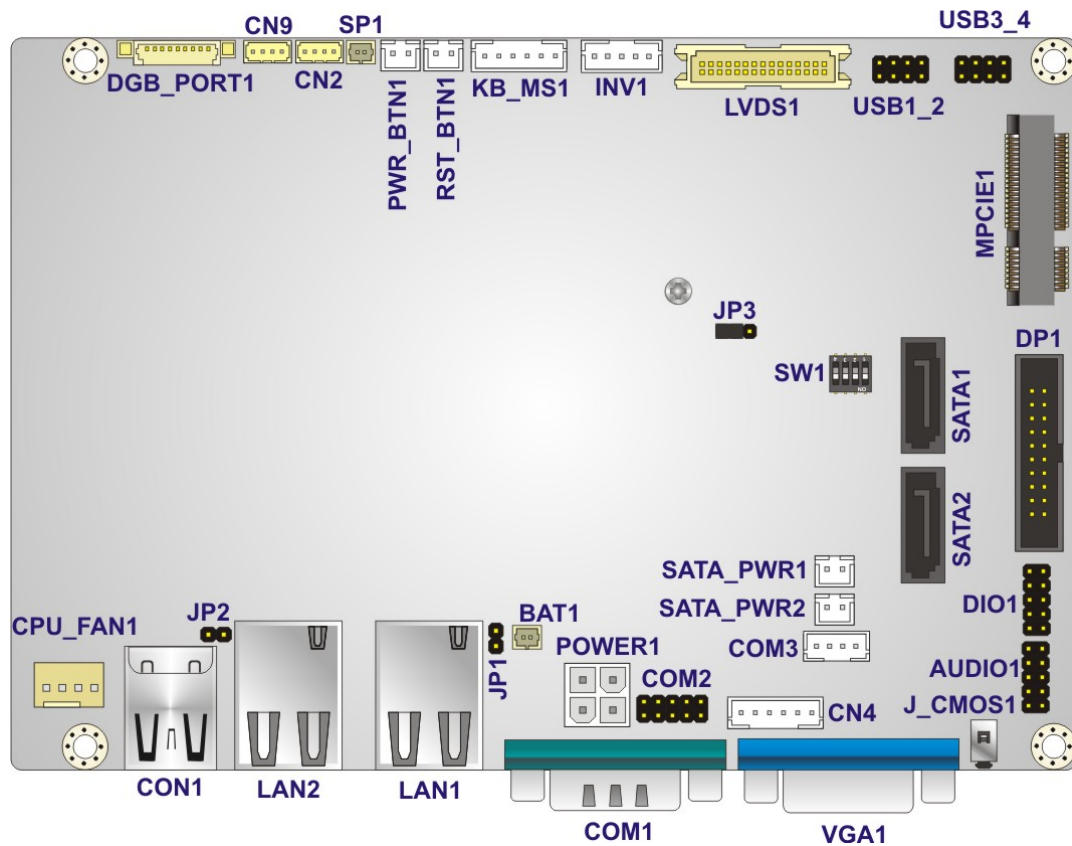
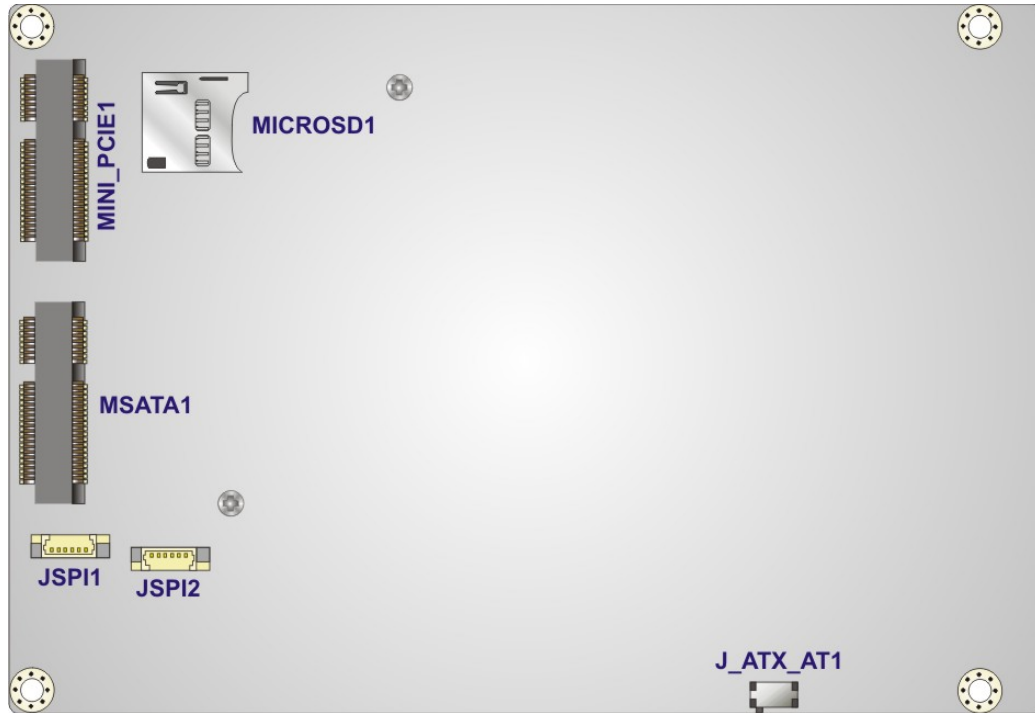

Figure 3-1: Connector and Jumper Locations (Front)



**Figure 3-2: Connector and Jumper Locations (Rear)**

### 3.1.2 Peripheral Interface Connectors

The table below lists all the connectors on the board.

Connector	Type	Label
+12V DC-IN power connector	4-pin Molex	POWER1
Audio connector	10-pin header	AUDIO1
Battery connector	2-pin wafer	BAT1
Buzzer connector	2-pin wafer	SP1
CPU fan connector	4-pin wafer	CPU_FAN1
Digital I/O connector	10-pin header	DIO1
Display port connector	20-pin header	DP1
Front panel connector	6-pin wafer	CN4
Keyboard & mouse connector	6-pin wafer	KB_MS1



## WAFER-BT-E38xx1W2

LCD backlight inverter connector	5-pin wafer	INV1
LVDS LCD connector	30-pin crimp	LVDS1
LAN LED connectors	2-pin header	JP2, JP3
microSD slot	microSD slot	MICROSD1
mSATA module slot	Half-size PCIe Mini slot	MSATA1
PCIe Mini card slot	Full-size PCIe Mini slot	MPCIE1
PCIe Mini card slot for 3G module	Full-size PCIe Mini slot	MINI_PCIE1
Power button connector	2-pin wafer	PWR_BTN1
Reset button connector	2-pin wafer	RST_BTN1
RS-232 serial port connector	10-pin header	COM2
RS-422/485 serial port connector	4-pin wafer	COM3
SATA 3Gb/s drive connectors	7-pin SATA connector	SATA1, SATA2
SATA power connectors	2-pin wafer	SATA_PWR1, SATA_PWR2
SMBus connectors	4-pin wafer	CN2, CN9
SPI flash connector, BIOS	6-pin wafer	JSPI1
SPI flash connector, EC	6-pin wafer	JSPI2
USB 2.0 connectors	8-pin header	USB1_2, USB3_4

**Table 3-1: Peripheral Interface Connectors**

### 3.1.3 External Interface Panel Connectors

The table below lists the connectors on the external I/O panel.

Connector	Type	Label
LAN connectors	RJ-45	LAN1, LAN2
RS-232 serial port connector	DB-9 male	COM1
USB 2.0 and USB 3.2 Gen 1 connector	USB Type-A	CON1
VGA Connector	15-pin female	VGA1

**Table 3-2: Rear Panel Connectors**

## 3.2 Internal Peripheral Connectors

The section describes all of the connectors on the WAFER-BT-E38xx1W2.

### 3.2.1 +12V DC-IN Power Connector

- CN Label:** POWER1
- CN Type:** 4-pin Molex, p=4.2 mm
- CN Location:** See **Figure 3-3**
- CN Pinouts:** See **Table 3-3**

The connector supports the +12V power supply.

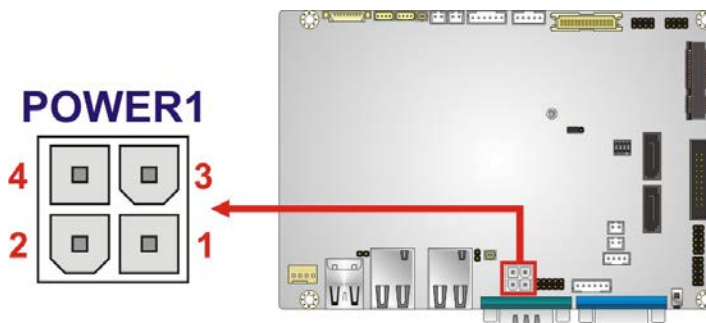

**Figure 3-3: +12V DC-IN Power Connector Location**

**WAFER-BT-E38xx1W2**

PIN NO.	DESCRIPTION	PIN NO.	DESCRIPTION
1	GND	2	GND
3	+12V	4	+12V

**Table 3-3: +12V DC-IN Power Connector Pinouts**

**3.2.2 Audio Connector**

- CN Label:**           **AUDIO1**
- CN Type:**           10-pin header, p=2.00 mm
- CN Location:**      See **Figure 3-4**
- CN Pinouts:**        See **Table 3-4**

The audio connector is connected to external audio devices including speakers and microphones for the input and output of audio signals to and from the system.

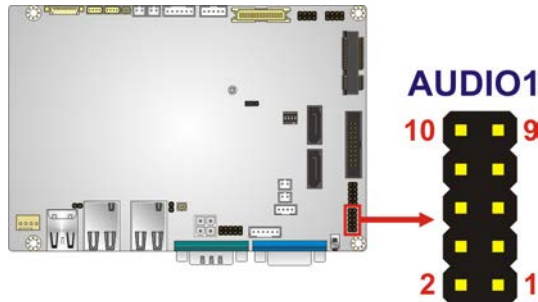

**Figure 3-4: Audio Connector Location**

PIN NO.	DESCRIPTION	PIN NO.	DESCRIPTION
1	LINE_OUTR	2	LINEIN_R
3	Analog_GND	4	Analog_GND
5	LINE_OUTL	6	LINEIN_L
7	Analog_GND	8	Analog_GND
9	MICIN1	10	MICIN1

**Table 3-4: Audio Connector Pinouts**

### 3.2.3 Battery Connector



**CAUTION:**

Risk of explosion if battery is replaced by an incorrect type. Only certified engineers should replace the on-board battery.

Dispose of used batteries according to instructions and local regulations.

- CN Label:**            **BAT1**
- CN Type:**            2-pin wafer, p=1.25 mm
- CN Location:**        See **Figure 3-5**
- CN Pinouts:**         See **Table 3-5**

The battery connector is connected to the system battery. The battery provides power to the system clock to retain the time when power is turned off. **NOTE:** It is recommended to attach the RTC battery onto the system chassis in which the WAFER-BT-E38xx1W2 is installed.

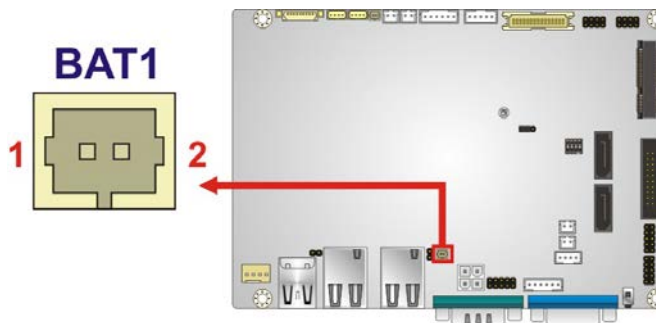

**Figure 3-5: Battery Connector Location**

Pin	Description
1	VBATT
2	GND

**Table 3-5: Battery Connector Pinouts**

## WAFER-BT-E38xx1W2

### 3.2.4 Buzzer Connector

<b>CN Label:</b>	<b>SP1</b>
<b>CN Type:</b>	2-pin wafer, p=1.25 mm
<b>CN Location:</b>	See <b>Figure 3-6</b>
<b>CN Pinouts:</b>	See <b>Table 3-6</b>

The buzzer connector is connected to the buzzer. **NOTE:** If you cannot find a good place to put a buzzer on the WAFER-BT-E38xx1W2, it is recommended to attach the buzzer onto the system chassis in which the WAFER-BT-E38xx1W2 is installed.

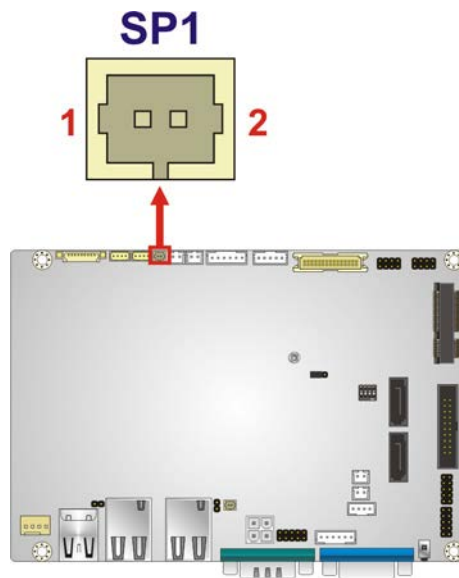

**Figure 3-6: Buzzer Connector Location**

Pin	Description
1	Buzzer+
2	Buzzer-

**Table 3-6: Buzzer Connector Pinouts**

### 3.2.5 CPU Fan Connector

- CN Label:** CPU\_FAN1
- CN Type:** 4-pin wafer, p=2.54 mm
- CN Location:** See **Figure 3-7**
- CN Pinouts:** See **Table 3-7**

The fan connector attaches to a cooling fan.

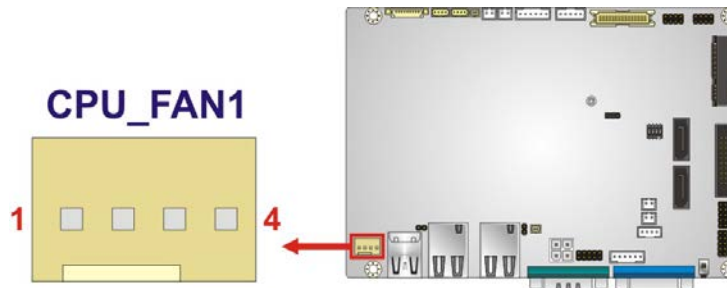

**Figure 3-7: CPU Fan Connector Locations**

Pin	Description
1	GND
2	+12V
3	FANIO1
4	FANOUT1

**Table 3-7: CPU Fan Connector Pinouts**

**WAFER-BT-E38xx1W2**

**3.2.6 Digital I/O Connector**

- CN Label:** DIO1
- CN Type:** 10-pin header, p=2.00 mm
- CN Location:** See **Figure 3-8**
- CN Pinouts:** See **Table 3-8**

The digital I/O connector provides programmable input and output for external devices. The digital I/O provides 4-bit output and 4-bit input.

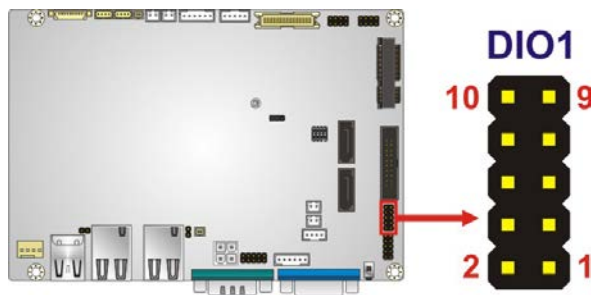

**Figure 3-8: Digital I/O Connector Location**

PIN NO.	DESCRIPTION	PIN NO.	DESCRIPTION
1	GND	2	+5V
3	DOUT3	4	DOUT2
5	DOUT1	6	DOUT0
7	DIN3	8	DIN2
9	DIN1	10	DIN0

**Table 3-8: Digital I/O Connector Pinouts**

### 3.2.7 Display Port Connector

- CN Label:** DP1
- CN Type:** 20-pin box header, p=2.00 mm
- CN Location:** See **Figure 3-9**
- CN Pinouts:** See **Table 3-9**

The display port connector provides flexible display function that supports VGA, DVI, LVDS, HDMI and DisplayPort via the display port convert board.

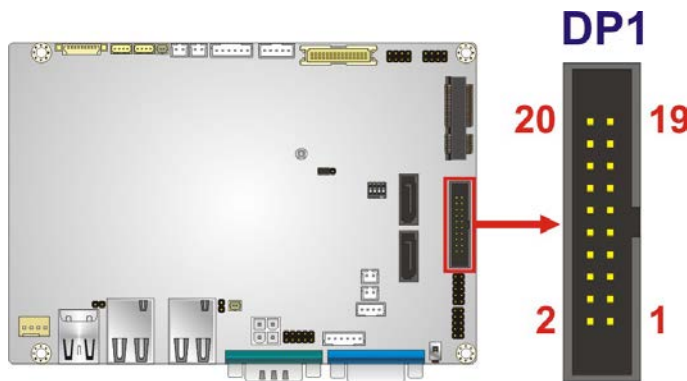

**Figure 3-9: Display Port Connector Location**

Pin	Description	Pin	Description
1	DP_HPD#	2	DPD_AUX_CTRL_P2
3	GND	4	DPD_AUX_CTRL_N2
5	AUX_CTRL_DET_D	6	GND
7	GND	8	C_DPD_LANE2_P
9	C_DPD_LANE3_P	10	C_DPD_LANE2_N
11	C_DPD_LANE3_N	12	GND
13	GND	14	C_DPD_LANE0_P
15	C_DPD_LANE1_P	16	C_DPD_LANE0_N
17	C_DPD_LANE1_N	18	+V3.3S
19	+V5S	20	NC

**Table 3-9: Display Port Connector Pinouts**



**WAFER-BT-E38xx1W2**

**3.2.8 Front Panel Connector**

- CN Label:** CN4
- CN Type:** 6-pin wafer, p=2.00 mm
- CN Location:** See **Figure 3-10**
- CN Pinouts:** See **Table 3-10**

The front panel connector connects to the indicator LEDs on the system front panel.

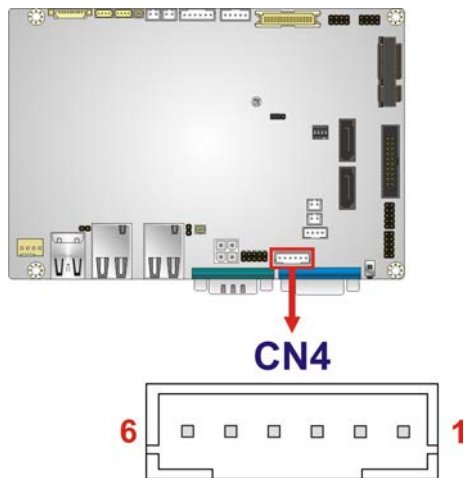

**Figure 3-10: Front Panel Connector Location**

Pin	Description
1	+5V
2	GND
3	PWR_LED+
4	PWR_LED-
5	HDD_LED+
6	HDD_LED-

**Table 3-10: Front Panel Connector Pinouts**

### 3.2.9 Keyboard and Mouse Connector

- CN Label:** KB\_MS1
- CN Type:** 6-pin wafer, p=2.00 mm
- CN Location:** See **Figure 3-11**
- CN Pinouts:** See **Table 3-11**

The keyboard/mouse connector connects to a PS/2 Y-cable that can be connected to a PS/2 keyboard and mouse.

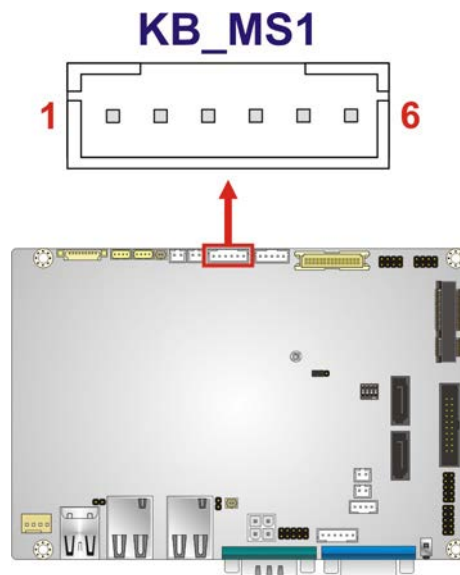

**Figure 3-11: Keyboard and Mouse Location**

Pin	Description
1	VCC
2	Mouse Data
3	Mouse Clock
4	Keyboard Data
5	Keyboard Clock
6	GND

**Table 3-11: Keyboard and Mouse Connector Pinouts**

**WAFER-BT-E38xx1W2**

**3.2.10 LVDS Backlight Inverter Connector**

- CN Label:** INV1
- CN Type:** 5-pin wafer, p=2.00 mm
- CN Location:** See **Figure 3-12**
- CN Pinouts:** See **Table 3-12**

The backlight inverter connector provides power to an LCD panel.

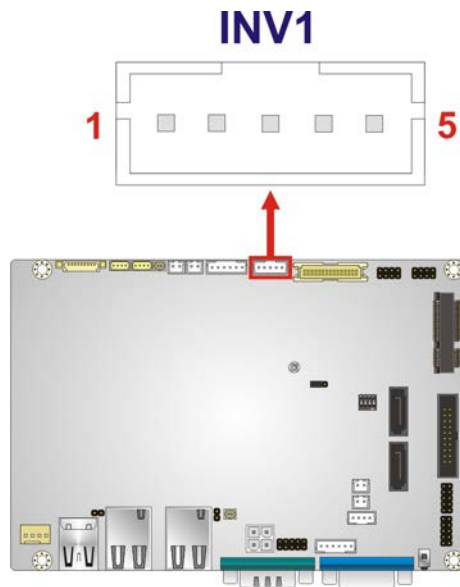

**Figure 3-12: Backlight Inverter Connector Location**

Pin	Description
1	BRIGHTNESS
2	GND
3	VCC
4	GND
5	ENABKL

**Table 3-12: Backlight Inverter Connector Pinouts**

### 3.2.11 LVDS LCD Connector

- CN Label:** LVDS1
- CN Type:** 30-pin crimp, p=1.25 mm
- CN Location:** See **Figure 3-13**
- CN Pinouts:** See **Table 3-13**

The LVDS connector is for an LCD panel connected to the board.

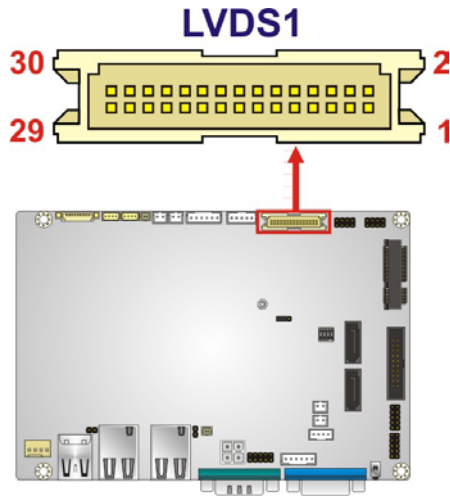

**Figure 3-13: LVDS Connector Location**

Pin	Description	Pin	Description
1	GROUND	2	GROUND
3	LVDS_A_TX0-P	4	LVDS_A_TX0-N
5	LVDS_A_TX1-P	6	LVDS_A_TX1-N
7	LVDS_A_TX2-P	8	LVDS_A_TX2-N
9	LVDS_A_TXCLK-P	10	LVDS_A_TXCLK-N
11	LVDS_A_TX3-P	12	LVDS_A_TX3-N
13	GROUND	14	GROUND
15	LVDS_B_TX0-P	16	LVDS_B_TX0-N
17	LVDS_B_TX1-P	18	LVDS_B_TX1-N
19	LVDS_B_TX2-P	20	LVDS_B_TX2-N
21	LVDS_B_TXCLK-P	22	LVDS_B_TXCLK-N
23	LVDS_B_TX3-P	24	LVDS_B_TX3-N

**WAFER-BT-E38xx1W2**

Pin	Description	Pin	Description
25	GROUND	26	GROUND
27	+LCD VCC	28	+LCD VCC
29	+LCD VCC	30	+LCD VCC

**Table 3-13: LVDS Connector Pinouts**

**3.2.12 LAN LED Connectors**

- CN Label:** JP1, JP2
- CN Type:** 2-pin header, p=2.00 mm
- CN Location:** See **Figure 3-14**
- CN Pinouts:** See **Table 3-14**

The LAN LED connectors connect to the LAN link LEDs on the system.

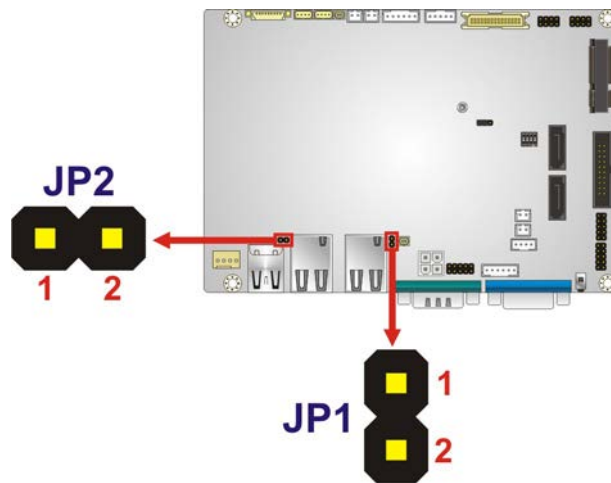

**Figure 3-14: LAN LED Connector Location**

Pin	Description
1	+3.3VLAN
2	LAN_LED_LINK#

**Table 3-14: LAN LED Connector Pinouts**

### 3.2.13 microSD Slot

<b>CN Label:</b>	<b>MICROSD1</b>
<b>CN Type:</b>	microSD card slot
<b>CN Location:</b>	See <b>Figure 3-15</b>

The microSD card slot accepts a microSD card for storage.

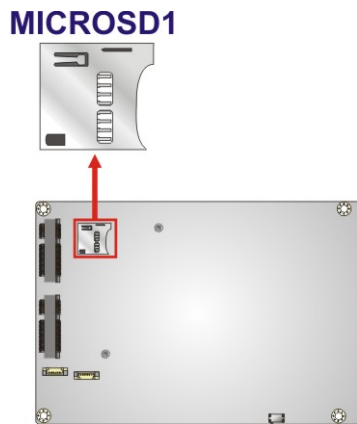

Figure 3-15: microSD Card Slot Location

### 3.2.14 mSATA Module Slot



#### CAUTION:

If an mSATA module is installed in the mSATA slot (MSATA1), the SATA port 2 (SATA2) will be disabled. Choose either the SATA2 connector or the mSATA module for storage.

---

<b>CN Label:</b>	<b>MSATA1</b>
<b>CN Type:</b>	Half-size PCIe Mini card slot
<b>CN Location:</b>	See <b>Figure 3-16</b>
<b>CN Pinouts:</b>	See <b>Table 3-15</b>

WAFER-BT-E38xx1W2

The PCIe Mini card slot is for installing an mSATA module.

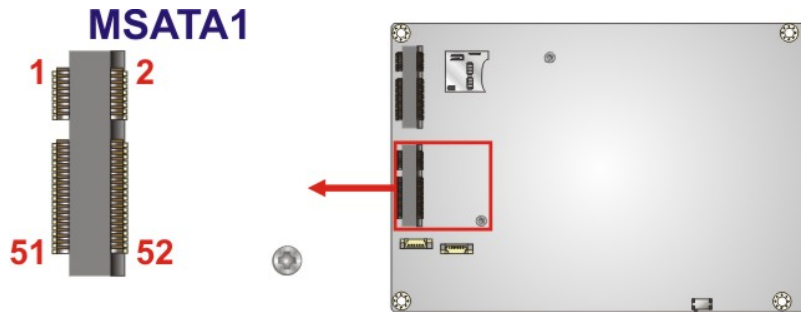

Figure 3-16: mSATA Module Slot Location

Pin	Description	Pin	Description
1	N/C	2	VCC3
3	N/C	4	GND
5	N/C	6	N/C
7	N/C	8	N/C
9	GND	10	N/C
11	N/C	12	N/C
13	N/C	14	N/C
15	GND	16	N/C
17	N/C	18	GND
19	N/C	20	N/C
21	GND	22	N/C
23	SATARXP1	24	VCC3
25	SATARXN1	26	GND
27	GND	28	N/C
29	GND	30	SMBCLK
31	SATATXN1_C	32	SMBDATA
33	SATATXP1_C	34	GND
35	GND	36	N/C
37	N/C	38	N/C
39	VCC3	40	GND
41	VCC3	42	N/C
43	GND	44	N/C

Pin	Description	Pin	Description
45	N/C	46	N/C
47	N/C	48	N/C
49	N/C	50	GND
51	M-SATADET	52	VCC3

**Table 3-15: mSATA Module Slot Pinouts**

### 3.2.15 PCIe Mini Card Slot

- CN Label:** MPCIE1
- CN Type:** Full-size PCIe Mini card slot
- CN Location:** See **Figure 3-17**
- CN Pinouts:** See **Table 3-16**

The PCIe Mini card slot is for installing a PCIe Mini expansion card.

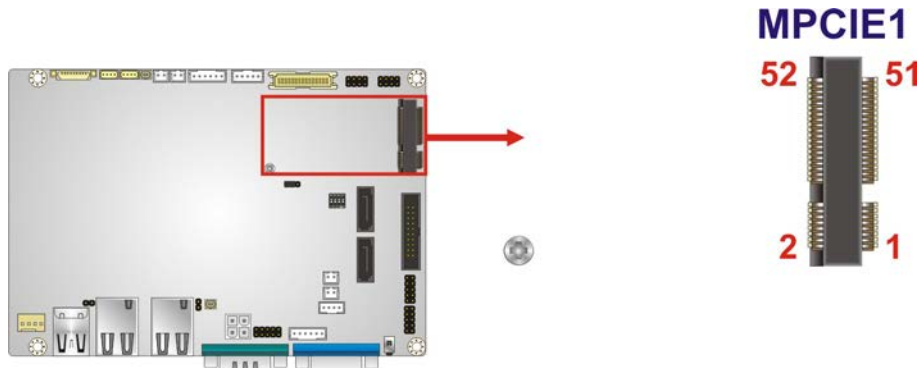

**Figure 3-17: PCIe Mini Card Slot Location**

Pin	Description	Pin	Description
1	PCIE_WAKE#	2	VCC3
3	N/C	4	GND
5	N/C	6	1.5 V
7	VCC3	8	N/C
9	GND	10	N/C
11	CLK-	12	N/C
13	CLK+	14	N/C



## WAFER-BT-E38xx1W2

Pin	Description	Pin	Description
15	GND	16	N/C
17	BUF_PLT_RST#	18	GND
19	N/C	20	VCC3
21	GND	22	BUF_PLT_RST#
23	PCIE_RX4DN_M	24	VCC3
25	PCIE_RX4DP_M	26	GND
27	GND	28	1.5 V
29	GND	30	SMBCLK
31	PCIE_TX4DN_CM	32	SMBDATA
33	PCIE_TX4DP_CM	34	GND
35	GND	36	N/C
37	GND	38	N/C
39	VCC3	40	GND
41	VCC3	42	N/C
43	GND	44	RF_LINK#
45	N/C	46	BLUELED#
47	N/C	48	1.5 V
49	N/C	50	GND
51	N/C	52	VCC3

**Table 3-16: PCIe Mini Card Slot Pinouts**

### 3.2.16 PCIe Mini Card Slot for 3G Module

- CN Label:** MINI\_PCIE1
- CN Type:** Full-size PCIe Mini card slot
- CN Location:** See **Figure 3-18**
- CN Pinouts:** See **Table 3-17**

The PCIe Mini card slot is for installing a 3G module only.

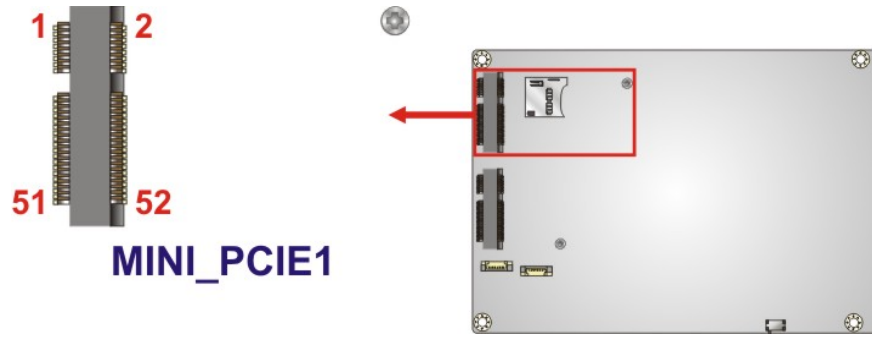

**Figure 3-18: PCIe Mini 3G Module Slot Location**

Pin	Description	Pin	Description
1	PCIE_WAKE#	2	VCC3
3	N/C	4	GND
5	N/C	6	1.5 V
7	GND	8	SIM1_VCC
9	GND	10	SIM1_CIO
11	CLK-	12	SIM1_CLK
13	CLK+	14	SIM1_RST
15	GND	16	N/C
17	BUF_PLT_RST#	18	GND
19	N/C	20	VCC3
21	GND	22	BUF_PLT_RST#
23	PCIE_MINI2_RXN	24	VCC3
25	PCIE_MINI2_RXP	26	GND
27	GND	28	1.5 V
29	GND	30	SMBCLK
31	PCIE_MINI2_TXN	32	SMBDATA
33	PCIE_MINI2_TXP	34	GND
35	GND	36	USB_PN3-
37	GND	38	USB_PP3+
39	VCC3	40	GND
41	VCC3	42	N/C
43	GND	44	N/C
45	N/C	46	N/C

**WAFER-BT-E38xx1W2**

Pin	Description	Pin	Description
47	N/C	48	1.5 V
49	N/C	50	GND
51	N/C	52	VCC3

**Table 3-17: PCIe Mini 3G Module Slot Pinouts**

**3.2.17 Power Button Connector**

- CN Label:** PWR\_BTN1
- CN Type:** 2-pin wafer, p=2.00 mm
- CN Location:** See **Figure 3-19**
- CN Pinouts:** See **Table 3-18**

The power button connector is connected to a power switch on the system chassis to enable users to turn the system on and off.

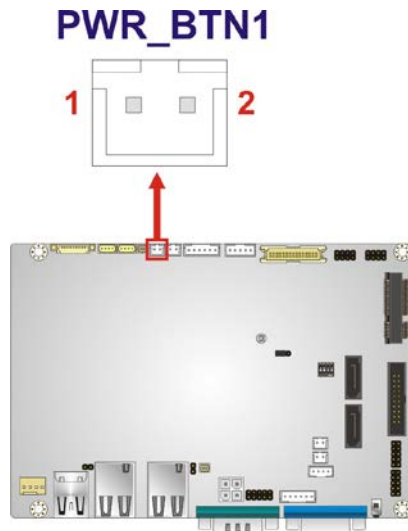

**Figure 3-19: Power Button Connector Location**

Pin	Description
1	PWRBTN_SW#
2	GND

**Table 3-18: Power Button Connector Pinouts**

### 3.2.18 Reset Button Connector

- CN Label:** RST\_BTN1
- CN Type:** 2-pin wafer, p=2.00 mm
- CN Location:** See **Figure 3-20**
- CN Pinouts:** See **Table 3-19**

The reset button connector is connected to a reset switch on the system chassis to enable users to reboot the system when the system is turned on.

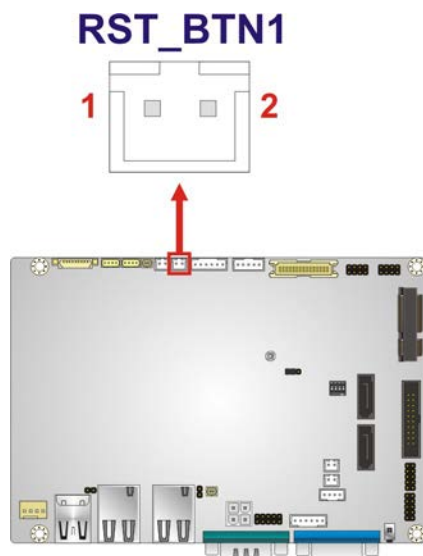

**Figure 3-20: Reset Button Connector Location**

Pin	Description
1	PM_SYSRST_R#
2	GND

**Table 3-19: Reset Button Connector Pinouts**

**WAFER-BT-E38xx1W2**

**3.2.19 RS-232 Serial Port Connector**

- CN Label:** COM2
- CN Type:** 10-pin header, p=2.00 mm
- CN Location:** See **Figure 3-21**
- CN Pinouts:** See **Table 3-20**

The serial connector provides RS-232 connection.

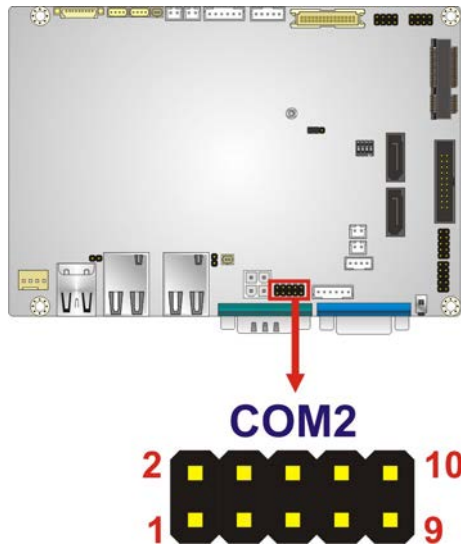

**Figure 3-21: RS-232 Serial Port Connectors Location**

PIN NO.	DESCRIPTION	PIN NO.	DESCRIPTION
1	DCD	2	DSR
3	SIN	4	RTS
5	SOUT	6	CTS
7	DTR	8	RI
9	GND	10	GND

**Table 3-20: RS-232 Serial Port Connector Pinouts**

**3.2.20 RS-422/485 Serial Port Connector**

- CN Label:** COM3
- CN Type:** 4-pin wafer, p=2.00 mm
- CN Location:** See **Figure 3-22**
- CN Pinouts:** See **Table 3-21**

This connector provides RS-422 or RS-485 communications.

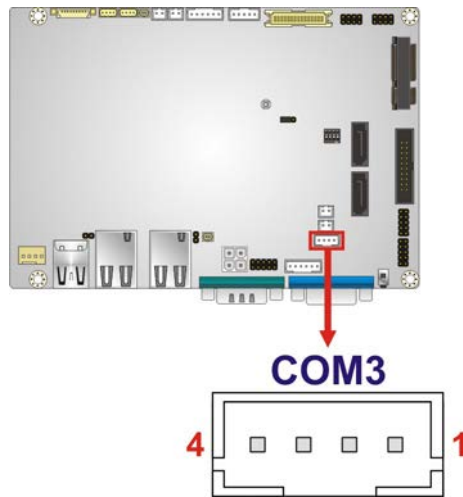

**Figure 3-22: RS-422/485 Connector Location**

Pin	Description
1	RXD422-
2	RXD422+
3	TXD422+/TXD485+
4	TXD422-/TXD485-

**Table 3-21: RS-422/485 Connector Pinouts**

Use the optional RS-422/485 cable to connect to a serial device. The pinouts of the DB-9 connector are listed below.

WAFER-BT-E38xx1W2

RS-422 Pinouts	RS-485 Pinouts

Table 3-22: DB-9 RS-422/485 Pinouts

3.2.21 SATA 3Gb/s Drive Connectors

- CN Label:** SATA1, SATA2
- CN Type:** 7-pin SATA connector
- CN Location:** See Figure 3-23

The SATA 3Gb/s drive connector is connected to a SATA 3Gb/s drive. The SATA 3Gb/s drive transfers data at speeds as high as 3Gb/s.

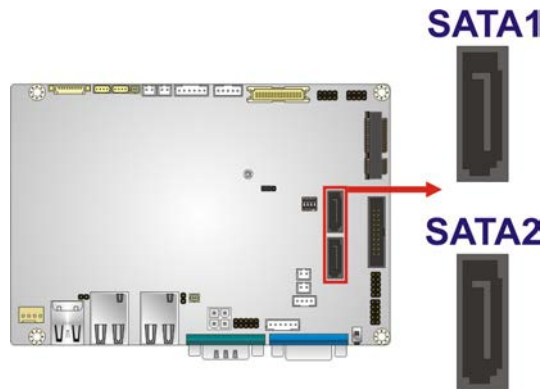

Figure 3-23: SATA 3Gb/s Drive Connectors Locations



**NOTE:**

If the board comes with 4 GB of soldered down SSD, the SATA port 1 (SATA1) will be eliminated and so will the SATA power connector (SATA\_PWR1) for the SATA port 1.

### 3.2.22 SATA Power Connectors

**CN Label:** SATA\_PWR1, SATA\_PWR2

**CN Type:** 2-pin wafer, p=2.00 mm

**CN Location:** See Figure 3-24

**CN Pinouts:** See Table 3-23

The SATA power connector provides +5V power output to the SATA connector.

#### SATA\_PWR1

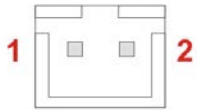

#### SATA\_PWR2

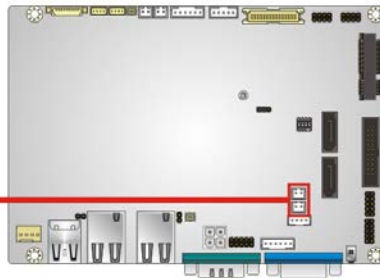
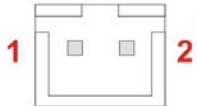

**Figure 3-24: SATA Power Connector Locations**

Pin	Description
1	+5V
2	GND

**Table 3-23: SATA Power Connector Pinouts**



**WAFER-BT-E38xx1W2**

**3.2.23 SMBus Connectors**

- CN Label:** CN2, CN9
- CN Type:** 4-pin wafer, p=1.25 mm
- CN Location:** See **Figure 3-25**
- CN Pinouts:** See **Table 3-24**

The SMBUS (System Management Bus) connector provides low-speed system management communications.

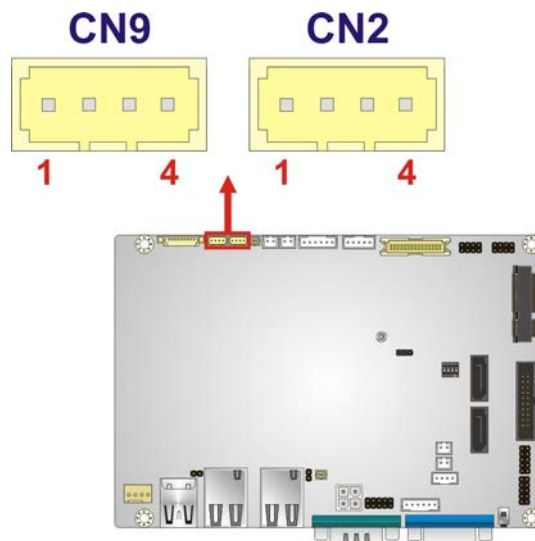

**Figure 3-25: SMBUS Connectors Location**

Pin	Description
1	GND
2	SMBDATA
3	SMBCLK
4	+5V

**Table 3-24: SMBUS Connectors Pinouts**

### 3.2.24 SPI Flash Connector, BIOS

- CN Label:** JSPI1
- CN Type:** 6-pin wafer, p=1.25 mm
- CN Location:** See **Figure 3-26**
- CN Pinouts:** See **Table 3-25**

The 6-pin SPI Flash connector is used to flash the BIOS.

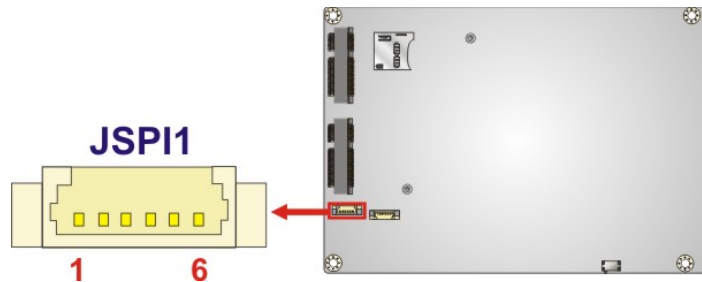

**Figure 3-26: SPI Flash Connector Location**

Pin	Description
1	+1.8VA
2	SPI_CS
3	SPI_SO_SW
4	SPI_CLK_SW
5	SPI_SI_SW
6	GND

**Table 3-25: SPI Flash Connector Pinouts**

**WAFER-BT-E38xx1W2**

**3.2.25 SPI Flash Connector, EC**

- CN Label:** JSPI2
- CN Type:** 6-pin wafer, p=1.25 mm
- CN Location:** See **Figure 3-27**
- CN Pinouts:** See **Table 3-26**

The 6-pin SPI Flash connector is used to flash the embedded controller.

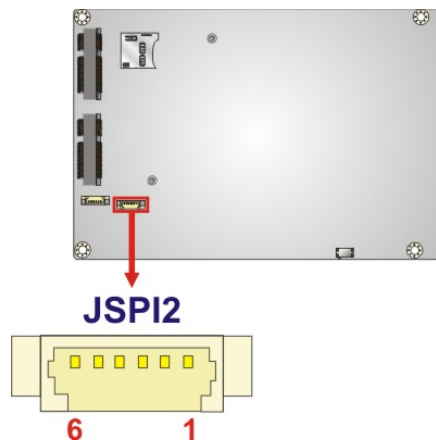

**Figure 3-27: SPI Flash Connector Location**

Pin	Description
1	+3.3VA
2	SPI_CS#0_CN_EC
3	SPI_SO_SW_EC
4	SPI_CLK_SW_EC
5	SPI_SI_SW_EC
6	GND

**Table 3-26: SPI Flash Connector Pinouts**

**3.2.26 USB Connectors**

- CN Label:** USB1\_2, USB3\_4
- CN Type:** 8-pin header, p=2.00 mm
- CN Location:** See **Figure 3-28**
- CN Pinouts:** See **Table 3-27**

The USB connectors provide four USB 2.0 ports by dual-port USB cable.

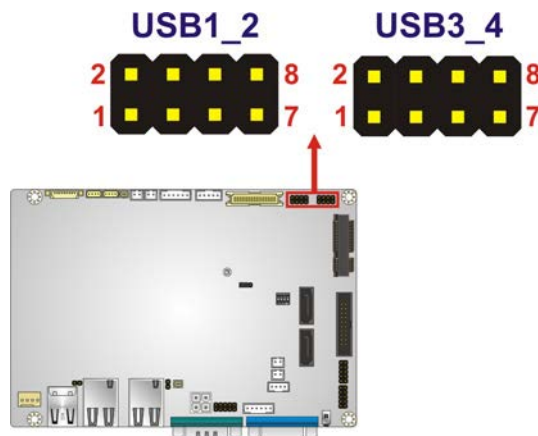

**Figure 3-28: USB Connectors Locations**

PIN NO.	DESCRIPTION	PIN NO.	DESCRIPTION
1	+5V	2	GND
3	-DATA_USB1/3	4	+DATA_USB2/4
5	+DATA_USB1/3	6	-DATA_USB2/4
7	GND	8	+5V

**Table 3-27: USB Connectors Pinouts**

## WAFER-BT-E38xx1W2

### 3.3 External Peripheral Interface Connector Panel

Figure 3-29 shows the WAFER-BT-E38xx1W2 external peripheral interface connector (EPIC) panel. The EPIC panel consists of the following:

- 2 x LAN connectors
- 1 x USB 3.2 Gen 1 (5Gb/s) connector
- 1 x USB 2.0 connector
- 1 x RS-232 serial port connector
- 1 x VGA connector

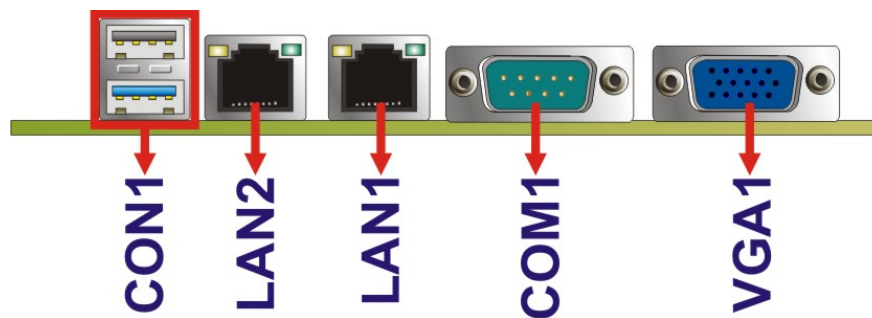

Figure 3-29: External Peripheral Interface Connector

#### 3.3.1 LAN Connectors

<b>CN Label:</b>	LAN1, LAN2
<b>CN Type:</b>	RJ-45
<b>CN Location:</b>	See Figure 3-29
<b>CN Pinouts:</b>	See Figure 3-30 and Table 3-28

The LAN connector connects to a local network.

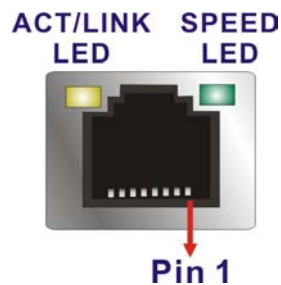

Figure 3-30: LAN Connector

Pin	Description	Pin	Description
1	TRD0+	5	TRD2+
2	TRD0-	6	TRD2-
3	TRD1+	7	TRD3+
4	TRD1-	8	TRD3-

**Table 3-28: LAN Pinouts**

### 3.3.2 USB Connectors

**CN Label:** CON1

**CN Type:** USB Type-A ports

**CN Location:** See **Figure 3-29**

**CN Pinouts:** See **Table 3-29** and **Table 3-30**

The WAFER-BT-E38xx1W2 has one external USB 2.0 port and one external USB 3.2 Gen 1 (5Gb/s) port. The USB connector can be connected to a USB device. The pinouts of USB 2.0 port & USB 3.2 Gen 1 connectors are shown below.

Pin	Description	Pin	Description
1	+5V	2	DATA-
3	DATA+	4	GND

**Table 3-29: USB 2.0 Port Pinouts**

Pin	Description	Pin	Description
1	+5V	2	USB2P0-
3	USB2P0+	4	GND
5	USB3P0_RXDN1	6	USB3P0_RXDP1
7	GND	8	USB3P0_TXDN1
9	USB3P0_TXDP1		

**Table 3-30: USB 3.2 Gen 1 Port Pinouts**

**WAFER-BT-E38xx1W2**

**3.3.3 RS-232 Serial Port Connector**

- CN Label:** COM1
- CN Type:** DB-9 Male
- CN Location:** See **Figure 3-29**
- CN Pinouts:** See **Figure 3-31** and **Table 3-31**

The serial port connects to a RS-232 serial communications device.

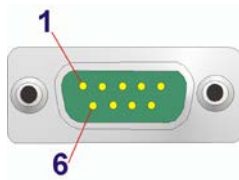

**Figure 3-31: RS-232 Serial Port Connector**

Pin	Description	Pin	Description
1	DCD1	6	DSR1
2	SIN1	7	RTS1
3	SOUT1	8	CTS1
4	DTR1	9	RI1
5	GND		

**Table 3-31: RS-232 Serial Port Connector Pinouts**

### 3.3.4 VGA Connector

- CN Label:** VGA1
- CN Type:** 15-pin female (VGA)
- CN Location:** See **Figure 3-29**
- CN Pinouts:** See **Figure 3-32** and **Table 3-32**

The VGA port connects to a monitor that accepts a standard VGA input.

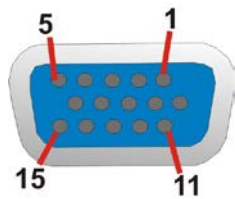

**Figure 3-32: VGA Connector**

Pin	Description	Pin	Description
1	Red	2	Green
3	Blue	4	NC
5	GND	6	GND
7	GND	8	GND
9	VGAVCC	10	HOTPLUG
11	NC	12	DDCDAT
13	HSYNC	14	VSYNC
15	DDCCLK		

**Table 3-32: VGA Connector Pinouts**



Chapter

4

# Installation

---

## 4.1 Anti-static Precautions

---



### WARNING:

Failure to take ESD precautions during the installation of the WAFER-BT-E38xx1W2 may result in permanent damage to the WAFER-BT-E38xx1W2 and severe injury to the user.

---

Electrostatic discharge (ESD) can cause serious damage to electronic components, including the WAFER-BT-E38xx1W2. Dry climates are especially susceptible to ESD. It is therefore critical that whenever the WAFER-BT-E38xx1W2 or any other electrical component is handled, the following anti-static precautions are strictly adhered to.

- **Wear an anti-static wristband:** Wearing a simple anti-static wristband can help to prevent ESD from damaging the board.
- **Self-grounding** Before handling the board, touch any grounded conducting material. During the time the board is handled, frequently touch any conducting materials that are connected to the ground.
- **Use an anti-static pad:** When configuring the WAFER-BT-E38xx1W2, place it on an anti-static pad. This reduces the possibility of ESD damaging the WAFER-BT-E38xx1W2.
- **Only handle the edges of the PCB:** When handling the PCB, hold the PCB by the edges.

## 4.2 Installation Considerations

---



### NOTE:

The following installation notices and installation considerations should be read and understood before installation. All installation notices must be strictly adhered to. Failing to adhere to these precautions may lead to severe damage and injury to the person performing the installation.

---

## WAFER-BT-E38xx1W2

---



### **WARNING:**

The installation instructions described in this manual should be carefully followed in order to prevent damage to the WAFER-BT-E38xx1W2, WAFER-BT-E38xx1W2 components and injury to the user.

---

Before and during the installation please **DO** the following:

- Read the user manual:
  - The user manual provides a complete description of the WAFER-BT-E38xx1W2 installation instructions and configuration options.
- Wear an electrostatic discharge cuff (ESD):
  - Electronic components are easily damaged by ESD. Wearing an ESD cuff removes ESD from the body and helps prevent ESD damage.
- Place the WAFER-BT-E38xx1W2 on an antistatic pad:
  - When installing or configuring the motherboard, place it on an antistatic pad. This helps to prevent potential ESD damage.
- Turn all power to the WAFER-BT-E38xx1W2 off:
  - When working with the WAFER-BT-E38xx1W2, make sure that it is disconnected from all power supplies and that no electricity is being fed into the system.

Before and during the installation of the WAFER-BT-E38xx1W2 **DO NOT:**

- Remove any of the stickers on the PCB board. These stickers are required for warranty validation.
- Use the product before verifying all the cables and power connectors are properly connected.
- Allow screws to come in contact with the PCB circuit, connector pins, or its components.

### 4.3 Full-size PCIe Mini Card Installation

The PCIe Mini card slot allows installation of either a full-size PCIe Mini card. To install a full-size PCIe Mini card, please follow the steps below.

**Step 1:** Locate the PCIe Mini card slot. See **Figure 3-16**.

**Step 2:** Remove the retention screw. Remove the retention screw as shown in **Figure 4-1**.

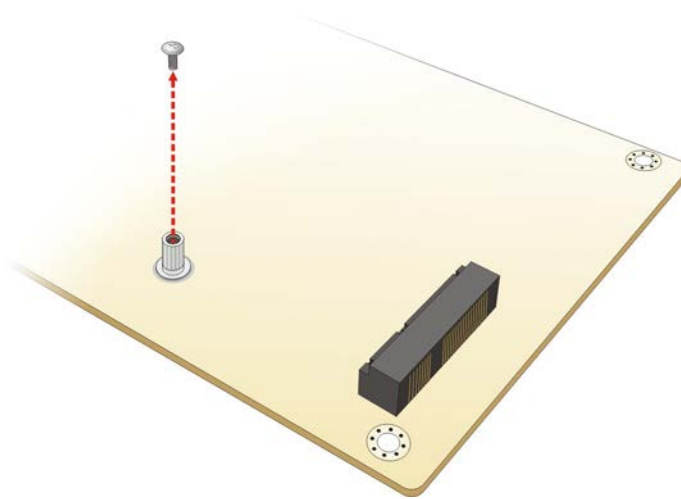

**Figure 4-1: Removing the Retention Screw**

**Step 3:** Insert into the socket at an angle. Line up the notch on the card with the notch on the slot. Slide the PCIe Mini card into the socket at an angle of about 20° (**Figure 4-2**).

## WAFER-BT-E38xx1W2

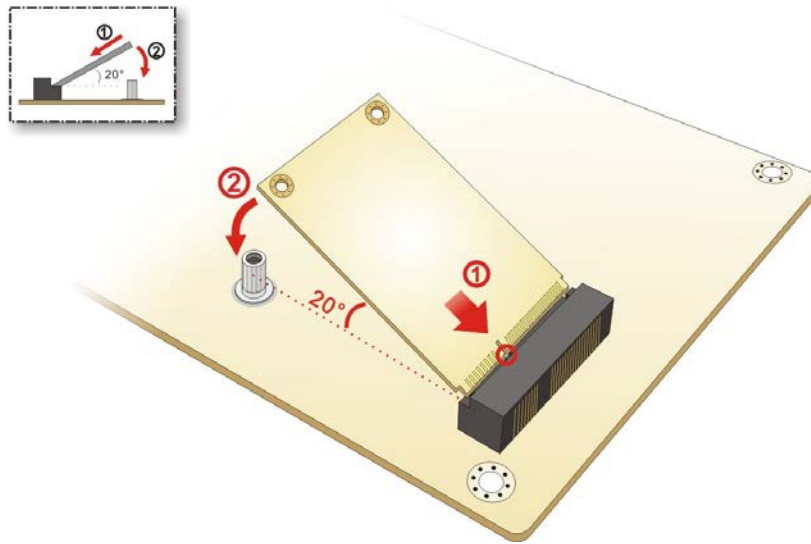

Figure 4-2: Inserting the Full-size PCIe Mini Card into the Slot at an Angle

**Step 4:** Secure the full-size PCIe Mini card. Secure the full-size PCIe Mini card with the retention screw previously removed (Figure 4-3).

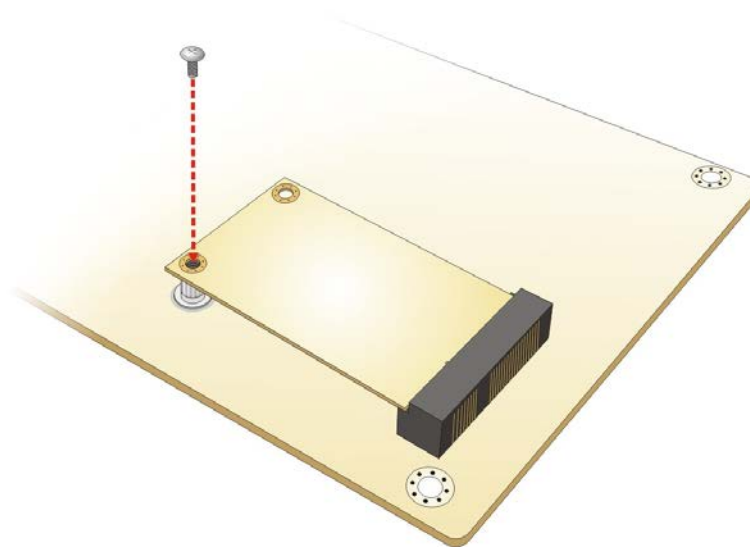

Figure 4-3: Securing the Full-size PCIe Mini Card

## 4.4 microSD Card Installation

To install the microSD card, please follow the steps below.

**Step 1:** Locate the microSD slot.

**Step 2:** Align the microSD card. The label side should be facing away from the board.

The grooves on the microSD slot ensure that the card cannot be inserted the wrong way.

**Step 3:** Insert the microSD card. Push until the microSD card is firmly seated in the slot.

See Figure 4-4.

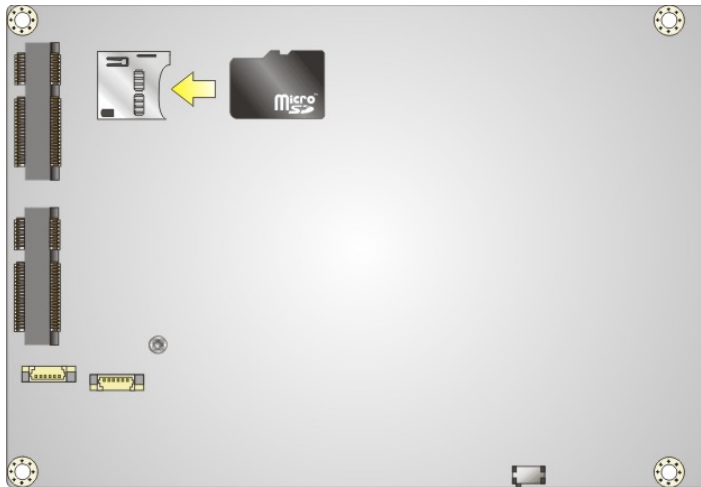

Figure 4-4: microSD Card Installation

## 4.5 mSATA Module Installation



### CAUTION:

If an mSATA module is installed in the mSATA slot (MSATA1), the SATA port 2 (SATA2) will be disabled. Choose either the SATA2 connector or the mSATA module for storage.

---

## WAFER-BT-E38xx1W2

The half-size PCIe Mini card slot allows installation of an mSATA module. To install an mSATA module, please follow the steps below.

**Step 1:** Locate the half-size PCIe Mini card slot. See **Figure 3-16**.

**Step 2:** Remove the retention screw. Remove the retention screw as shown in **Figure 4-5**.

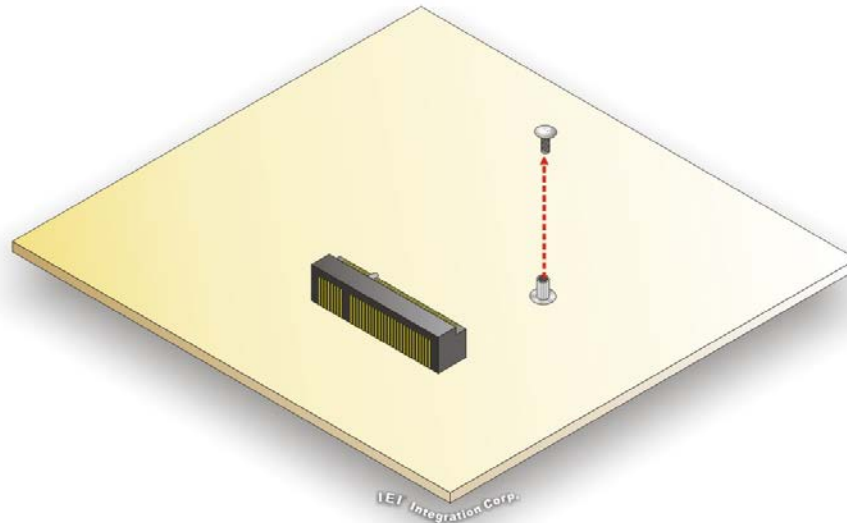

**Figure 4-5: Removing the Retention Screw**

**Step 3:** Insert into the socket at an angle. Line up the notch on the mSATA module with the notch on the slot. Slide the mSATA module into the socket at an angle of about 20° (**Figure 4-6**).

**Step 4:** Secure the mSATA module. Secure the mSATA module with the retention screw previously removed (**Figure 4-6**).

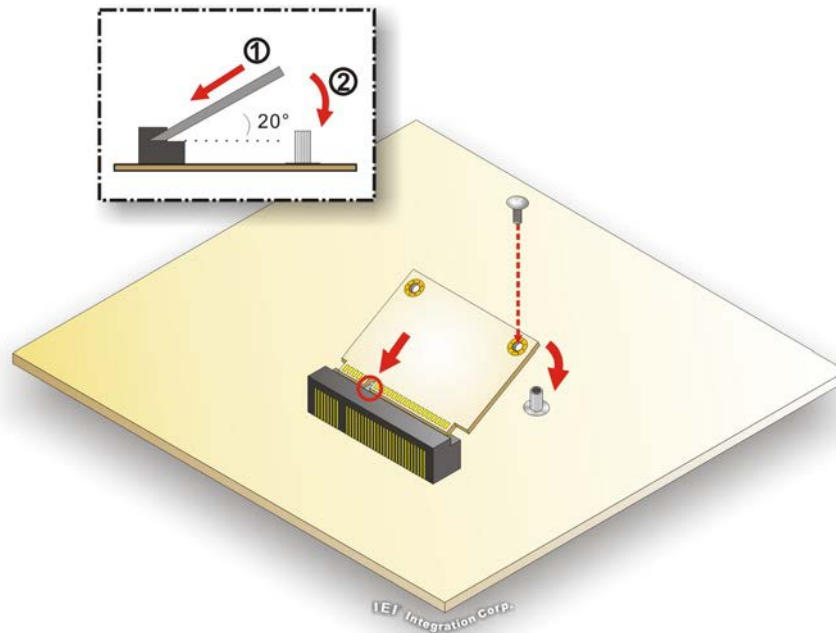

**Figure 4-6: Inserting the mSATA Module into the Slot at an Angle**

## 4.6 System Configuration

The system configuration is controlled by buttons, jumpers and switches. The system configuration should be performed before installation.

### 4.6.1 AT/ATX Mode Select Switch

<b>CN Label:</b>	<b>J_ATX_AT1</b>
<b>CN Type:</b>	Switch
<b>CN Location:</b>	See <b>Figure 4-7</b>
<b>CN Settings:</b>	See <b>Table 4-1</b>

The AT/ATX mode select switch specifies the systems power mode as AT or ATX. AT/ATX mode select switch settings are shown in **Table 4-1**.



**WAFER-BT-E38xx1W2**

Setting	Description
Short A-B	AT Mode
Short B-C	ATX Mode (Default)

**Table 4-1: AT/ATX Mode Select Switch Settings**

The location of the AT/ATX mode select switch is shown in **Figure 4-7** below.

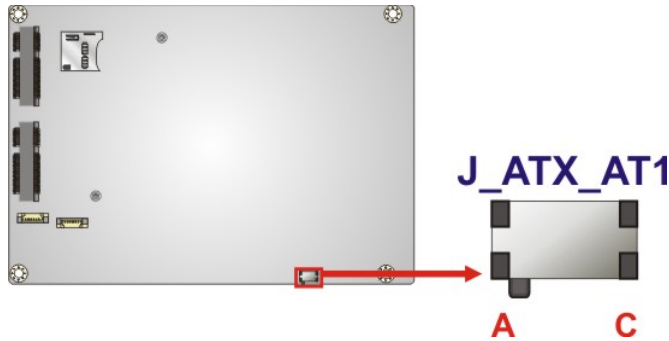

**Figure 4-7: AT/ATX Mode Select Switch Location**

**4.6.2 Clear CMOS Button**

- CN Label:** J\_CMOS1
- CN Type:** Button
- CN Location:** See **Figure 4-8**
- CN Settings:** See **Table 4-2**

If the WAFER-BT-E38xx1W2 fails to boot due to improper BIOS settings, use the button to clear the CMOS data and reset the system BIOS information.

The clear CMOS button settings are shown in **Table 4-2**.

Setting	Description
Open	Normal Operation (Default)
Push	Clear CMOS Setup

**Table 4-2: Clear CMOS Button Settings**

The location of the clear CMOS button is shown in **Figure 4-8**

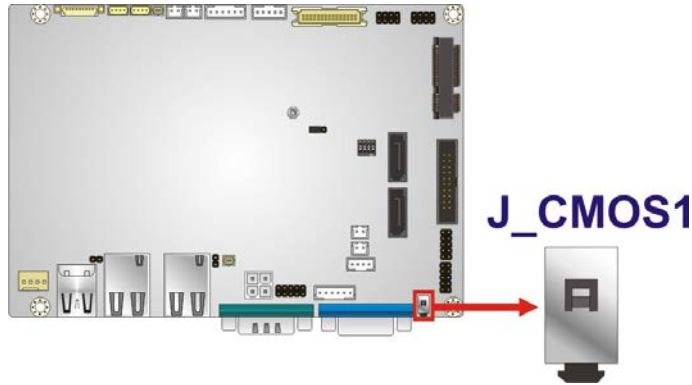

**Figure 4-8: Clear CMOS Button Location**

### 4.6.3 LVDS Panel Resolution Selection

- Jumper Label:** SW1
- Jumper Type:** DIP switch
- Jumper Settings:** See Table 4-3
- Jumper Location:** See Figure 4-9

Selects the resolution of the LCD panel connected to the LVDS connector.

\* ON=0, OFF=1; Single=S, Dual=D

SW1 (4-3-2-1)	Description
0000	800x600 18-bit S (default)
0001	1024x768 18-bit S
0010	1024x768 24-bit S
0011	1280x768 18-bit S
0100	1280x800 18-bit S
0101	1280x960 18-bit S
0110	1280x1024 24-bit D
0111	1366x768 18-bit S
1000	1366x768 24-bit S
1001	1440x960 24-bit D
1010	1400x1050 24-bit D
1011	1600x900 24-bit D

WAFER-BT-E38xx1W2

SW1 (4-3-2-1)	Description
1100	1680x1050 24-bit D
1101	1600x1200 24-bit D
1110	1920x1080 24-bit D
1111	1920x1200 24-bit D

Table 4-3: LVDS Panel Resolution Selection

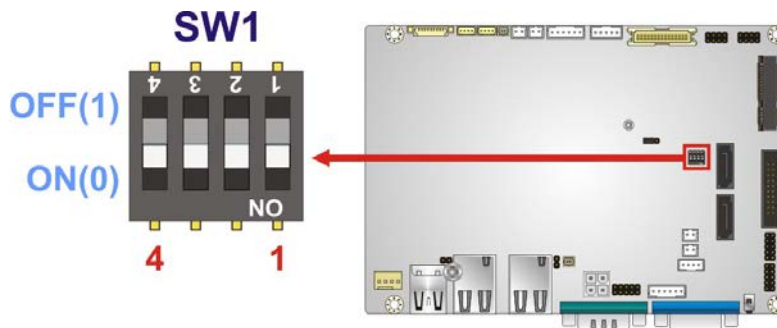

Figure 4-9: LVDS Panel Resolution Selection Switch Location

4.6.4 LVDS Voltage Selection



**WARNING:**

Permanent damage to the screen and WAFER-BT-E38xx1W2 may occur if the wrong voltage is selected with this jumper. Please refer to the user guide that came with the monitor to select the correct voltage.

- Jumper Label:** JP3
- Jumper Type:** 3-pin header, p=2.0 mm
- Jumper Settings:** See Table 4-4
- Jumper Location:** See Figure 4-10

The LVDS voltage selection jumper allows setting the voltage provided to the monitor connected to the LVDS connector.

Setting	Description
Short 1-2	+3.3V (Default)
Short 2-3	+5V

**Table 4-4: LVDS Voltage Selection Jumper Settings**

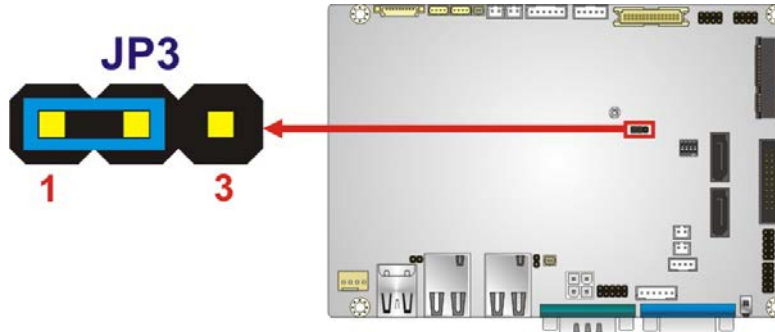

**Figure 4-10: LVDS Voltage Selection Jumper Location**

## 4.7 Chassis Installation

### 4.7.1 Heat Sink



**WARNING:**

Never run the WAFER-BT-E38xx1W2 without the heat sink secured to the board. The heat sink ensures the system remains cool and does not need addition heat sinks to cool the system.

## WAFER-BT-E38xx1W2

---



### **WARNING:**

When running the WAFER-BT-E38xx1W2, do not put the WAFER-BT-E38xx1W2 directly on a surface that can not dissipate system heat, especially the wooden or plastic surface. It is highly recommended to run the WAFER-BT-E38xx1W2

→ on a heat dissipation surface or

→ using copper pillars to hold the board up from the chassis

---

When the WAFER-BT-E38xx1W2 is shipped, a heat sink is secured to the board with four retention screws. If the WAFER-BT-E38xx1W2 must be removed from the heat sink, the four retention screws must be removed.

### **4.7.2 Motherboard Installation**

To install the WAFER-BT-E38xx1W2 motherboard into the chassis please refer to the reference material that came with the chassis.

## **4.8 Internal Peripheral Device Connections**

This section outlines the installation of peripheral devices to the on-board connectors

### **4.8.1 AT Power Connection**

Follow the instructions below to connect the WAFER-BT-E38xx1W2 to an AT power supply.

---



### **WARNING:**

Disconnect the power supply power cord from its AC power source to prevent a sudden power surge to the WAFER-BT-E38xx1W2.

---

**Step 1:** **Locate the power cable.** The power cable is shown in the packing list in Chapter 3.

**Step 2:** **Connect the Power Cable to the Motherboard.** Connect the 4-pin (2x2) Molex type power cable connector to the AT power connector on the motherboard. See Figure 4-11.

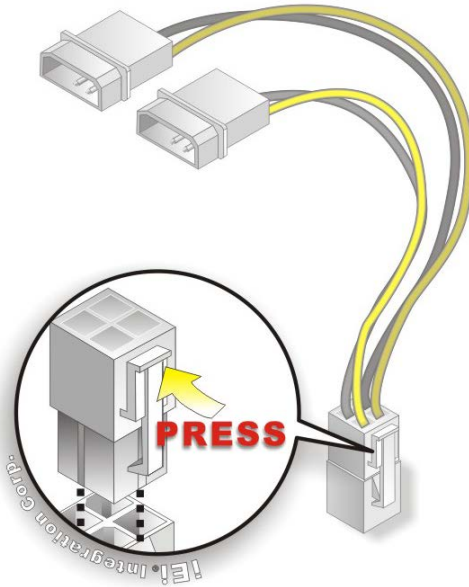

**Figure 4-11: Power Cable to Motherboard Connection**

**Step 3:** **Connect Power Cable to Power Supply.** Connect one of the 4-pin (1x4) Molex type power cable connectors to an AT power supply. See Figure 4-12.

## WAFER-BT-E38xx1W2

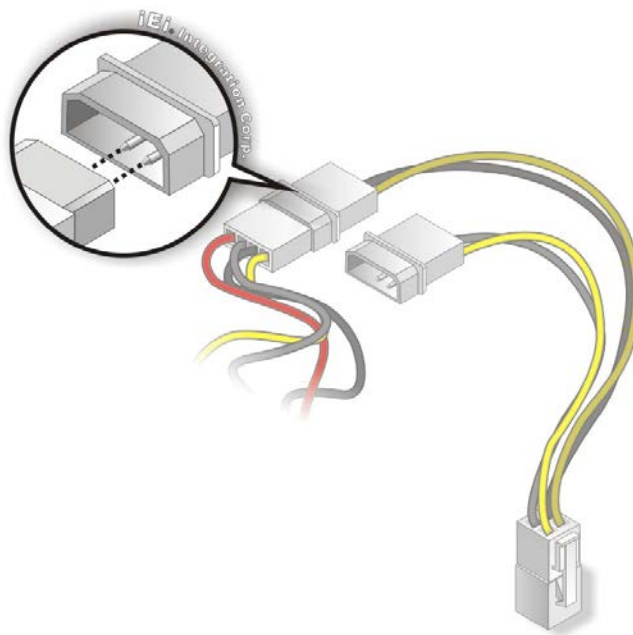
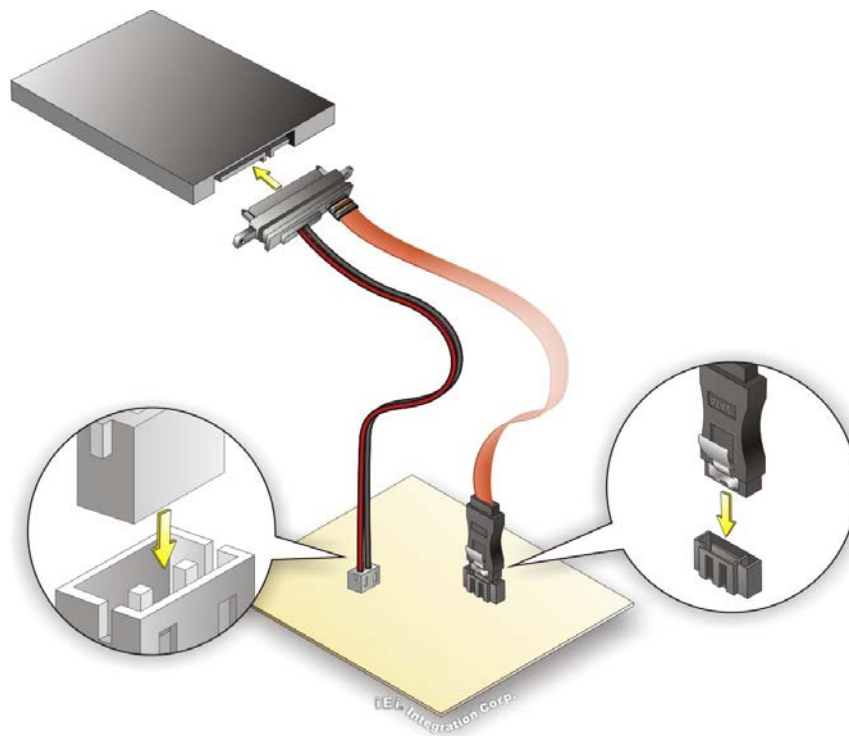

Figure 4-12: Connect Power Cable to Power Supply

#### 4.8.2 SATA Drive Connection

The WAFER-BT-E38xx1W2 is shipped with a SATA drive cable. To connect the SATA drive to the connector, please follow the steps below.

- Step 1:** Locate the **SATA connector** and the **SATA power connector**. The locations of the connectors are shown in **Chapter 3**.
- Step 2:** **Insert the cable connector**. Insert the cable connector into the on-board SATA drive connector and the SATA power connector. See **Figure 4-13**.



**Figure 4-13: SATA Drive Cable Connection**

- Step 3:** Connect the cable to the SATA disk. Connect the connector on the other end of the cable to the connector at the back of the SATA drive. See **Figure 4-13**.
- Step 4:** To remove the SATA cable from the SATA connector, press the clip on the connector at the end of the cable.



Chapter

5

# BIOS

---

## 5.1 Introduction

The BIOS is programmed onto the BIOS chip. The BIOS setup program allows changes to certain system settings. This chapter outlines the options that can be changed.



### NOTE:

Some of the BIOS options may vary throughout the life cycle of the product and are subject to change without prior notice.

---

### 5.1.1 Starting Setup

The UEFI BIOS is activated when the computer is turned on. The setup program can be activated in one of two ways.

1. Press the **DELETE** or **F2** key as soon as the system is turned on or
2. Press the **DELETE** or **F2** key when the “**Press Del to enter SETUP**” message appears on the screen.

If the message disappears before the **DELETE** or **F2** key is pressed, restart the computer and try again.

### 5.1.2 Using Setup

Use the arrow keys to highlight items, press **ENTER** to select, use the PageUp and PageDown keys to change entries, press **F1** for help and press **ESC** to quit. Navigation keys are shown in.

Key	Function
Up arrow	Move to previous item
Down arrow	Move to next item
Left arrow	Move to the item on the left hand side
Right arrow	Move to the item on the right hand side
+	Increase the numeric value or make changes

## WAFER-BT-E38xx1W2

Key	Function
-	Decrease the numeric value or make changes
F1 key	General help, only for Status Page Setup Menu and Option Page Setup Menu
F2 key	Load previous values.
F3 key	Load optimized defaults
F4 key	Save changes and Exit BIOS
Esc key	Main Menu – Quit and not save changes into CMOS Status Page Setup Menu and Option Page Setup Menu -- Exit current page and return to Main Menu

**Table 5-1: BIOS Navigation Keys**

### 5.1.3 Getting Help

When **F1** is pressed a small help window describing the appropriate keys to use and the possible selections for the highlighted item appears. To exit the Help Window press **Esc** or the **F1** key again.

### 5.1.4 Unable to Reboot after Configuration Changes

If the computer cannot boot after changes to the system configuration is made, CMOS defaults. Use the jumper described in Chapter 3.

### 5.1.5 BIOS Menu Bar

The **menu bar** on top of the BIOS screen has the following main items:

- Main – Changes the basic system configuration.
- Advanced – Changes the advanced system settings.
- Chipset – Changes the chipset settings.
- Security – Sets User and Supervisor Passwords.
- Boot – Changes the system boot configuration.
- Save & Exit – Selects exit options and loads default settings

The following sections completely describe the configuration options found in the menu items at the top of the BIOS screen and listed above.

## 5.2 Main

The **Main** BIOS menu (**BIOS Menu 1**) appears when the **BIOS Setup** program is entered. The **Main** menu gives an overview of the basic system information.

Aptio Setup Utility - Copyright (C) 2013 American Megatrends, Inc.		
Main	Advanced	Chipset Security Boot Save & Exit
BIOS Information		Set the Date. Use Tab to switch between Data elements.
BIOS Vendor	American Megatrends	
Core Version	5.009	
Compliancy	UEFI 2.3; PI 1.2	
Project Version	SAD3AR11.ROM	
Build Date and Time	10/28/2015 15:21:56	
iWDD Vendor	iEi	
iWDD Version	SAD3ER10.bin	
Memory Information		
Total Memory	2048 MB(LPDDR3)	
TXE Information		-----
Sec RC Version	00.05.00.00	←→: Select Screen
TXE FW Version	01.00.02.1060	↑ ↓: Select Item
System Date	[Fri 01/01/2010]	EnterSelect
System Time	[00:18:35]	+/-: Change Opt.
Access Level	Administrator	F1: General Help
		F2: Previous Values
		F3: Optimized Defaults
		F4: Save & Exit
		ESC: Exit
Version 2.16.1242. Copyright (C) 2013 American Megatrends, Inc.		

### BIOS Menu 1: Main

The Main menu lists the following system details:

- BIOS Information
- iWDD Information
- Memory Information
- TXE Information

The System Overview field also has two user configurable fields:

## WAFER-BT-E38xx1W2

### → System Date [xx/xx/xx]

Use the **System Date** option to set the system date. Manually enter the day, month and year.

### → System Time [xx:xx:xx]

Use the **System Time** option to set the system time. Manually enter the hours, minutes and seconds.

## 5.3 Advanced

Use the **Advanced** menu (**BIOS Menu 2**) to configure the CPU and peripheral devices through the following sub-menus:



### WARNING!

Setting the wrong values in the sections below may cause the system to malfunction. Make sure that the settings made are compatible with the hardware.

```

Aptio Setup Utility - Copyright (C) 2013 American Megatrends, Inc.
Main  Advanced  Chipset  Security  Boot  Save & Exit
-----
> ACPI Settings
> Super IO Configuration
> Hardware Monitor
> RTC Wake Settings
> Serial Port Console Redirection
> iEi Feature
> CPU Configuration
> IDE Configuration
> USB Configuration

System ACPI Parameters.
-----
<=>: Select Screen
↑ ↓: Select Item
Enter>Select
F1  General Help
F2  Previous Values
F3  Optimized Defaults
F4  Save
ESC Exit

Version 2.16.1242. Copyright (C) 2013 American Megatrends, Inc.
    
```

### BIOS Menu 2: Advanced

### 5.3.1 ACPI Settings

The **ACPI Settings** menu (**BIOS Menu 3**) configures the Advanced Configuration and Power Interface (ACPI) options.

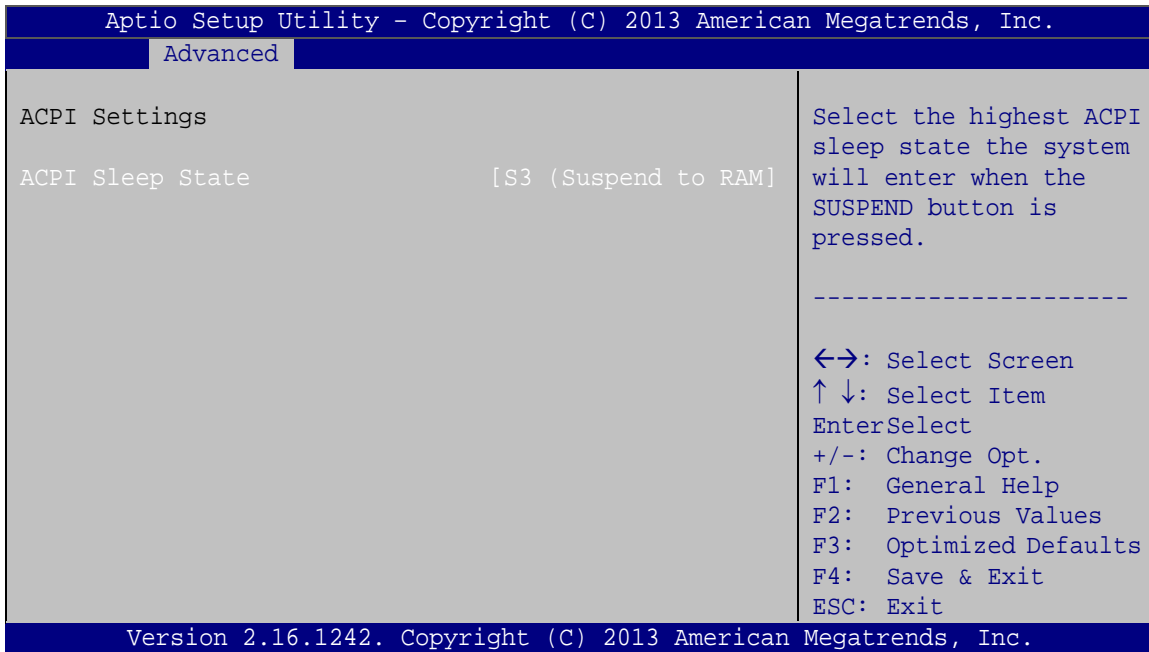

#### BIOS Menu 3: ACPI Configuration

##### → **ACPI Sleep State [S3 only (Suspend to RAM)]**

The fields in **ACPI Sleep State** option cannot be changed.

- **Suspend Disabled**                      Disable the suspend function.
- **S3 (Suspend to DEFAULT RAM)**      The caches are flushed and the CPU is powered off. Power to the RAM is maintained. The computer returns slower to a working state, but more power is saved.

## WAFER-BT-E38xx1W2

### 5.3.2 Super IO Configuration

Use the **Super IO Configuration** menu (**BIOS Menu 4**) to set or change the configurations for the serial ports.

```

Aptio Setup Utility - Copyright (C) 2013 American Megatrends, Inc.
  Advanced
Super IO Configuration
Super IO Chip                F81866
> Serial Port 1 Configuration
> Serial Port 2 Configuration
> Serial Port 3 Configuration

Set Parameters of Serial
Port 1 (COMA)
-----
<-->: Select Screen
↑ ↓: Select Item
EnterSelect
F1   General Help
F2   Previous Values
F3   Optimized
Defaults
F4   Save
ESC  Exit

Version 2.16.1242. Copyright (C) 2013 American Megatrends, Inc.
  
```

**BIOS Menu 4: Super IO Configuration**

#### 5.3.2.1 Serial Port n Configuration

Use the **Serial Port n Configuration** menu (**BIOS Menu 5**) to configure the serial port n.

```

Aptio Setup Utility - Copyright (C) 2013 American Megatrends, Inc.
  Advanced
F81216 Serial Port 1 Configuration
Serial Port                [Enabled]
Device Settings            IO=3F8h; IRQ=4
Change Settings            [Auto]

Enable or Disable Serial
Port (COM)
-----
<-->: Select Screen
↑ ↓: Select Item
EnterSelect
F1   General Help
F2   Previous Values
F3   Optimized
Defaults
F4   Save
ESC  Exit

Version 2.16.1242. Copyright (C) 2013 American Megatrends, Inc.
  
```

**BIOS Menu 5: Serial Port n Configuration Menu**

### 5.3.2.1.1 Serial Port 1 Configuration

→ **Serial Port [Enabled]**

Use the **Serial Port** option to enable or disable the serial port.

- **Disabled**                                      Disable the serial port
- **Enabled      DEFAULT**                      Enable the serial port

→ **Change Settings [Auto]**

Use the **Change Settings** option to change the serial port IO port address and interrupt address.

- **Auto                                      DEFAULT**                      The serial port IO port address and interrupt address are automatically detected.
- **IO=3F8h; IRQ=4**                                      Serial Port I/O port address is 3F8h and the interrupt address is IRQ4
- **IO=3F8h; IRQ=3, 4,5,6,7,9,10,11,12**                                      Serial Port I/O port address is 3F8h and the interrupt address is IRQ3,4,5,6,7,9,10,11,12
- **IO=2F8h; IRQ=3, 4,5,6,7,9,10,11,12**                                      Serial Port I/O port address is 2F8h and the interrupt address is IRQ3,4,5,6,7,9,10,11,12
- **IO=3E8h; IRQ=3, 4,5,6,7,9,10,11,12**                                      Serial Port I/O port address is 3E8h and the interrupt address is IRQ3,4,5,6,7,9,10,11,12
- **IO=2E8h; IRQ=3, 4,5,6,7,9,10,11,12**                                      Serial Port I/O port address is 2E8h and the interrupt address is IRQ3,4,5,6,7,9,10,11,12



## WAFER-BT-E38xx1W2

### 5.3.2.1.2 Serial Port 2 Configuration

#### → Serial Port [Enabled]

Use the **Serial Port** option to enable or disable the serial port.

- **Disabled**                      Disable the serial port
- **Enabled**      **DEFAULT**      Enable the serial port

#### → Change Settings [Auto]

Use the **Change Settings** option to change the serial port IO port address and interrupt address.

- **Auto**                      **DEFAULT**              The serial port IO port address and interrupt address are automatically detected.
- **IO=2F8h; IRQ=3**                      Serial Port I/O port address is 2F8h and the interrupt address is IRQ3
- **IO=3F8h; IRQ=3, 4,5,6,7,9,10,11,12**                      Serial Port I/O port address is 3F8h and the interrupt address is IRQ3,4,5,6,7,9,10,11,12
- **IO=2F8h; IRQ=3, 4,5,6,7,9,10,11,12**                      Serial Port I/O port address is 2F8h and the interrupt address is IRQ3,4,5,6,7,9,10,11,12
- **IO=3E8h; IRQ=3, 4,5,6,7,9,10,11,12**                      Serial Port I/O port address is 3E8h and the interrupt address is IRQ3,4,5,6,7,9,10,11,12
- **IO=2E8h; IRQ=3, 4,5,6,7,9,10,11,12**                      Serial Port I/O port address is 2E8h and the interrupt address is IRQ3,4,5,6,7,9,10,11,12

### 5.3.2.1.3 Serial Port 3 Configuration

➔ **Serial Port [Enabled]**

Use the **Serial Port** option to enable or disable the serial port.

- ➔ **Disabled**                      Disable the serial port
- ➔ **Enabled      DEFAULT**      Enable the serial port

➔ **Change Settings [Auto]**

Use the **Change Settings** option to change the serial port IO port address and interrupt address.

- ➔ **Auto                      DEFAULT**      The serial port IO port address and interrupt address are automatically detected.
- ➔ **IO=3E8h; IRQ=7**                      Serial Port I/O port address is 3E8h and the interrupt address is IRQ7
- ➔ **IO=3F8h; IRQ=3, 4,5,6,7,9,10,11,12**                      Serial Port I/O port address is 3F8h and the interrupt address is IRQ3,4,5,6,7,9,10,11,12
- ➔ **IO=2F8h; IRQ=3, 4,5,6,7,9,10,11,12**                      Serial Port I/O port address is 2F8h and the interrupt address is IRQ3,4,5,6,7,9,10,11,12
- ➔ **IO=3E8h; IRQ=3, 4,5,6,7,9,10,11,12**                      Serial Port I/O port address is 3E8h and the interrupt address is IRQ3,4,5,6,7,9,10,11,12
- ➔ **IO=2E8h; IRQ=3, 4,5,6,7,9,10,11,12**                      Serial Port I/O port address is 2E8h and the interrupt address is IRQ3,4,5,6,7,9,10,11,12
- ➔ **IO=2F0h; IRQ=3, 4,5,6,7,9,10,11,12**                      Serial Port I/O port address is 2F0h and the interrupt address is IRQ3,4,5,6,7,9,10,11,12
- ➔ **IO=2E0h; IRQ=3, 4,5,6,7,9,10,11,12**                      Serial Port I/O port address is 2E0h and the interrupt address is IRQ3,4,5,6,7,9,10,11,12

## WAFER-BT-E38xx1W2

### 5.3.3 Hardware Monitor

The Hardware Monitor menu (**BIOS Menu 6**) contains the fan configuration submenus and displays operating temperature, fan speeds and system voltages.

```

Aptio Setup Utility - Copyright (C) 2013 American Megatrends, Inc.
Advanced
PC Health Status
> Smart Fan Function
CPU temperature           :+55 C
System temperature       :+37 C
CPU Fan Speed            :N/A
Enable or Disable Smart Fan
-----
<->: Select Screen
↑ ↓: Select Item
EnterSelect
+ - Change Opt.
F1  General Help
F2  Previous Values
F3  Optimized Defaults
F4  Save & Exit
ESC Exit
Version 2.16.1242. Copyright (C) 2013 American Megatrends, Inc.

```

#### BIOS Menu 6: Hardware Monitor

##### → PC Health Status

The following system parameters and values are shown. The system parameters that are monitored are:

- System Temperatures:
  - CPU Temperature
  - System temperature
- Fan Speed:
  - CPU Fan Speed

### 5.3.3.1 Smart Fan Mode Configuration

Use the **Smart Fan Mode Configuration submenu (BIOS Menu 7)** to configure fan temperature and speed settings.

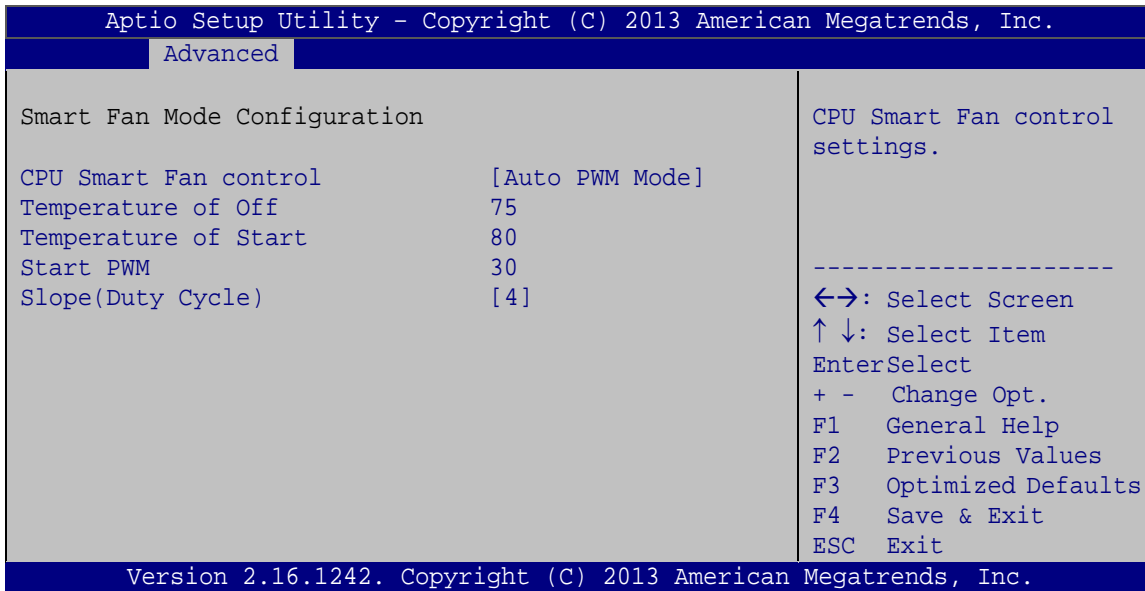

#### BIOS Menu 7: Smart Fan Mode Configuration

##### → CPU Smart Fan control [Auto PWM Mode]

Use the **CPU Smart Fan control** BIOS option to configure the CPU Smart Fan.

- **Manual PWM Mode**                      The fan spins at the speed set in the manual PWM setting
- **Auto PWM Mode**                      **DEFAULT**      The fan adjusts its speed using these settings:
  - Temperature of Off
  - Temperature of Start
  - Start PWM
  - Slope (Duty Cycle)

## WAFER-BT-E38xx1W2

## → Temperature of Off [75]

**WARNING:**

Setting this value too high may cause the fan to speed up only when the CPU is at a very high temperature and therefore cause the system to be damaged.

The **Temperature of Off** option can only be set if the **CPU Smart Fan control** option is set to **Auto Mode**. If the CPU temperature is lower than **Temperature of Off**, the fan speed change to be lowest. To set a value, select the **Temperature of Off** option and enter a decimal number between 0 and 127. The temperature range is specified below.

- Minimum Value: 0°C
- Maximum Value: 127°C

## → Temperature of Start [80]

**WARNING:**

Setting this value too high may cause the fan to rotate at full speed only when the CPU is at a very high temperature and therefore cause the system to be damaged.

The **Temperature of Start** option can only be set if the **CPU Smart Fan control** option is set to **Auto Mode**. If the CPU temperature is between **Temperature of Off** and **Temperature of Start**, the fan speed change to be **Start PWM**. To set a value, select the **Temperature of Start** option and enter a decimal number between 0 and 127. The temperature range is specified below.

- Minimum Value: 0°C
- Maximum Value: 127°C

**→ Start PWM [30]**

The **Start PWM** option can only be set if the **CPU Smart Fan control** option is set to **Auto Mode**. Use the **Start PWM** option to set the PWM start value. To set a value, select the **Start PWM** option and enter a decimal number between 0 and 100. The temperature range is specified below.

- Minimum Value: 0
- Maximum Value: 100

**→ Slope (Duty Cycle) [4]**

The **Slope (Duty Cycle)** option can only be set if the **CPU Smart Fan control** option is set to **Auto Mode**. Use the **Slope (Duty Cycle)** option to select the linear rate at which the PWM mode increases with respect to an increase in temperature. A list of available options is shown below:

- 0
- 1
- 2
- 4
- 8
- 16

## WAFER-BT-E38xx1W2

### 5.3.4 RTC Wake Settings

The **RTC Wake Settings** menu (**BIOS Menu 8**) configures RTC wake event.

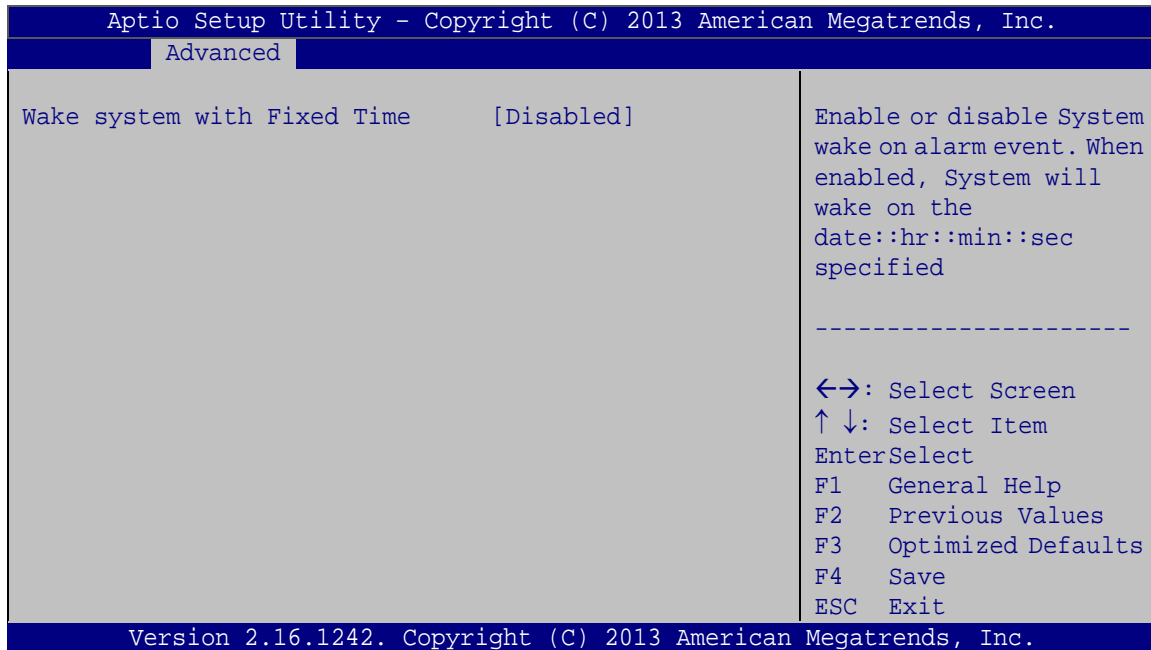

#### BIOS Menu 8: RTC Wake Settings

##### → Wake system with Fixed Time [Disabled]

Use the **Wake system with Fixed Time** option to enable or disable the system wake on alarm event.

- **Disabled**      **DEFAULT**      The real time clock (RTC) cannot generate a wake event
  
- **Enabled**      If selected, the **Wake up every day** option appears allowing you to enable to disable the system to wake every day at the specified time. Besides, the following options appear with values that can be selected:
  - Wake up date
  - Wake up hour
  - Wake up minute

Wake up second

After setting the alarm, the computer turns itself on from a suspend state when the alarm goes off.

### 5.3.5 Serial Port Console Redirection

The **Serial Port Console Redirection** menu (**BIOS Menu 9**) allows the console redirection options to be configured. Console redirection allows users to maintain a system remotely by re-directing keyboard input and text output through the serial port.

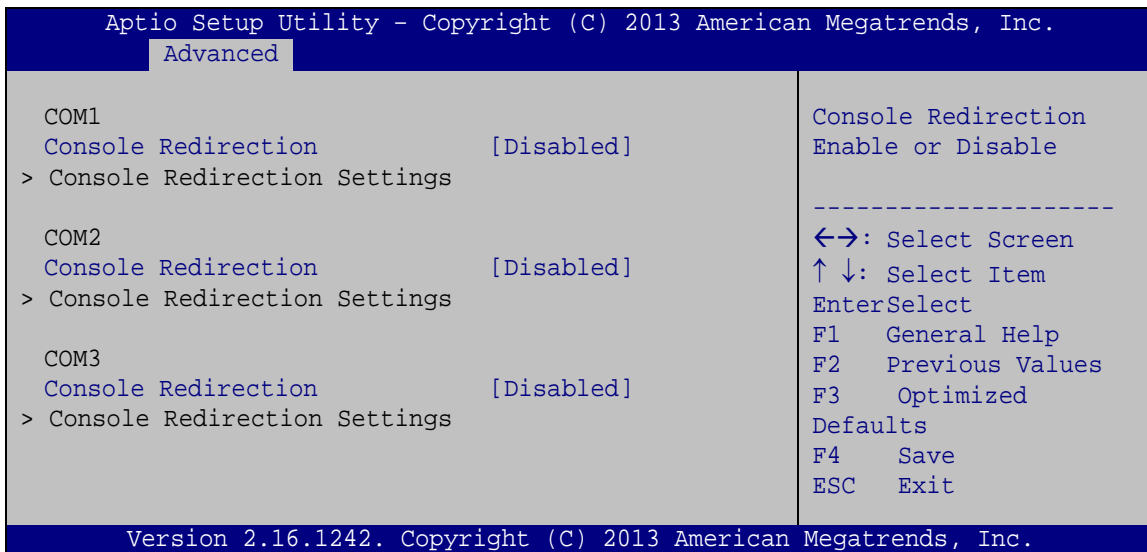

#### BIOS Menu 9: Serial Port Console Redirection

##### ➔ Console Redirection [Disabled]

Use **Console Redirection** option to enable or disable the console redirection function.

- ➔ **Disabled**    **DEFAULT**    Disabled the console redirection function
- ➔ **Enabled**                    Enabled the console redirection function



## WAFER-BT-E38xx1W2

### 5.3.5.1 Console Redirection Settings

The **Console Redirection Settings** menu (**BIOS Menu 10**) allows the console redirection options to be configured. The option is active when Console Redirection option is enabled.

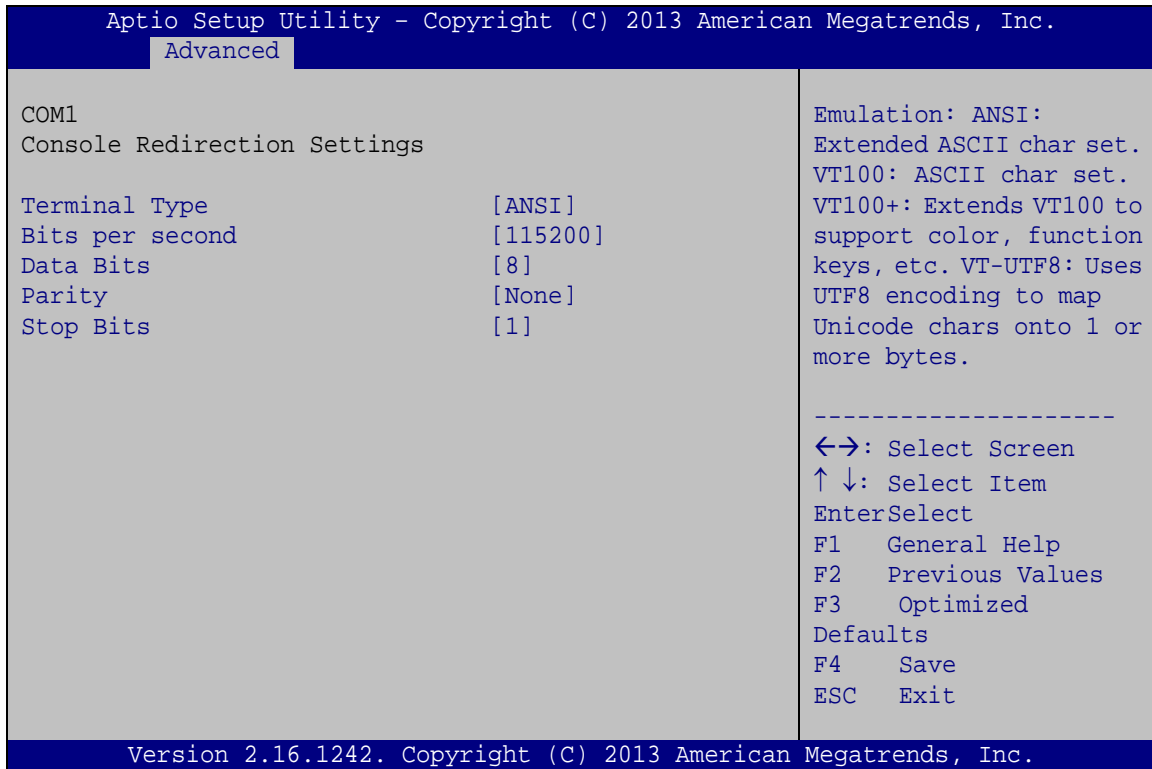

#### BIOS Menu 10: Console Redirection Settings

##### → Terminal Type [ANSI]

Use the **Terminal Type** option to specify the remote terminal type.

- **VT100**                                      The target terminal type is VT100
- **VT100+**                                    The target terminal type is VT100+
- **VT-UTF8**                                    The target terminal type is VT-UTF8
- **ANSI**                                        **DEFAULT**                                    The target terminal type is ANSI

**→ Bits per second [115200]**

Use the **Bits per second** option to specify the serial port transmission speed. The speed must match the other side. Long or noisy lines may require lower speeds.

- |                 |                |  |
|-----------------|----------------|--|
| <b>→ 9600</b>   |                | Sets the serial port transmission speed at 9600.   |
| <b>→ 19200</b>  |                | Sets the serial port transmission speed at 19200.  |
| <b>→ 38400</b>  |                | Sets the serial port transmission speed at 38400.  |
| <b>→ 57600</b>  |                | Sets the serial port transmission speed at 57600.  |
| <b>→ 115200</b> | <b>DEFAULT</b> | Sets the serial port transmission speed at 115200. |

**→ Data Bits [8]**

Use the **Data Bits** option to specify the number of data bits.

- |            |                |                          |
|------------|----------------|--------------------------|
| <b>→ 7</b> |                | Sets the data bits at 7. |
| <b>→ 8</b> | <b>DEFAULT</b> | Sets the data bits at 8. |

**→ Parity [None]**

Use the **Parity** option to specify the parity bit that can be sent with the data bits for detecting the transmission errors.

- |                |                |   |
|----------------|----------------|---|
| <b>→ None</b>  | <b>DEFAULT</b> | No parity bit is sent with the data bits.                                 |
| <b>→ Even</b>  |                | The parity bit is 0 if the number of ones in the data bits is even.       |
| <b>→ Odd</b>   |                | The parity bit is 0 if the number of ones in the data bits is odd.        |
| <b>→ Mark</b>  |                | The parity bit is always 1. This option does not provide error detection. |
| <b>→ Space</b> |                | The parity bit is always 0. This option does not provide error detection. |

## WAFER-BT-E38xx1W2

### → Stop Bits [1]

Use the **Stop Bits** option to specify the number of stop bits used to indicate the end of a serial data packet. Communication with slow devices may require more than 1 stop bit.

- **1**            **DEFAULT**      Sets the number of stop bits at 1.
- **2**                              Sets the number of stop bits at 2.

### 5.3.6 IEI Feature

Use the **IEI Feature** menu (**BIOS Menu 11**) to configure One Key Recovery function.

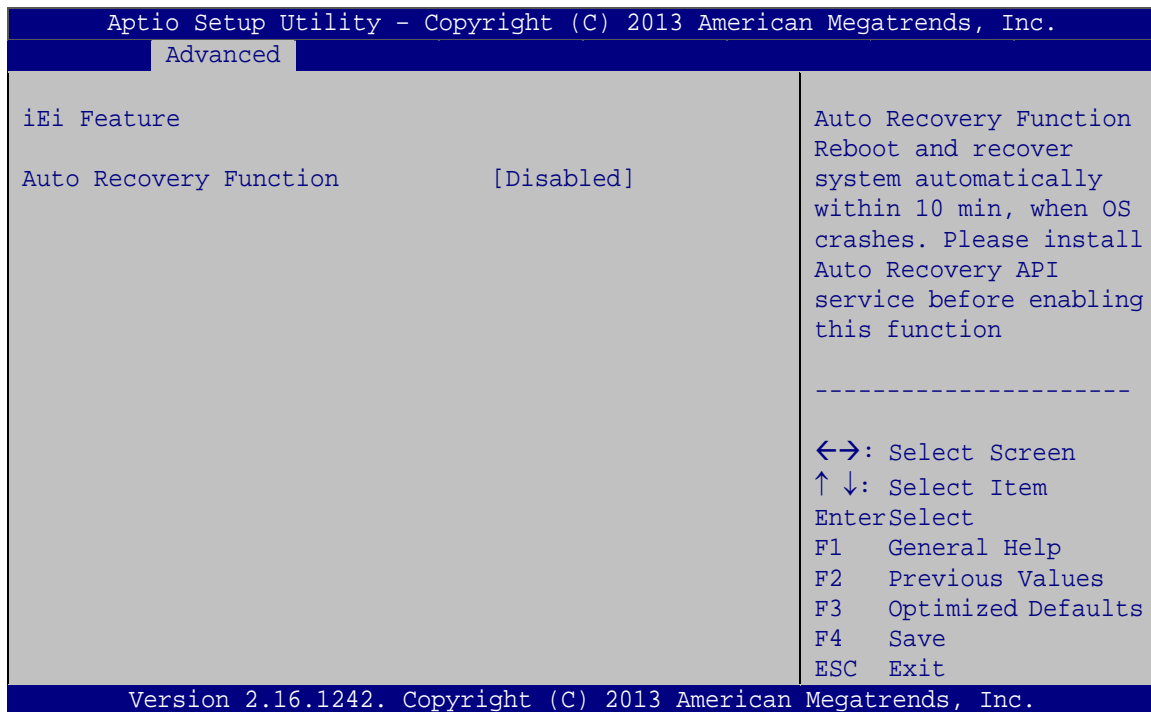

#### BIOS Menu 11: IEI Feature

### → Auto Recovery Function [Disabled]

Use the **Auto Recovery Function** BIOS option to enable or disable the auto recovery function of the IEI One Key Recovery.

- **Disabled**    **DEFAULT**      Auto recovery function disabled
- **Enabled**                      Auto recovery function enabled

### 5.3.7 CPU Configuration

Use the **CPU Configuration** menu (**BIOS Menu 12**) to view detailed CPU specifications and configure the CPU.

```

Aprio Setup Utility - Copyright (C) 2013 American Megatrends, Inc.
  Advanced
CPU Configuration
Intel(R) Atom(TM) CPU E3825 @ 1.33GHz
CPU Signature                30679
Microcode Patch              901
Max CPU Speed                1330 MHz
Min CPU Speed                533 MHz
Processor Cores              2
Intel HT Technology          Not Supported
Intel VT-x Technology        Supported

L1 Data Cache                24 KB x 2
L1 Code Cache                32 KB x 2
L2 Cache                     1024 KB x 1
L3 Cache                     Not Present
CPU Speed                    1334 MHz
64-bit                       Supported

Intel Virtualization Technology [Enabled]
EIST                          [Enabled]

When enabled, a VMM can utilize the additional hardware capabilities provided by Vanderpool Technology.

-----
<->: Select Screen
^ v: Select Item
Enter>Select
F1  General Help
F2  Previous Values
F3  Optimized
Defaults
F4  Save
ESC Exit

Version 2.16.1242. Copyright (C) 2013 American Megatrends, Inc.
  
```

#### BIOS Menu 12: CPU Configuration

##### → Intel® Virtualization Technology [Disabled]

Use the **Intel® Virtualization Technology** option to enable or disable virtualization on the system. When combined with third party software, Intel® Virtualization technology allows several OSs to run on the same system at the same time.

- **Disabled**      **DEFAULT**      Disables Intel® Virtualization Technology.
- **Enabled**                      Enables Intel® Virtualization Technology.

##### → EIST [Enabled]

Use the **EIST** option to enable or disable the Intel® Speed Step Technology.

## WAFER-BT-E38xx1W2

- ➔ **Disabled** Disables the Intel® Speed Step Technology.
- ➔ **Enabled** **DEFAULT** Enables the Intel® Speed Step Technology.

### 5.3.8 IDE Configuration

Use the **IDE Configuration** menu (**BIOS Menu 13**) to change and/or set the configuration of the SATA devices installed in the system.

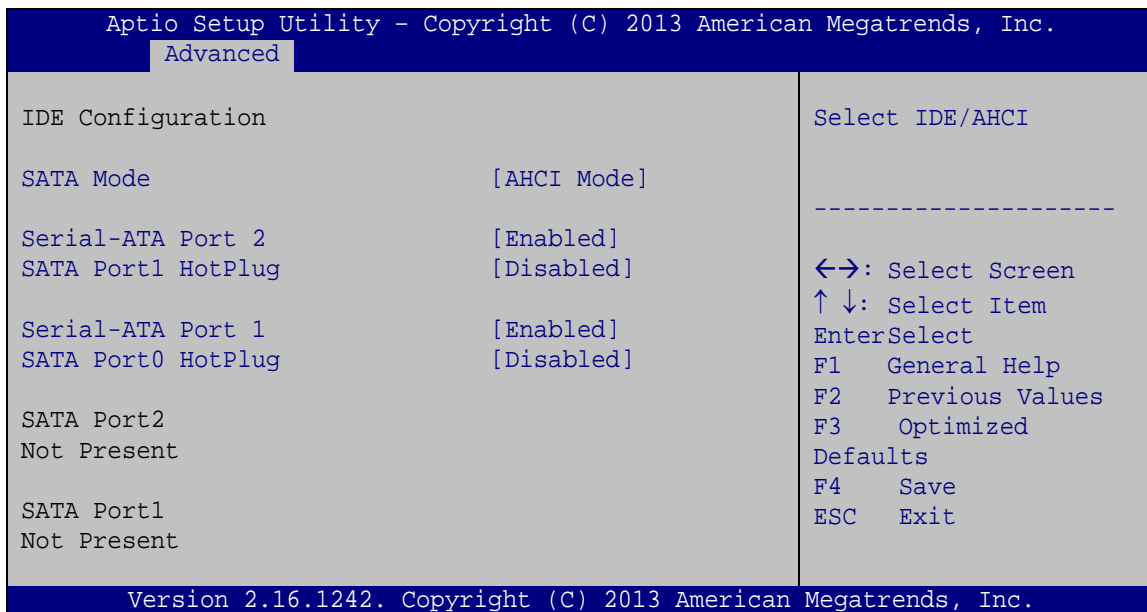

#### BIOS Menu 13: IDE Configuration

##### ➔ **SATA Mode [ACHI Mode]**

Use the **SATA Mode** option to configure SATA devices as normal IDE devices.

- ➔ **IDE Mode** Configures SATA devices as normal IDE device.
- ➔ **ACHI Mode** **DEFAULT** Configures SATA devices as AHCI device.

##### ➔ **Serial-ATA Port 1/2 [Enabled]**

Use the **Serial-ATA Port 1/2** option to enable or disable the SATA device.

- ➔ **Enabled** **DEFAULT** Enables the SATA device.
- ➔ **Disabled** Disables the SATA device.

➔ **SATA Port 1/0 HotPlug [Disabled]**

Use the **Serial-ATA Port 1/0 HotPlug** option to enable or disable the SATA device hot plug.

- ➔ **Enabled**      **DEFAULT**      Enables the SATA device hot plug
- ➔ **Disabled**                      Disables the SATA device hot plug.

**5.3.9 USB Configuration**

Use the **USB Configuration** menu (**BIOS Menu 14**) to read USB configuration information and configure the USB settings.

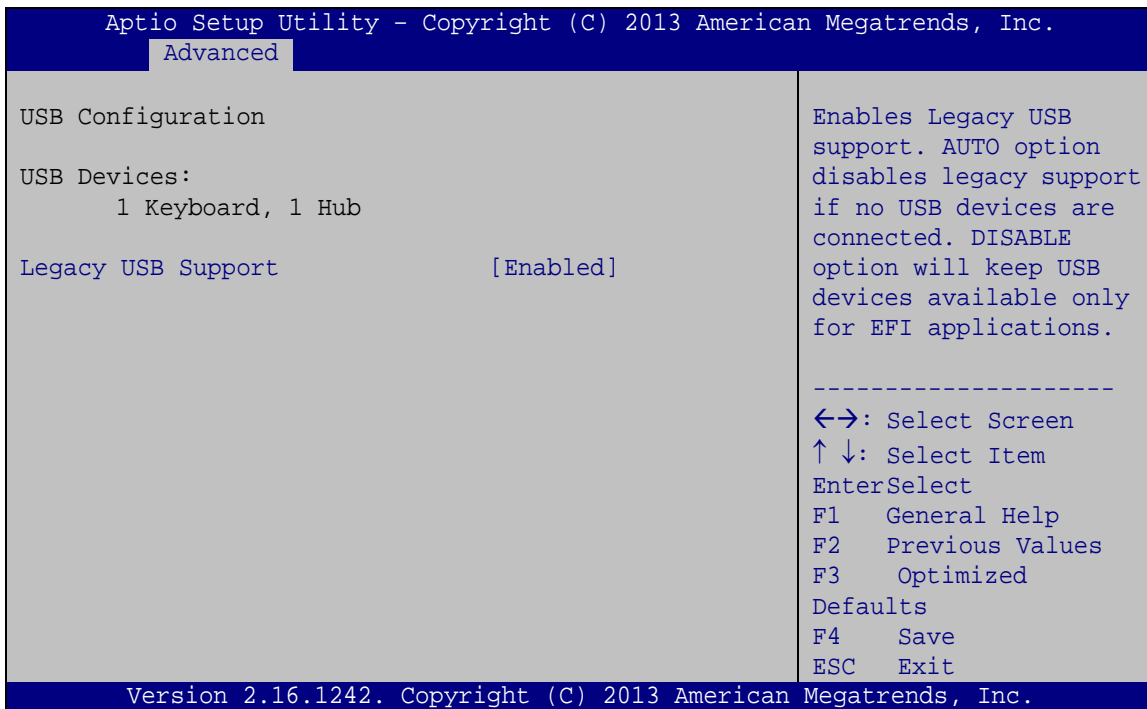

**BIOS Menu 14: USB Configuration**

➔ **USB Devices**

The **USB Devices Enabled** field lists the USB devices that are enabled on the system

## WAFER-BT-E38xx1W2

### → Legacy USB Support [Enabled]

Use the **Legacy USB Support** BIOS option to enable USB mouse and USB keyboard support. Normally if this option is not enabled, any attached USB mouse or USB keyboard does not become available until a USB compatible operating system is fully booted with all USB drivers loaded. When this option is enabled, any attached USB mouse or USB keyboard can control the system even when there is no USB driver loaded onto the system.

- |   |                 |                |   |
|---|-----------------|----------------|---|
| → | <b>Enabled</b>  | <b>DEFAULT</b> | Legacy USB support enabled                                  |
| → | <b>Disabled</b> |                | Legacy USB support disabled                                 |
| → | <b>Auto</b>     |                | Legacy USB support disabled if no USB devices are connected |

## 5.4 Chipset

Use the **Chipset** menu (**BIOS Menu 15**) to access the north bridge and south bridge configuration menus



### **WARNING!**

Setting the wrong values for the Chipset BIOS selections in the Chipset BIOS menu may cause the system to malfunction.

---

```

Aptio Setup Utility - Copyright (C) 2013 American Megatrends, Inc.
Main   Advanced  Chipset   Security  Boot   Save & Exit

> North Bridge
> South Bridge

North Bridge Parameters

-----
<=>: Select Screen
↑ ↓: Select Item
EnterSelect
+/-: Change Opt.
F1   General Help
F2   Previous Values
F3   Optimized Defaults
F4   Save & Exit
ESC  Exit

Version 2.16.1242. Copyright (C) 2013 American Megatrends, Inc.
    
```

**BIOS Menu 15: Chipset**

**5.4.1 North Bridge Configuration**

Use the **North Bridge Configuration** menu (**BIOS Menu 16**) to configure the Intel IGD settings.

```

Aptio Setup Utility - Copyright (C) 2013 American Megatrends, Inc.
                               Chipset
> Intel IGD Configuration

Memory Information
Total Memory           2048 MB(LPDDR3)
Memory Slot0           2048 MB(LPDDR3)
Memory Slot2           Not Present

Configure Intel IGD Settings.

-----
<=>: Select Screen
↑ ↓: Select Item
EnterSelect
+/-: Change Opt.
F1:  General Help
F2:  Previous Values
F3:  Optimized Defaults
F4:  Save & Exit
ESC: Exit

Version 2.16.1242. Copyright (C) 2013 American Megatrends, Inc.
    
```

**BIOS Menu 16: North Bridge Configuration**



## WAFER-BT-E38xx1W2

### → Memory Information

The **Memory Information** lists a brief summary of the on-board memory. The fields in **Memory Information** cannot be changed.

### 5.4.1.1 Intel IGD Configuration

Use the **Intel IGD Configuration** menu (**BIOS Menu 17**) to configure the video device connected to the system.

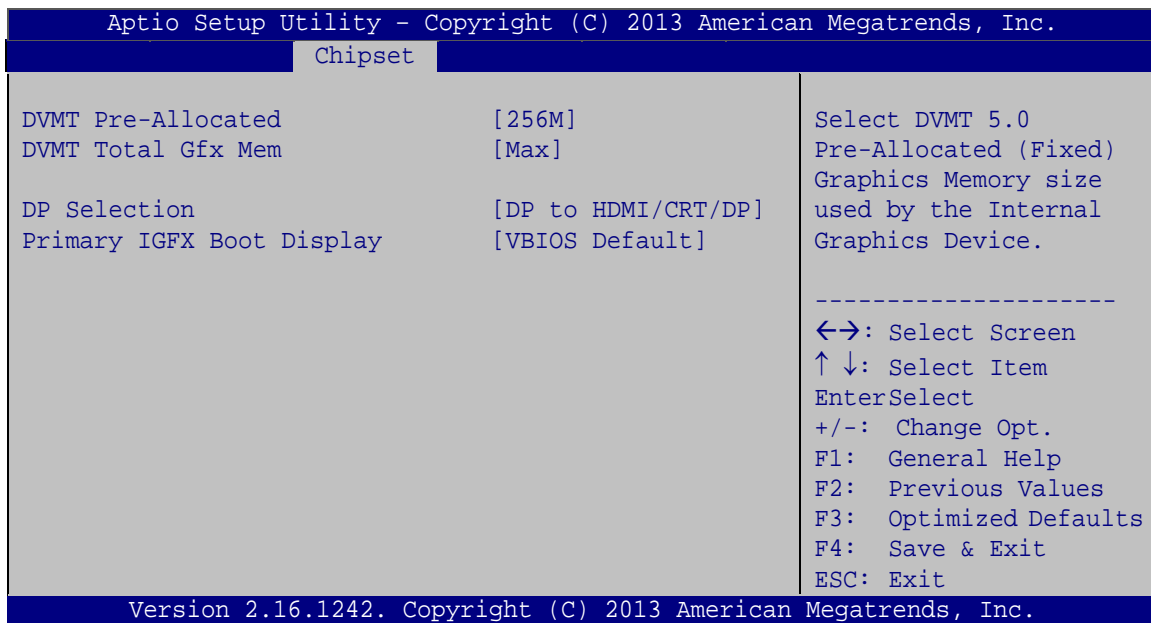

### BIOS Menu 17: Integrated Graphics

### → DVMT Pre-Allocated [256MB]

Use the **DVMT Pre-Allocated** option to set the amount of system memory allocated to the integrated graphics processor when the system boots. The system memory allocated can then only be used as graphics memory, and is no longer available to applications or the operating system. Configuration options are listed below:

- 64M
- 128M
- 256M                      **Default**
- 512M

**→ DVMT Total Gfx Mem [Max]**

Use the **DVMT Total Gfx Mem** option to select DVMT5.0 total graphic memory size used by the internal graphic device. The following options are available:

- 128M
- 256M
- Max **Default**

**→ DP Selection [DP to HDMI/CRT/DP]**

Use the **DP Selection** option to select the display device connected to the internal display port (DP1). Configuration options are listed below.

- DP to LVDS
- DP to HDMI/CRT/DP **DEFAULT**

**→ Primary IGFX Boot Display [VBIOS Default]**

Use the **Primary IGFX Boot Display** option to select the display device used by the system when it boots. For dual display support, select "VBIOS Deafult." Configuration options are listed below.

- VBIOS Default **DEFAULT**
- CRT
- LVDS
- DP Port

## 5.4.2 South Bridge Configuration

Use the **South Bridge Configuration** menu (**BIOS Menu 18**) to configure the south bridge chipset.

## WAFER-BT-E38xx1W2

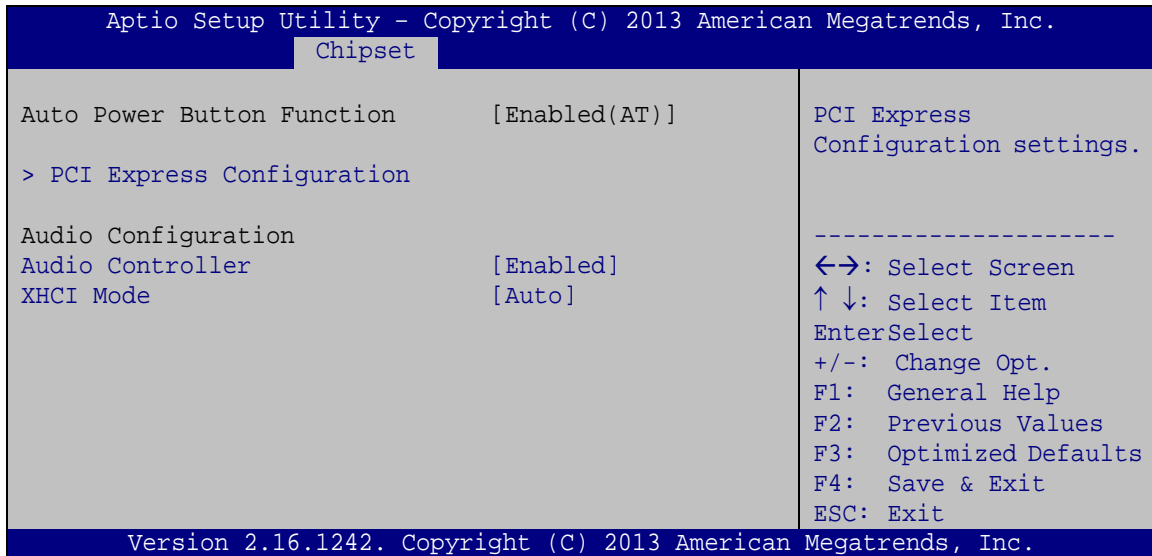

### BIOS Menu 18: South Bridge Configuration

#### → Audio Controller [Enabled]

Use the **Audio Controller** option to enable or disable the High Definition Audio controller.

- **Disabled** The onboard High Definition Audio controller is disabled
- **Enabled** **DEFAULT** The onboard High Definition Audio controller is detected automatically and enabled

#### → XHCI Mode [Auto]

Use the **XHCI Mode** BIOS option to configure the USB xHCI (USB 3.2 Gen 1) controller. If the system is running Windows 7 operating system, the USB 3.2 Gen 1 driver must be installed to support USB 3.2 Gen 1.

- **Enabled** Enable the xHCI controller. USB 3.2 Gen 1 ports behave as USB 3.2 Gen 1 ports.
- **Smart** **DEFAULT** Allow the use of USB 3.2 Gen 1 devices prior to OS boot.  
**Auto** USB 3.2 Gen 1 ports function as USB 3.2 Gen 1 ports even during a reboot.

### 5.4.2.1 PCI Express Configuration

Use the **PCI Express Configuration** menu (**BIOS Menu 19**) to configure the PCI Express.

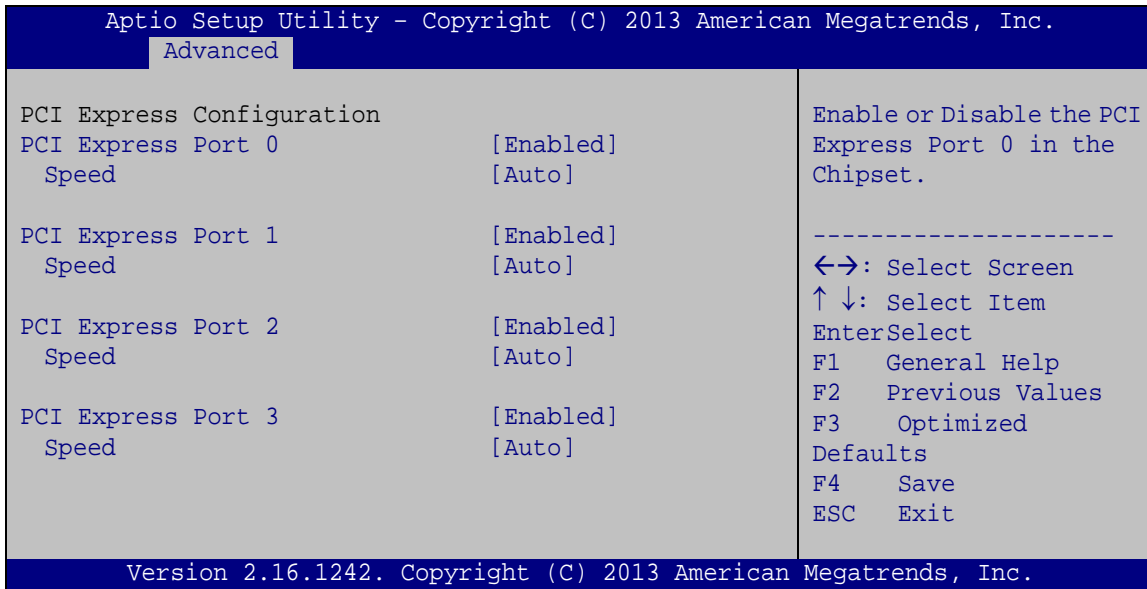

#### BIOS Menu 19: Console Redirection Settings

##### → PCI Express Port [Enabled]

Use the **PCI Express Port** option to enable or disable the PCI Express port.

- **Enabled**                      **DEFAULT**      Enables the PCI Express port.
- **Disabled**                                      Disables the PCI Express port.

##### → Speed [Auto]

Use the **Speed** option to configure PCIe port speed.

- **Auto**                                      Configure PCIe port speed to auto
- **Gen 2**                                      Configure PCIe port speed to Gen2
- **Gen 1**                                      Configure PCIe port speed to Gen1

## WAFER-BT-E38xx1W2

### 5.5 Security

Use the **Security** menu (**BIOS Menu 20**) to set system and user passwords.

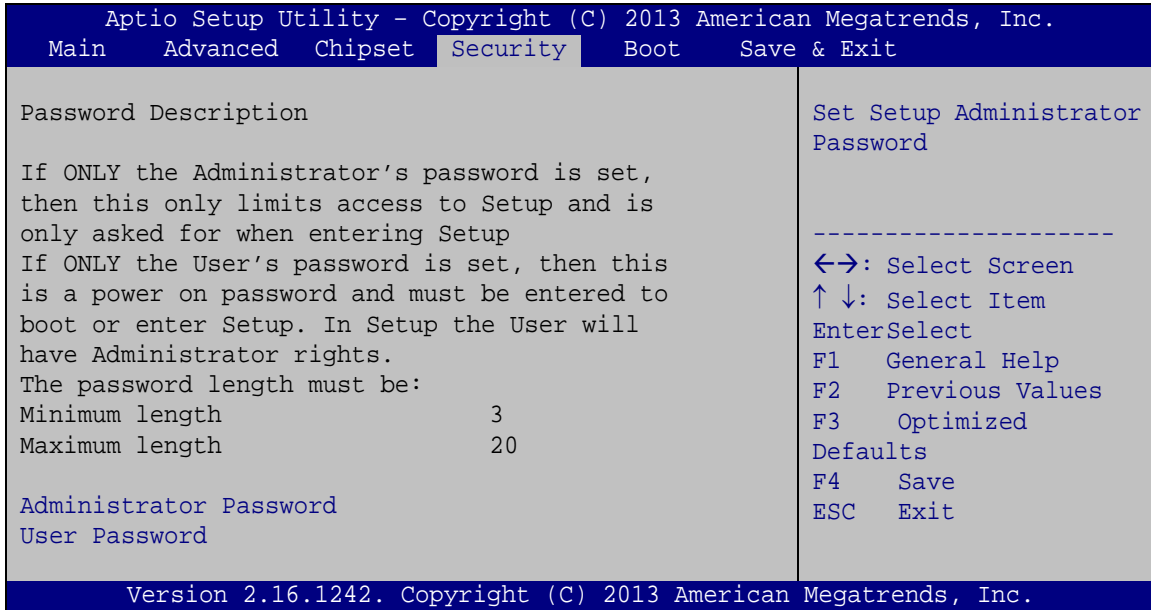

#### BIOS Menu 20: Security

##### → Administrator Password

Use the **Administrator Password** to set or change a administrator password.

##### → User Password

Use the **User Password** to set or change a user password.

## 5.6 Boot

Use the **Boot** menu (**BIOS Menu 21**) to configure system boot options.

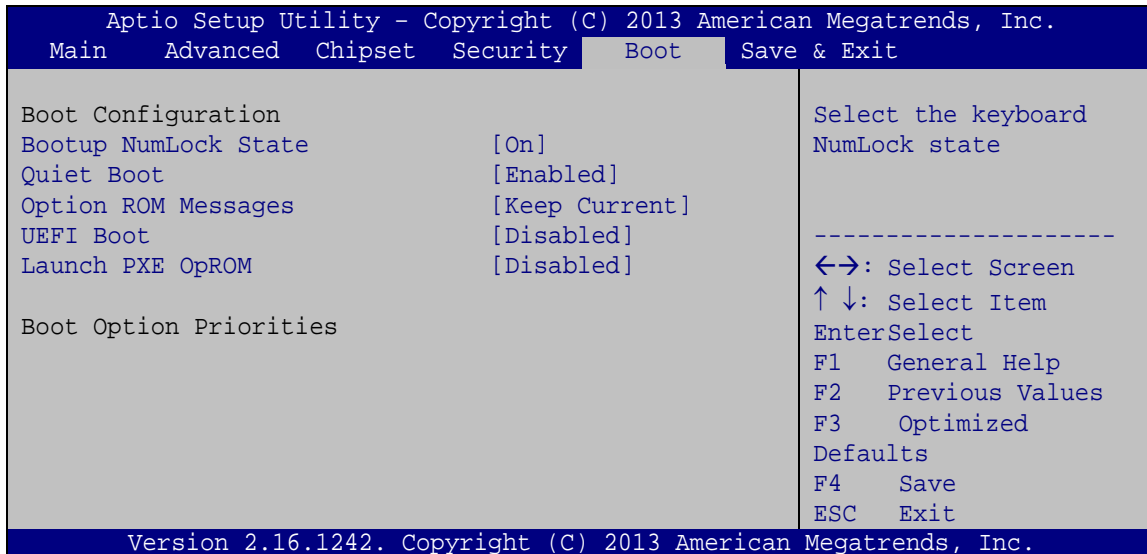

### BIOS Menu 21: Boot

#### → Bootup NumLock State [On]

Use the **Bootup NumLock State** BIOS option to specify if the number lock setting must be modified during boot up.

- **On**                      **DEFAULT**                      Allows the Number Lock on the keyboard to be enabled automatically when the computer system boots up. This allows the immediate use of the 10-key numeric keypad located on the right side of the keyboard. To confirm this, the Number Lock LED light on the keyboard is lit.
  
- **Off**                                      Does not enable the keyboard Number Lock automatically. To use the 10-keys on the keyboard, press the Number Lock key located on the upper left-hand corner of the 10-key pad. The Number Lock LED on the keyboard lights up when the Number Lock is engaged.

## WAFER-BT-E38xx1W2

### → Quiet Boot [Enabled]

Use the **Quiet Boot** BIOS option to select the screen display when the system boots.

- **Disabled** Normal POST messages displayed
- **Enabled** **DEFAULT** OEM Logo displayed instead of POST messages

### → Option ROM Messages [Keep Current]

Use the **Option ROM Messages** option to set the Option ROM display mode.

- **Force BIOS** Sets display mode to force BIOS.
- **Keep Current** **DEFAULT** Sets display mode to current.

### → UEFI Boot [Disabled]

Use the **UEFI Boot** option to enable or disable to boot from the UEFI devices.

- **Enabled** Boot from UEFI devices is enabled.
- **Disabled** **DEFAULT** Boot from UEFI devices is disabled.

### → Launch PXE OpROM [Disabled]

Use the **Launch PXE OpROM** option to enable or disable boot option for legacy network devices.

- **Disabled** **DEFAULT** Ignore all PXE Option ROMs
- **Enabled** Load PXE Option ROMs.

### → Boot Option Priority

Use the **Boot Option Priority** function to set the system boot sequence from the available devices. The drive sequence also depends on the boot sequence in the individual device section.

## 5.7 Exit

Use the **Exit** menu (**BIOS Menu 22**) to load default BIOS values, optimal failsafe values and to save configuration changes.

```
Aptio Setup Utility - Copyright (C) 2013 American Megatrends, Inc.
Main   Advanced  Chipset  Security  Boot   Save & Exit
-----
Save Changes and Reset
Discard Changes and Reset

Restore Defaults
Save as User Defaults
Restore User Defaults

Reset the system after
saving the changes.

-----
<->: Select Screen
↑ ↓: Select Item
Enter>Select
F1   General Help
F2   Previous Values
F3   Optimized
Defaults
F4   Save
ESC  Exit

Version 2.16.1242. Copyright (C) 2013 American Megatrends, Inc.
```

### BIOS Menu 22: Exit

#### → Save Changes and Reset

Use the **Save Changes and Reset** option to save the changes made to the BIOS options and to exit the BIOS configuration setup program.

#### → Discard Changes and Reset

Use the **Discard Changes and Reset** option to exit the system without saving the changes made to the BIOS configuration setup program.

#### → Restore Defaults

Use the **Restore Defaults** option to load the optimal default values for each of the parameters on the Setup menus. **F3 key can be used for this operation.**



## WAFER-BT-E38xx1W2

### → Save as User Defaults

Use the **Save as User Defaults** option to save the changes done so far as user defaults.

### → Restore User Defaults

Use the **Restore User Defaults** option to restore the user defaults to all the setup options.

Chapter

**6**

# Software Drivers

---

## WAFER-BT-E38xx1W2

### 6.1 Available Drivers

All the drivers for the WAFER-BT-E38xx1W2 are available on IEI Resource Download Center (<https://download.ieiworld.com>). Type WAFER-BT-E38xx1W2 and press Enter to find all the relevant software, utilities, and documentation.

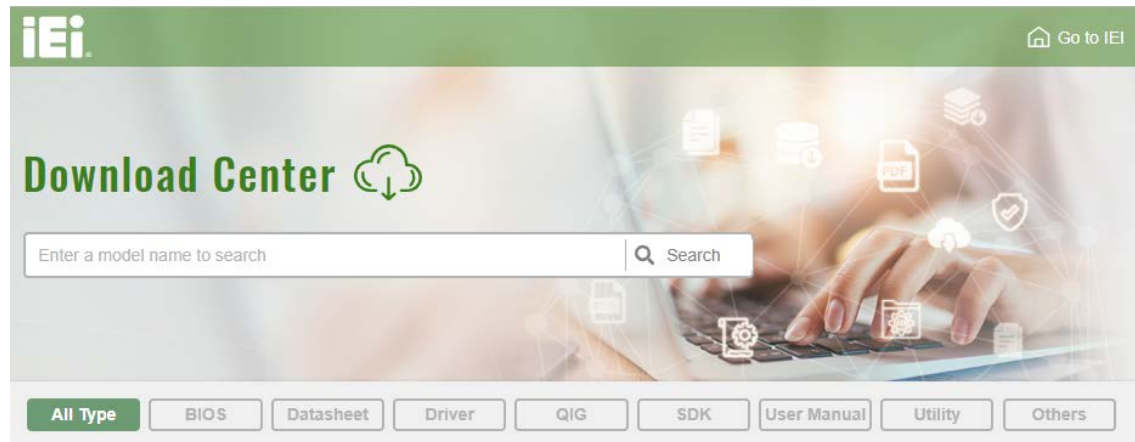
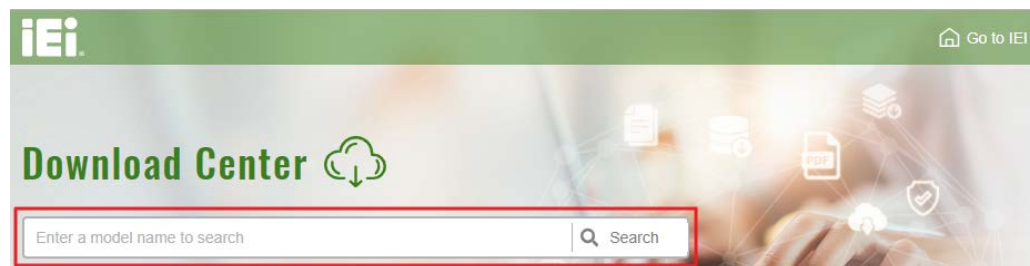

Figure 6-1: IEI Resource Download Center

### 6.2 Driver Download

To download drivers from IEI Resource Download Center, follow the steps below.

**Step 1:** Go to <https://download.ieiworld.com>. Type WAFER-BT-E38xx1W2 and press Enter.



**Step 2:** All product-related software, utilities, and documentation will be listed. You can choose **Driver** to filter the result.

[All Type](#)
[BIOS](#)
[Datasheet](#)
[Driver](#)
[QIG](#)
[SDK](#)
[User Manual](#)
[Utility](#)
[Others](#)

**WAFER-BT-i1** [Product Info](#)

[Embedded Computer](#) ▶ [Single Board Computer](#) ▶ [Embedded Board](#)  
 3.5" SBC with Intel® 22nm Atom™/Celeron® on-board SoC

**Driver**

File Name	Published	Version	File Checksum
<a href="#">7B000-001033-RS V2.3.iso (2.23 GB)</a>	2017/10/03	2.30	3B2DB1F792779A93A8F50DDDBC3943E30

**Step 3:** Click the driver file name on the page and you will be prompted with the following window. You can download the entire ISO file (❶), or double click an individual item to find its driver file and click the file name to download (❷).

7B000-001168-RS\_V1.4.iso

❶ [Click here to download entire ISO file. \(2.99 GB\)](#)

**\* Download individual file \***

- Docs
  - ❷ 1.Chipset
    - 10.1.1.12.zip (2.7 MB)
    - 2.VGA
    - 3.Audio
    - 4.Lan
    - 5.USB 3.0
    - 6.Serial IO
    - 7.TXE
    - 8.Manual



**NOTE:**

To install software from the downloaded ISO image file in Windows 8, 8.1 or 10, double-click the ISO file to mount it as a virtual drive to view its content. On Windows 7 system, an additional tool (such as Virtual CD-ROM Control Panel from Microsoft) is needed to mount the file.

Appendix

**A**

# Regulatory Compliance

---

**DECLARATION OF CONFORMITY**

This equipment has been tested and found to comply with specifications for CE marking. If the user modifies and/or installs other devices in the equipment, the CE conformity declaration may no longer apply.

**FCC WARNING**

This equipment complies with Part 15 of the FCC Rules. Operation is subject to the following two conditions:

- This device may not cause harmful interference, and
- This device must accept any interference received, including interference that may cause undesired operation.

This equipment has been tested and found to comply with the limits for a Class A digital device, pursuant to part 15 of the FCC Rules. These limits are designed to provide reasonable protection against harmful interference when the equipment is operated in a commercial environment. This equipment generates, uses, and can radiate radio frequency energy and, if not installed and used in accordance with the instruction manual, may cause harmful interference to radio communications. Operation of this equipment in a residential area is likely to cause harmful interference in which case the user will be required to correct the interference at his own expense.

Appendix

**B**

# Product Disposal

---

**CAUTION:**

Risk of explosion if battery is replaced by an incorrect type. Only certified engineers should replace the on-board battery.

Dispose of used batteries according to instructions and local regulations.

---

- Outside the European Union – If you wish to dispose of used electrical and electronic products outside the European Union, please contact your local authority so as to comply with the correct disposal method.
- Within the European Union – The device that produces less waste and is easier to recycle is classified as electronic device in terms of the European Directive 2012/19/EU (WEEE), and must not be disposed of as domestic garbage.

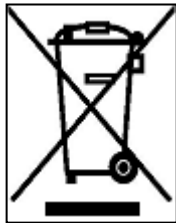

EU-wide legislation, as implemented in each Member State, requires that waste electrical and electronic products carrying the mark (left) must be disposed of separately from normal household waste. This includes monitors and electrical accessories, such as signal cables or power cords. When you need to dispose of your device, please follow the guidance of your local authority, or ask the shop where you purchased the product. The mark on electrical and electronic products only applies to the current European Union Member States.

Please follow the national guidelines for electrical and electronic product disposal.



Appendix

C

# BIOS Menu Options

---

<input type="checkbox"/>	System Date [xx/xx/xx].....	71
<input type="checkbox"/>	System Time [xx:xx:xx].....	71
<input type="checkbox"/>	ACPI Sleep State [S3 only (Suspend to RAM)] .....	72
<input type="checkbox"/>	Serial Port [Enabled].....	74
<input type="checkbox"/>	Change Settings [Auto].....	74
<input type="checkbox"/>	Serial Port [Enabled].....	75
<input type="checkbox"/>	Change Settings [Auto].....	75
<input type="checkbox"/>	Serial Port [Enabled].....	76
<input type="checkbox"/>	Change Settings [Auto].....	76
<input type="checkbox"/>	PC Health Status .....	77
<input type="checkbox"/>	CPU Smart Fan control [Auto PWM Mode].....	78
<input type="checkbox"/>	Temperature of Off [75] .....	79
<input type="checkbox"/>	Temperature of Start [80] .....	79
<input type="checkbox"/>	Start PWM [30].....	80
<input type="checkbox"/>	Slope (Duty Cycle) [4].....	80
<input type="checkbox"/>	Wake system with Fixed Time [Disabled].....	81
<input type="checkbox"/>	Console Redirection [Disabled] .....	82
<input type="checkbox"/>	Terminal Type [ANSI].....	83
<input type="checkbox"/>	Bits per second [115200].....	84
<input type="checkbox"/>	Data Bits [8] .....	84
<input type="checkbox"/>	Parity [None].....	84
<input type="checkbox"/>	Stop Bits [1].....	85
<input type="checkbox"/>	Auto Recovery Function [Disabled].....	85
<input type="checkbox"/>	Intel® Virtualization Technology [Disabled] .....	86
<input type="checkbox"/>	EIST [Enabled].....	86
<input type="checkbox"/>	SATA Mode [ACHI Mode] .....	87
<input type="checkbox"/>	Serial-ATA Port 1/2 [Enabled].....	87
<input type="checkbox"/>	SATA Port 1/0 HotPlug [Disabled].....	88
<input type="checkbox"/>	USB Devices .....	88
<input type="checkbox"/>	Legacy USB Support [Enabled].....	89
<input type="checkbox"/>	Memory Information .....	91
<input type="checkbox"/>	DVMT Pre-Allocated [256MB].....	91
<input type="checkbox"/>	DVMT Total Gfx Mem [Max].....	92
<input type="checkbox"/>	DP Selection [DP to HDMI/CRT/DP] .....	92

**WAFER-BT-E38xx1W2**

<input type="checkbox"/>	Primary IGFX Boot Display [VBIOS Default] .....	92
<input type="checkbox"/>	Audio Controller [Enabled] .....	93
<input type="checkbox"/>	XHCI Mode [Auto] .....	93
<input type="checkbox"/>	PCI Express Port [Enabled] .....	94
<input type="checkbox"/>	Speed [Auto].....	94
<input type="checkbox"/>	Administrator Password .....	95
<input type="checkbox"/>	User Password .....	95
<input type="checkbox"/>	Bootup NumLock State [On].....	96
<input type="checkbox"/>	Quiet Boot [Enabled] .....	97
<input type="checkbox"/>	Option ROM Messages [Keep Current] .....	97
<input type="checkbox"/>	UEFI Boot [Disabled] .....	97
<input type="checkbox"/>	Launch PXE OpROM [Disabled].....	97
<input type="checkbox"/>	Boot Option Priority.....	97
<input type="checkbox"/>	Save Changes and Reset .....	98
<input type="checkbox"/>	Discard Changes and Reset .....	98
<input type="checkbox"/>	Restore Defaults .....	98
<input type="checkbox"/>	Save as User Defaults .....	99
<input type="checkbox"/>	Restore User Defaults .....	99

Appendix

**D**

# Digital I/O Interface

---

## WAFER-BT-E38xx1W2

### D.1 Introduction

The DIO connector on the WAFER-BT-E38xx1W2 is interfaced to GPIO ports on the Super I/O chipset. The digital inputs and digital outputs are generally control signals that control the on/off circuit of external devices or TTL devices. Data can be read or written to the selected address to enable the DIO functions.



#### NOTE:

For further information, please refer to the datasheet for the Super I/O chipset.

---

The BIOS interrupt call **INT 15H** controls the digital I/O.

#### INT 15H:

<b>AH – 6FH</b>	
<u>Sub-function:</u>	
<b>AL – 8</b>	: Set the digital port as INPUT
<b>AL</b>	: Digital I/O input value

### D.2 Assembly Language Sample 1

```
MOV     AX, 6F08H      ;setting the digital port as input
INT     15H           ;
```

AL low byte = value

AH – 6FH	
<u>Sub-function:</u>	
AL – 9	: Set the digital port as OUTPUT
BL	: Digital I/O input value

### D.3 Assembly Language Sample 2

```
MOV     AX, 6F09H      ;setting the digital port as output
MOV     BL, 09H        ;digital value is 09H
INT     15H           ;
```

Digital Output is 1001b

Appendix

E

# Watchdog Timer

---

**NOTE:**

The following discussion applies to DOS. Contact IEI support or visit the IEI website for drivers for other operating systems.

The Watchdog Timer is a hardware-based timer that attempts to restart the system when it stops working. The system may stop working because of external EMI or software bugs. The Watchdog Timer ensures that standalone systems like ATMs will automatically attempt to restart in the case of system problems.

A BIOS function call (INT 15H) is used to control the Watchdog Timer.

INT 15H:

<b>AH – 6FH Sub-function:</b>	
AL – 2:	Sets the Watchdog Timer's period.
BL:	Time-out value (Its unit-second is dependent on the item "Watchdog Timer unit select" in CMOS setup).

**Table E-1: AH-6FH Sub-function**

Call sub-function 2 to set the time-out period of Watchdog Timer first. If the time-out value is not zero, the Watchdog Timer starts counting down. When the timer value reaches zero, the system resets. To ensure that this reset condition does not occur, calling sub-function 2 must periodically refresh the Watchdog Timer. However, the watchdog timer is disabled if the time-out value is set to zero.

A tolerance of at least 10% must be maintained to avoid unknown routines within the operating system (DOS), such as disk I/O that can be very time-consuming.



## WAFER-BT-E38xx1W2



### NOTE:

The Watchdog Timer is activated through software. The software application that activates the Watchdog Timer must also deactivate it when closed. If the Watchdog Timer is not deactivated, the system will automatically restart after the Timer has finished its countdown.

### EXAMPLE PROGRAM:

**; INITIAL TIMER PERIOD COUNTER**

;

**W\_LOOP:**

;

```

MOV      AX, 6F02H      ;setting the time-out value
MOV      BL, 30         ;time-out value is 48 seconds
INT      15H

```

;

**; ADD THE APPLICATION PROGRAM HERE**

;

```

CMP      EXIT_AP, 1     ;is the application over?
JNE      W_LOOP        ;No, restart the application

```

```

MOV      AX, 6F02H      ;disable Watchdog Timer
MOV      BL, 0          ;
INT      15H

```

;

**; EXIT ;**

Appendix

**F**

# Error Beep Code

---

## WAFER-BT-E38xx1W2

### F.1 PEI Beep Codes

Number of Beeps	Description
1	Memory not Installed
1	Memory was installed twice (InstallPeiMemory routine in PEI Core called twice)
2	Recovery started
3	DXE IPL was not found
3	DXE Core Firmware Volume was not found
4	Recovery failed
4	S3 Resume failed
7	Reset PPI is not available

### F.2 DXE Beep Codes

Number of Beeps	Description
1	Invalid password
4	Some of the Architectural Protocols are not available
5	No Console Output Devices are found
5	No Console Input Devices are found
6	Flash update is failed
7	Reset protocol is not available
8	Platform PCI resource requirements cannot be met



#### NOTE:

If you have any question, please contact IEI for further assistance.

Appendix

**G**

# Hazardous Materials Disclosure

---

## WAFER-BT-E38xx1W2

### G.1 RoHS II Directive (2015/863/EU)

The details provided in this appendix are to ensure that the product is compliant with the RoHS II Directive (2015/863/EU). The table below acknowledges the presences of small quantities of certain substances in the product, and is applicable to RoHS II Directive (2015/863/EU).

Please refer to the following table.

Part Name	Toxic or Hazardous Substances and Elements									
	Lead (Pb)	Mercury (Hg)	Cadmium (Cd)	Hexavalent Chromium (CR(VI))	Polybrominated Biphenyls (PBB)	Polybrominated Diphenyl Ethers (PBDE)	Bis(2-ethylhexyl) phthalate (DEHP)	Butyl benzyl phthalate (BBP)	Dibutyl phthalate (DBP)	Diisobutyl phthalate (DIBP)
Housing	O	O	O	O	O	O	O	O	O	O
Display	O	O	O	O	O	O	O	O	O	O
Printed Circuit Board	O	O	O	O	O	O	O	O	O	O
Metal Fasteners	O	O	O	O	O	O	O	O	O	O
Cable Assembly	O	O	O	O	O	O	O	O	O	O
Fan Assembly	O	O	O	O	O	O	O	O	O	O
Power Supply Assemblies	O	O	O	O	O	O	O	O	O	O
Battery	O	O	O	O	O	O	O	O	O	O

O: This toxic or hazardous substance is contained in all of the homogeneous materials for the part is below the limit requirement in Directive (EU) 2015/863.

X: This toxic or hazardous substance is contained in at least one of the homogeneous materials for this part is above the limit requirement in Directive (EU) 2015/863.

## G.2 China RoHS

此附件旨在确保本产品符合中国 RoHS 标准。以下表格标示此产品中某有毒物质的含量符合中国 RoHS 标准规定的限量要求。

本产品上会附有“环境友好使用期限”的标签，此期限是估算这些物质“不会有泄漏或突变”的年限。本产品可能包含有较短的环境友好使用期限的可替换元件，像是电池或灯管，这些元件将会单独标示出来。

部件名称	有毒有害物质或元素					
	铅 (Pb)	汞 (Hg)	镉 (Cd)	六价铬 (CR(VI))	多溴联苯 (PBB)	多溴二苯醚 (PBDE)
壳体	○	○	○	○	○	○
显示	○	○	○	○	○	○
印刷电路板	○	○	○	○	○	○
金属螺帽	○	○	○	○	○	○
电缆组装	○	○	○	○	○	○
风扇组装	○	○	○	○	○	○
电力供应组装	○	○	○	○	○	○
电池	○	○	○	○	○	○
<p>○: 表示该有毒有害物质在该部件所有物质材料中的含量均在 SJ/T11364-2014 與 GB/T26572-2011 标准规定的限量要求以下。</p> <p>X: 表示该有毒有害物质至少在该部件的某一均质材料中的含量超出 SJ/T11364-2014 與 GB/T26572-2011 标准规定的限量要求。</p>						