



**MODEL:  
SPCIE-C236**

**Full-Size PICMG 1.3 CPU Card Supports LGA1151 Intel® Xeon® E3 v5/v6, 6th/7th Generation Intel® Core™ i7/i5/i3, Pentium® or Celeron® CPU, Intel® C236 Chipset, DDR4, Dual Intel® PCIe GbE, VGA, iDP, USB, SATA 6Gb/s, mSATA, Intel® AMT and RoHS**

# User Manual

# Revision

---

Date	Version	Changes
July 8, 2021	1.04	Updated Section 2.3: Packing List Updated Chapter 6: Software Drivers
September 20, 2018	1.03	Modified pin locations of JSPI1 and JSPI2 connectors
November 13, 2017	1.02	Updated supported CPUs
September 11, 2017	1.01	Added Intel® Core™ i7/i5 as supported CPU
October 27, 2016	1.00	Initial release

# Copyright

---

## **COPYRIGHT NOTICE**

The information in this document is subject to change without prior notice in order to improve reliability, design and function and does not represent a commitment on the part of the manufacturer.

In no event will the manufacturer be liable for direct, indirect, special, incidental, or consequential damages arising out of the use or inability to use the product or documentation, even if advised of the possibility of such damages.

This document contains proprietary information protected by copyright. All rights are reserved. No part of this manual may be reproduced by any mechanical, electronic, or other means in any form without prior written permission of the manufacturer.

## **TRADEMARKS**

All registered trademarks and product names mentioned herein are used for identification purposes only and may be trademarks and/or registered trademarks of their respective owners.

# Manual Conventions

---



## **WARNING**

Warnings appear where overlooked details may cause damage to the equipment or result in personal injury. Warnings should be taken seriously.



## **CAUTION**

Cautionary messages should be heeded to help reduce the chance of losing data or damaging the product.



## **NOTE**

These messages inform the reader of essential but non-critical information. These messages should be read carefully as any directions or instructions contained therein can help avoid making mistakes.



## **HOT SURFACE**

This symbol indicates a hot surface that should not be touched without taking care.

# Table of Contents

<b>1 INTRODUCTION.....</b>	<b>1</b>
1.1 INTRODUCTION.....	2
1.2 MODEL VARIATIONS .....	3
1.3 FEATURES.....	3
1.4 CONNECTORS .....	4
1.5 DIMENSIONS.....	5
1.6 DATA FLOW .....	6
1.7 TECHNICAL SPECIFICATIONS .....	7
<b>2 PACKING LIST.....</b>	<b>10</b>
2.1 ANTI-STATIC PRECAUTIONS .....	11
2.2 UNPACKING PRECAUTIONS.....	11
2.3 PACKING LIST.....	12
2.4 OPTIONAL ITEMS .....	13
<b>3 CONNECTORS .....</b>	<b>15</b>
3.1 PERIPHERAL INTERFACE CONNECTORS.....	16
3.1.1 SPCIE-C236 Layout.....	16
3.1.2 Peripheral Interface Connectors .....	17
3.1.3 External Interface Panel Connectors.....	18
3.2 INTERNAL PERIPHERAL CONNECTORS .....	19
3.2.1 +12V ATX Power Connector .....	19
3.2.2 Audio Kit Connector .....	20
3.2.3 Battery Connector.....	21
3.2.4 Chassis Intrusion Connector.....	22
3.2.5 CRT FW Update Connector.....	23
3.2.6 DDR4 DIMM Sockets .....	24
3.2.7 Digital I/O Connector.....	25
3.2.8 EC Debug Connector.....	26
3.2.9 Fan Connector (CPU).....	27



3.2.10 Fan Connectors (System).....	28
3.2.11 Front Panel Connector.....	29
3.2.12 $\dot{P}$ C Connector.....	30
3.2.13 Internal DisplayPort Connector.....	31
3.2.14 iRIS-2400 Module Slot (SPCIE-C236-i2 Only).....	32
3.2.15 Keyboard and Mouse Connector.....	33
3.2.16 LAN LED Connectors.....	34
3.2.17 Parallel Port Connector.....	35
3.2.18 PCIe Mini Slot.....	36
3.2.19 Power Button.....	37
3.2.20 RS-232 Serial Port Connectors.....	38
3.2.21 RS-232/422/485 Serial Port Connectors.....	39
3.2.22 SATA 6Gb/s Drive Connector.....	40
3.2.23 SMBus Connector.....	41
3.2.24 SPI Flash Connector.....	42
3.2.25 SPI Flash Connector, EC.....	43
3.2.26 TPM Connector.....	44
3.2.27 USB 2.0 Connectors.....	45
3.2.28 USB 2.0 Connector (Type A).....	46
3.2.29 USB 3.2 Gen 1 Connector.....	47
<b>3.3 EXTERNAL PERIPHERAL INTERFACE CONNECTOR PANEL.....</b>	<b>48</b>
3.3.1 Ethernet Connectors.....	48
3.3.2 USB 3.2 Gen 1 Connectors.....	49
3.3.3 VGA Connector.....	50
<b>4 INSTALLATION.....</b>	<b>51</b>
4.1 ANTI-STATIC PRECAUTIONS.....	52
4.2 INSTALLATION CONSIDERATIONS.....	52
4.3 SOCKET LGA1151 CPU INSTALLATION.....	54
4.4 SOCKET LGA1151 COOLING KIT INSTALLATION.....	57
4.5 DIMM INSTALLATION.....	59
4.6 iRIS-2400 MODULE INSTALLATION (OPTIONAL).....	60
4.7 FULL-SIZE PCIe MINI CARD INSTALLATION.....	61
4.8 HALF-SIZE PCIe MINI CARD INSTALLATION.....	62
4.9 SYSTEM CONFIGURATION.....	64

## SPCIE-C236 Full-size PICMG 1.3 CPU Card

4.9.1 AT/ATX Power Mode Setting .....	64
4.9.2 Clear CMOS Button.....	65
4.9.3 PCIe x4 Channel Mode Setup.....	65
4.9.4 PCIe x16 Channel Mode Setup.....	66
4.9.5 Flash Descriptor Security Override Jumper.....	67
4.9.6 USB Power Selection.....	68
4.9.7 mSATA Setup .....	69
4.10 INTERNAL PERIPHERAL DEVICE CONNECTIONS.....	69
4.10.1 SATA Drive Connection .....	69
4.11 ADDING USB 3.2 GEN 1 DRIVERS TO A WINDOWS 7 INSTALLATION IMAGE .....	71
4.12 INTEL® AMT SETUP PROCEDURE.....	73
4.13 IPMI SETUP PROCEDURE (SPCIE-C236-I2 ONLY).....	73
4.13.1 Managed System Hardware Setup .....	74
4.13.2 Using the IEI iMAN Web GUI.....	74
<b>5 BIOS.....</b>	<b>76</b>
5.1 INTRODUCTION.....	77
5.1.1 Starting Setup.....	77
5.1.2 Using Setup .....	77
5.1.3 Getting Help.....	78
5.1.4 Unable to Reboot after Configuration Changes .....	78
5.1.5 BIOS Menu Bar.....	78
5.2 MAIN.....	78
5.3 ADVANCED.....	80
5.3.1 Trusted Computing.....	81
5.3.2 ACPI Settings.....	82
5.3.3 AMT Configuration.....	83
5.3.4 Super IO Configuration .....	84
5.3.4.1 Serial Port n Configuration.....	85
5.3.4.2 Parallel Port Configuration .....	89
5.3.5 iWDD H/W Monitor.....	90
5.3.5.1 Smart Fan Mode Configuration .....	92
5.3.6 RTC Wake Settings.....	93
5.3.7 Serial Port Console Redirection .....	94
5.3.7.1 Legacy Console Redirection Settings.....	97

5.3.8 CPU Configuration .....	98
5.3.9 SATA Configuration.....	100
5.3.10 NVMe Configuration.....	101
5.3.11 USB Configuration.....	102
5.3.12 iEi Feature .....	103
<b>5.4 CHIPSET .....</b>	<b>104</b>
5.4.1 System Agent (SA) Configuration .....	105
5.4.1.1 Graphics Configuration.....	106
5.4.1.2 PEG Port Configuration.....	108
5.4.1.3 Memory Configuration .....	109
5.4.2 PCH-IO Configuration .....	110
5.4.2.1 PCI Express Configuration .....	112
5.4.2.2 HD Audio Configuration.....	114
5.5 SECURITY.....	115
5.6 BOOT.....	116
5.7 SAVE & EXIT .....	118
5.8 SERVER MGMT (SPCIE-C236-I2 ONLY) .....	119
5.8.1 System Event Log.....	119
5.8.2 BMC Network Configuration.....	121
<b>6 SOFTWARE DRIVERS .....</b>	<b>123</b>
6.1 AVAILABLE DRIVERS .....	124
6.2 DRIVER DOWNLOAD .....	124
<b>A REGULATORY COMPLIANCE .....</b>	<b>126</b>
<b>B PRODUCT DISPOSAL .....</b>	<b>128</b>
<b>C BIOS OPTIONS .....</b>	<b>130</b>
<b>D DIGITAL I/O INTERFACE.....</b>	<b>134</b>
D.1 INTRODUCTION.....	135
D.2 ASSEMBLY LANGUAGE SAMPLE 1.....	136
D.3 ASSEMBLY LANGUAGE SAMPLE 2.....	136
<b>E WATCHDOG TIMER.....</b>	<b>137</b>
<b>F ERROR BEEP CODE .....</b>	<b>140</b>



## SPCIE-C236 Full-size PICMG 1.3 CPU Card

F.1 PEI BEEP CODES .....	141
F.2 DXE BEEP CODES .....	141
<b>G HAZARDOUS MATERIALS DISCLOSURE .....</b>	<b>142</b>
G.1 RoHS II DIRECTIVE (2015/863/EU).....	143
G.2 CHINA RoHS .....	144

# List of Figures

---

Figure 1-1: SPCIE-C236.....	2
Figure 1-2: Connectors .....	4
Figure 1-3: SPCIE-C236 Dimensions (mm) .....	5
Figure 1-4: Data Flow Diagram.....	6
Figure 3-1: Peripheral Interface Connectors .....	16
Figure 3-2: +12V ATX Power Connector Pinout Location .....	19
Figure 3-3: Audio Connector Location .....	20
Figure 3-4: Battery Connector Location.....	21
Figure 3-5: Chassis Intrusion Connector Location.....	22
Figure 3-6: CRT FW Update Connector Location.....	23
Figure 3-7: DDR4 DIMM Socket Locations .....	24
Figure 3-8: Digital I/O Connector Location .....	25
Figure 3-9: EC Debug Connector Location .....	26
Figure 3-10: CPU Fan Connector Location .....	27
Figure 3-11: System Fan Connector Location.....	28
Figure 3-12: Front Panel Connector Location .....	29
Figure 3-13: I <sup>2</sup> C Connector Location .....	30
Figure 3-14: Internal DisplayPort Connector Location .....	31
Figure 3-15: iRIS-2400 Module Slot Location .....	32
Figure 3-16: Keyboard and Mouse Connector Location.....	33
Figure 3-17: LAN LED Connector Locations .....	34
Figure 3-18: Parallel Port Connector Location .....	35
Figure 3-19: PCIe Mini Slot Location .....	36
Figure 3-20: Power Button Location.....	38
Figure 3-21: RS-232 Serial Port Connector Locations.....	38
Figure 3-22: RS-232/422/485 Serial Port Connector Locations.....	39
Figure 3-23: SATA 6Gb/s Drive Connector Locations .....	40
Figure 3-24: SMBus Connector Location .....	41
Figure 3-25: SPI Flash Connector Location.....	42
Figure 3-26: SPI EC Flash Connector Location.....	43

## SPCIE-C236 Full-size PICMG 1.3 CPU Card

Figure 3-27: TPM Connector Location.....	44
Figure 3-28: USB 2.0 Connector Locations .....	45
Figure 3-29: USB 2.0 Connector (Type A) Pinout Location.....	46
Figure 3-30: USB 3.2 Gen 1 Connector Location .....	47
Figure 3-31: External Peripheral Interface Connector .....	48
Figure 3-32: Ethernet Connector.....	48
Figure 3-33: VGA Connector .....	50
Figure 4-1: Disengage the CPU Socket Load Lever.....	54
Figure 4-2: Remove Protective Cover.....	55
Figure 4-3: Insert the Socket LGA1151 CPU.....	56
Figure 4-4: Close the Socket LGA1151 .....	56
Figure 4-5: Cooling Kit Support Bracket.....	58
Figure 4-6: DIMM Installation.....	59
Figure 4-7: iRIS-2400 Module Installation .....	60
Figure 4-8: Removing the Retention Screw .....	61
Figure 4-9: Inserting the Full-size PCIe Mini Card into the Slot at an Angle .....	61
Figure 4-10: Securing the Full-size PCIe Mini Card .....	62
Figure 4-11: Installing the Standoff .....	63
Figure 4-12: Inserting the Half-size PCIe Mini Card into the Slot at an Angle.....	63
Figure 4-13: Securing the Half-size PCIe Mini Card.....	64
Figure 4-14: AT/ATX Power Mode Switch Location .....	64
Figure 4-15: Clear CMOS Button Location.....	65
Figure 4-16: BIOS Switch Location.....	65
Figure 4-17: Flash Descriptor Security Override Jumper Location .....	67
Figure 4-18: mSATA Setup Jumper Location .....	69
Figure 4-19: SATA Drive Cable Connection.....	70
Figure 4-20: SATA Power Drive Connection.....	70
Figure 4-21: Windows 7 USB 3.0 Creator Utility.....	72
Figure 4-22: Update Process is Complete .....	72
Figure 4-23: IEI iMAN Web Address.....	74
Figure 4-24: IEI iMAN Web GUI.....	75
Figure 6-1: IEI Resource Download Center.....	124

# List of Tables

---

Table 1-1: SPCIE-C236 Model Variations .....	3
Table 1-2: SPCIE-C236 Specifications.....	9
Table 2-1: Packing List.....	12
Table 2-2: Optional Items .....	14
Table 3-1: Peripheral Interface Connectors .....	18
Table 3-2: External Peripheral Connectors .....	18
Table 3-3: +12V ATX Power Connector Pinouts .....	19
Table 3-4: Audio Connector Pinouts .....	20
Table 3-5: Battery Connector Pinouts .....	21
Table 3-6: Chassis Intrusion Connector Pinouts .....	22
Table 3-7: CRT FW Update Connector Pinouts .....	23
Table 3-8: Digital I/O Connector Pinouts.....	25
Table 3-9: EC Debug Connector Pinouts .....	26
Table 3-10: CPU Fan Connector Pinouts .....	27
Table 3-11: System Fan (SYS_FAN1) Connector Pinouts .....	28
Table 3-12: Front Panel Connector Pinouts.....	29
Table 3-13: I <sup>2</sup> C Connector Pinouts.....	30
Table 3-14: Internal DisplayPort Connector Pinouts .....	31
Table 3-15: Keyboard and Mouse Connector Pinouts .....	33
Table 3-16: LAN1 LED Connector (LED_LAN1) Pinouts.....	34
Table 3-17: LAN2 LED Connector (LED_LAN2) Pinouts.....	34
Table 3-18: Parallel Port Connector Pinouts .....	35
Table 3-19: PCIe Mini Slot Pinouts.....	37
Table 3-20: RS-232 Serial Port Connector Pinouts .....	38
Table 3-21: RS-232/422/485 Serial Port Connector Pinouts .....	39
Table 3-22: DB-9 RS-232/422/485 Pinouts .....	40
Table 3-23: SATA 6Gb/s Drive Connector Pinouts.....	41
Table 3-24: SMBus Connector Pinouts .....	42
Table 3-25: SPI Flash Connector Pinouts .....	42
Table 3-26: SPI EC Flash Connector Pinouts .....	43

## SPCIE-C236 Full-size PICMG 1.3 CPU Card

Table 3-27: TPM Connector Pinouts .....	44
Table 3-28: USB 2.0 Connector Pinouts .....	45
Table 3-29: USB 2.0 Connector (Type A) Pinouts .....	46
Table 3-30: USB 3.2 Gen 1 Connector Pinouts .....	47
Table 3-31: LAN Pinouts .....	48
Table 3-32: USB 3.2 Gen 1 Port Pinouts .....	49
Table 3-33: VGA Connector Pinouts .....	50
Table 4-1: AT/ATX Power Mode Switch Settings .....	64
Table 4-2: BIOS Switch Settings .....	65
Table 4-3: PCIe x16 Channel Mode Setup .....	66
Table 4-4: Flash Descriptor Security Override Jumper Settings .....	67
Table 4-5: BIOS Options and Configured USB Ports .....	68
Table 4-6: USB Power Source Setup .....	68
Table 4-7: mSATA Setup Jumper Settings .....	69
Table 5-1: BIOS Navigation Keys .....	78
Table 5-2: BIOS Options and Configured USB Ports .....	111



# BIOS Menus

---

BIOS Menu 1: Main .....	79
BIOS Menu 2: Advanced .....	80
BIOS Menu 3: Trusted Computing .....	81
BIOS Menu 4: ACPI Configuration .....	82
BIOS Menu 5: AMT Configuration .....	83
BIOS Menu 6: Super IO Configuration.....	84
BIOS Menu 7: Serial Port n Configuration Menu .....	85
BIOS Menu 8: Parallel Port Configuration Menu .....	89
BIOS Menu 9: iWDD H/W Monitor .....	91
BIOS Menu 10: Smart Fan Mode Configuration .....	92
BIOS Menu 11: RTC Wake Settings .....	93
BIOS Menu 12: Serial Port Console Redirection .....	94
BIOS Menu 13: Legacy Console Redirection Settings .....	97
BIOS Menu 14: CPU Configuration .....	98
BIOS Menu 15: SATA Configuration .....	100
BIOS Menu 16: NVMe Configuration.....	101
BIOS Menu 17: USB Configuration .....	102
BIOS Menu 18: iEi Feature .....	103
BIOS Menu 19: Chipset .....	104
BIOS Menu 20: System Agent (SA) Configuration .....	105
BIOS Menu 21: Graphics Configuration .....	106
BIOS Menu 22: PEG Port Configuration.....	108
BIOS Menu 23: Memory Configuration.....	109
BIOS Menu 24: PCH-IO Configuration .....	110
BIOS Menu 25: PCI Express Configuration (For BIOS1) .....	112
BIOS Menu 26: PCI Express Configuration (For BIOS2) .....	112
BIOS Menu 27: PCIEX1 Slot/PCIEX4 Slot/MPCIE Slot.....	113
BIOS Menu 28: HD Audio Configuration .....	114
BIOS Menu 29: Security .....	115
BIOS Menu 30: Boot .....	116

## SPCIE-C236 Full-size PICMG 1.3 CPU Card

BIOS Menu 31: Save & Exit.....	118
BIOS Menu 32: Server Mgmt .....	119
BIOS Menu 33: System Event Log .....	119
BIOS Menu 34: System Event Log .....	121



Chapter

1

# Introduction

---

## 1.1 Introduction

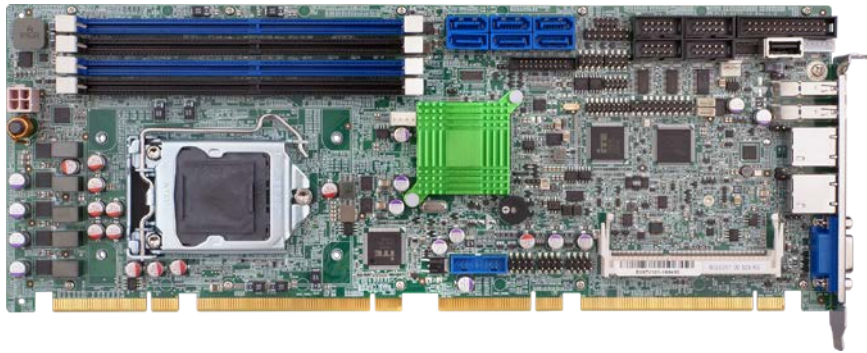

**Figure 1-1: SPCIE-C236**

The SPCIE-C236 is a full-size PICMG 1.3 CPU card. It accepts a Socket LGA1151 Intel® Xeon® E3 v5/v6, 6th/7th generation Intel® Core™ i7/i5/i3, Pentium® or Celeron® processor and supports four 288-pin 2133 MHz dual-channel DDR4 DIMM modules up to 64 GB.

The SPCIE-C236 provides two GbE interfaces through the Intel® I219LM (with Intel® AMT 11.0 support) and the Intel® I210 PCIe controllers. The integrated Intel® C236 chipset supports six SATA 6Gb/s drives with RAID 0/1/5/10 function. In addition, the SPCIE-C236 includes VGA and iDP interfaces for dual independent display.

Two USB 3.2 Gen 1 (5Gb/s) on the rear panel, two USB 3.2 Gen 1 (5Gb/s) by internal box header, six USB 2.0 by pin headers, one USB 2.0 by internal Type A connector, two RS-232, two RS-232/422/485 and one PCIe Mini interface provide flexible expansion options. High Definition Audio (HDA) support ensures HDA devices can be easily implemented on the SPCIE-C236.



## SPCIE-C236 Full-size PICMG 1.3 CPU Card

### 1.2 Model Variations

The model variations of the SPCIE-C236 series are listed below.

Model No.	Supported CPU	iRIS-2400 Module Slot
SPCIE-C236	LGA1151 Intel® Xeon® E3 v5/v6, 6th/7th generation Intel® Core™	No
SPCIE-C236-i2	i7/i5/i3, Pentium® or Celeron®	Yes

**Table 1-1: SPCIE-C236 Model Variations**

### 1.3 Features

Some of the SPCIE-C236 motherboard features are listed below:

- Full-size PICMG 1.3 CPU card
- LGA1151 Intel® Xeon® E3 v5/v6, 6th/7th generation Intel® Core™ i7/i5/i3, Pentium® or Celeron® processor supported
- Intel® C236 chipset
- Four 288-pin 2133/1867 MHz dual-channel ECC/non-ECC unbuffered DDR4 SDRAM DIMMs support (system max. 64 GB)
- Two Intel® PCIe GbE connectors (LAN1 with Intel® AMT 11.0 support)
- Dual independent display by VGA and iDP interfaces
- One full-size/half-size PCIe Mini slot supports mSATA
- Six SATA 6Gb/s connectors support RAID 0, 1, 5, 10 function
- Two USB 3.2 Gen 1 (5Gb/s) ports on the rear I/O
- Two USB 3.2 Gen 1 (5Gb/s) ports via internal box header
- Six USB 2.0 ports via internal pin headers
- One USB 2.0 via internal Type A connector
- Two RS-232 serial ports
- Two RS-232/422/485 serial ports
- TPM V1.2 hardware security function supported by TPM module
- High Definition Audio
- RoHS compliant

### 1.4 Connectors

The connectors on the SPCIE-C236 are shown in the figure below.

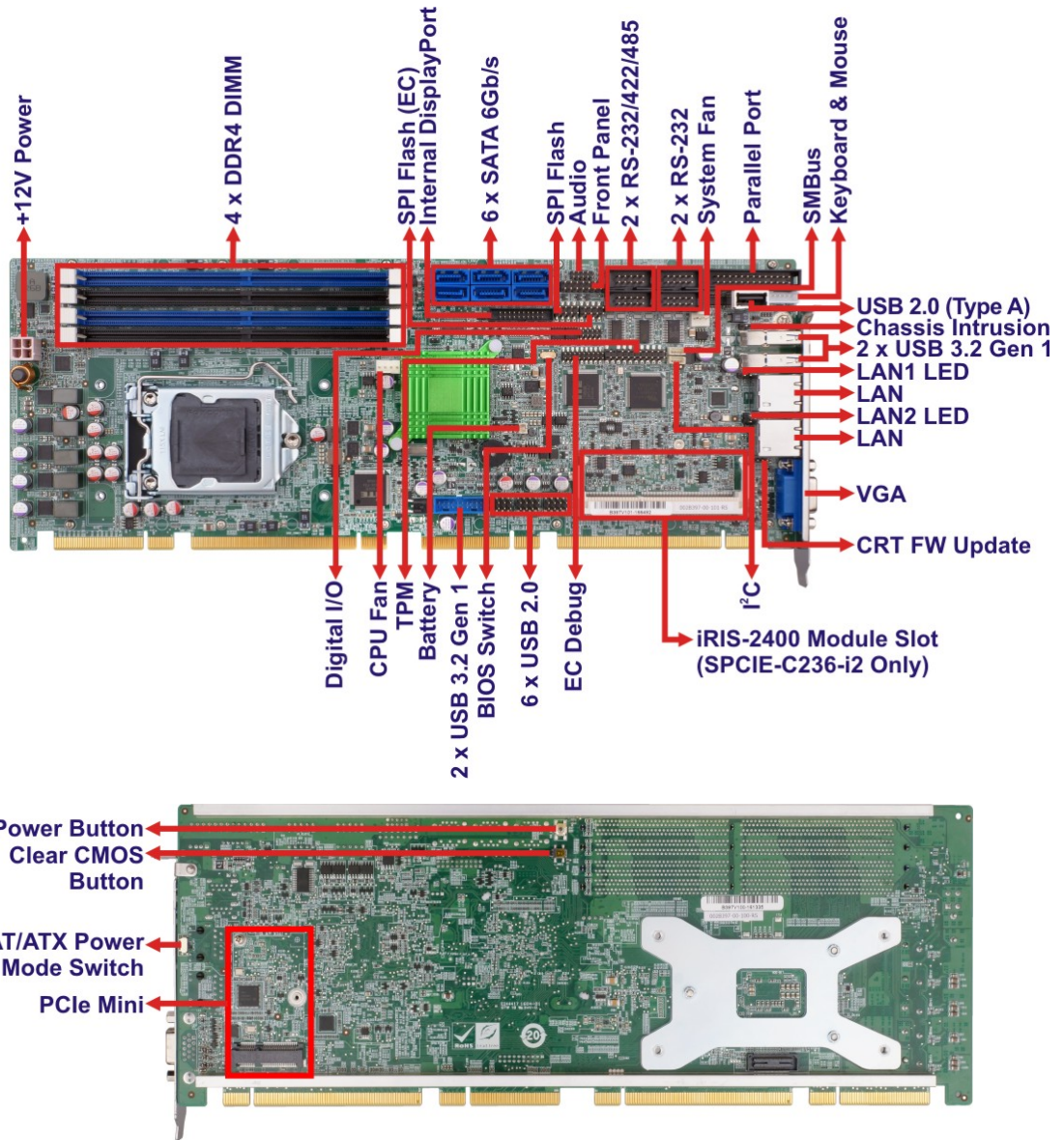
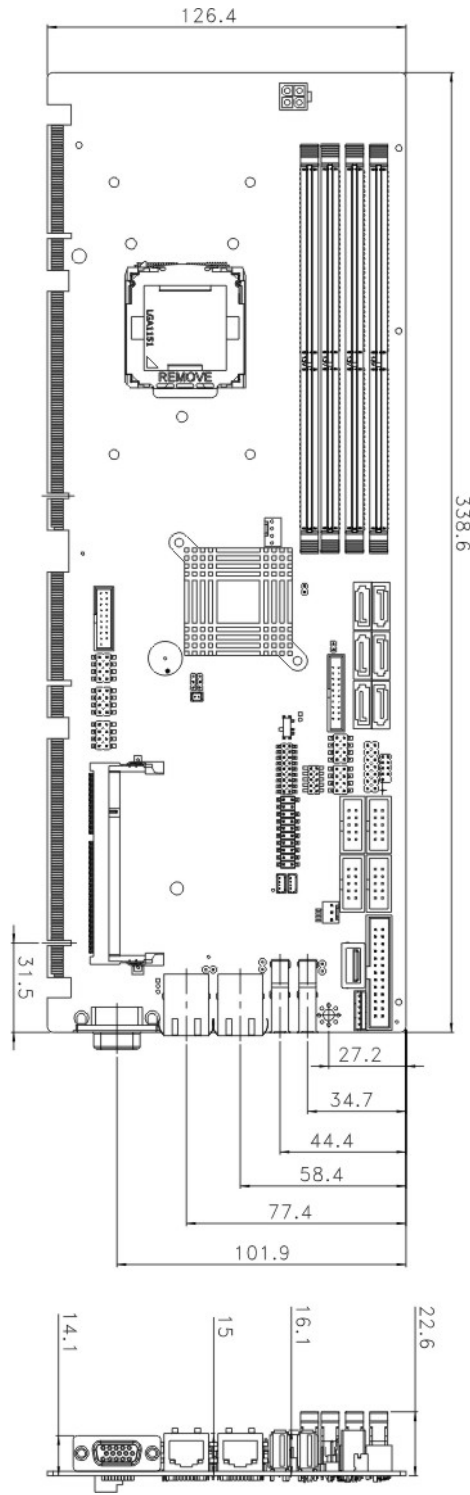

Figure 1-2: Connectors

**SPCIE-C236 Full-size PICMG 1.3 CPU Card**

**1.5 Dimensions**

The main dimensions of the SPCIE-C236 are shown in the diagram below.



**Figure 1-3: SPCIE-C236 Dimensions (mm)**



### 1.6 Data Flow

Figure 1-4 shows the data flow between the system chipset, the CPU and other components installed on the motherboard.

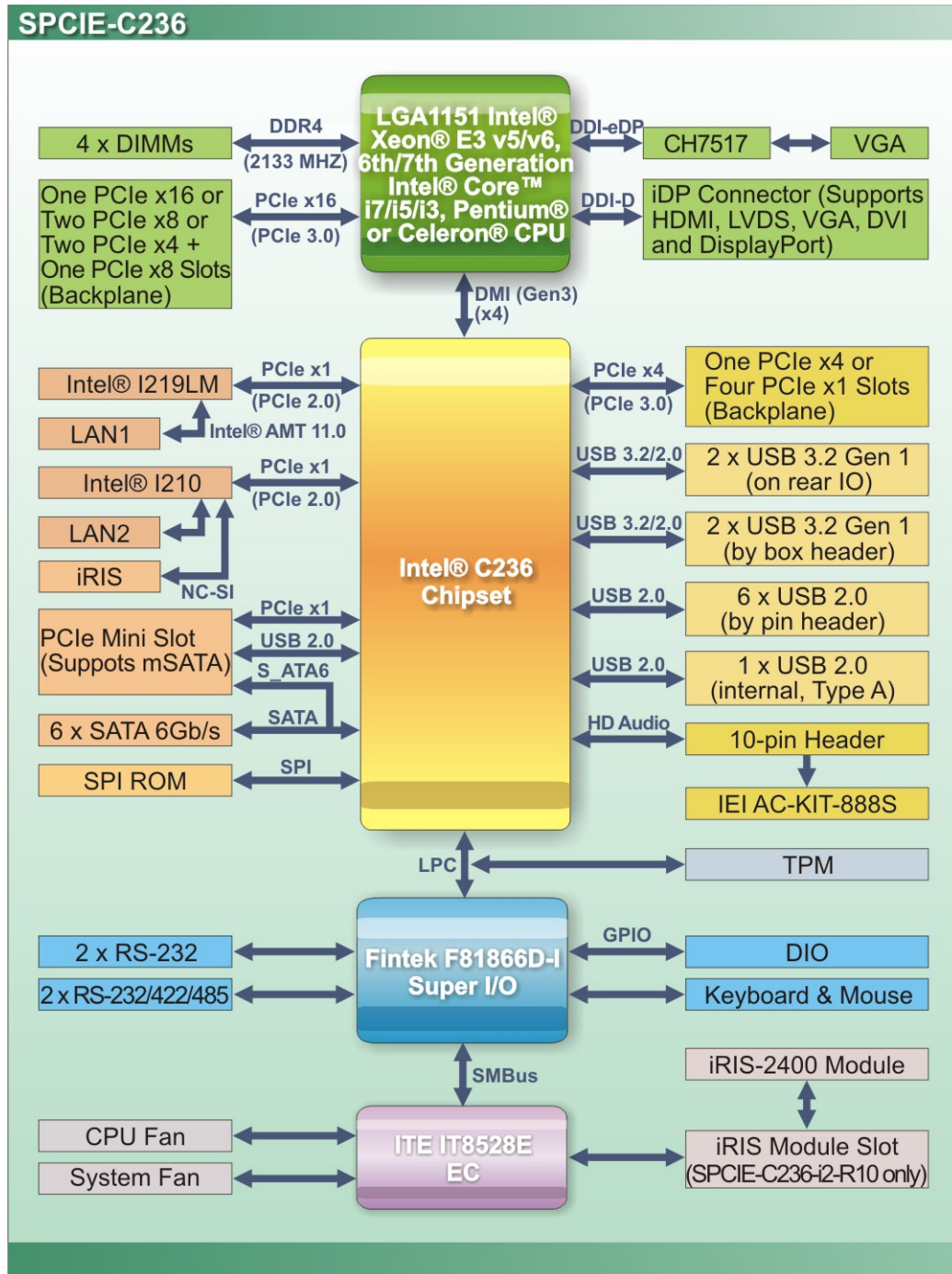

Figure 1-4: Data Flow Diagram

## SPCIE-C236 Full-size PICMG 1.3 CPU Card

### 1.7 Technical Specifications

The SPCIE-C236 technical specifications are listed below.

Specification/Model	SPCIE-C236
<b>Form Factor</b>	Full-size PICMG 1.3 CPU card
<b>CPU Supported</b>	LGA1151 Intel® Xeon® E3 v5/v6, 6th/7th generation Intel® Core™ i7/i5/i3, Pentium® or Celeron® CPU
<b>PCH</b>	Intel® C236
<b>Memory</b>	Four 288-pin 2133/1867 MHz dual-channel ECC/non-ECC unbuffered DDR4 SDRAM DIMMs supported (system max. 64 GB)
<b>Graphics Engine</b>	Intel® HD Graphics Gen9 engine supports DirectX 11/12, OpenCL 2.x and OpenGL 4.3/4.4 Decode/encode for HEVC, VP8, VP9, VDENC
<b>Display Output</b>	Supports dual independent display One VGA (via Chrontel CH7517, up to 1920x1200@60 Hz) One iDP interface for HDMI, LVDS, VGA, DVI and DisplayPort (up to 3840x2160@60 Hz)
<b>Ethernet Controllers</b>	<b>LAN1:</b> Intel® I219LM PCIe GbE controller with Intel® AMT 11.0 support <b>LAN2:</b> Intel® I210 PCIe GbE controller
<b>Audio</b>	Supports 7.1-channel HD audio by IEI AC-KIT-888S kit
<b>BIOS</b>	UEFI BIOS
<b>Expansions</b>	One full-size/half-size PCIe Mini card slot (supports mSATA, co-lay SATA port 6) 4 x PCI link via golden finger <b>16-lane PCIe link from CPU via golden finger:</b> Supports one PCIe x16, or two PCIe x8, or two PCIe x4 + one PCIe x8 slots on the backplane (configured via BIOS) <b>4-lane PCIe link from PCH via golden finger:</b> Supports four PCIe x1 slots or one PCIe x4 slot on the backplane (configured via BIOS switch)



<b>Super I/O Controller</b>	Fintek F81866D-I
<b>Embedded Controller</b>	ITE IT8528E
<b>Watchdog Timer</b>	Software programmable supports 1~255 sec. system reset
<b>I/O Interface Connectors</b>	
<b>Audio Connector</b>	One audio connector (10-pin header)
<b>Chassis Intrusion</b>	One 2-pin header
<b>Digital I/O</b>	8-bit digital I/O (10-pin header)
<b>Ethernet</b>	Two RJ-45 ports
<b>Fan</b>	One 4-pin CPU smart fan connector One 3-pin system smart fan connector
<b>Front Panel</b>	One 14-pin header (power LED, HDD LED, speaker, power button, reset button)
<b>I<sup>2</sup>C</b>	One 4-pin wafer connector
<b>iRIS (IEI Remote Intelligent System)</b>	One iRIS-2400 module slot (SPCIE-C236-i2 only)
<b>Internal DisplayPort</b>	One 20-pin box header
<b>Keyboard and Mouse</b>	One internal keyboard and mouse connector (6-pin wafer)
<b>LAN LED</b>	Two 2-pin headers for LAN1 LED and LAN2 LED
<b>Parallel Port</b>	One parallel port via internal 26-pin box header
<b>Serial ATA</b>	Six SATA 6Gb/s connectors (support RAID 0, 1, 5, 10)
<b>Serial Ports</b>	Two RS-232 via internal 10-pin box headers Two RS-232/422/485 via internal 10-pin box headers
<b>SMBus</b>	One 4-pin wafer connector
<b>TPM</b>	One via 20-pin header
<b>USB 2.0</b>	Six USB 2.0 ports by three internal pin headers One USB 2.0 port by internal Type A connector

## SPCIE-C236 Full-size PICMG 1.3 CPU Card

<b>USB 3.2 Gen 1</b>	<p>Two USB 3.2 Gen 1 (5Gb/s) ports on rear panel Two USB 3.2 Gen 1 (5Gb/s) ports via internal box header</p> <p>* The Windows® 7 installation media does not include native driver support for USB 3.2 Gen 1. In order to use the USB keyboard or mouse connected to a USB 3.2 Gen 1 port during OS installation, the user has to update the Windows® 7 installation image so that it contains USB 3.2 Gen 1 drivers. Please refer to Section 4.11 for detailed installation procedures.</p>
<b>Environmental and Power Specifications</b>	
<b>Power Supply</b>	5V/12V, AT/ATX power support
<b>Power Consumption</b>	5V@3.31A, 12V@6.97A, 3.3V@1.21A, 5VSB@0.16A (3.6 GHz Intel® Xeon® E3-1275 v5 CPU with four 16 GB 2133 MHz DDR4 memory)
<b>Operating Temperature</b>	-20°C ~ 60°C
<b>Storage Temperature</b>	-30°C ~ 70°C
<b>Operating Humidity</b>	5% ~ 95% (non-condensing)
<b>Physical Specifications</b>	
<b>Dimensions</b>	338 mm x 126 mm
<b>Weight (GW/NW)</b>	1000 g/420 g

Table 1-2: SPCIE-C236 Specifications

Chapter

**2**

# Packing List

---

## SPCIE-C236 Full-size PICMG 1.3 CPU Card

### 2.1 Anti-static Precautions

---



#### WARNING!

Static electricity can destroy certain electronics. Make sure to follow the ESD precautions to prevent damage to the product, and injury to the user.

---

Make sure to adhere to the following guidelines:

- **Wear an anti-static wristband:** Wearing an anti-static wristband can prevent electrostatic discharge.
- **Self-grounding:** Touch a grounded conductor every few minutes to discharge any excess static buildup.
- **Use an anti-static pad:** When configuring any circuit board, place it on an anti-static mat.
- **Only handle the edges of the PCB:** Don't touch the surface of the motherboard. Hold the motherboard by the edges when handling.

### 2.2 Unpacking Precautions

When the SPCIE-C236 is unpacked, please do the following:

- Follow the anti-static guidelines above.
- Make sure the packing box is facing upwards when opening.
- Make sure all the packing list items are present.





## 2.3 Packing List



**NOTE:**

If any of the components listed in the checklist below are missing, do not proceed with the installation. Contact the IEI reseller or vendor the SPCIE-C236 was purchased from or contact an IEI sales representative directly by sending an email to [sales@ieiworld.com](mailto:sales@ieiworld.com).

The SPCIE-C236 is shipped with the following components:

Quantity	Item and Part Number	Image
1	SPCIE-C236 CPU card	
1	SATA cable	
1	Mini jumper pack	
1	Standoff and screw (for half-size PCIe Mini card)	
1	Quick installation guide	









**Table 2-1: Packing List**









## SPCIE-C236 Full-size PICMG 1.3 CPU Card

### 2.4 Optional Items

The following are optional components which may be separately purchased:

Item and Part Number	Image
RS-232/422/485 cable, 230 mm, P=2.54 <b>(P/N: 32205-000702-100-RS)</b>	
PS/2 KB/MS Y-cable with bracket, 220mm <b>(P/N: 19800-000075-RS)</b>	
SATA power cable <b>(P/N: 32102-000100-200-RS)</b>	
LPT cable <b>(P/N: 32200-015100-RS)</b>	
7.1-channel HD audio kit with Realtek ALC888S audio codec supporting dual audio stream <b>(P/N: AC-KIT-888S-R10)</b>	
LGA1150 cooler kit (high-performance compatible, 95W) <b>(P/N: CF-1150SA-R10)</b>	
LGA1150 cooler kit (high-performance compatible, 65W) <b>(P/N: CF-1150SB-R11)</b>	
LGA1150 cooler kit (1U chassis compatible, 65W) <b>(P/N: CF-1150SC-R20)</b>	

Item and Part Number	Image
LGA1150 cooler kit (high-performance compatible, 95W) (P/N: CF-1150SE-R11)	 A black cooling fan mounted on a copper-colored metal base with a fan cable.
DisplayPort to HDMI converter board (for IEI iDP connector) (P/N: DP-HDMI-R10)	 A green printed circuit board with various electronic components and connectors.
DisplayPort to LVDS converter board (for IEI iDP connector) (P/N: DP-LVDS-R10)	 A green printed circuit board with various electronic components and connectors.
DisplayPort to VGA converter board (for IEI iDP connector) (P/N: DP-VGA-R10)	 A green printed circuit board with a blue VGA connector and other components.
DisplayPort to DVI-D converter board (for IEI iDP connector) (P/N: DP-DVI-R10)	 A green printed circuit board with a DVI-D connector and other components.
DisplayPort to DisplayPort converter board (for IEI iDP connector) (P/N: DP-DP-R10)	 A green printed circuit board with two DisplayPort connectors and a RoHS label.
SATA to IDE/CompactFlash® converter board (P/N: SAIDE-KIT01-R10)	 A green printed circuit board with a SATA connector and a CompactFlash slot.

**Table 2-2: Optional Items**

Chapter

**3**

# Connectors

---

### 3.1 Peripheral Interface Connectors

This chapter details all the peripheral interface connectors.

#### 3.1.1 SPCIE-C236 Layout

The figure below shows all the peripheral interface connectors.

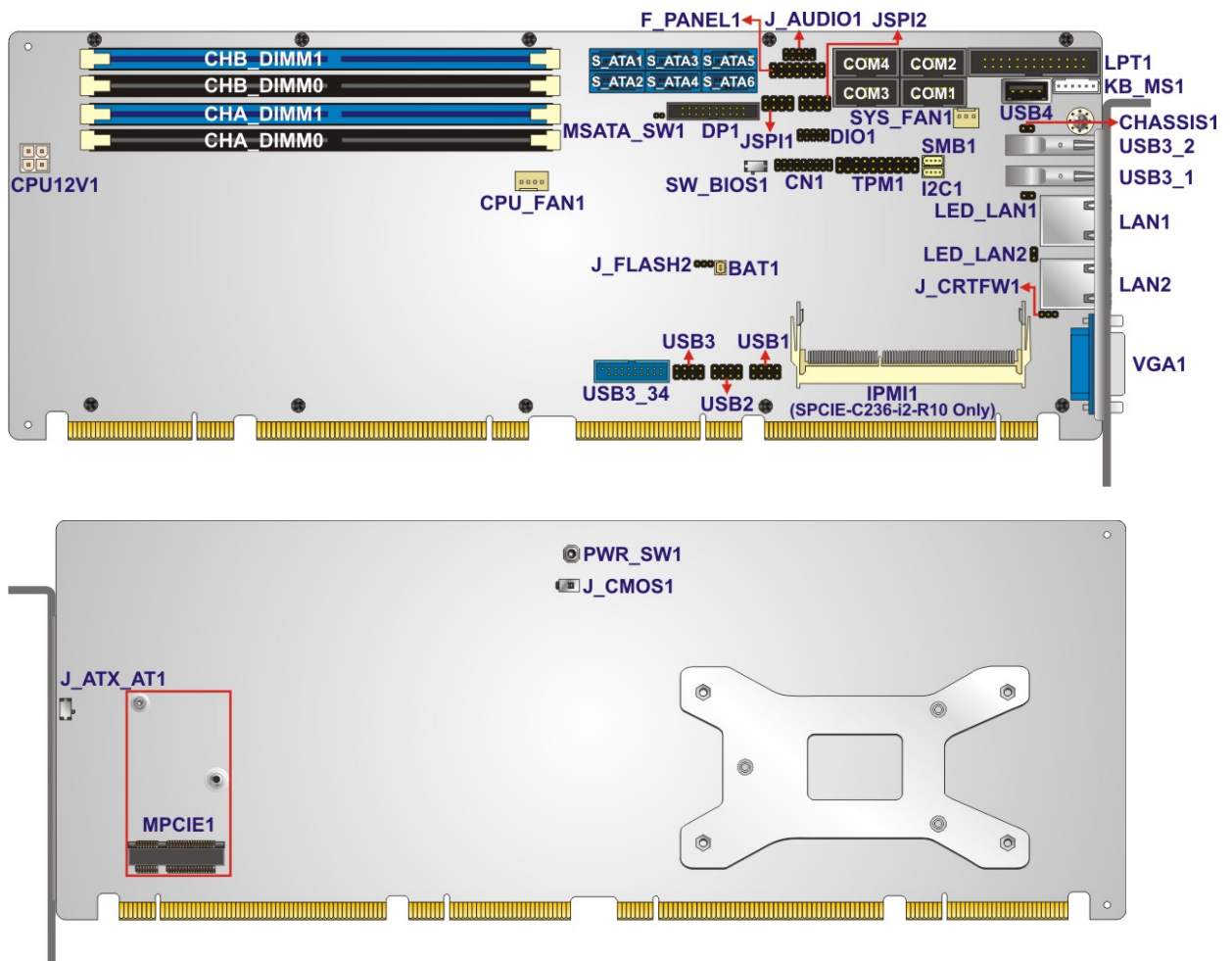

**Figure 3-1: Peripheral Interface Connectors**



## SPCIE-C236 Full-size PICMG 1.3 CPU Card

### 3.1.2 Peripheral Interface Connectors

The table below lists all the connectors on the board.

Connector	Type	Label
+12V ATX power supply connector	4-pin Molex power connector	CPU12V1
Audio kit connector	10-pin header	J_AUDIO1
Battery connector	2-pin wafer	BAT1
Chassis intrusion connector	2-pin header	CHASSIS1
CRT FW update	3-pin header	J_CRTFW1
DDR4 DIMM sockets	288-pin socket	CHA_DIMM0, CHA_DIMM1, CHB_DIMM0, CHB_DIMM1
Digital I/O connector	10-pin header	DIO1
EC debug connector	18-pin header	CN1
Fan connector (CPU)	4-pin wafer	CPU_FAN1
Fan connector (system)	3-pin wafer	SYS_FAN1
Front panel connector	14-pin header	F_PANEL1
I <sup>2</sup> C connector	4-pin wafer	I2C1
Internal DisplayPort connector	20-pin box header	DP1
iRIS-2400 module slot (SPCIE-C236-i2 only)	iRIS-2400 module slot	IPMI1
Keyboard and mouse connector	6-pin wafer	KB_MS1
LAN LED connectors	2-pin header	LED_LAN1, LED_LAN2
Parallel port connector	26-pin box header	LPT1
PCIe Mini slot	PCIe Mini slot	MPCIE1
Power button	Push button	PWR_SW1
RS-232 serial ports	10-pin box header	COM1, COM2



Connector	Type	Label
RS-232/422/485 serial ports	10-pin box header	COM3, COM4
SATA 6Gb/s drive connector	7-pin SATA connector	S_ATA1, S_ATA2, S_ATA3, S_ATA4, S_ATA5, S_ATA6,
SMBus connector	4-pin wafer	SMB1
SPI flash connector	8-pin header	JSPI1
SPI flash connector, EC	8-pin header	JSPI2
TPM connector	20-pin header	TPM1
USB 2.0 connectors	8-pin header	USB1, USB2, USB3
USB 2.0 connector (Type A)	Type A	USB4
USB 3.2 Gen 1 connector	19-pin box header	USB3_34

**Table 3-1: Peripheral Interface Connectors**

### 3.1.3 External Interface Panel Connectors

The table below lists the connectors on the external I/O panel.

Connector	Type	Label
Ethernet ports	RJ-45	LAN1, LAN2
USB 3.2 Gen 1 ports	USB Type-A	USB3_1, USB3_2
VGA connector	15-pin female	VGA1

**Table 3-2: External Peripheral Connectors**

## SPCIE-C236 Full-size PICMG 1.3 CPU Card

### 3.2 Internal Peripheral Connectors

The section describes all of the connectors on the SPCIE-C236.

#### 3.2.1 +12V ATX Power Connector

- CN Label:** CPU12V1
- CN Type:** 4-pin Molex power connector, p=4.2 mm
- CN Location:** See **Figure 3-2**
- CN Pinouts:** See **Table 3-3**

This connector provides power to the CPU.

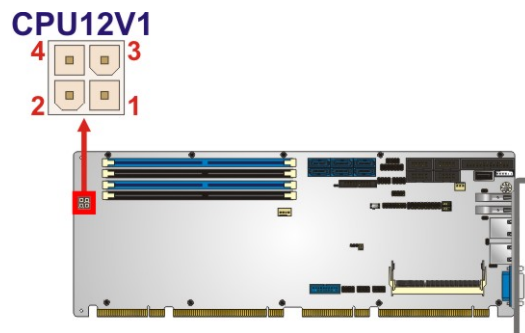

**Figure 3-2: +12V ATX Power Connector Pinout Location**

Pin	Description	Pin	Description
1	GND	2	GND
3	+12V	4	+12V

**Table 3-3: +12V ATX Power Connector Pinouts**

### 3.2.2 Audio Kit Connector

- CN Label:** J\_AUDIO1
- CN Type:** 10-pin header, p=2.00 mm
- CN Location:** See **Figure 3-3**
- CN Pinouts:** See **Table 3-4**

This connector allows connection to an external audio kit.

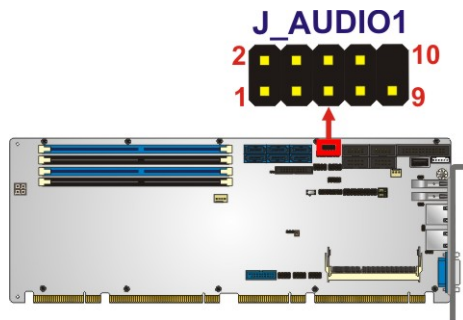

**Figure 3-3: Audio Connector Location**

Pin	Description	Pin	Description
1	HDA_SYNC	2	HDA_BIT_CLK
3	HDA_SDOUT	4	HDA_SPKR
5	HDA_SDIN	6	HDA_RST#
7	HDA_VCC	8	HDA_GND
9	HDA_+12V	10	HDA_GND

**Table 3-4: Audio Connector Pinouts**

## SPCIE-C236 Full-size PICMG 1.3 CPU Card

### 3.2.3 Battery Connector



**CAUTION:**

Risk of explosion if battery is replaced by an incorrect type. Only certified engineers should replace the on-board battery.

Dispose of used batteries according to instructions and local regulations.

- CN Label:** BAT1
- CN Type:** 2-pin wafer, p=1.25 mm
- CN Location:** See **Figure 3-4**
- CN Pinouts:** See **Table 3-5**

This is connected to the system battery. The battery provides power to the system clock to retain the time when power is turned off. **NOTE:** It is recommended to attach the RTC battery onto the system chassis in which the SPCIE-C236 is installed.

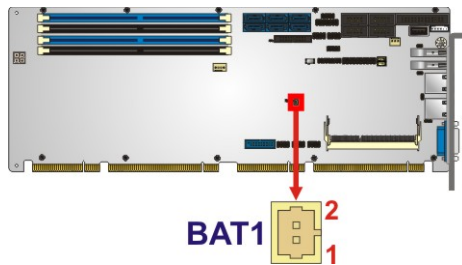

**Figure 3-4: Battery Connector Location**

Pin	Description
1	VBATT
2	GND

**Table 3-5: Battery Connector Pinouts**

**3.2.4 Chassis Intrusion Connector**

- CN Label:** CHASSIS1
- CN Type:** 2-pin header, p=2.54 mm
- CN Location:** See **Figure 3-5**
- CN Pinouts:** See **Table 3-6**

The chassis intrusion connector is for a chassis intrusion detection sensor or switch that detects if a chassis component is removed or replaced.

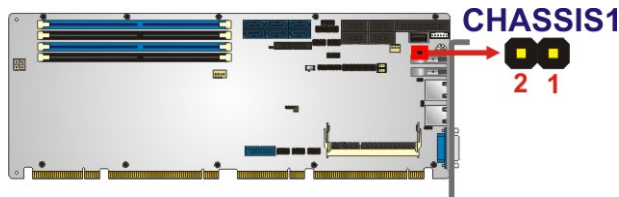

**Figure 3-5: Chassis Intrusion Connector Location**

Pin	Description
1	+3.3VSB
2	CHASSIS OPEN

**Table 3-6: Chassis Intrusion Connector Pinouts**



**SPCIE-C236 Full-size PICMG 1.3 CPU Card**

**3.2.5 CRT FW Update Connector**

- CN Label:** J\_CRTFW1
- CN Type:** 3-pin header, p=2.00 mm
- CN Location:** See **Figure 3-6**
- CN Pinouts:** See **Table 3-7**

The CRT FW update connector is used to update the CRT firmware.

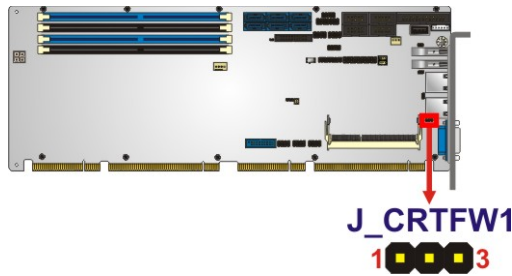

**Figure 3-6: CRT FW Update Connector Location**

Pin	Description
1	SPC
2	SPD
3	GND

**Table 3-7: CRT FW Update Connector Pinouts**

### 3.2.6 DDR4 DIMM Sockets

**CN Label:** CHA\_DIMM0, CHA\_DIMM1, CHB\_DIMM0, CHB\_DIMM1

**CN Type:** 288-pin DDR4 DIMM socket

**CN Location:** See **Figure 3-7**

The DIMM sockets are for DDR4 DIMM memory modules.



#### **CAUTION:**

For quad channel configuration, always install four identical memory modules that feature the same capacity, timings, voltage, number of ranks and the same brand.

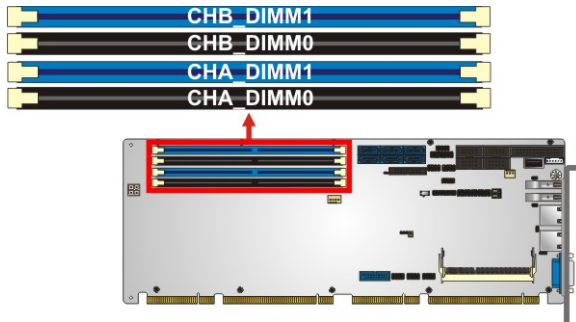

**Figure 3-7: DDR4 DIMM Socket Locations**

## SPCIE-C236 Full-size PICMG 1.3 CPU Card

### 3.2.7 Digital I/O Connector

- CN Label:** DIO1
- CN Type:** 10-pin header, p=2.00 mm
- CN Location:** See **Figure 3-8**
- CN Pinouts:** See **Table 3-8**

The digital I/O connector provides programmable input and output for external devices.

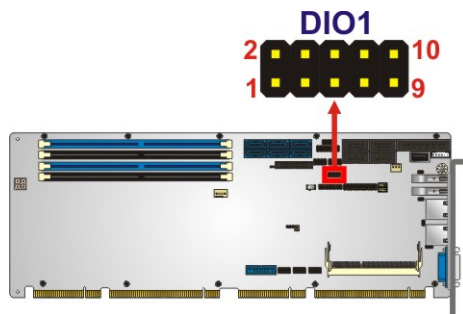

**Figure 3-8: Digital I/O Connector Location**

Pin	Description	Pin	Description
1	GND	2	VCC
3	Output 3	4	Output 2
5	Output 1	6	Output 0
7	Input 3	8	Input 2
9	Input 1	10	Input 0

**Table 3-8: Digital I/O Connector Pinouts**

### 3.2.8 EC Debug Connector

- CN Label:** CN1
- CN Type:** 18-pin header, p=2.00 mm
- CN Location:** See **Figure 3-9**
- CN Pinouts:** See **Table 3-9**

The EC debug connector is used for EC debug.

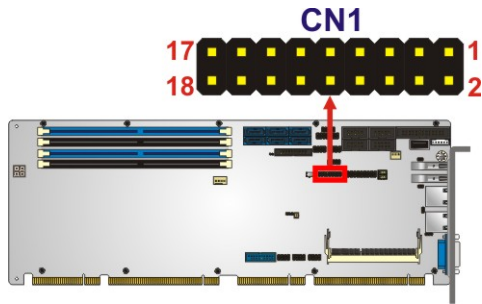

**Figure 3-9: EC Debug Connector Location**

Pin	Description	Pin	Description
1	EC_EPP_STB#	2	EC_EPP_AFD#
3	EC_EPP_PDO	4	NC
5	EC_EPP_PD1	6	EC_EPP_INIT#
7	EC_EPP_PD2	8	EC_EPP_SLIN#
9	EC_EPP_PD3	10	GND
11	EC_EPP_PD4	12	NC
13	EC_EPP_PD5	14	EC_EPP_BUSY
15	EC_EPP_PD6	16	EC_EPP_KSI5
17	EC_EPP_PD7	18	EC_EPP_KSI4

**Table 3-9: EC Debug Connector Pinouts**

**SPCIE-C236 Full-size PICMG 1.3 CPU Card**

**3.2.9 Fan Connector (CPU)**

- CN Label:** CPU\_FAN1
- CN Type:** 4-pin wafer, p=2.54 mm
- CN Location:** See **Figure 3-10**
- CN Pinouts:** See **Table 3-10**

The fan connector attaches to a CPU cooling fan.

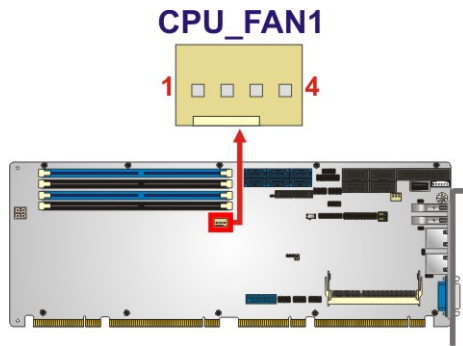

**Figure 3-10: CPU Fan Connector Location**

Pin	Description
1	GND
2	+12V
3	FANIO
4	PWM

**Table 3-10: CPU Fan Connector Pinouts**



**3.2.10 Fan Connectors (System)**

- CN Label:**        **SYS\_FAN1**
- CN Type:**        3-pin wafer, p=2.54 mm
- CN Location:**    See **Figure 3-11**
- CN Pinouts:**     See **Table 3-11**

The fan connector attaches to a system cooling fan.

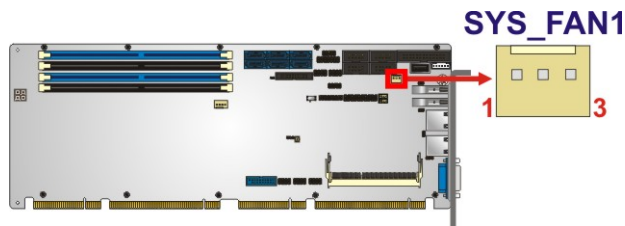

**Figure 3-11: System Fan Connector Location**

Pin	Description
1	FANIO
2	+12V (PWM)
3	GND

**Table 3-11: System Fan (SYS\_FAN1) Connector Pinouts**

## SPCIE-C236 Full-size PICMG 1.3 CPU Card

### 3.2.11 Front Panel Connector

- CN Label:** F\_PANEL1
- CN Type:** 14-pin header, p=2.54 mm
- CN Location:** See **Figure 3-12**
- CN Pinouts:** See **Table 3-12**

The front panel connector connects to the indicator LEDs and buttons on the computer's front panel.

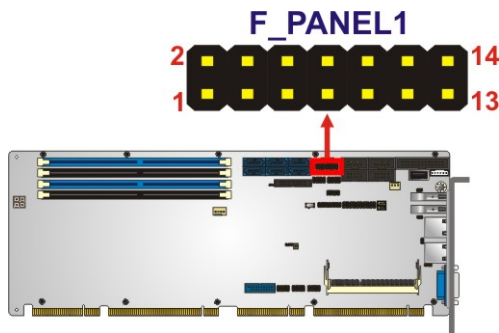

**Figure 3-12: Front Panel Connector Location**

Function	Pin	Description	Function	Pin	Description
Power LED	1	+5V	Speaker	2	BEEP_PWR
	3	NC	IPMI LED	4	IPMI ID_LED+
	5	GND		6	IPMI ID_LED-
Power Button	7	PWRBTN_SW#	Speaker	8	PC_BEEP
	9	GND		10	NC
HDD LED	11	+5V	Reset	12	EXTRST-
	13	SATA_LED#		14	GND

**Table 3-12: Front Panel Connector Pinouts**

### 3.2.12 I<sup>2</sup>C Connector

- CN Label:** I2C1
- CN Type:** 4-pin wafer, p=1.25 mm
- CN Location:** See **Figure 3-13**
- CN Pinouts:** See **Table 3-13**

The I<sup>2</sup>C connector is used to connect I<sup>2</sup>C-bus devices to the motherboard.

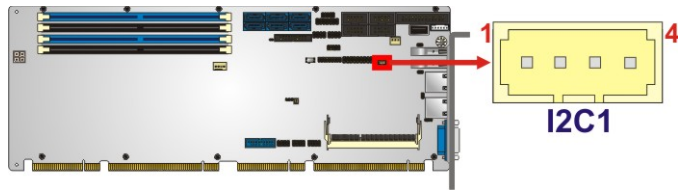

**Figure 3-13: I<sup>2</sup>C Connector Location**

Pin	Description
1	GND
2	I2C_DAT
3	I2C_CLK
4	+5V

**Table 3-13: I<sup>2</sup>C Connector Pinouts**

## SPCIE-C236 Full-size PICMG 1.3 CPU Card

### 3.2.13 Internal DisplayPort Connector

- CN Label:** DP1
- CN Type:** 20-pin box header, p=2.00 mm
- CN Location:** See **Figure 3-14**
- CN Pinouts:** See **Table 3-14**

The DisplayPort connector supports HDMI, LVDS, VGA, DVI and DisplayPort graphics interfaces with up to 3840x2160 resolutions.

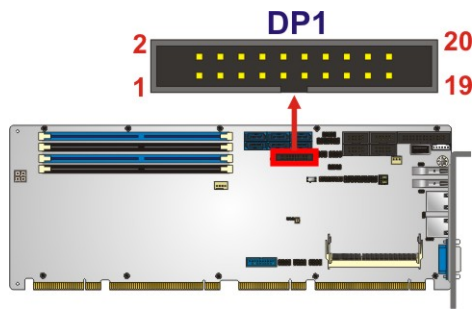

**Figure 3-14: Internal DisplayPort Connector Location**

Pin	Description	Pin	Description
1	HPD	11	LANE3N
2	AUXP	12	GND
3	GND	13	GND
4	AUXN	14	LANE0P
5	AUX_CTRL_DET_D	15	LANE1P
6	GND	16	LANE0N
7	GND	17	LANE1N
8	LANE2P	18	+3.3V
9	LANE3P	19	+5V
10	LANE2N	20	N/A

**Table 3-14: Internal DisplayPort Connector Pinouts**

**3.2.14 iRIS-2400 Module Slot (SPCIE-C236-i2 Only)**

<b>CN Label:</b>	<b>IPMI1</b>
<b>CN Type:</b>	iRIS-2400 module slot
<b>CN Location:</b>	See <b>Figure 3-15</b>

The iRIS-2400 module slot allows installation of the iRIS-2400 module.

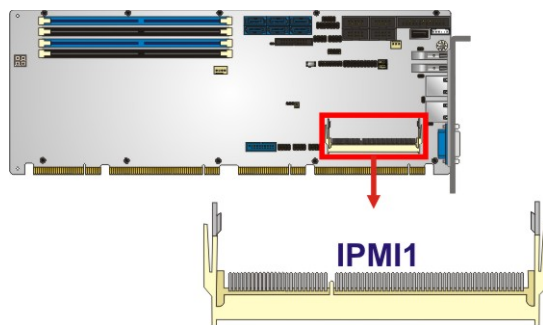

**Figure 3-15: iRIS-2400 Module Slot Location**

**WARNING:**

The iRIS-2400 module slot is designed to install the iRIS-2400 module only. DO NOT install other modules into the iRIS module slot. Doing so may cause damage to the SPCIE-C236.

---



**SPCIE-C236 Full-size PICMG 1.3 CPU Card**

**3.2.15 Keyboard and Mouse Connector**

- CN Label:** KB\_MS1
- CN Type:** 6-pin wafer, p=2.00 mm
- CN Location:** See **Figure 3-16**
- CN Pinouts:** See **Table 3-15**

The keyboard and mouse connector connects to a PS/2 Y-cable that can be connected to a PS/2 keyboard and mouse.

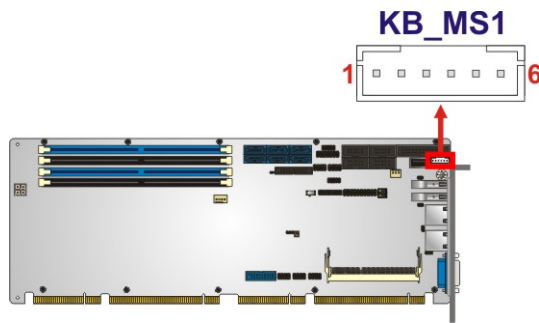

**Figure 3-16: Keyboard and Mouse Connector Location**

Pin	Description
1	VCC
2	Mouse Data
3	Mouse Clock
4	Keyboard Data
5	Keyboard Clock
6	GND

**Table 3-15: Keyboard and Mouse Connector Pinouts**

**3.2.16 LAN LED Connectors**

- CN Label:** LED\_LAN1, LED\_LAN2
- CN Type:** 2-pin header, p=2.54 mm
- CN Location:** See **Figure 3-17**
- CN Pinouts:** See **Table 3-16** and **Table 3-17**

The LAN LED connectors are used to connect to the LAN LED indicators on the chassis to indicate users the link activities of the two LAN ports.

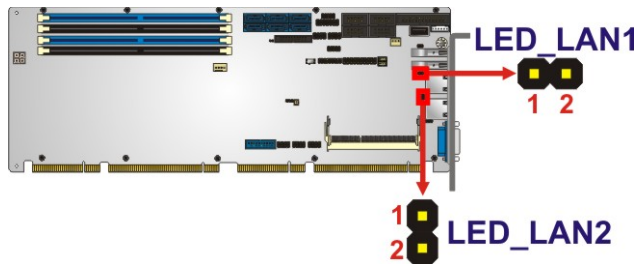

**Figure 3-17: LAN LED Connector Locations**

Pin	Description
1	+3.3V
2	LAN1_LED_LINK#_ACT

**Table 3-16: LAN1 LED Connector (LED\_LAN1) Pinouts**

Pin	Description
1	+3.3V
2	LAN2_LED_LINK#_ACT

**Table 3-17: LAN2 LED Connector (LED\_LAN2) Pinouts**

**SPCIE-C236 Full-size PICMG 1.3 CPU Card**

**3.2.17 Parallel Port Connector**

- CN Label:** LPT1
- CN Type:** 26-pin box header, p=2.54 mm
- CN Location:** See **Figure 3-18**
- CN Pinouts:** See **Table 3-18**

The parallel port connector connects to a parallel port connector interface or some other parallel port device such as a printer.

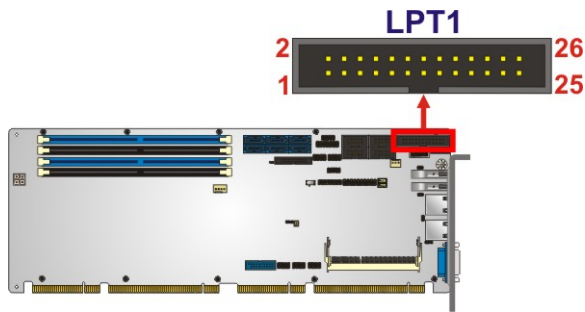

**Figure 3-18: Parallel Port Connector Location**

Pin	Description	Pin	Description
1	RSTROBE#	2	SIO_AFD#
3	RPD0	4	SIO_ERR#
5	RPD1	6	SIO_INIT#
7	RPD2	8	SIO_SLIN#
9	RPD3	10	GND
11	RPD4	12	GND
13	RPD5	14	GND
15	RPD6	16	GND
17	RPD7	18	GND
19	SIO_ACK#	20	GND
21	SIO_BUSY	22	GND
23	SIO_PE	24	GND
25	SIO_SLCT	26	N/C

**Table 3-18: Parallel Port Connector Pinouts**

**3.2.18 PCIe Mini Slot**

- CN Label:** MPCIE1
- CN Type:** PCIe Mini slot
- CN Location:** See **Figure 3-19**
- CN Pinouts:** See **Table 3-19**

The PCIe Mini slot is for installing a full-size/half-size PCIe Mini expansion card, such as an mSATA SSD or wireless LAN card.



**NOTE:**

If the user shorts the mSATA setup jumper (MSATA\_SW1) to force the system to enable mSATA device or an mSATA device is detected, the **S\_ATA6** connector will be disabled. Please refer to **Section 4.9.7** for detailed information.

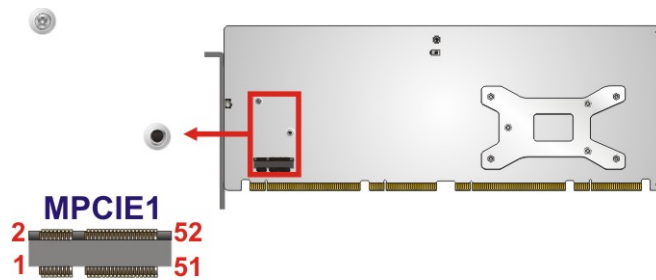

**Figure 3-19: PCIe Mini Slot Location**

Pin	Description	Pin	Description
1	PCIE_WAKE#	2	+3.3V
3	N/C	4	GND
5	N/C	6	1.5V
7	N/C	8	N/C
9	GND	10	N/C
11	MSATA_CLK#	12	N/C
13	MSATA_CLK	14	N/C
15	GND	16	N/C

## SPCIE-C236 Full-size PICMG 1.3 CPU Card

Pin	Description	Pin	Description
17	PLTRST_N	18	GND
19	N/C	20	+3.3V
21	GND	22	PLTRST_N
23	SATA_RX-/PCIE_RX-	24	+3.3V
25	SATA_RX+/PCIE_RX+	26	GND
27	GND	28	1.5V
29	GND	30	SMB_CLK
31	SATA_TX-/PCIE_TX-	32	SMB_DATA
33	SATA_TX+/PCIE_TX+	34	GND
35	GND	36	USB_DATA-
37	GND	38	USB_DATA+
39	+3.3V	40	GND
41	+3.3V	42	N/C
43	+3.3V	44	N/C
45	CLINK_CLK	46	N/C
47	CLINK_DATA	48	1.5V
49	CLINK_RST#	50	GND
51	MSATA_DET	52	+3.3V

**Table 3-19: PCIe Mini Slot Pinouts**

### 3.2.19 Power Button

**CN Label:** PWR\_SW1

**CN Type:** Push button

**CN Location:** See **Figure 3-20**

The on-board power button controls system power.



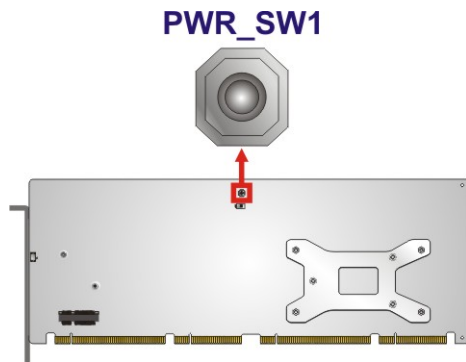
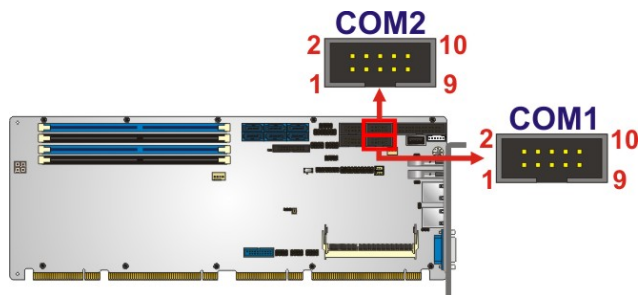

**Figure 3-20: Power Button Location**

### 3.2.20 RS-232 Serial Port Connectors

- CN Label:** COM1, COM2
- CN Type:** 10-pin box header, p=2.54 mm
- CN Location:** See **Figure 3-21**
- CN Pinouts:** See **Table 3-20**

Each of these connectors provides RS-232 connections.



**Figure 3-21: RS-232 Serial Port Connector Locations**

Pin	Description	Pin	Description
1	DCD	2	DSR
3	SIN	4	RTS
5	SOUT	6	CTS
7	DTR	8	RI
9	GND	10	GND

**Table 3-20: RS-232 Serial Port Connector Pinouts**

## SPCIE-C236 Full-size PICMG 1.3 CPU Card

### 3.2.21 RS-232/422/485 Serial Port Connectors

- CN Label:** COM3, COM4
- CN Type:** 10-pin box header, p=2.54 mm
- CN Location:** See **Figure 3-22**
- CN Pinouts:** See **Table 3-21**

Each of these connectors provides RS-232/422/485 connections.



**NOTE:**

The communication protocol of the serial ports is set through the BIOS menu in “Advanced → Super IO Configuration → Serial Port 3/4 Configuration”. Use the **Transfer Mode** BIOS option to configure the correspondent serial ports (refer to **Sections 5.3.4.1.3** and **5.3.4.1.4** for detailed information).

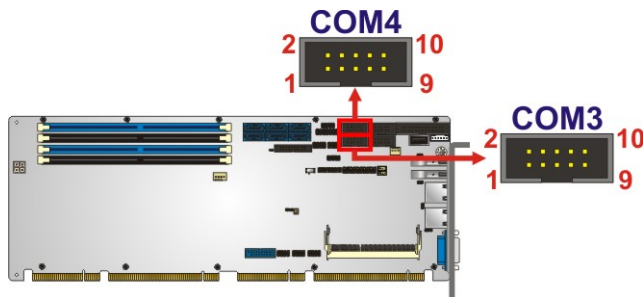
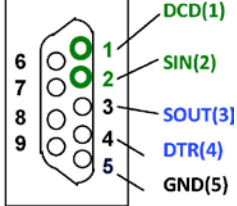
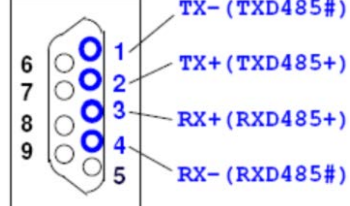
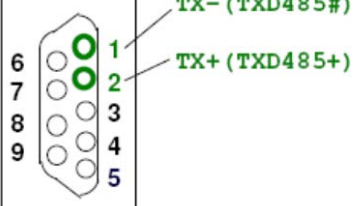

**Figure 3-22: RS-232/422/485 Serial Port Connector Locations**

Pin	Description	Pin	Description
1	DCD	2	DSR
3	SIN	4	RTS
5	SOUT	6	CTS
7	DTR	8	RI
9	GND	10	GND

**Table 3-21: RS-232/422/485 Serial Port Connector Pinouts**

The user may use the RS-232/422/485 cable to connect to a serial device. The pinouts of the DB-9 connector are listed below.

RS-232 Pinouts	RS-422 Pinouts	RS-485 Pinouts
		

**Table 3-22: DB-9 RS-232/422/485 Pinouts**

### 3.2.22 SATA 6Gb/s Drive Connector

**CN Label:** S\_ATA1, S\_ATA2, S\_ATA3, S\_ATA4, S\_ATA5, S\_ATA6

**CN Type:** 7-pin SATA drive connector

**CN Location:** See **Figure 3-23**

**CN Pinouts:** See **Table 3-23**

The SATA drive connectors can be connected to SATA drives and supports up to 6Gb/s data transfer rate.

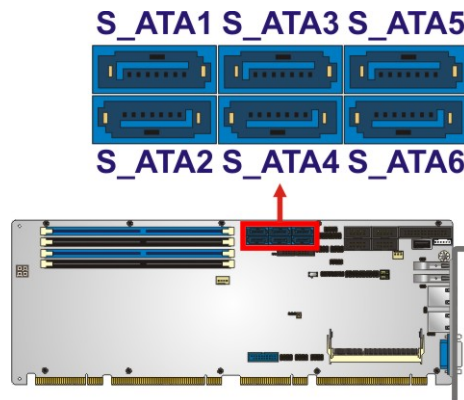

**Figure 3-23: SATA 6Gb/s Drive Connector Locations**

## SPCIE-C236 Full-size PICMG 1.3 CPU Card

Pin	Description	Pin	Description
1	GND	2	TX+
3	TX-	4	GND
5	RX-	6	RX+
7	GND		

**Table 3-23: SATA 6Gb/s Drive Connector Pinouts**



### NOTE:

If the user shorts the mSATA setup jumper (MSATA\_SW1) to force the system to enable mSATA device or an mSATA device is detected, the **S\_ATA6** connector will be disabled. Please refer to **Section 4.9.7** for detailed information.

### 3.2.23 SMBus Connector

- CN Label:** SMB1
- CN Type:** 4-pin wafer, p=1.25 mm
- CN Location:** See **Figure 3-24**
- CN Pinouts:** See **Table 3-24**

The SMBus (System Management Bus) connector provides low-speed system management communications.

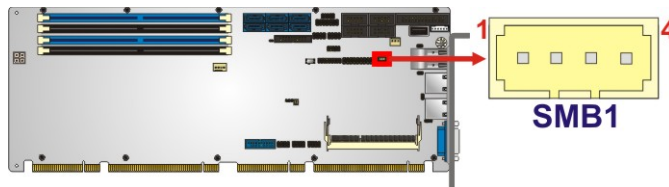

**Figure 3-24: SMBus Connector Location**

Pin	Description
1	GND
2	SMB_DATA
3	SMB_CLK
4	+5V

**Table 3-24: SMBus Connector Pinouts**

### 3.2.24 SPI Flash Connector

- CN Label:** JSPI1
- CN Type:** 8-pin header, p=2.54 mm
- CN Location:** See **Figure 3-25**
- CN Pinouts:** See **Table 3-25**

The SPI flash connector is used to flash the SPI ROM.

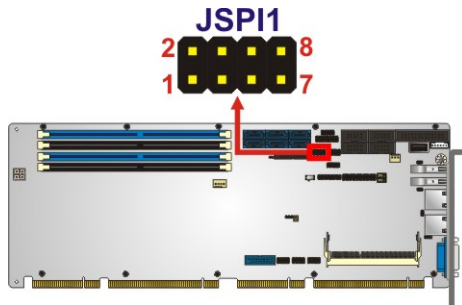

**Figure 3-25: SPI Flash Connector Location**

Pin	Description	Pin	Description
1	+3.3V	2	GND
3	SPI_CS	4	SPI_CLK_SW
5	SPI_SO_SW	6	SPI_SI_SW
7	NC	8	NC

**Table 3-25: SPI Flash Connector Pinouts**



**SPCIE-C236 Full-size PICMG 1.3 CPU Card**

**3.2.25 SPI Flash Connector, EC**

- CN Label:** JSPI2
- CN Type:** 8-pin header, p=2.54 mm
- CN Location:** See **Figure 3-26**
- CN Pinouts:** See **Table 3-26**

The SPI flash connector is used to flash the EC ROM.

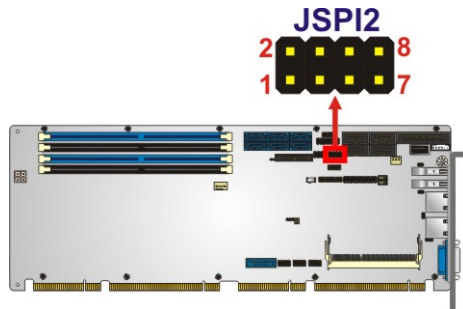

**Figure 3-26: SPI EC Flash Connector Location**

Pin	Description	Pin	Description
1	+3.3V	2	GND
3	SPI_CS	4	SPI_CLK
5	SPI_SO	6	SPI_SI
7	NC	8	NC

**Table 3-26: SPI EC Flash Connector Pinouts**

**3.2.26 TPM Connector**

- CN Label:** TPM1
- CN Type:** 20-pin header, p=2.54 mm
- CN Location:** See **Figure 3-27**
- CN Pinouts:** See **Table 3-27**

The TPM connector connects to a TPM module.

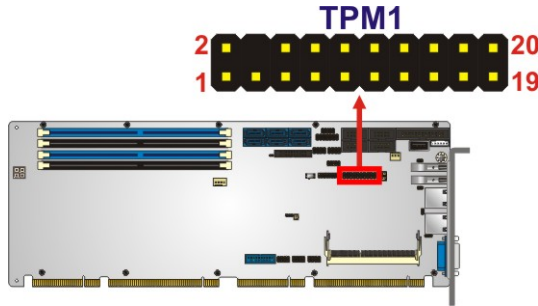

**Figure 3-27: TPM Connector Location**

Pin	Description	Pin	Description
1	LCLK	2	GND
3	LFRAME#	4	KEY
5	LRERST#	6	+5V
7	LAD3	8	LAD2
9	+3.3V	10	LAD1
11	LAD0	12	GND
13	SCL	14	SDA
15	SB3V	16	SERIRQ
17	GND	18	GLKRUN#
19	LPCPD#	20	LDRQ#

**Table 3-27: TPM Connector Pinouts**

**SPCIE-C236 Full-size PICMG 1.3 CPU Card**

**3.2.27 USB 2.0 Connectors**

- CN Label:** USB1, USB2, USB3
- CN Type:** 8-pin header, p=2.54 mm
- CN Location:** See **Figure 3-28**
- CN Pinouts:** See **Table 3-28**

The USB 2.0 connectors connect to USB 2.0 devices. Each pin header provides two USB 2.0 ports.

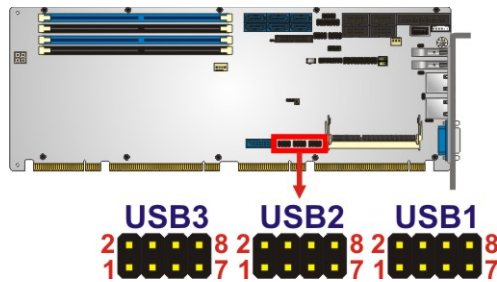

**Figure 3-28: USB 2.0 Connector Locations**

Pin	Description	Pin	Description
1	VCC	2	GND
3	USB_DATA-	4	USB_DATA+
5	USB_DATA+	6	USB_DATA-
7	GND	8	VCC

**Table 3-28: USB 2.0 Connector Pinouts**

**3.2.28 USB 2.0 Connector (Type A)**

- CN Label:** USB4
- CN Type:** USB Type A
- CN Location:** See **Figure 3-29**
- CN Pinouts:** See **Table 3-29**

The USB Type A connector connects to a USB 2.0/1.1 device.

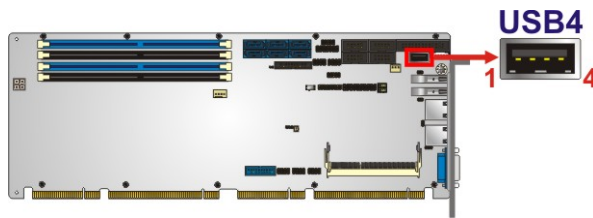

**Figure 3-29: USB 2.0 Connector (Type A) Pinout Location**

Pin	Description
1	VCC
2	DATA-
3	DATA+
4	GROUND

**Table 3-29: USB 2.0 Connector (Type A) Pinouts**

## SPCIE-C236 Full-size PICMG 1.3 CPU Card

### 3.2.29 USB 3.2 Gen 1 Connector

- CN Label:** USB3\_34
- CN Type:** 19-pin box header, p=2 mm
- CN Location:** See **Figure 3-30**
- CN Pinouts:** See **Table 3-30**

The USB 3.2 Gen 1 (5Gb/s) connector connects to USB 3.2 Gen 1 devices. This connector provides two USB 3.2 Gen 1 ports.

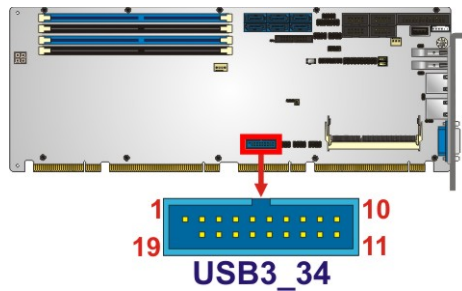

**Figure 3-30: USB 3.2 Gen 1 Connector Location**

Pin	Description	Pin	Description
1	VCC	11	USB_DATA+
2	USB3_RX-	12	USB_DATA-
3	USB3_RX+	13	GND
4	GND	14	USB3_TX+
5	USB3_TX-	15	USB3_TX-
6	USB3_TX+	16	GND
7	GND	17	USB3_RX+
8	USB_DATA-	18	USB3_RX-
9	USB_DATA+	19	VCC
10	NC		

**Table 3-30: USB 3.2 Gen 1 Connector Pinouts**



### 3.3 External Peripheral Interface Connector Panel

The figure below shows the external peripheral interface connector (EPIC) panel. The EPIC panel consists of the following:

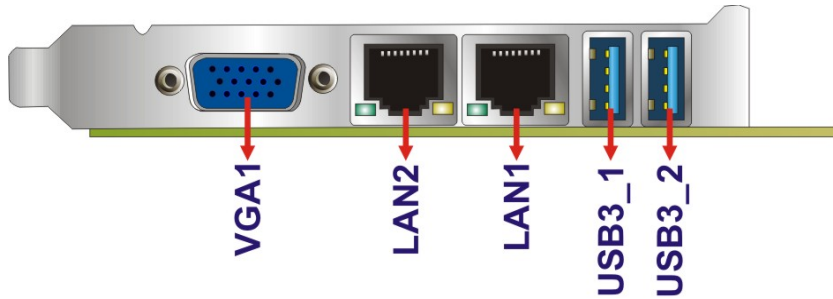

Figure 3-31: External Peripheral Interface Connector

#### 3.3.1 Ethernet Connectors

- CN Label:** LAN1, LAN2
- CN Type:** RJ-45
- CN Location:** See Figure 3-31
- CN Pinouts:** See Table 3-31

Each LAN connector connects to a local network.

Pin	Description	Pin	Description
1	LAN_MDI0P	5	LAN_MDI2P
2	LAN_MDI0N	6	LAN_MDI2N
3	LAN_MDI1P	7	LAN_MDI3P
4	LAN_MDI1N	8	LAN_MDI3N

Table 3-31: LAN Pinouts

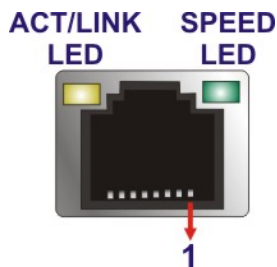

Figure 3-32: Ethernet Connector

## SPCIE-C236 Full-size PICMG 1.3 CPU Card

### 3.3.2 USB 3.2 Gen 1 Connectors

**CN Label:** USB3\_1, USB3\_2

**CN Type:** USB Type-A

**CN Location:** See **Figure 3-31**

**CN Pinouts:** See **Table 3-32**

There are two external USB 3.2 Gen 1 (5Gb/s) connectors on the SPCIE-C236.

Pin	Description	Pin	Description
1	VBUS	2	D-
3	D+	4	GND
5	STDA_SSRX_N	6	STDA_SSRX_P
7	GND_DRAIN	8	STDA_SSTX_N
9	STDA_SSTX_P		

**Table 3-32: USB 3.2 Gen 1 Port Pinouts**

**3.3.3 VGA Connector**

- CN Label:** VGA1
- CN Type:** 15-pin VGA
- CN Location:** See **Figure 3-31**
- CN Pinouts:** See **Table 3-33**

The 15-pin VGA connector connects to a monitor that accepts a standard VGA input.



**NOTE:**

The user has to connect the VGA connector to the monitor before system booting as the VGA output function is supported via the eDP to VGA converter.

Pin	Description	Pin	Description
1	RED	2	GREEN
3	BLUE	4	NC
5	GND	6	HOT PLUG DETECT
7	GND	8	GND
9	VCC	10	GND
11	NC	12	DDCDA
13	HSYNC	14	VSYNC
15	DDCCLK		

**Table 3-33: VGA Connector Pinouts**

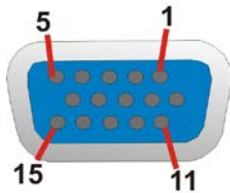

**Figure 3-33: VGA Connector**

Chapter

4

# Installation

---

## 4.1 Anti-static Precautions

---



### WARNING:

Failure to take ESD precautions during the installation of the SPCIE-C236 may result in permanent damage to the SPCIE-C236 and severe injury to the user.

---

Electrostatic discharge (ESD) can cause serious damage to electronic components, including the SPCIE-C236. Dry climates are especially susceptible to ESD. It is therefore critical that whenever the SPCIE-C236 or any other electrical component is handled, the following anti-static precautions are strictly adhered to.

- **Wear an anti-static wristband:** - Wearing a simple anti-static wristband can help to prevent ESD from damaging the board.
- **Self-grounding:**- Before handling the board touch any grounded conducting material. During the time the board is handled, frequently touch any conducting materials that are connected to the ground.
- **Use an anti-static pad:** When configuring the SPCIE-C236, place it on an anti-static pad. This reduces the possibility of ESD damaging the SPCIE-C236.
- **Only handle the edges of the PCB:-:** When handling the PCB, hold the PCB by the edges.

## 4.2 Installation Considerations

---



### NOTE:

The following installation notices and installation considerations should be read and understood before installation. All installation notices must be strictly adhered to. Failing to adhere to these precautions may lead to severe damage and injury to the person performing the installation.

---



## SPCIE-C236 Full-size PICMG 1.3 CPU Card



### **WARNING:**

The installation instructions described in this manual should be carefully followed in order to prevent damage to the components and injury to the user.

Before and during the installation please **DO** the following:

- Read the user manual:
  - The user manual provides a complete description of the SPCIE-C236 installation instructions and configuration options.
- Wear an electrostatic discharge cuff (ESD):
  - Electronic components are easily damaged by ESD. Wearing an ESD cuff removes ESD from the body and helps prevent ESD damage.
- Place the SPCIE-C236 on an anti-static pad:
  - When installing or configuring the motherboard, place it on an anti-static pad. This helps to prevent potential ESD damage.
- Turn all power to the SPCIE-C236 off:
  - When working with the SPCIE-C236, make sure that it is disconnected from all power supplies and that no electricity is being fed into the system.

Before and during the installation of the SPCIE-C236, **DO NOT:**

- Remove any of the stickers on the PCB board. These stickers are required for warranty validation.
- Use the product before verifying all the cables and power connectors are properly connected.
- Allow screws to come in contact with the PCB circuit, connector pins, or its components.

### 4.3 Socket LGA1151 CPU Installation

---

**WARNING:**

CPUs are expensive and sensitive components. When installing the CPU please be careful not to damage it in anyway. Make sure the CPU is installed properly and ensure the correct cooling kit is properly installed.

DO NOT touch the pins at the bottom of the CPU. When handling the CPU, only hold it on the sides.

---

To install the CPU, follow the steps below.

**Step 1:** Disengage the load lever by pressing the lever down and slightly outward to clear the retention tab. Fully open the lever. See **Figure 4-1**.

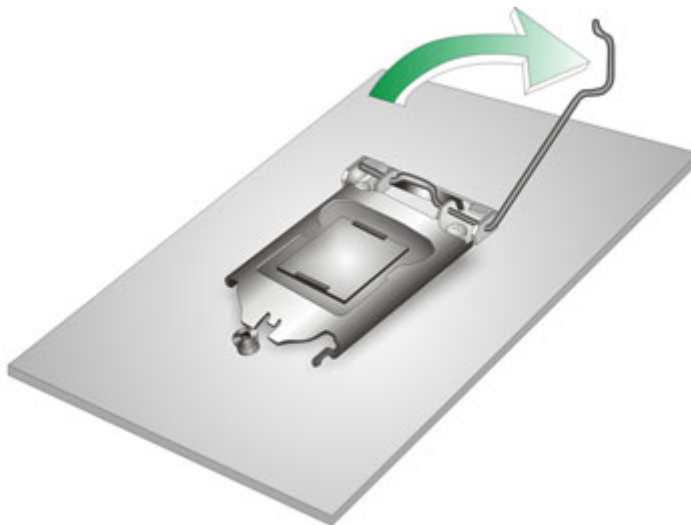

**Figure 4-1: Disengage the CPU Socket Load Lever**

**Step 2:** Open the socket and remove the protective cover. The black protective cover can be removed by pulling up on the tab labeled "Remove". See **Figure 4-2**.

## SPCIE-C236 Full-size PICMG 1.3 CPU Card

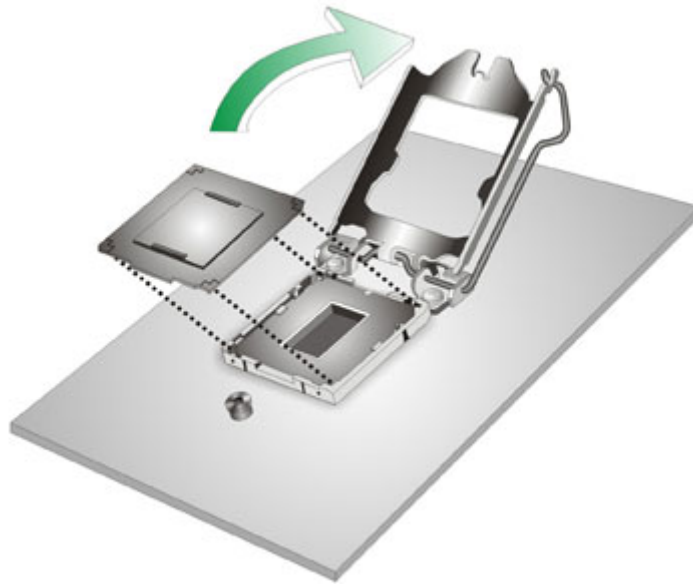

Figure 4-2: Remove Protective Cover

- Step 3:** **Inspect the CPU socket.** Make sure there are no bent pins and make sure the socket contacts are free of foreign material. If any debris is found, remove it with compressed air.
- Step 4:** **Orientate the CPU properly.** The contact array should be facing the CPU socket.



**WARNING:**

DO NOT touch the pins at the bottom of the CPU. When handling the CPU, only hold it on the sides.

- Step 5:** **Correctly position the CPU.** Match the Pin 1 mark with the cut edge on the CPU socket.
- Step 6:** **Align the CPU pins.** Locate pin 1 and the two orientation notches on the CPU. Carefully match the two orientation notches on the CPU with the socket alignment keys.

**Step 7: Insert the CPU.** Gently insert the CPU into the socket. If the CPU pins are properly aligned, the CPU should slide into the CPU socket smoothly. See **Figure 4-3**.

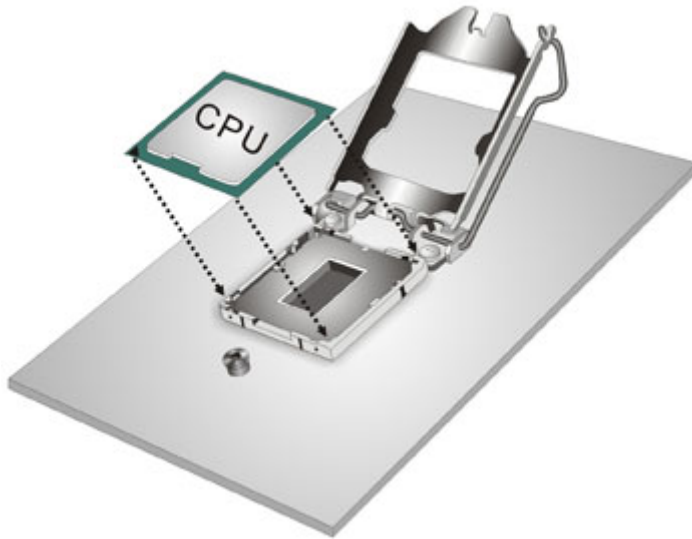

**Figure 4-3: Insert the Socket LGA1151 CPU**

**Step 8: Close the CPU socket.** Close the load plate and pull the load lever back a little to have the load plate be able to secure to the knob. Engage the load lever by pushing it back to its original position (**Figure 4-4**). There will be some resistance, but will not require extreme pressure.

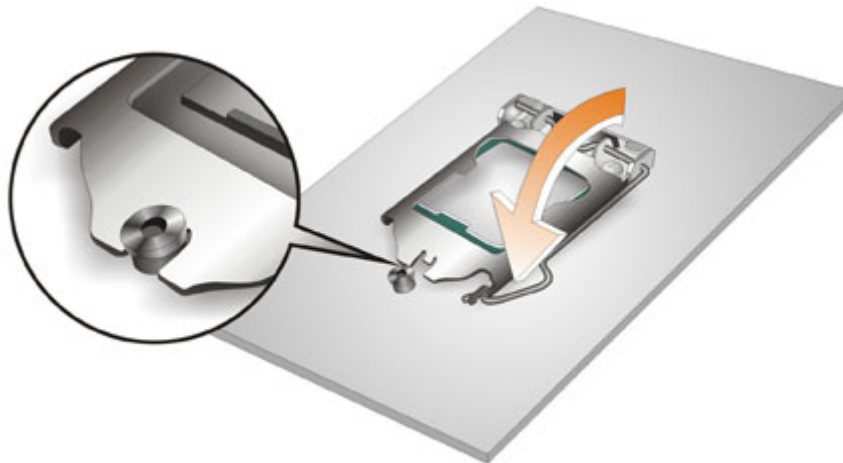

**Figure 4-4: Close the Socket LGA1151**

## SPCIE-C236 Full-size PICMG 1.3 CPU Card

**Step 9:** Connect the 12 V power to the board. Connect the 12 V power from the power supply to the board.

### 4.4 Socket LGA1151 Cooling Kit Installation

---



**WARNING:**

**DO NOT** attempt to install a push-pin cooling fan.

The pre-installed support bracket prevents the board from bending and is **ONLY** compatible with captive screw type cooling fans.

---

The cooling kit can be bought from IEI. The cooling kit has a heat sink and fan.

---



**WARNING:**

Do not wipe off (accidentally or otherwise) the pre-sprayed layer of thermal paste on the bottom of the heat sink. The thermal paste between the CPU and the heat sink is important for optimum heat dissipation.

---

To install the cooling kit, follow the instructions below.

**Step 1:** A cooling kit bracket is pre-installed on the rear of the motherboard. See **Figure 4-5**.



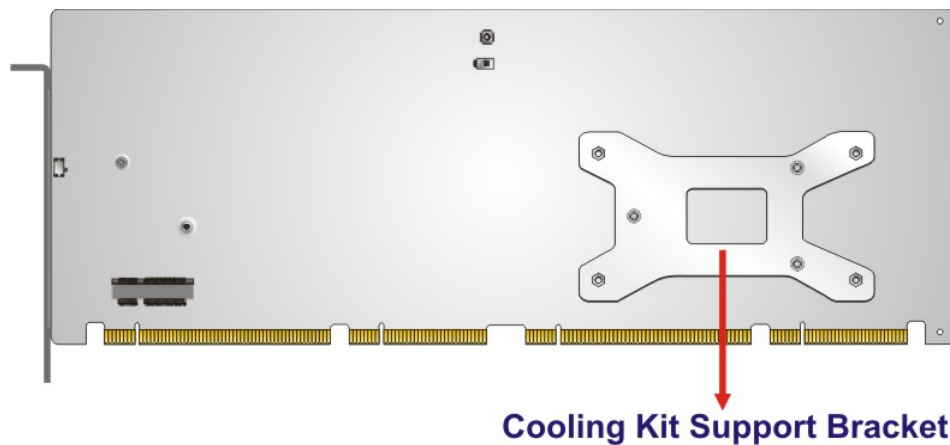

Figure 4-5: Cooling Kit Support Bracket

- Step 2:** Place the cooling kit onto the socket LGA1151 CPU. Make sure the CPU cable can be properly routed when the cooling kit is installed.
- Step 3:** Mount the cooling kit. Gently place the cooling kit on top of the CPU. Make sure the four threaded screws on the corners of the cooling kit properly pass through the holes of the cooling kit bracket.
- Step 4:** Tighten the screws. Use a screwdriver to tighten the four screws. In a diagonal pattern, tighten each screw a few turns then move to the next one, until they are all secured. Do not overtighten the screws.
- Step 5:** Connect the fan cable. Connect the cooling kit fan cable to the CPU fan connector on the SPCIE-C236. Carefully route the cable and avoid heat generating chips and fan blades.

## SPCIE-C236 Full-size PICMG 1.3 CPU Card

### 4.5 DIMM Installation

To install a DIMM, please follow the steps below and refer to **Figure 4-6**.



#### CAUTION:

For quad channel configuration, always install four identical memory modules that feature the same capacity, timings, voltage, number of ranks and the same brand.

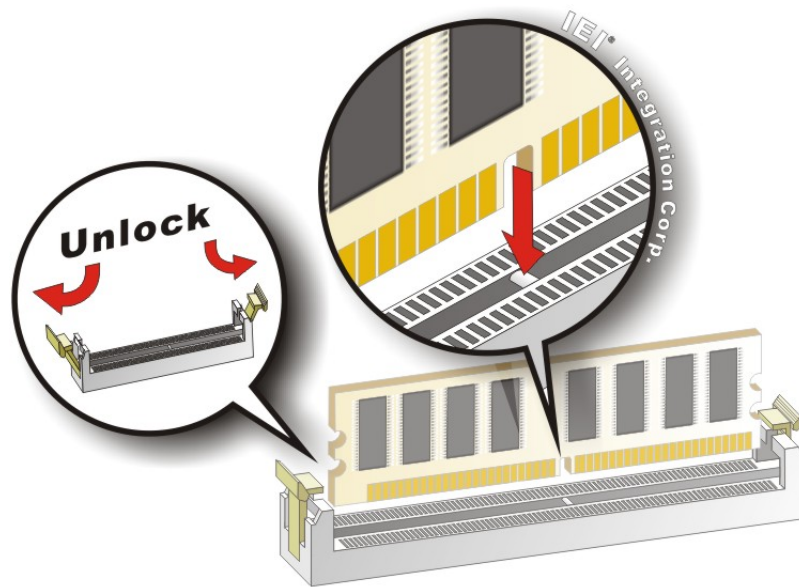

**Figure 4-6: DIMM Installation**

- Step 1:** **Open the DIMM socket handles.** Open the two handles outwards as far as they can. See **Figure 4-6**.
- Step 2:** **Align the DIMM with the socket.** Align the DIMM so the notch on the memory lines up with the notch on the memory socket. See **Figure 4-6**.
- Step 3:** **Insert the DIMM.** Once aligned, press down until the DIMM is properly seated. Clip the two handles into place. See **Figure 4-6**.

**Step 4: Removing a DIMM.** To remove a DIMM, push both handles outward. The memory module is ejected by a mechanism in the socket.

## 4.6 iRIS-2400 Module Installation (Optional)



### WARNING:

The iRIS-2400 module slot is designed to install the IEI iRIS-2400 IPMI 2.0 module only. DO NOT install other modules into the iRIS module slot. Doing so may cause damage to the SPCIE-C236.

To install the iRIS-2400 module, please follow the steps below and refer to **Figure 4-7**.

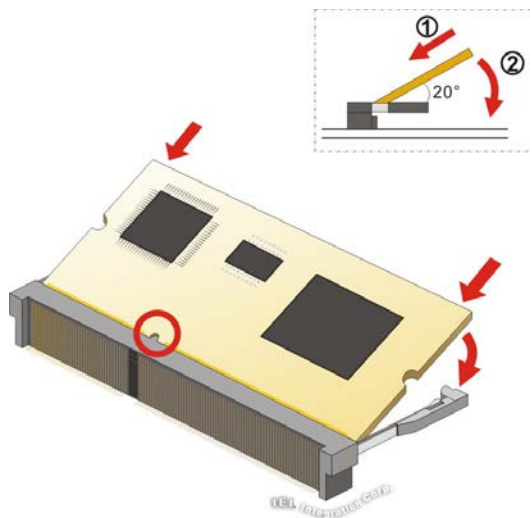

**Figure 4-7: iRIS-2400 Module Installation**

- Step 1:** Locate the IPMI module slot. Place the SPCIE-C236 on an anti-static pad.
- Step 2:** Align the iRIS-2400 module with the iRIS module slot. Align the notch on the module with the notch on the iRIS module slot.
- Step 3:** Insert the iRIS-2400 module. Push the module in at a 20° angle (**Figure 4-7**).
- Step 4:** Seat the iRIS-2400 module. Gently push downwards and the arms clip into place (**Figure 4-7**).

## SPCIE-C236 Full-size PICMG 1.3 CPU Card

### 4.7 Full-size PCIe Mini Card Installation

The PCIe Mini card slot allows installation of either a full-size or half-size PCIe Mini card. To install a full-size PCIe Mini card, please follow the steps below.

**Step 1:** Locate the PCIe Mini card slot. See Chapter 3.

**Step 2:** Remove the retention screw. Remove the retention screw as shown in Figure 4-8.

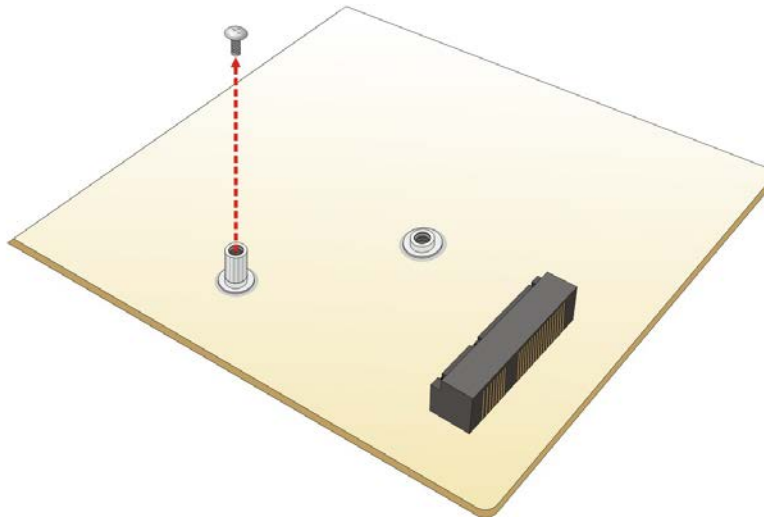

Figure 4-8: Removing the Retention Screw

**Step 3:** Insert into the socket at an angle. Line up the notch on the card with the notch on the slot. Slide the PCIe Mini card into the socket at an angle of about 20° (Figure 4-9).

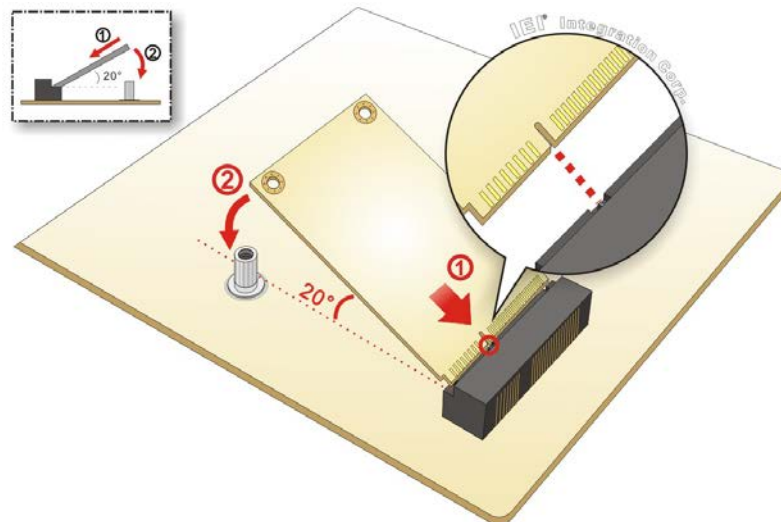

Figure 4-9: Inserting the Full-size PCIe Mini Card into the Slot at an Angle



**Step 4:** Secure the full-size PCIe Mini card. Secure the full-size PCIe Mini card with the retention screw previously removed (Figure 4-10).

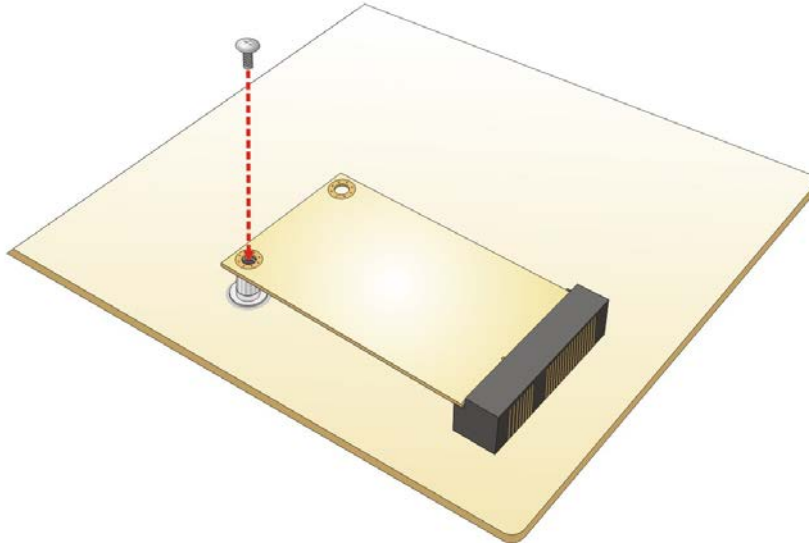

Figure 4-10: Securing the Full-size PCIe Mini Card

## 4.8 Half-size PCIe Mini Card Installation

The PCIe Mini card slot allows installation of either a full-size or half-size PCIe Mini card. To install a half-size PCIe Mini card, please follow the steps below.

**Step 1:** Locate the PCIe Mini card slot. See Chapter 3.

**Step 2:** Install the standoff to the screw hole for the half-size PCIe Mini card. Install the supplied standoff to the screw hole for the half-size PCIe Mini card (Figure 4-11).



## SPCIE-C236 Full-size PICMG 1.3 CPU Card

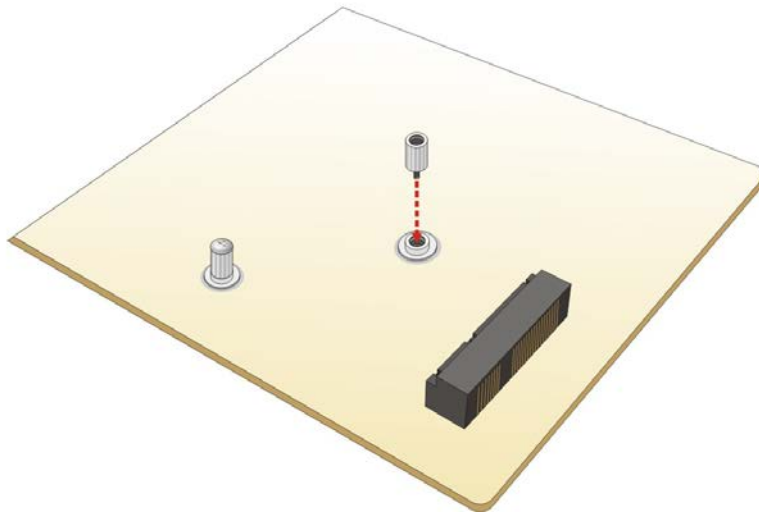

Figure 4-11: Installing the Standoff

**Step 3:** Insert into the socket at an angle. Line up the notch on the card with the notch on the slot. Slide the PCIe Mini card into the slot at an angle of about 20° (Figure 4-12).

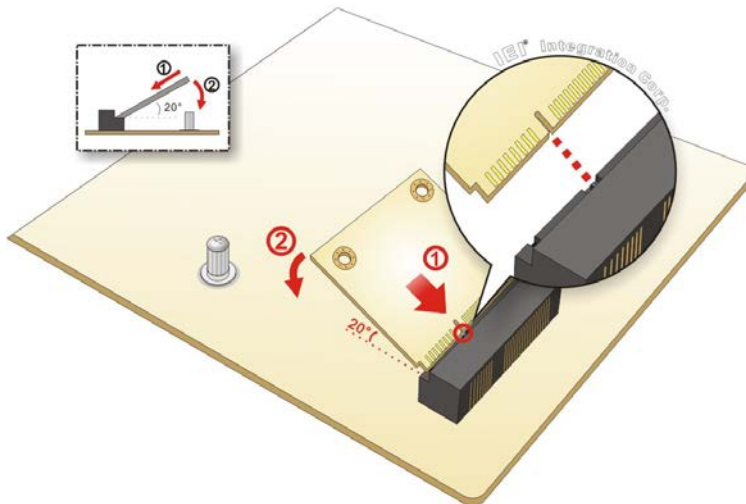
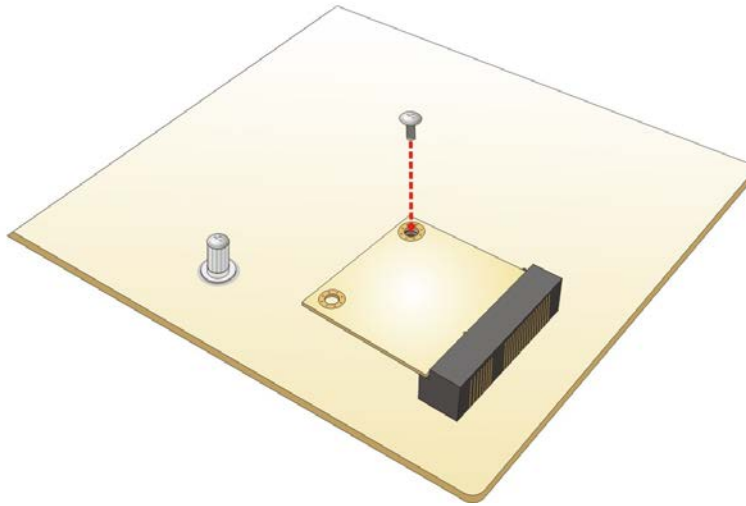

Figure 4-12: Inserting the Half-size PCIe Mini Card into the Slot at an Angle

**Step 4:** Secure the half-size PCIe Mini card. Secure the half-size PCIe Mini card with the supplied retention screw (Figure 4-13).



**Figure 4-13: Securing the Half-size PCIe Mini Card**

## 4.9 System Configuration

The system configuration should be performed before installation.

### 4.9.1 AT/ATX Power Mode Setting

The AT and ATX power mode selection is made through the AT/ATX power mode switch which is shown in **Figure 4-14**.

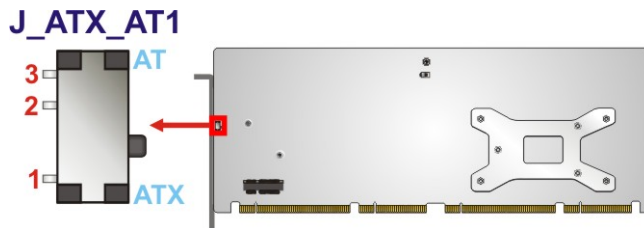

**Figure 4-14: AT/ATX Power Mode Switch Location**

Setting	Description
1-2 (down)	ATX power mode (default)
2-3 (up)	AT power mode

**Table 4-1: AT/ATX Power Mode Switch Settings**

## SPCIE-C236 Full-size PICMG 1.3 CPU Card

### 4.9.2 Clear CMOS Button

To reset the BIOS, remove the on-board battery and press the clear CMOS button for three seconds or more. The clear CMOS button location is shown in **Figure 4-15**.

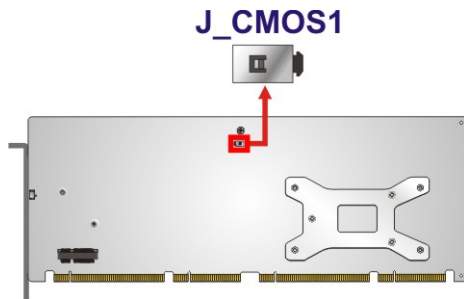

**Figure 4-15: Clear CMOS Button Location**

### 4.9.3 PCIe x4 Channel Mode Setup

The user can select to use either one PCIe x4 slot or four PCIe x1 slots on the backplane via the BIOS switch. Refer to below table for the BIOS switch settings.

Setting	Description
1-2 (BIOS1)	Sets the PCIe x4 link width as four PCIe x1 slots (default)
2-3 (BIOS2)	Sets the PCIe x4 link width as one PCIe x4 slot

**Table 4-2: BIOS Switch Settings**

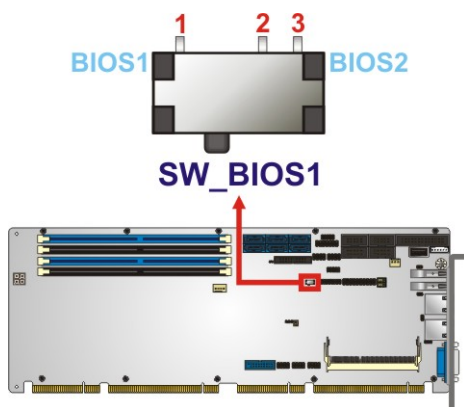

**Figure 4-16: BIOS Switch Location**

To switch BIOS1 to BIOS2 or BIOS2 to BIOS1 successfully, please follow the steps below.

- Step 1:** Unplug the system power cord.
- Step 2:** Switch BIOS1 to BIOS2 or BIOS2 to BIOS1 by moving the BIOS switch to BIOS1 or BIOS2 position as shown in **Figure 4-16**.
- Step 3:** Remove the on-board battery, and then reinstall it.
- Step 4:** Clear CMOS by pressing the clear CMOS button for three seconds or more.
- Step 5:** Perform the system booting.



#### NOTE:

The user can check which BIOS is being used from the **BIOS Number** item in the **Main BIOS menu (BIOS Menu 1)**.

### 4.9.4 PCIe x16 Channel Mode Setup

The SPCIE-C236 supports one PCIe x16 interface on the backplane. The PCIe x16 channel mode setup is made through the BIOS menu in “Chipset → System Agent (SA) Configuration → PEG Port Configuration”. Use the **PEG Link Width Configuration** BIOS option to configure the PCIe x16 channel mode.

Options	Description
1x16	Sets the PCIe x16 link width as one PCIe x16 slot (default)
2x8	Sets the PCIe x16 link width as two PCIe x8 slots
1x8, 2x4	Sets the PCIe x16 link width as one PCIe x8 and two PCIe x4

**Table 4-3: PCIe x16 Channel Mode Setup**

Please refer to **Section 5.4.1.2** for detailed information.

## SPCIE-C236 Full-size PICMG 1.3 CPU Card

### 4.9.5 Flash Descriptor Security Override Jumper

The flash descriptor security override jumper (J\_FLASH2) allows to enable or disable the ME firmware update. Refer to **Table 4-4** and **Figure 4-17** for the jumper location and settings.

Setting	Description
Short 1-2	Disabled (default)
Short 2-3	Enabled

**Table 4-4: Flash Descriptor Security Override Jumper Settings**

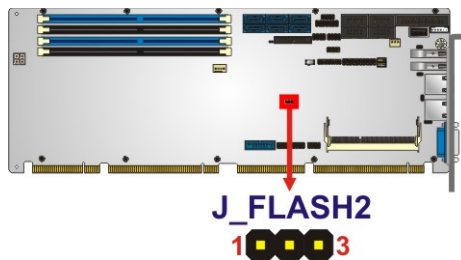

**Figure 4-17: Flash Descriptor Security Override Jumper Location**

To update the ME firmware, please follow the steps below.

- Step 1:** Before turning on the system power, short pin 2-3 of the flash descriptor security override jumper.
- Step 2:** Update the BIOS and ME firmware, and then turn off the system power.
- Step 3:** Remove the metal clip on the flash descriptor security override jumper or return to its default setting (short pin 1-2).
- Step 4:** Restart the system. The system will reboot 2 ~ 3 times to complete the ME firmware update.



### 4.9.6 USB Power Selection

The USB power selection is made through the BIOS menu in “Chipset → PCH-IO Configuration”. Use the **USB Power SW1** and the **USB Power SW2** BIOS options to configure the correspondent USB ports (see **Table 4-5**) and refer to **Table 4-6** to select the USB power source.

BIOS Options	Configured USB Ports
USB Power SW1	USB3_1 (external USB 3.2 Gen 1 port) USB3_2 (external USB 3.2 Gen 1 port) USB4 (internal USB 2.0 port, Type A)
USB Power SW2	USB1 (internal USB 2.0 ports) USB2 (internal USB 2.0 ports) USB3 (internal USB 2.0 ports) USB3_34 (internal USB 3.2 Gen 1 ports)

**Table 4-5: BIOS Options and Configured USB Ports**

Options	Description
+5V DUAL	+5V dual (default)
+5V	+5V

**Table 4-6: USB Power Source Setup**

Please refer to **Section 5.4.2** for BIOS setup.

## SPCIE-C236 Full-size PICMG 1.3 CPU Card

### 4.9.7 mSATA Setup

The mSATA setup jumper specifies whether to automatically detect the mSATA device installed in the PCIe Mini slot (MPCIE1). If the user shorts the mSATA setup jumper to force the system to enable mSATA device, the **S\_ATA6** connector will be disabled.

Setting	Description
Open	Automatically detect mSATA device (default)
Short 1-2	Force to enable mSATA device (The S_ATA6 connector will be disabled)

**Table 4-7: mSATA Setup Jumper Settings**

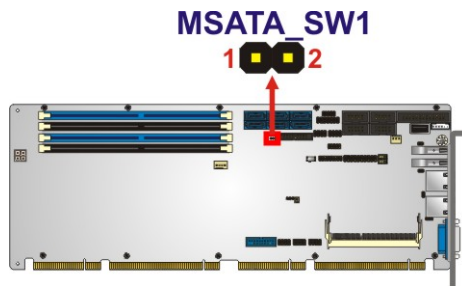

**Figure 4-18: mSATA Setup Jumper Location**

## 4.10 Internal Peripheral Device Connections

This section outlines the installation of peripheral devices to the onboard connectors.

### 4.10.1 SATA Drive Connection

The SPCIE-C236 is shipped with two SATA drive cables. To connect the SATA drives to the connectors, please follow the steps below.

**Step 1: Locate the connectors.** The locations of the SATA drive connectors are shown in **Chapter 3**.

**Step 2: Insert the cable connector.** Insert the cable connector into the on-board SATA drive connector until it clips into place. See **Figure 4-19**.

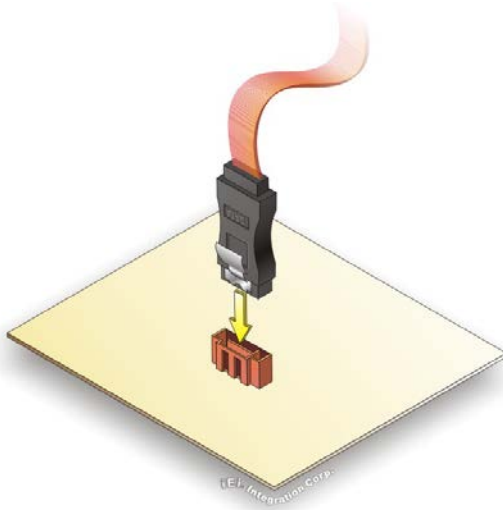

**Figure 4-19: SATA Drive Cable Connection**

**Step 3:** Connect the cable to the **SATA disk**. Connect the connector on the other end of the cable to the connector at the back of the SATA drive. See **Figure 4-20**.

**Step 4:** Connect the **SATA power cable**. Connect the SATA power connector to the back of the SATA drive. See **Figure 4-20**.

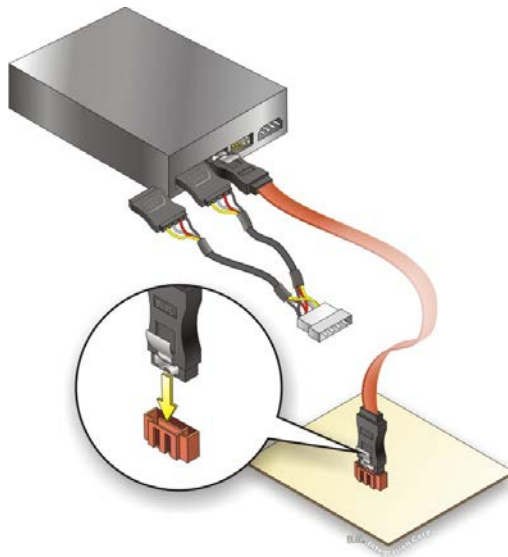

**Figure 4-20: SATA Power Drive Connection**

The SATA power cable can be bought from IEI. See Optional Items in Section 2.4.

## 4.11 Adding USB 3.2 Gen 1 Drivers to a Windows 7 Installation Image

The Windows 7 installation media does not include native driver support for USB 3.2 Gen 1. In order to use the USB keyboard or mouse connected to a USB 3.2 Gen 1 port during OS installation, the user has to update the Windows 7 installation image so that it contains USB 3.0 drivers. Please follow the instructions below to complete the task.

**Step 1:** Prepare a USB flash drive installer.

On a working computer, use your Windows 7 DVD or ISO image to create a bootable USB flash drive.

**Step 2:** Download the Windows 7 USB 3.0 Creator Utility from:

<https://downloadcenter.intel.com/download/25476/Windows-7-USB-3-0-Creator-Utility>.

**Step 3:** Extract the downloaded file to a temporary folder on a computer where the user has logged in as the administrator.



### NOTE:

The OS version of the computer can be Windows 7, Windows 8.1 or Windows 10.

---

**Step 4:** Connect the USB drive containing the Windows 7 installation image to the computer.

**Step 5:** Right click on **Installer\_Creator.exe** from the extracted files and select **Run as administrator**.

**Step 6:** The Windows 7 USB 3.0 Creator Utility screen appears (**Figure 4-21**). Click  to browse to the root of the USB drive containing the Windows 7 image.

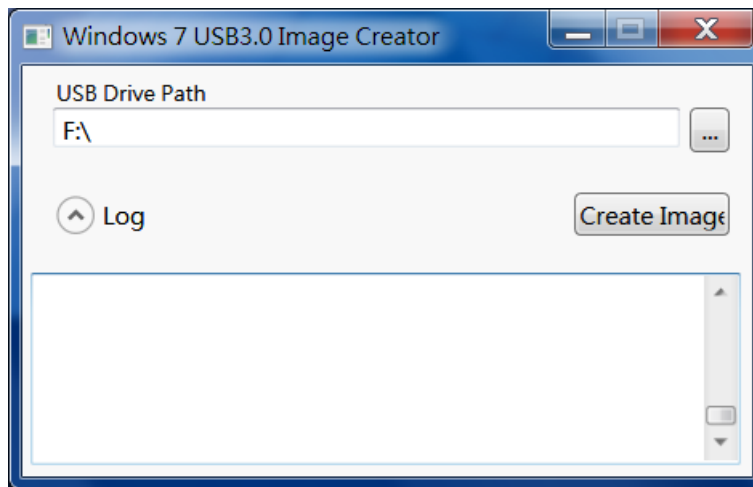

**Figure 4-21: Windows 7 USB 3.0 Creator Utility**

**Step 7:** Click **Create Image** to start the update process.

**Step 8:** Wait for the process to finish. It may take up to 15 minutes.

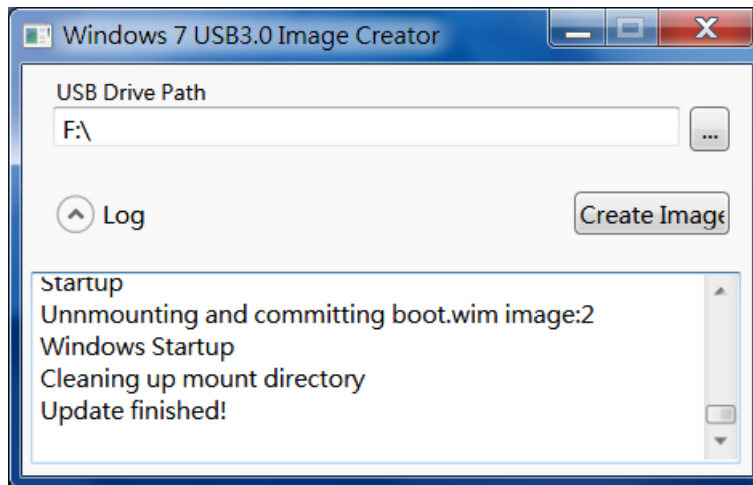

**Figure 4-22: Update Process is Complete**

**Step 9:** Now the user can proceed with the Windows 7 installation using the updated installer.



## SPCIE-C236 Full-size PICMG 1.3 CPU Card

### 4.12 Intel® AMT Setup Procedure

The SPCIE-C236 is featured with the Intel® Active Management Technology (AMT). To enable the Intel® AMT function, follow the steps below.

- Step 1:** Make sure at least one of the memory sockets is installed with a DDR4 DIMM.
- Step 2:** Connect an Ethernet cable to the RJ-45 connector labeled **LAN1**.
- Step 3:** The AMI BIOS options regarding the Intel® ME or Intel® AMT must be enabled,
- Step 4:** Properly install the Intel® Management Engine Components drivers from the iAMT Driver & Utility directory obtained from IEI Resource Download Center.  
See **Chapter 6**.
- Step 5:** Configure the Intel® Management Engine BIOS extension (MEBx). To get into the Intel® MEBx settings, press <Ctrl+P> after a single beep during boot-up process. Enter the Intel® current ME password as it requires (the Intel® default password is **admin**).



#### NOTE:

To change the password, enter a new password following the strong password rule (containing at least one upper case letter, one lower case letter, one digit and one special character, and be at least eight characters).

---

### 4.13 IPMI Setup Procedure (SPCIE-C236-i2 Only)

The SPCIE-C236-i2 features Intelligent Platform Management Interface (IPMI) that helps lower the overall costs of server management by enabling users to maximize IT resources, save time and manage multiple systems. The SPCIE-C236-i2 supports IPMI 2.0 through the optional iRIS-2400 module. Follow the steps below to setup IPMI.

### 4.13.1 Managed System Hardware Setup

The hardware configuration of the managed system (SPCIE-C236-i2) is described below.

- Step 1:** Install an iRIS-2400 module to the IPMI module socket (refer to **Section 4.6**).
- Step 2:** Make sure at least one DDR4 DIMM is installed in one of the DIMM sockets. If multiple DIMMs are installed, all of the DIMMs must be same size, same speed and same brand to get the best performance.
- Step 3:** Connect an Ethernet cable to the RJ-45 connector labeled **LAN2** (**Figure 3-31**).

### 4.13.2 Using the IEI iMAN Web GUI

To manage a client system from a remote console using IEI iMAN Web GUI, follow the steps below.

- Step 1:** Obtain the IP address of the managed system. It is recommended to use the IPMI Tool on the managed system to obtain the IP address. To use IPMI Tool to obtain IP address, follow the steps below:
  - a. Copy the **Ipmitool.exe** file to a bootable USB flash drive.
  - b. Insert the USB flash drive to the SPCIE-C236-i2
  - c. The SPCIE-C236-i2 boots from the USB flash drive
  - d. Enter the following command: **ipmitool 20 30 02 01 03 00 00**  
(there is a space between each two-digit number)
  - e. A serial of number shows. The last four two-digit hexadecimal numbers are the IP address. Convert the hexadecimal numbers to decimal numbers.
- Step 2:** On the remote management console, open a web browser. Enter the managed system IP address in the web browser (**Figure 4-23**).

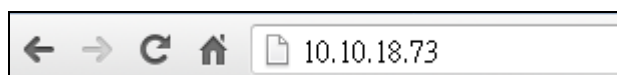

Figure 4-23: IEI iMAN Web Address

## SPCIE-C236 Full-size PICMG 1.3 CPU Card

**Step 3:** The login page appears in the web browser.

**Step 4:** Enter the user name and password to login the system. The default login username and password are:

-Username: **admin**

-Password: **admin**

**Step 5:** Press the login button to login the system.

**Step 6:** The IEI iMAN Web Interface appears.

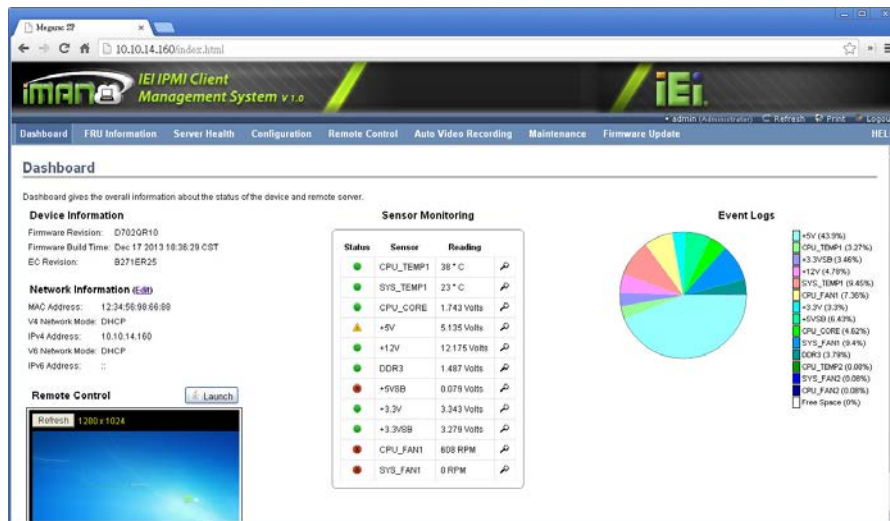

Figure 4-24: IEI iMAN Web GUI



### NOTE:

To understand how to use the IEI iMAN Web GUI, please refer to the iRIS-2400 Web GUI user manual which can be obtained from [IEI Resource Download Center](#). The user manual describes each function in detail.

Chapter

**5**

**BIOS**

---

## SPCIE-C236 Full-size PICMG 1.3 CPU Card

### 5.1 Introduction

The BIOS is programmed onto the BIOS chip. The BIOS setup program allows changes to certain system settings. This chapter outlines the options that can be changed.



#### NOTE:

Some of the BIOS options may vary throughout the life cycle of the product and are subject to change without prior notice.

#### 5.1.1 Starting Setup

The UEFI BIOS is activated when the computer is turned on. The setup program can be activated in one of two ways.

1. Press the **DEL** or **F2** key as soon as the system is turned on or
2. Press the **DEL** or **F2** key when the “**Press DEL or F2 to enter SETUP**” message appears on the screen.

If the message disappears before the **DEL** or **F2** key is pressed, restart the computer and try again.

#### 5.1.2 Using Setup

Use the arrow keys to highlight items, press **ENTER** to select, use the PageUp and PageDown keys to change entries, press **F1** for help and press **ESC** to quit. Navigation keys are shown in the following table.

Key	Function
Up arrow	Move to previous item
Down arrow	Move to next item
Left arrow	Move to the item on the left hand side
Right arrow	Move to the item on the right hand side
+	Increase the numeric value or make changes
-	Decrease the numeric value or make changes
Page Up	Move to the previous page
Page Dn	Move to the next page



Key	Function
Esc	Main Menu – Quit and not save changes into CMOS Status Page Setup Menu and Option Page Setup Menu -- Exit current page and return to Main Menu
F1	General help, only for Status Page Setup Menu and Option Page Setup Menu
F2	Load previous values
F3	Load optimized defaults
F4	Save changes and Exit BIOS

**Table 5-1: BIOS Navigation Keys**

### 5.1.3 Getting Help

When **F1** is pressed, a small help window describing the appropriate keys to use and the possible selections for the highlighted item appears. To exit the Help Window, press **Esc**.

### 5.1.4 Unable to Reboot after Configuration Changes

If the computer cannot boot after changes to the system configuration is made, CMOS defaults. Use the clear CMOS button described in **Chapter 4**.

### 5.1.5 BIOS Menu Bar

The **menu bar** on top of the BIOS screen has the following main items:

- Main – Changes the basic system configuration.
- Advanced – Changes the advanced system settings.
- Chipset – Changes the chipset settings.
- Security – Sets User and Supervisor Passwords.
- Boot – Changes the system boot configuration.
- Save & Exit – Selects exit options and loads default settings
- Server Mgmt – Configures system event log and BMC network parameters

The following sections completely describe the configuration options found in the menu items at the top of the BIOS screen and listed above.

## 5.2 Main

The **Main** BIOS menu (**BIOS Menu 1**) appears when the **BIOS Setup** program is entered. The **Main** menu gives an overview of the basic system information.

## SPCIE-C236 Full-size PICMG 1.3 CPU Card

Aptio Setup Utility - Copyright (C) 2016 American Megatrends, Inc.

Main    Advanced    Chipset    Security    Boot    Save & Exit    Server Mgmt

BIOS Information		Set the Date. Use Tab to switch between Date elements.
BIOS Vendor	American Megatrends	
Core Version	5.11	
Compliance	UEFI 2.4; PI 1.3	
Project Version	B397AR11.ROM	
Build Date and Time	06/17/2016 16:20:22	
BIOS Number	BIOS No.1	
iWDD Vendor	iEi	
iWDD Version	B397ET10.bin	
IPMI Module	N/A	
Processor Information		
Name	SkyLake DT	
Brand String	Intel(R) Xeon(R) CPU E3-1268L v5 @ 2.40GHz	----- →←: Select Screen ↑↓: Select Item Enter: Select +/-: Change Opt. F1: General Help F2: Previous Values F3: Optimized Defaults F4: Save & Exit ESC: Exit
Frequency	2400 MHz	
Processor ID	506E3	
Stepping	R0/S0/N0	
Number of Processors	4Core(s) / 8Thread(s)	
Microcode Revision	7C	
GT Info	GT2	
Memory RC Version	1.8.0.1	
Total Memory	8192 MB	
Memory Frequency	2133 MHz	
PCH Information		
Name	SKL PCH-H	
PCH SKU	Server SKU Intel C236	
Stepping	31/D1	
LAN PHY Revision	B2	
ME FW Version	11.0.0.1194	
ME Firmware SKU	Corporate SKU	
SPI Clock Frequency		
DOFR Support	Unsupported	
Read Status Clock Frequency	17 MHz	
Write Status Clock Frequency	48 MHz	
Fast Read Status Clock Frequency	48 MHz	
Access Level	Administrator	
System Date	[Thu 09/22/2016]	
System Time	[15:10:27]	

Version 2.17.1255. Copyright (C) 2016 American Megatrends, Inc.

**BIOS Menu 1: Main**

The **Main** menu has two user configurable fields:

➔ **System Date [xx/xx/xx]**

Use the **System Date** option to set the system date. Manually enter the day, month and year.

➔ **System Time [xx:xx:xx]**

Use the **System Time** option to set the system time. Manually enter the hours, minutes and seconds.

### 5.3 Advanced

Use the **Advanced** menu (**BIOS Menu 2**) to configure the CPU and peripheral devices through the following sub-menus:



**WARNING!**

Setting the wrong values in the sections below may cause the system to malfunction. Make sure that the settings made are compatible with the hardware.

```

Aptio Setup Utility - Copyright (C) 2016 American Megatrends, Inc.
Main  Advanced  Chipset  Security  Boot  Save & Exit  Server Mgmt
-----
> Trusted Computing
> ACPI Settings
> AMT Configuration
> Super IO Configuration
> iWDD H/M Monitor
> RTC Wake Settings
> Serial Port Console Redirection
> CPU Configuration
> SATA Configuration
> NVMe Configuration
> USB Configuration
> iEi Feature

Trusted Computing
Settings

-----
➔←: Select Screen
↑ ↓: Select Item
Enter: Select
+/-: Change Opt.
F1: General Help
F2: Previous Values
F3: Optimized Defaults
F4: Save & Exit
ESC: Exit

Version 2.17.1255. Copyright (C) 2016 American Megatrends, Inc.
    
```

**BIOS Menu 2: Advanced**

## SPCIE-C236 Full-size PICMG 1.3 CPU Card

### 5.3.1 Trusted Computing

Use the **Trusted Computing** menu (**BIOS Menu 3**) to configure settings related to the Trusted Computing Group (TCG) Trusted Platform Module (TPM).

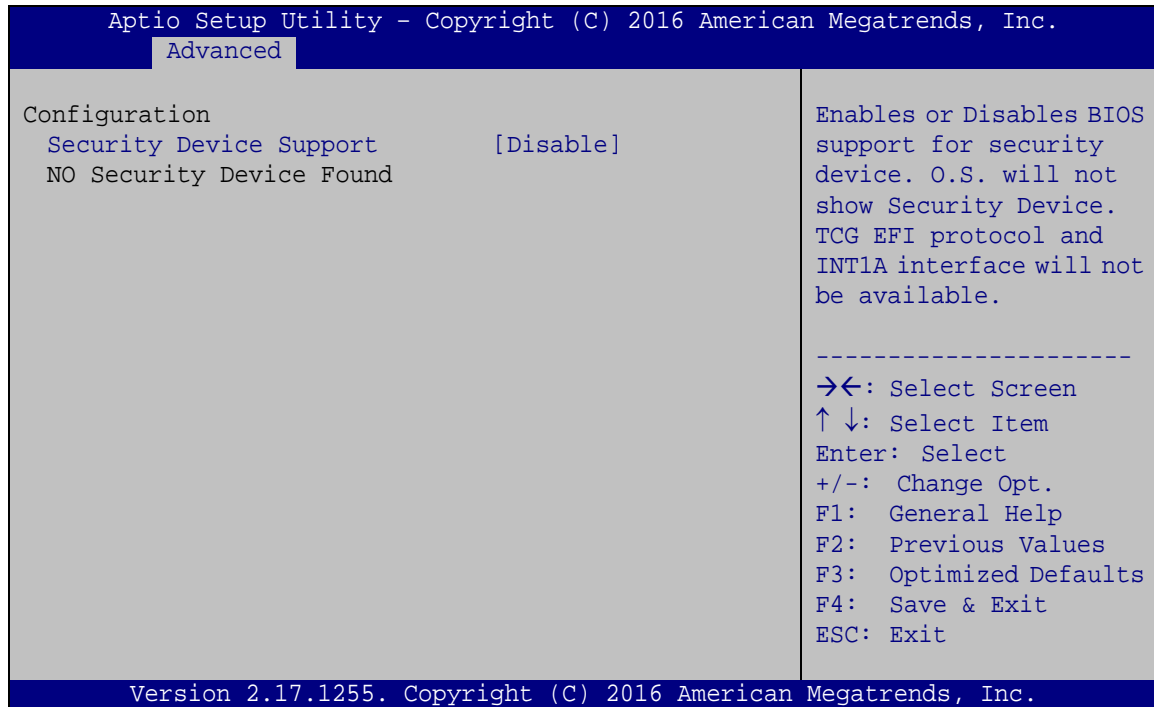

#### BIOS Menu 3: Trusted Computing

##### → Security Device Support [Disable]

Use the **Security Device Support** option to configure support for the TPM.

- **Disable**    DEFAULT    TPM support is disabled.
- **Enable**                    TPM support is enabled.

### 5.3.2 ACPI Settings

The **ACPI Settings** menu (**BIOS Menu 4**) configures the Advanced Configuration and Power Interface (ACPI) options.

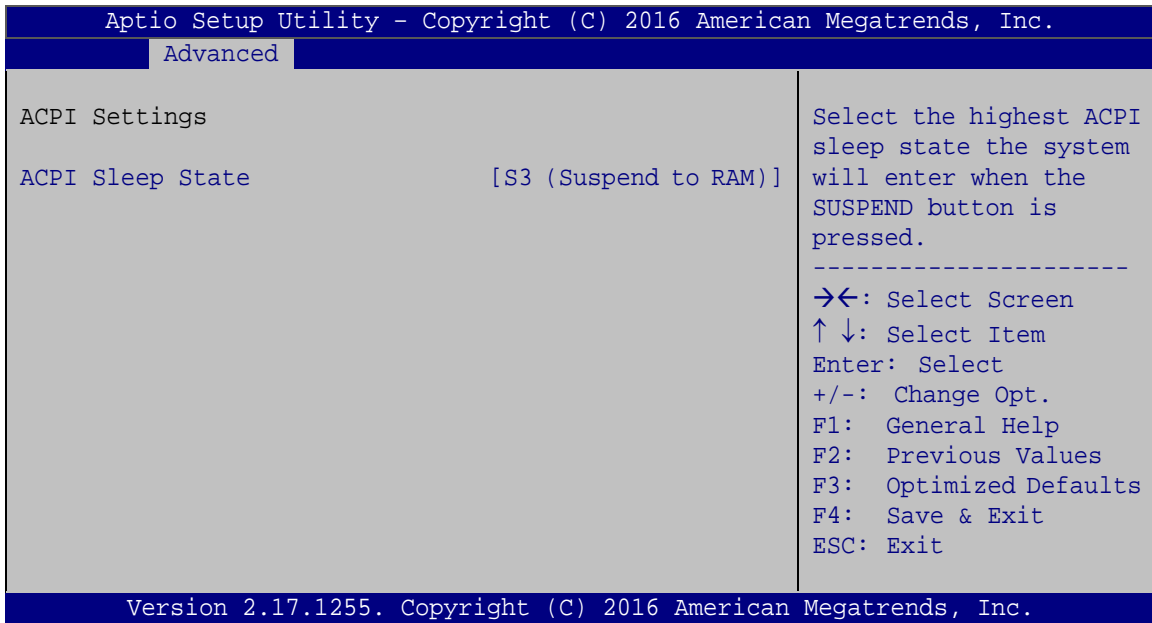

#### BIOS Menu 4: ACPI Configuration

##### → ACPI Sleep State [S3 (Suspend to RAM)]

Use the **ACPI Sleep State** option to specify the sleep state the system enters when it is not being used.

- **S3 (Suspend to RAM)**      **DEFAULT**      The caches are flushed and the CPU is powered off. Power to the RAM is maintained. The computer returns slower to a working state, but more power is saved.



## SPCIE-C236 Full-size PICMG 1.3 CPU Card

### 5.3.3 AMT Configuration

The **AMT Configuration** menu (**BIOS Menu 5**) allows the Intel® AMT options to be configured.

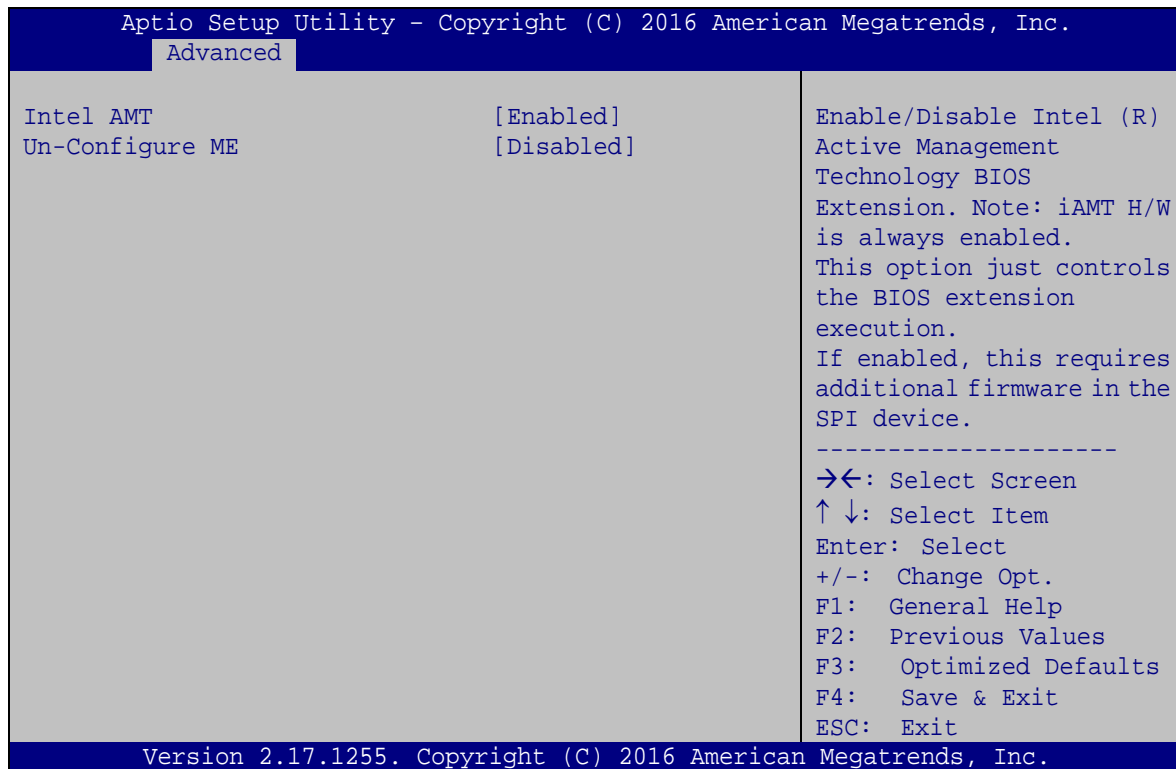

#### BIOS Menu 5: AMT Configuration

##### → Intel AMT [Enabled]

Use **Intel AMT** option to enable or disable the Intel® AMT function.

- **Disabled** Intel® AMT is disabled
- **Enabled** **DEFAULT** Intel® AMT is enabled

##### → Un-Configure ME [Disabled]

Use the **Un-Configure ME** option to perform ME unconfigure without password operation.

- **Disabled** **DEFAULT** Not perform ME unconfigure
- **Enabled** To perform ME unconfigure

### 5.3.4 Super IO Configuration

Use the **Super IO Configuration** menu (**BIOS Menu 6**) to set or change the configurations for the serial ports and parallel port.

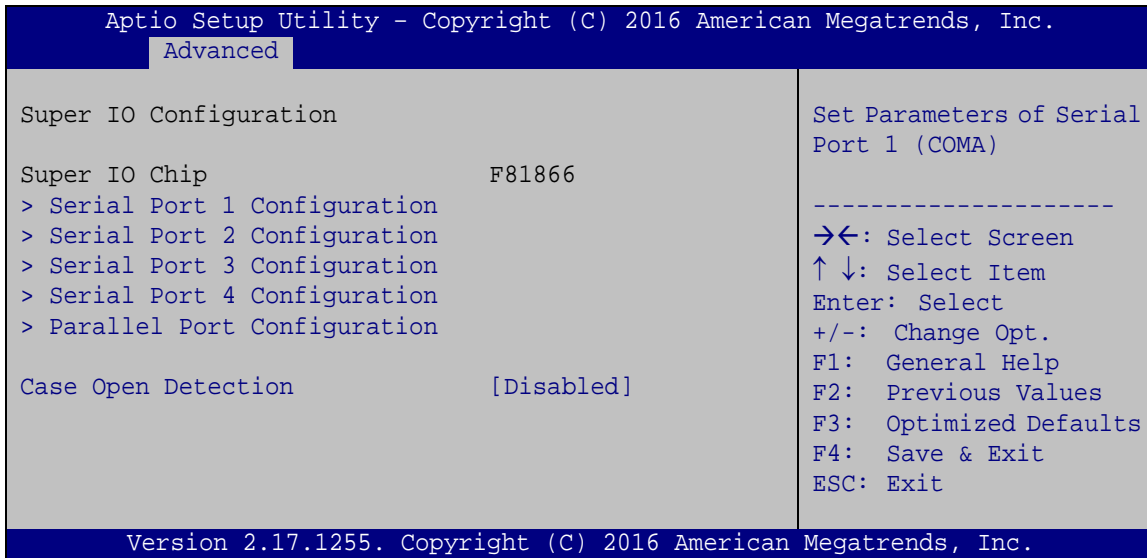

#### BIOS Menu 6: Super IO Configuration

##### → Case Open Detection [Disabled]

Use the **Case Open Detection** option to enable or disable the case open detection function.

- **Disabled**      **DEFAULT**      Disable the case open detection function
- **Enabled**                      Enable the case open detection function

## SPCIE-C236 Full-size PICMG 1.3 CPU Card

### 5.3.4.1 Serial Port n Configuration

Use the **Serial Port n Configuration** menu (**BIOS Menu 7**) to configure the serial port n.

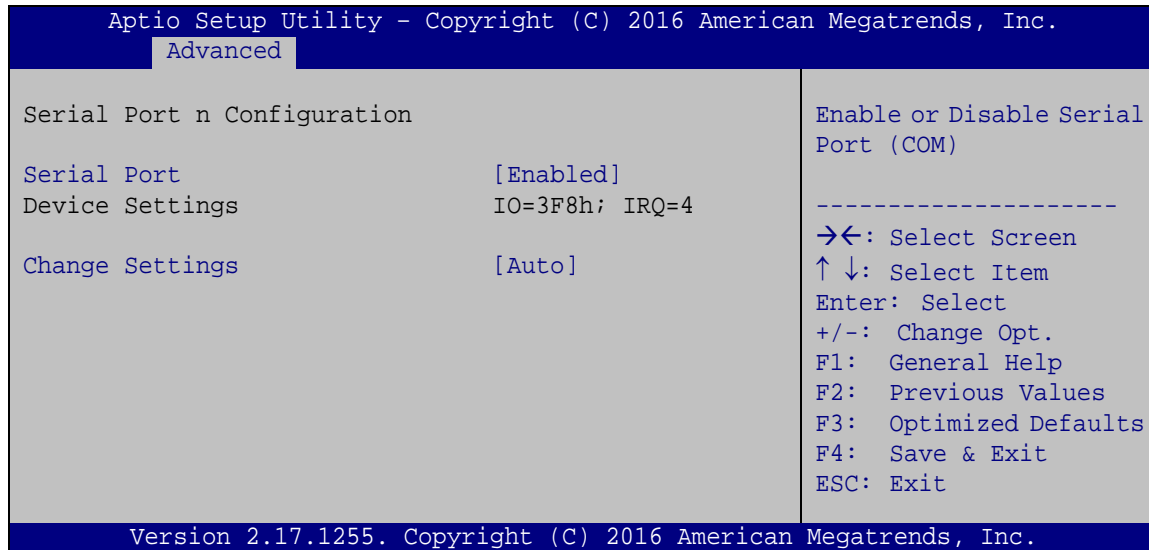

#### BIOS Menu 7: Serial Port n Configuration Menu

#### 5.3.4.1.1 Serial Port 1 Configuration

##### → Serial Port [Enabled]

Use the **Serial Port** option to enable or disable the serial port.

- **Disabled** Disable the serial port
- **Enabled** **DEFAULT** Enable the serial port

##### → Change Settings [Auto]

Use the **Change Settings** option to change the serial port IO port address and interrupt address.

- **Auto** **DEFAULT** The serial port IO port address and interrupt address are automatically detected.
- **IO=3F8h; IRQ=4** Serial Port I/O port address is 3F8h and the interrupt address is IRQ4

- |                            |   |
|----------------------------|---|
| → IO=3F8h;<br>IRQ=3, 4, 11 | Serial Port I/O port address is 3F8h and the interrupt address is IRQ3, 4, 11 |
| → IO=2F8h;<br>IRQ=3, 4, 11 | Serial Port I/O port address is 2F8h and the interrupt address is IRQ3, 4, 11 |
| → IO=3E8h;<br>IRQ=3, 4, 11 | Serial Port I/O port address is 3E8h and the interrupt address is IRQ3, 4, 11 |
| → IO=2E8h;<br>IRQ=3, 4, 11 | Serial Port I/O port address is 2E8h and the interrupt address is IRQ3, 4, 11 |
| → IO=2D0h;<br>IRQ=3, 4, 11 | Serial Port I/O port address is 2D0h and the interrupt address is IRQ3, 4, 11 |
| → IO=2E0h;<br>IRQ=3, 4, 11 | Serial Port I/O port address is 2E0h and the interrupt address is IRQ3, 4, 11 |

### 5.3.4.1.2 Serial Port 2 Configuration

#### → Serial Port [Enabled]

Use the **Serial Port** option to enable or disable the serial port.

- |                          |                         |
|--------------------------|-------------------------|
| → Disabled               | Disable the serial port |
| → Enabled <b>DEFAULT</b> | Enable the serial port  |

#### → Change Settings [Auto]

Use the **Change Settings** option to change the serial port IO port address and interrupt address.

- |                            |   |
|----------------------------|---|
| → Auto <b>DEFAULT</b>      | The serial port IO port address and interrupt address are automatically detected. |
| → IO=2F8h;<br>IRQ=3        | Serial Port I/O port address is 2F8h and the interrupt address is IRQ3            |
| → IO=3F8h;<br>IRQ=3, 4, 11 | Serial Port I/O port address is 3F8h and the interrupt address is IRQ3, 4, 11     |

## SPCIE-C236 Full-size PICMG 1.3 CPU Card

- **IO=2F8h;**  
**IRQ=3, 4, 11**      Serial Port I/O port address is 2F8h and the interrupt address is IRQ3, 4, 11
- **IO=3E8h;**  
**IRQ=3, 4, 11**      Serial Port I/O port address is 3E8h and the interrupt address is IRQ3, 4, 11
- **IO=2E8h;**  
**IRQ=3, 4, 11**      Serial Port I/O port address is 2E8h and the interrupt address is IRQ3, 4, 11
- **IO=2D0h;**  
**IRQ=3, 4, 11**      Serial Port I/O port address is 2D0h and the interrupt address is IRQ3, 4, 11
- **IO=2E0h;**  
**IRQ=3, 4, 11**      Serial Port I/O port address is 2E0h and the interrupt address is IRQ3, 4, 11

### 5.3.4.1.3 Serial Port 3 Configuration

#### → Serial Port [Enabled]

Use the **Serial Port** option to enable or disable the serial port.

- **Disabled**      Disable the serial port
- **Enabled**      **DEFAULT**      Enable the serial port

#### → Change Settings [Auto]

Use the **Change Settings** option to change the serial port IO port address and interrupt address.

- **Auto**      **DEFAULT**      The serial port IO port address and interrupt address are automatically detected.
- **IO=3E8h;**  
**IRQ=11**      Serial Port I/O port address is 3E8h and the interrupt address is IRQ11
- **IO=3F8h;**  
**IRQ=3, 4, 11**      Serial Port I/O port address is 3F8h and the interrupt address is IRQ3, 4, 11
- **IO=2F8h;**  
**IRQ=3, 4, 11**      Serial Port I/O port address is 2F8h and the interrupt address is IRQ3, 4, 11



- **IO=3E8h;**  
**IRQ=3, 4, 11**      Serial Port I/O port address is 3E8h and the interrupt address is IRQ3, 4, 11
- **IO=2E8h;**  
**IRQ=3, 4, 11**      Serial Port I/O port address is 2E8h and the interrupt address is IRQ3, 4, 11
- **IO=2D0h;**  
**IRQ=3, 4, 11**      Serial Port I/O port address is 2D0h and the interrupt address is IRQ3, 4, 11
- **IO=2E0h;**  
**IRQ=3, 4, 11**      Serial Port I/O port address is 2E0h and the interrupt address is IRQ3, 4, 11

### → Transfer Mode [RS232]

The serial port allows setting the data transfer mode to RS-232, RS-422 or RS-485.

#### 5.3.4.1.4 Serial Port 4 Configuration

### → Serial Port [Enabled]

Use the **Serial Port** option to enable or disable the serial port.

- **Disabled**      Disable the serial port
- **Enabled**      **DEFAULT**      Enable the serial port

### → Change Settings [Auto]

Use the **Change Settings** option to change the serial port IO port address and interrupt address.

- **Auto**      **DEFAULT**      The serial port IO port address and interrupt address are automatically detected.
- **IO=2E8h;**  
**IRQ=11**      Serial Port I/O port address is 2E8h and the interrupt address is IRQ11
- **IO=3F8h;**  
**IRQ=3, 4, 11**      Serial Port I/O port address is 3F8h and the interrupt address is IRQ3, 4, 11

## SPCIE-C236 Full-size PICMG 1.3 CPU Card

- ➔ **IO=2F8h;**  
**IRQ=3, 4, 11**                      Serial Port I/O port address is 2F8h and the interrupt address is IRQ3, 4, 11
- ➔ **IO=3E8h;**  
**IRQ=3, 4, 11**                      Serial Port I/O port address is 3E8h and the interrupt address is IRQ3, 4, 11
- ➔ **IO=2E8h;**  
**IRQ=3, 4, 11**                      Serial Port I/O port address is 2E8h and the interrupt address is IRQ3, 4, 11
- ➔ **IO=2D0h;**  
**IRQ=3, 4, 11**                      Serial Port I/O port address is 2D0h and the interrupt address is IRQ3, 4, 11
- ➔ **IO=2E0h;**  
**IRQ=3, 4, 11**                      Serial Port I/O port address is 2E0h and the interrupt address is IRQ3, 4, 11

### ➔ Transfer Mode [RS232]

The serial port allows setting the data transfer mode to RS-232, RS-422 or RS-485.

### 5.3.4.2 Parallel Port Configuration

Use the **Parallel Port Configuration** menu (**BIOS Menu 8**) to configure the parallel port.

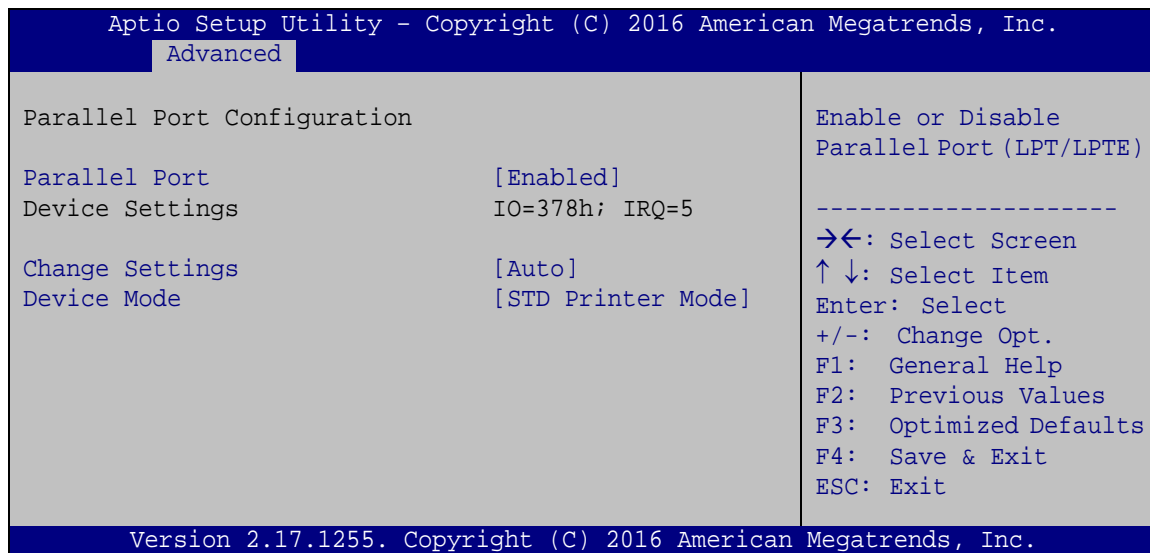

**BIOS Menu 8: Parallel Port Configuration Menu**

→ **Parallel Port [Enabled]**

Use the **Parallel Port** option to enable or disable the parallel port.

- **Disabled**                      Disable the parallel port
- **Enabled**      **DEFAULT**      Enable the parallel port

→ **Device Mode [STD Printer Mode]**

Use the **Device Mode** option to select the mode the parallel port operates in. Configuration options are listed below.

- STD Printer Mode                      **Default**
- SPP Mode
- EPP-1.9 and SPP Mode
- EPP-1.7 and SPP Mode
- ECP Mode
- ECP and EPP 1.9 Mode
- ECP and EPP 1.7 Mode

### 5.3.5 iWDD H/W Monitor

The **iWDD H/W Monitor** menu (**BIOS Menu 9**) contains the fan configuration submenu, and displays operating temperature, fan speeds and system voltages.

## SPCIE-C236 Full-size PICMG 1.3 CPU Card

```

Aptio Setup Utility - Copyright (C) 2016 American Megatrends, Inc.
Advanced
PC Health Status
CPU temperature           : +40°C
SYS temperature          : +36°C

CPU_FAN1 Speed           : 1416 RPM
SYS_FAN1 Speed           : N/A

CPU_CORE                  : +0.979 V
+5V                       : +5.099 V
+12V                      : +12.129 V
+DDR                      : +1.202 V
+5VSB                     : +5.070 V
+3.3V                     : +3.343 V
+3.3VSB                   : +3.317 V

> Smart Fan Mode Configuration

Smart Fan Mode Select

-----
-><: Select Screen
↑↓: Select Item
Enter: Select
+/-: Change Opt.
F1: General Help
F2: Previous Values
F3: Optimized Defaults
F4: Save & Exit
ESC: Exit

Version 2.17.1255. Copyright (C) 2016 American Megatrends, Inc.

```

### BIOS Menu 9: iWDD H/W Monitor

#### → PC Health Status

The following system parameters and values are shown. The system parameters that are monitored are:

- System Temperatures:
  - CPU Temperature
  - System Temperature
- Fan Speed:
  - CPU Fan Speed
  - System Fan Speed
- Voltages:
  - CPU\_CORE
  - +5V
  - +12V
  - +DDR
  - +5VSB
  - +3.3V
  - +3.3VSB

### 5.3.5.1 Smart Fan Mode Configuration

Use the **Smart Fan Mode Configuration** submenu (**BIOS Menu 10**) to configure fan speed settings.

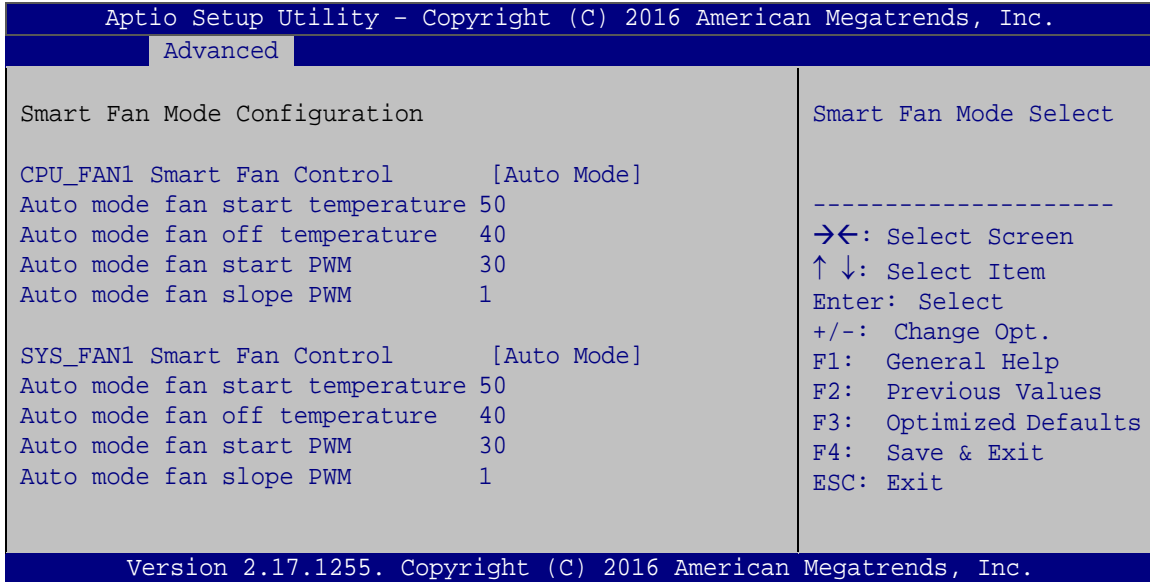

#### BIOS Menu 10: Smart Fan Mode Configuration

##### → CPU\_FAN1 Smart Fan Control/SYS\_FAN1 Smart Fan Control [Auto Mode]

Use the **CPU\_FAN1 Smart Fan Control/SYS\_FAN1 Smart Fan Control** option to configure the CPU/system fan.

→ **Auto Mode**      **DEFAULT**      The fan adjusts its speed using Auto Mode settings.

→ **Manual Mode**                      The fan spins at the speed set in Manual Mode settings.

##### → Auto mode fan start/off temperature

Use the + or – key to change the **Auto mode fan start/off temperature** value. Enter a decimal number between 1 and 100.

##### → Auto mode fan start PWM

Use the + or – key to change the **Auto mode fan start PWM** value. Enter a decimal number between 1 and 100.



## SPCIE-C236 Full-size PICMG 1.3 CPU Card

### → Auto mode fan slope PWM

Use the + or – key to change the **Auto mode fan slope PWM** value. Enter a decimal number between 1 and 8.

### 5.3.6 RTC Wake Settings

The **RTC Wake Settings** menu (**BIOS Menu 11**) enables the system to wake at the specified time.

```

Aptio Setup Utility - Copyright (C) 2016 American Megatrends, Inc.
  Advanced
Wake system with Fixed Time      [Disabled]
Enable or disable System
wake on alarm event. When
enabled, System will
wake on the
date::hr::min::sec
specified
-----
→←: Select Screen
↑↓: Select Item
Enter: Select
+/-: Change Opt.
F1: General Help
F2: Previous Values
F3: Optimized Defaults
F4: Save & Exit
ESC: Exit
Version 2.17.1255. Copyright (C) 2016 American Megatrends, Inc.

```

#### BIOS Menu 11: RTC Wake Settings

### → Wake system with Fixed Time [Disabled]

Use the **Wake system with Fixed Time** option to enable or disable the system wake on alarm event.

- **Disabled**      **DEFAULT**      The real time clock (RTC) cannot generate a wake event.
- **Enabled**                      If selected, the **Wake up every day** option appears allowing you to enable to disable the system to wake every day at the specified time. Besides, the following options appear with values that can be

selected:

Wake up date

Wake up hour

Wake up minute

Wake up second

After setting the alarm, the computer turns itself on from a suspend state when the alarm goes off.

### 5.3.7 Serial Port Console Redirection

The **Serial Port Console Redirection** menu (**BIOS Menu 12**) allows the console redirection options to be configured. Console redirection allows users to maintain a system remotely by re-directing keyboard input and text output through the serial port.

```

Aptio Setup Utility - Copyright (C) 2016 American Megatrends, Inc.
  Advanced
COM1
  Console Redirection          [Disabled]      Console Redirection
  > Console Redirection Settings      Enable or Disable

COM2
  Console Redirection          [Disabled]
  > Console Redirection Settings
-----
-><: Select Screen
↑↓: Select Item
Enter: Select
+/-: Change Opt.
F1: General Help
F2: Previous Values
F3: Optimized Defaults
F4: Save & Exit
ESC: Exit

COM3
  Console Redirection          [Disabled]
  > Console Redirection Settings

COM4
  Console Redirection          [Disabled]
  > Console Redirection Settings

COM5 (BMC)
  Console Redirection          Port Is Disabled

iAMT SOL

COM6 (Pci Bus0,Dev0,Func0) (Disabled)
  Console Redirection          Port Is Disabled

Legacy Console Redirection
  > Legacy Console Redirection Settings

Version 2.17.1255. Copyright (C) 2016 American Megatrends, Inc.
  
```

**BIOS Menu 12: Serial Port Console Redirection**

## SPCIE-C236 Full-size PICMG 1.3 CPU Card

### → Console Redirection [Disabled]

Use **Console Redirection** option to enable or disable the console redirection function.

- **Disabled**      **DEFAULT**      Disabled the console redirection function
- **Enabled**                      Enabled the console redirection function

The following options are available in the **Console Redirection Settings** submenu when the **Console Redirection** option is enabled.

### → Terminal Type [ANSI]

Use the **Terminal Type** option to specify the remote terminal type.

- **VT100**                      The target terminal type is VT100
- **VT100+**                      The target terminal type is VT100+
- **VT-UTF8**                      The target terminal type is VT-UTF8
- **ANSI**              **DEFAULT**      The target terminal type is ANSI

### → Bits per second [115200]

Use the **Bits per second** option to specify the serial port transmission speed. The speed must match the other side. Long or noisy lines may require lower speeds.

- **9600**                      Sets the serial port transmission speed at 9600.
- **19200**                      Sets the serial port transmission speed at 19200.
- **57600**                      Sets the serial port transmission speed at 57600.
- **115200**              **DEFAULT**      Sets the serial port transmission speed at 115200.

### → Data Bits [8]

Use the **Data Bits** option to specify the number of data bits.

- **7**                      Sets the data bits at 7.
- **8**                      **DEFAULT**      Sets the data bits at 8.

**→ Parity [None]**

Use the **Parity** option to specify the parity bit that can be sent with the data bits for detecting the transmission errors.

- |                |                |   |
|----------------|----------------|---|
| <b>→ None</b>  | <b>DEFAULT</b> | No parity bit is sent with the data bits.                                 |
| <b>→ Even</b>  |                | The parity bit is 0 if the number of ones in the data bits is even.       |
| <b>→ Odd</b>   |                | The parity bit is 0 if the number of ones in the data bits is odd.        |
| <b>→ Mark</b>  |                | The parity bit is always 1. This option does not provide error detection. |
| <b>→ Space</b> |                | The parity bit is always 0. This option does not provide error detection. |

**→ Stop Bits [1]**

Use the **Stop Bits** option to specify the number of stop bits used to indicate the end of a serial data packet. Communication with slow devices may require more than 1 stop bit.

- |            |                |                                    |
|------------|----------------|------------------------------------|
| <b>→ 1</b> | <b>DEFAULT</b> | Sets the number of stop bits at 1. |
| <b>→ 2</b> |                | Sets the number of stop bits at 2. |

## SPCIE-C236 Full-size PICMG 1.3 CPU Card

## 5.3.7.1 Legacy Console Redirection Settings

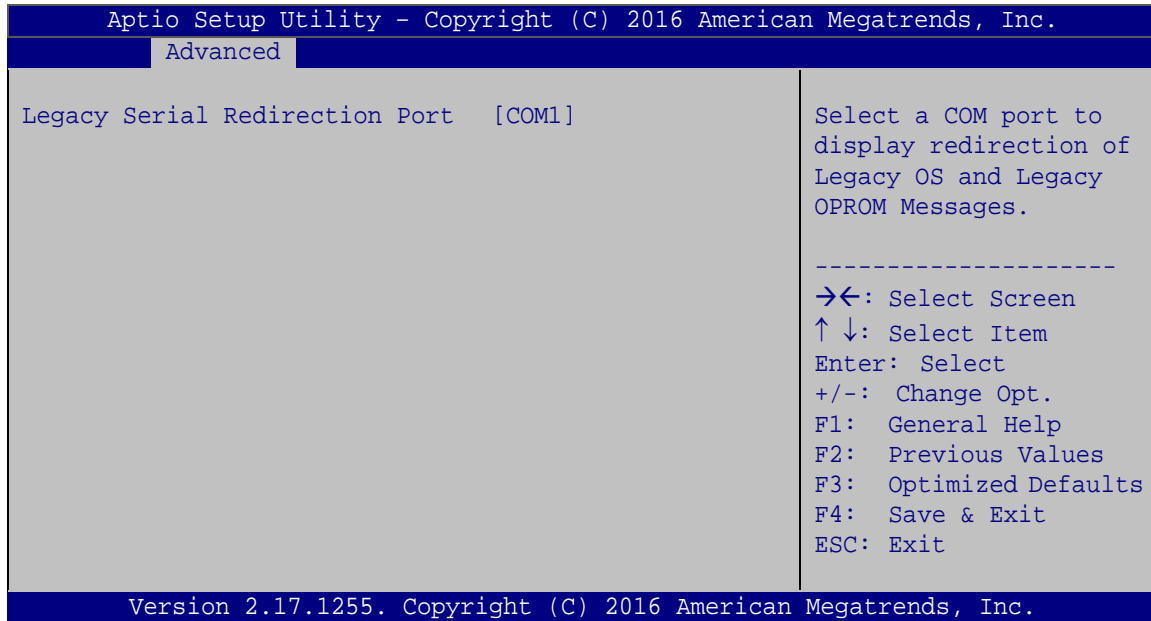

## BIOS Menu 13: Legacy Console Redirection Settings

## → Legacy Serial Redirection Port [COM1]

Use the **Legacy Serial Redirection Port** option to select a COM port to display redirection of legacy OS and legacy OPRM messages. Configuration options are listed below.

- COM1 **Default**
- COM2
- COM3
- COM4
- COM5 (Disabled)
- COM6 (Pci Bus0,Dev0,Func0) (Disabled)



### 5.3.8 CPU Configuration

Use the **CPU Configuration** menu (**BIOS Menu 14**) to view detailed CPU specifications or enable the Intel Virtualization Technology.

```

Aptio Setup Utility - Copyright (C) 2016 American Megatrends, Inc.
  Advanced
CPU Configuration
Intel(R) Xeon(R) E3-1268L v5 CPU @ 2.40GHz
CPU Signature          506E3
Microcode Patch       7C
Max CPU Speed         2400 MHz
Min CPU Speed         800 MHz
CPU Speed             2400 MHz
Processor Cores       4
Hyper Threading Technology Not Supported
Intel VT-x Technology Supported
Intel SMX Technology  Supported
64-bit                Supported
EIST Technology       Supported

L1 Data Cache        32 kB x 4
L1 Code Cache        32 kB x 4
L2 Cache             256 kB x 4
L3 Cache             8 MB

Hyper-threading      [Enabled]
Active Processor Cores [All]
Intel Virtualization Technology [Disabled]
Intel(R) SpeedStep(tm) [Enabled]
CPU C states         [Disabled]
Intel TXT(LT) Support [Disabled]

-----
-><: Select Screen
↑↓: Select Item
Enter: Select
+/-: Change Opt.
F1: General Help
F2: Previous Values
F3: Optimized Defaults
F4: Save & Exit
ESC: Exit

Version 2.17.1255. Copyright (C) 2016 American Megatrends, Inc.
  
```

#### BIOS Menu 14: CPU Configuration

##### → Hyper-threading [Enabled]

Use the **Hyper-threading** BIOS option to enable or disable the Intel Hyper-Threading Technology.

- **Disabled**                      Disables the Intel Hyper-Threading Technology.
- **Enabled**    **DEFAULT**        Enables the Intel Hyper-Threading Technology.

## SPCIE-C236 Full-size PICMG 1.3 CPU Card

### → Active Processor Cores [All]

Use the **Active Processor Cores** BIOS option to enable numbers of cores in the processor package.

- **All**            **DEFAULT**    Enable all cores in the processor package.
- **1**                            Enable one core in the processor package.

### → Intel Virtualization Technology [Disabled]

Use the **Intel Virtualization Technology** option to enable or disable virtualization on the system. When combined with third party software, Intel® Virtualization technology allows several OSs to run on the same system at the same time.

- **Disabled**                    **DEFAULT**    Disables Intel Virtualization Technology.
- **Enabled**                            Enables Intel Virtualization Technology.

### → Intel(R) SpeedStep(tm) [Enabled]

Use the **Intel(R) SpeedStep(tm)** option to enable or disable the Intel® SpeedStep Technology which allows more than two frequency ranges to be supported.

- **Disabled**                            Disables Intel® SpeedStep Technology
- **Enabled**                    **DEFAULT**    Enables Intel® SpeedStep Technology

### → CPU C states [Disabled]

Use the **CPU C states** option to enable or disable the CPU C states.

- **Disabled**                    **DEFAULT**    Disables the CPU C states.
- **Enabled**                            Enables the CPU C states.

➔ **Intel TXT(LT) Support [Disabled]**

Use the **Intel TXT(LT) Support** option to enable or disable the Intel(R) TXT(LT) support.

- ➔ **Disabled**                      **DEFAULT**      Disables Intel® TXT(LT) support
- ➔ **Enabled**                                      Enables Intel® TXT(LT) support

**5.3.9 SATA Configuration**

Use the **SATA Configuration** menu (**BIOS Menu 15**) to change and/or set the configuration of the SATA devices installed in the system.

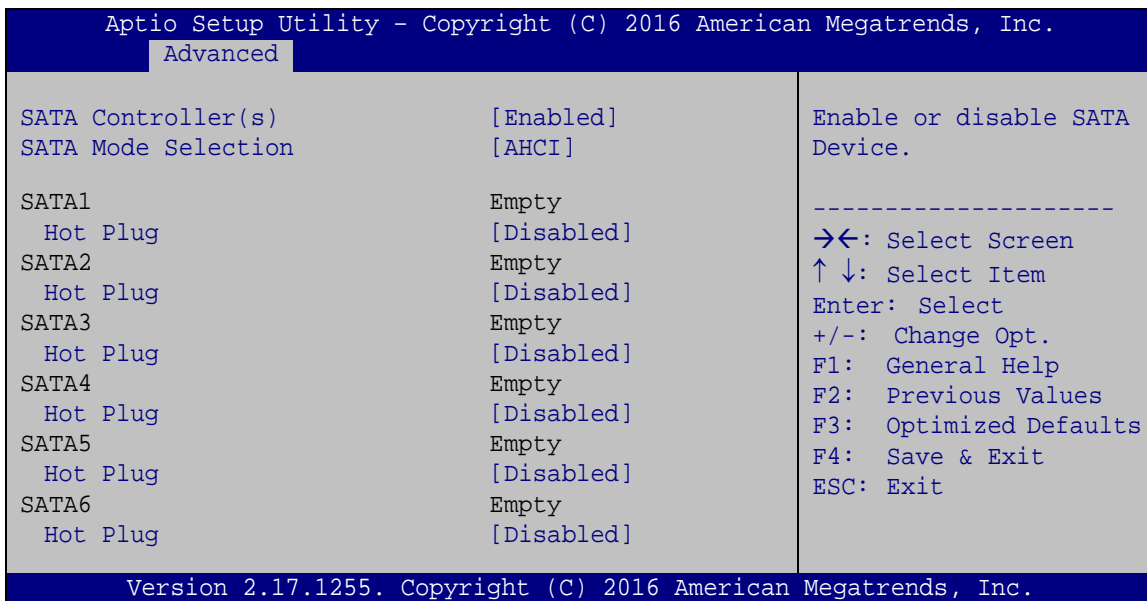

**BIOS Menu 15: SATA Configuration**

➔ **SATA Controller(s) [Enabled]**

Use the **SATA Controller(s)** option to configure the SATA controller(s).

- ➔ **Enabled**                      **DEFAULT**      Enables the on-board SATA controller(s).
- ➔ **Disabled**                                      Disables the on-board SATA controller(s).

➔ **SATA Mode Selection [AHCI]**

Use the **SATA Mode Selection** option to determine how the SATA devices operate.

- ➔ **AHCI**                      **DEFAULT**      Configures SATA devices as AHCI device.
- ➔ **RAID**                                      Configures SATA devices as RAID device.

## SPCIE-C236 Full-size PICMG 1.3 CPU Card

### → Hot Plug [Disabled]

Use the **Hot Plug** option to designate the correspondent SATA port as hot-pluggable.

- **Disabled**      **DEFAULT**      Disables the hot-pluggable function of the SATA port.
- **Enabled**                      Designates the SATA port as hot-pluggable.

### 5.3.10 NVMe Configuration

Use the **NVMe Configuration (BIOS Menu 16)** menu to display the NVMe controller and device information.

```

Aptio Setup Utility - Copyright (C) 2016 American Megatrends, Inc.
  Advanced
-----
NVMe controller and Drive information
No NVME Device Found

-----
-><: Select Screen
↑↓: Select Item
Enter: Select
+/-: Change Opt.
F1: General Help
F2: Previous Values
F3: Optimized Defaults
F4: Save & Exit
ESC: Exit

Version 2.17.1255. Copyright (C) 2016 American Megatrends, Inc.

```

#### BIOS Menu 16: NVMe Configuration

### 5.3.11 USB Configuration

Use the **USB Configuration** menu (**BIOS Menu 17**) to read USB configuration information and configure the USB settings.

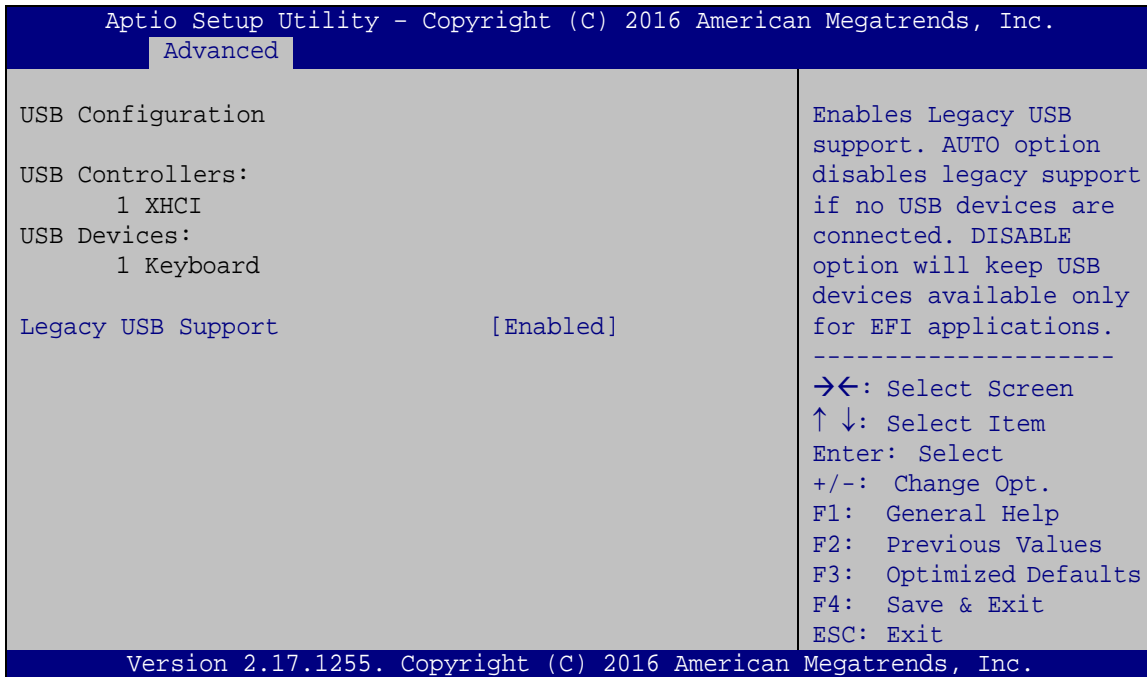

#### BIOS Menu 17: USB Configuration

##### ➔ Legacy USB Support [Enabled]

Use the **Legacy USB Support** BIOS option to enable USB mouse and USB keyboard support. Normally if this option is not enabled, any attached USB mouse or USB keyboard does not become available until a USB compatible operating system is fully booted with all USB drivers loaded. When this option is enabled, any attached USB mouse or USB keyboard can control the system even when there is no USB driver loaded onto the system.

- ➔ **Enabled**      **DEFAULT**      Legacy USB support enabled
- ➔ **Disabled**                      Legacy USB support disabled
- ➔ **Auto**                              Legacy USB support disabled if no USB devices are connected



## SPCIE-C236 Full-size PICMG 1.3 CPU Card

### 5.3.12 iEi Feature

Use the **iEi Feature** menu (**BIOS Menu 18**) to configure One Key Recovery function.

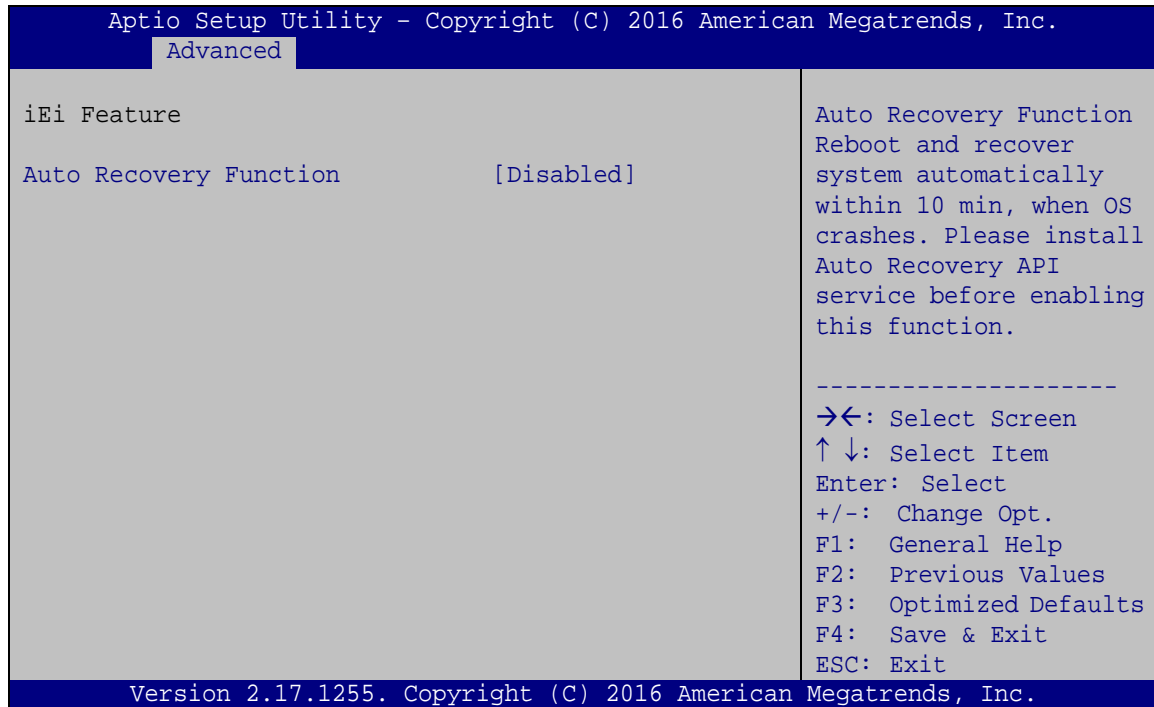

#### BIOS Menu 18: iEi Feature

##### ➔ Auto Recovery Function [Disabled]

Use the **Auto Recovery Function** BIOS option to enable or disable the auto recovery function of the IEI One Key Recovery.

- ➔ **Disabled**     **DEFAULT**     Auto recovery function disabled
- ➔ **Enabled**     Auto recovery function enabled

## 5.4 Chipset

Use the **Chipset** menu (**BIOS Menu 19**) to access the PCH IO and System Agent (SA) configuration menus.



### WARNING!

Setting the wrong values for the Chipset BIOS selections in the Chipset BIOS menu may cause the system to malfunction.

```

Aptio Setup Utility - Copyright (C) 2016 American Megatrends, Inc.
Main   Advanced  Chipset  Security  Boot   Save & Exit  Server Mgmt
-----
> System Agent (SA) Configuration      System Agent (SA)
> PCH-IO Configuration                Parameters
-----
-><: Select Screen
↑↓: Select Item
Enter: Select
+/-: Change Opt.
F1: General Help
F2: Previous Values
F3: Optimized Defaults
F4: Save & Exit
ESC: Exit

Version 2.17.1255. Copyright (C) 2016 American Megatrends, Inc.
    
```

**BIOS Menu 19: Chipset**

## SPCIE-C236 Full-size PICMG 1.3 CPU Card

### 5.4.1 System Agent (SA) Configuration

Use the **System Agent (SA) Configuration** menu (**BIOS Menu 20**) to configure the System Agent (SA) parameters.

```

Aptio Setup Utility - Copyright (C) 2016 American Megatrends, Inc.
Chipset
-----
VT-d                Supported
VT-d                [Disabled]
VT-d capability
-----
> Graphics Configuration
> PEG Port Configuration
> Memory Configuration
-----
-><: Select Screen
↑ ↓: Select Item
Enter: Select
+/-: Change Opt.
F1: General Help
F2: Previous Values
F3: Optimized Defaults
F4: Save & Exit
ESC: Exit
-----
Version 2.17.1255. Copyright (C) 2016 American Megatrends, Inc.
    
```

#### BIOS Menu 20: System Agent (SA) Configuration

##### → VT-d [Disabled]

Use the **VT-d** option to enable or disable VT-d capability.

- **Disabled**                      **DEFAULT**      Disables VT-d capability.
- **Enabled**                                      Enables VT-d capability.

### 5.4.1.1 Graphics Configuration

Use the **Graphics Configuration (BIOS Menu 21)** menu to configure the video device connected to the system.

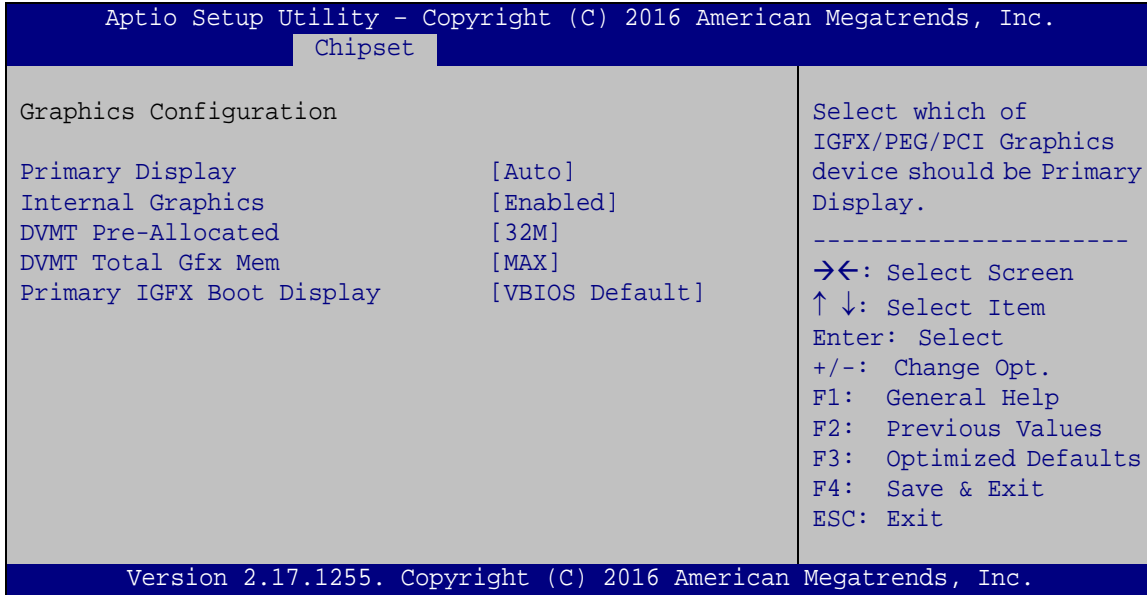

#### BIOS Menu 21: Graphics Configuration

##### → Primary Display [Auto]

Use the **Primary Display** option to select the primary graphics controller the system uses.

The following options are available:

- Auto **Default**
- IGFX
- PEG
- PCIE

##### → Internal Graphics [Enabled]

Use the **Internal Graphics** option to keep IGFX enabled basing on the setup options. The following options are available:

- Auto
- Disabled
- Enabled **Default**

## SPCIE-C236 Full-size PICMG 1.3 CPU Card

### → DVMT Pre-Allocated [32M]

Use the **DVMT Pre-Allocated** option to set the amount of system memory allocated to the integrated graphics processor when the system boots. The system memory allocated can then only be used as graphics memory, and is no longer available to applications or the operating system. Configuration options are listed below:

- 32M                      **Default**
- 64M

### → DVMT Total Gfx Mem [MAX]

Use the **DVMT Total Gfx Mem** option to select DVMT5.0 total graphic memory size used by the internal graphic device. The following options are available:

- 128M
- 256M
- MAX                      **Default**

### → Primary IGFX Boot Display [VBIOS Default]

Use the **Primary IGFX Boot Display** option to select the display device used by the system when it boots. Configuration options are listed below.

- VBIOS Default        **Default**
- CRT
- IDP



### 5.4.1.2 PEG Port Configuration

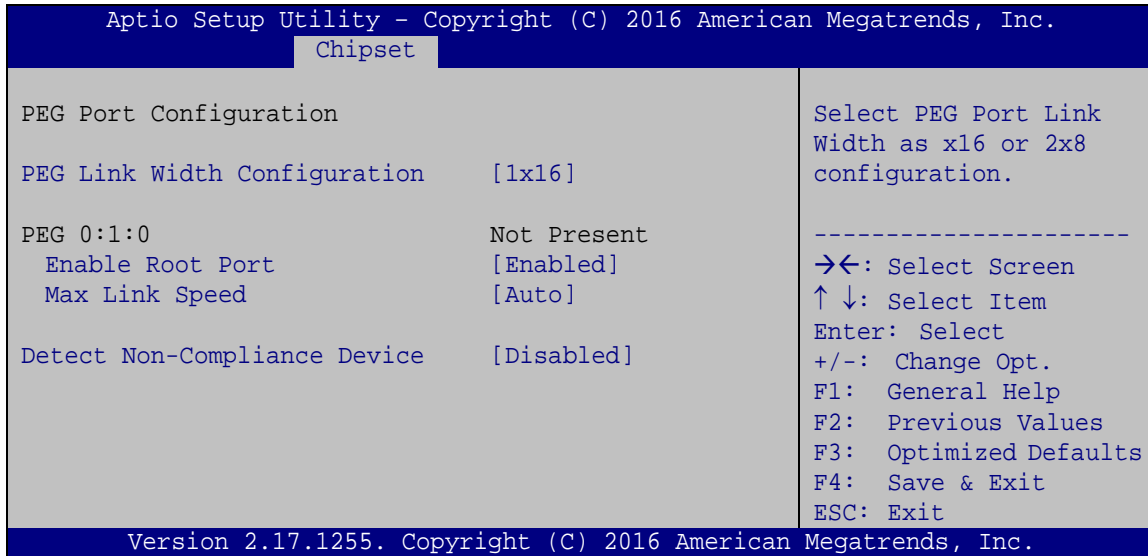

#### BIOS Menu 22: PEG Port Configuration

##### → PEG Link Width Configuration [1x16]

Use the **PEG Link Width Configuration** option to configure the PCIe x16 channel mode on the backplane.

- **1x16**                      **DEFAULT**      Sets the PCIe x16 link width as one PCIe x16 slot
- **2x8**                                      Sets the PCIe x16 link width as two PCIe x8 slots
- **1x8, 2x4**                                Sets the PCIe x16 link width as one PCIe x8 and two PCIe x4 slots

##### → Enable Root Port [Enabled]

Use the **Enable Root Port** option to enable or disable the PCI Express (PEG) controller.

- **Disabled**                                      Disables the PCI Express (PEG) controller.
- **Enabled**                                      **DEFAULT**      Enables the PCI Express (PEG) controller.

## SPCIE-C236 Full-size PICMG 1.3 CPU Card

### → Max Link Speed [Auto]

Use the **Max Link Speed** option to select the maximum link speed of the PCI Express slot.

The following options are available:

- Auto                      **Default**
- Gen1
- Gen2
- Gen3

### → Detect Non-Compliance Device [Disabled]

Use the **Detect Non-Compliance Device** option to enable or disable detecting if a non-compliance PCI Express device is connected to the PCI Express slot.

- **Disabled**                      **DEFAULT**      Disables to detect if a non-compliance PCI Express device is connected to the PCI Express slot.
- **Enabled**                              Enables to detect if a non-compliance PCI Express device is connected to the PCI Express slot.

### 5.4.1.3 Memory Configuration

Use the **Memory Configuration** submenu (**BIOS Menu 23**) to view memory information.

```

Aptio Setup Utility - Copyright (C) 2016 American Megatrends, Inc.
Chipset
Memory Configuration
Total Memory          8192 MB
DIMM#0                8192 MB
DIMM#1                Not Present
DIMM#2                Not Present
DIMM#3                Not Present
-----
→←: Select Screen
↑↓: Select Item
Enter: Select
+/-: Change Opt.
F1: General Help
F2: Previous Values
F3: Optimized Defaults
F4: Save & Exit
ESC: Exit
Version 2.17.1255. Copyright (C) 2016 American Megatrends, Inc.

```

**BIOS Menu 23: Memory Configuration**

### 5.4.2 PCH-IO Configuration

Use the **PCH-IO Configuration** menu (**BIOS Menu 24**) to configure the PCH parameters.

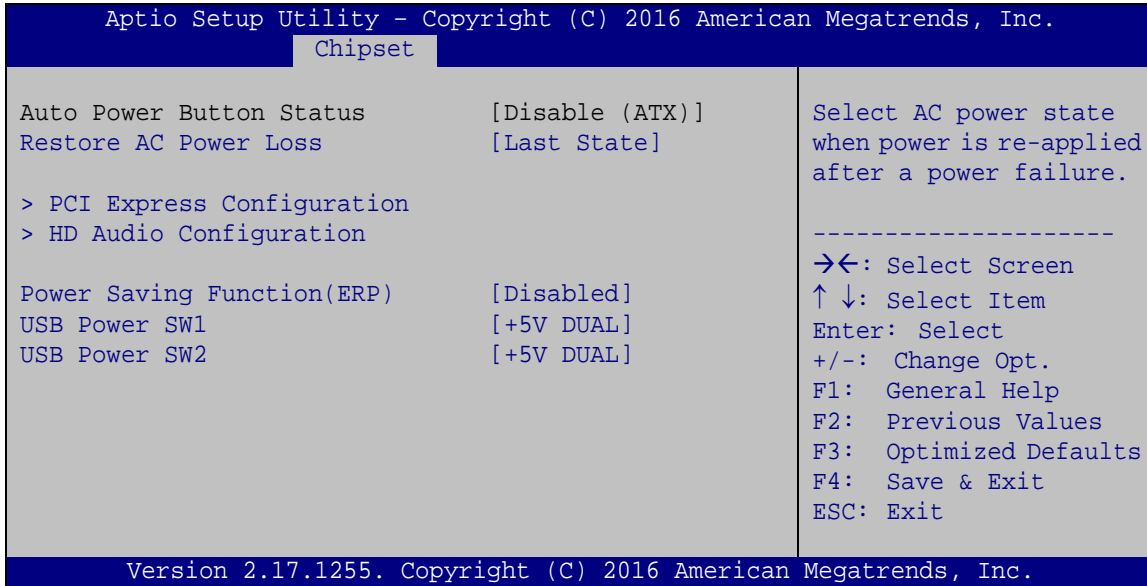

#### BIOS Menu 24: PCH-IO Configuration

##### → Restore AC Power Loss [Last State]

Use the **Restore AC Power Loss** BIOS option to specify what state the system returns to if there is a sudden loss of power to the system.

- **Power Off**                      The system remains turned off
- **Power On**                        The system turns on
- **Last State**    **DEFAULT**    The system returns to its previous state. If it was on, it turns itself on. If it was off, it remains off.

##### → Power Saving Function(ERP) [Disabled]

Use the **Power Saving Function(ERP)** BIOS option to enable or disable the power saving function.

- **Disabled**    **DEFAULT**    Power saving function is disabled.
- **Enabled**                      Power saving function is enabled. It will reduce power consumption when the system is off.

## SPCIE-C236 Full-size PICMG 1.3 CPU Card

### → USB Power SW1 [+5V DUAL]

Use the **USB Power SW1** BIOS option to configure the USB power source for the corresponding USB connectors (**Table 5-2**).

- **+5V** Sets the USB power source to +5V
- **+5V DUAL** **DEFAULT** Sets the USB power source to +5V dual

### → USB Power SW2 [+5V DUAL]

Use the **USB Power SW2** BIOS option to configure the USB power source for the corresponding USB connectors (**Table 5-2**).

- **+5V** Sets the USB power source to +5V
- **+5V DUAL** **DEFAULT** Sets the USB power source to +5V dual

BIOS Options	Configured USB Ports
USB Power SW1	USB3_1 (external USB 3.2 Gen 1 port) USB3_2 (external USB 3.2 Gen 1 port) USB4 (internal USB 2.0 port, Type A)
USB Power SW2	USB1 (internal USB 2.0 ports) USB2 (internal USB 2.0 ports) USB3 (internal USB 2.0 ports) USB3_34 (internal USB 3.2 Gen 1 ports)

**Table 5-2: BIOS Options and Configured USB Ports**

### 5.4.2.1 PCI Express Configuration

The PCI Express port number in the **PCI Express Configuration** menu varies by BIOS (BIOS1 or BIOS2). For detailed information, please refer to **Section 4.9.3**.

**For BIOS1:**

```

Aptio Setup Utility - Copyright (C) 2016 American Megatrends, Inc.
Chipset
-----
PCI Express Configuration
(BIOS No.1)
> PCIEX1_1 Slot
> PCIEX1_2 Slot
> PCIEX1_3 Slot
> PCIEX1_4 Slot
> MPCIE Slot

PCIEX1 Slot Settings.
-----
-><: Select Screen
↑↓: Select Item
Enter: Select
+/-: Change Opt.
F1: General Help
F2: Previous Values
F3: Optimized Defaults
F4: Save & Exit
ESC: Exit

Version 2.17.1255. Copyright (C) 2016 American Megatrends, Inc.
    
```

**BIOS Menu 25: PCI Express Configuration (For BIOS1)**

**For BIOS2:**

```

Aptio Setup Utility - Copyright (C) 2016 American Megatrends, Inc.
Chipset
-----
PCI Express Configuration
(BIOS No.2)
> PCIEX4 Slot
> MPCIE Slot

PCIEX4 Slot Settings.
-----
-><: Select Screen
↑↓: Select Item
Enter: Select
+/-: Change Opt.
F1: General Help
F2: Previous Values
F3: Optimized Defaults
F4: Save & Exit
ESC: Exit

Version 2.17.1255. Copyright (C) 2016 American Megatrends, Inc.
    
```

**BIOS Menu 26: PCI Express Configuration (For BIOS2)**



## SPCIE-C236 Full-size PICMG 1.3 CPU Card

### 5.4.2.1.1 PCIEX1 Slot/PCIEX4 Slot/MPCIE Slot

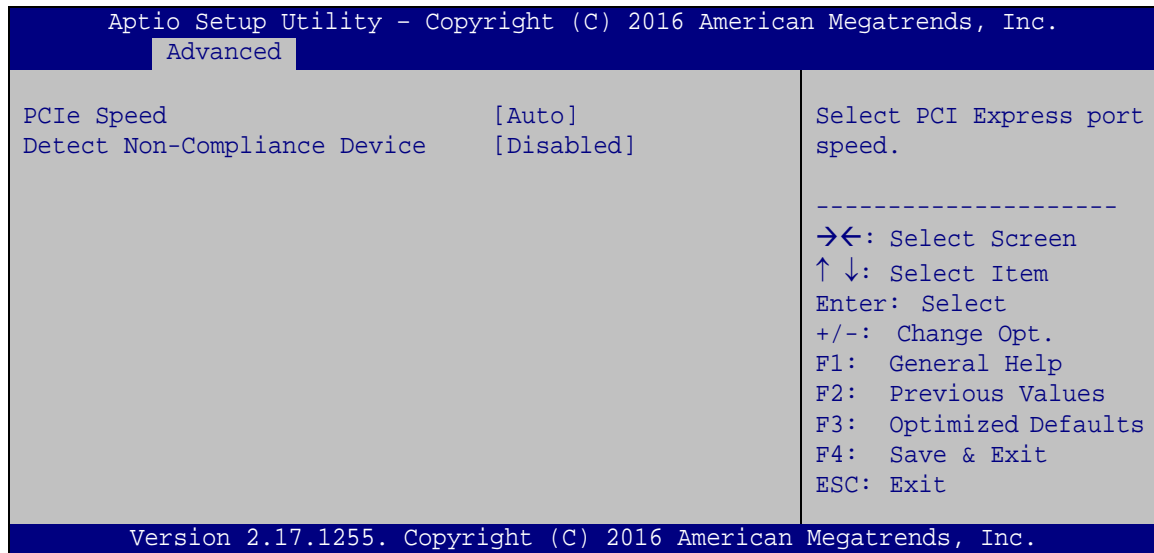

#### BIOS Menu 27: PCIEX1 Slot/PCIEX4 Slot/MPCIE Slot

##### → PCIe Speed [Auto]

Use this option to select the support type of the PCI Express slots. The following options are available:

- Auto                      **Default**
- Gen1
- Gen2
- Gen3

##### → Detect Non-Compliance Device [Disabled]

Use the **Detect Non-Compliance Device** option to enable or disable detecting if a non-compliance PCI Express device is connected to the PCI Express slot.

- **Disabled**                      **DEFAULT**      Disables to detect if a non-compliance PCI Express device is connected to the PCI Express slot.
- **Enabled**                              Enables to detect if a non-compliance PCI Express device is connected to the PCI Express slot.

### 5.4.2.2 HD Audio Configuration

Use the **HD Audio Configuration** menu (**BIOS Menu 28**) to configure the PCH Azalia settings.

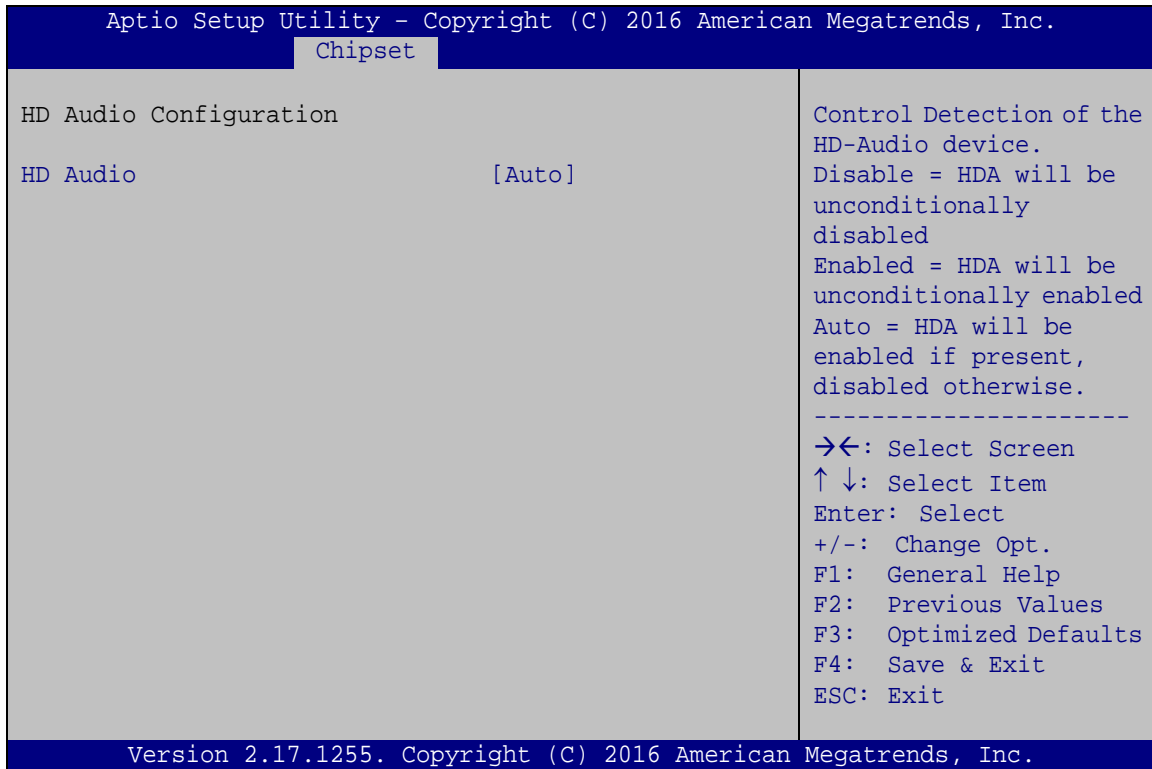

#### BIOS Menu 28: HD Audio Configuration

##### → HD Audio [Auto]

Use the **HD Audio** option to enable or disable the High Definition Audio controller.

- **Disabled**                      The onboard High Definition Audio controller is disabled.
- **Enabled**                        The onboard High Definition Audio controller is enabled.
- **Auto**                      **DEFAULT**      The onboard High Definition Audio controller automatically detected and enabled

## SPCIE-C236 Full-size PICMG 1.3 CPU Card

### 5.5 Security

Use the **Security** menu (**BIOS Menu 29**) to set system and user passwords.

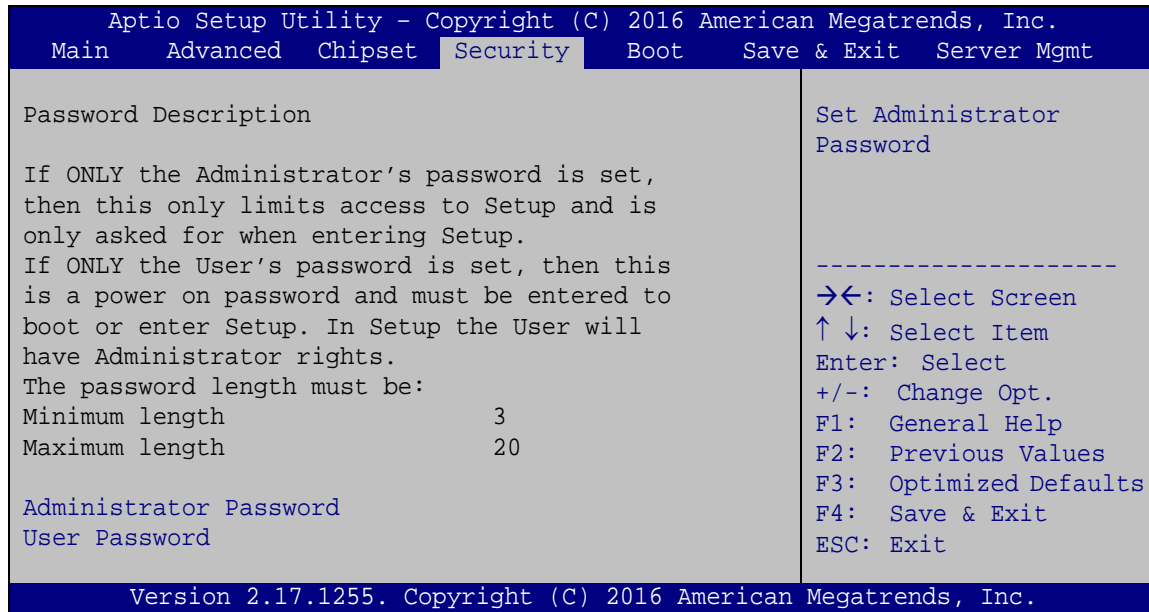

#### BIOS Menu 29: Security

##### → Administrator Password

Use the **Administrator Password** to set or change a administrator password.

##### → User Password

Use the **User Password** to set or change a user password.

## 5.6 Boot

Use the **Boot** menu (**BIOS Menu 30**) to configure system boot options.

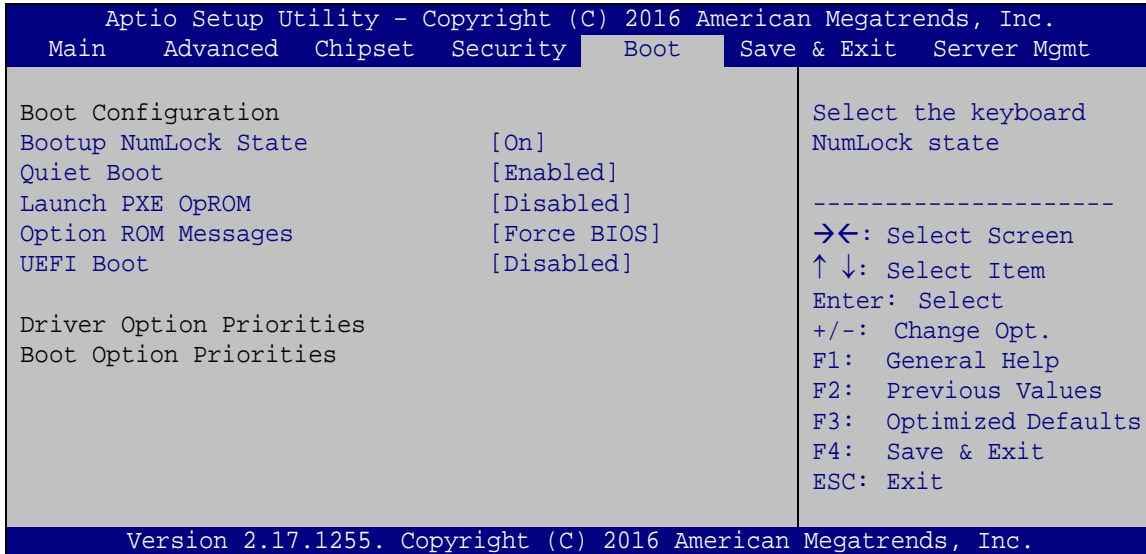

### BIOS Menu 30: Boot

#### → Bootup NumLock State [On]

Use the **Bootup NumLock State** BIOS option to specify if the number lock setting must be modified during boot up.

- **On**                      **DEFAULT**                      Allows the Number Lock on the keyboard to be enabled automatically when the computer system boots up. This allows the immediate use of the 10-key numeric keypad located on the right side of the keyboard. To confirm this, the Number Lock LED light on the keyboard is lit.
  
- **Off**                                      Does not enable the keyboard Number Lock automatically. To use the 10-keys on the keyboard, press the Number Lock key located on the upper left-hand corner of the 10-key pad. The Number Lock LED on the keyboard lights up when the Number Lock is engaged.

## SPCIE-C236 Full-size PICMG 1.3 CPU Card

### → Quiet Boot [Enabled]

Use the **Quiet Boot** BIOS option to select the screen display when the system boots.

- **Disabled** Normal POST messages displayed
- **Enabled**     **DEFAULT**     OEM Logo displayed instead of POST messages

### → Launch PXE OpROM [Disabled]

Use the **Launch PXE OpROM** option to enable or disable boot option for legacy network devices.

- **Disabled**     **DEFAULT**     Ignore all PXE Option ROMs
- **Enabled**                     Load PXE Option ROMs.

### → Option ROM Messages [Force BIOS]

Use the **Option ROM Messages** option to set the Option ROM display mode.

- **Force BIOS**     **DEFAULT**     Sets display mode to force BIOS.
- **Keep Current**                     Sets display mode to current.

### → UEFI Boot [Disabled]

Use the **UEFI Boot** option to enable or disable to boot from the UEFI devices.

- **Enabled**                     Boot from UEFI devices is enabled.
- **Disabled**     **DEFAULT**     Boot from UEFI devices is disabled.



## 5.7 Save & Exit

Use the **Safe & Exit** menu (**BIOS Menu 31**) to load default BIOS values, optimal failsafe values and to save configuration changes.

```

Aptio Setup Utility - Copyright (C) 2016 American Megatrends, Inc.
Main  Advanced  Chipset  Security  Boot  Save & Exit  Server Mgmt
-----
Save Changes and Reset
Discard Changes and Reset

Restore Defaults
Save as User Defaults
Restore User Defaults

Exit the system after
saving the changes.

-----
-><: Select Screen
↑ ↓: Select Item
Enter: Select
+/-: Change Opt.
F1: General Help
F2: Previous Values
F3: Optimized Defaults
F4: Save & Exit
ESC: Exit

Version 2.17.1255. Copyright (C) 2016 American Megatrends, Inc.

```

### BIOS Menu 31: Save & Exit

#### → Save Changes and Reset

Use the **Save Changes and Reset** option to save the changes made to the BIOS options and reset the system.

#### → Discard Changes and Reset

Use the **Discard Changes and Reset** option to exit the system without saving the changes made to the BIOS configuration setup program.

#### → Restore Defaults

Use the **Restore Defaults** option to load the optimal default values for each of the parameters on the Setup menus. **F3 key can be used for this operation.**

#### → Save as User Defaults

Use the **Save as User Defaults** option to save the changes done so far as user defaults.

#### → Restore User Defaults

Use the **Restore User Defaults** option to restore the user defaults to all the setup options.

## SPCIE-C236 Full-size PICMG 1.3 CPU Card

### 5.8 Server Mgmt (SPCIE-C236-i2 Only)

Use the **Server Mgmt** menu (**BIOS Menu 32**) to configure system event log and BMC network parameters.

```

Aptio Setup Utility - Copyright (C) 2016 American Megatrends, Inc.
Main   Advanced  Chipset  Security  Boot   Save & Exit  Server Mgmt
-----
BMC Self Test Status          FAILED
BMC Firmware Revision        Unknown
> System Event Log
> BMC network configuration

Press <Enter> to change
the SEL event log
configuration.

-----
-><: Select Screen
↑↓: Select Item
Enter: Select
+/-: Change Opt.
F1: General Help
F2: Previous Values
F3: Optimized Defaults
F4: Save & Exit
ESC: Exit

Version 2.17.1255. Copyright (C) 2016 American Megatrends, Inc.

```

**BIOS Menu 32: Server Mgmt**

#### 5.8.1 System Event Log

Use the **System Event Log** menu (**BIOS Menu 33**) to configure system event log options.

```

Aptio Setup Utility - Copyright (C) 2016 American Megatrends, Inc.
-----
Enabling/Disabling Options
SEL Components                [Enabled]

Erasing Settings
Erase SEL                     [No]
When SEL is Full              [Do Nothing]

NOTE: All values changed here do not take effect
      until computer is restarted.

Change this to enable or
disable all features of
System Event Logging
during boot.

-----
-><: Select Screen
↑↓: Select Item
Enter: Select
+/-: Change Opt.
F1: General Help
F2: Previous Values
F3: Optimized Defaults
F4: Save & Exit
ESC: Exit

Version 2.17.1255. Copyright (C) 2016 American Megatrends, Inc.

```

**BIOS Menu 33: System Event Log**

### → SEL Components [Enabled]

Use the **SEL Components** option to enable or disable all features of System Event Log during boot.

- **Disabled** System Event Log features disabled.
- **Enabled** **DEFAULT** System Event Log features enabled.

### → Erase SEL [No]

Use the **Erase SEL** option to select an option for erasing SEL (system event log).

- **No** **DEFAULT** Do not erase SEL
- **Yes, On next reset** Erase SEL on next reset
- **Yes, On every reset** Erase SEL on every reset

### → When SEL is Full [Do Nothing]

Use the **When SEL is Full** option to select an option for reaction to a full SEL.

- **Do Nothing** **DEFAULT** Do nothing when SEL is full
- **Erase Immediately** Erase SEL immediately when SEL is full

## SPCIE-C236 Full-size PICMG 1.3 CPU Card

### 5.8.2 BMC Network Configuration

Use the **BMC Network Configuration** menu (**BIOS Menu 34**) to configure BMC network parameters.

```

Aptio Setup Utility - Copyright (C) 2016 American Megatrends, Inc.
Server Mgmt
BMC network configuration
Lan channel 1
Configuration Address source [Unspecified]
Current Configuration address source -
Station IP address -
Subnet mask -
Station MAC address -
Router IP address -
Router MAC address -
Select to configure LAN channel parameters statically or dynamically (by BIOS or BMC). Unspecified option will not modify any BMC network parameters during BIOS phase.
-----
-><: Select Screen
↑↓: Select Item
Enter: Select
+/-: Change Opt.
F1: General Help
F2: Previous Values
F3: Optimized Defaults
F4: Save & Exit
ESC: Exit
Version 2.17.1255. Copyright (C) 2016 American Megatrends, Inc.
  
```

#### BIOS Menu 34: System Event Log

##### → Configuration Address source [Unspecified]

Use the **Configuration Address source** to configure LAN channel parameters statically or dynamically (by BIOS or BMC).

- **Unspecified**                      **DEFAULT**      BMC network parameters will not be modified during BIOS phase.
- **Static**    Select to modify the following BMC network parameters:
  - Station IP address
  - Subnet mask
  - Station MAC address
  - Router IP address
  - Router MAC address

- **DynamicBmcDhcp**                      Select to configure LAN channel parameters dynamically by BMC
  
- **DynamicBmcNonDhcp**              Select to configure LAN channel parameters dynamically by BIOS



Chapter

**6**

# Software Drivers

---

## 6.1 Available Drivers

All the drivers for the SPCIE-C236 are available on IEI Resource Download Center (<https://download.ieiworld.com>). Type SPCIE-C236 and press Enter to find all the relevant software, utilities, and documentation.

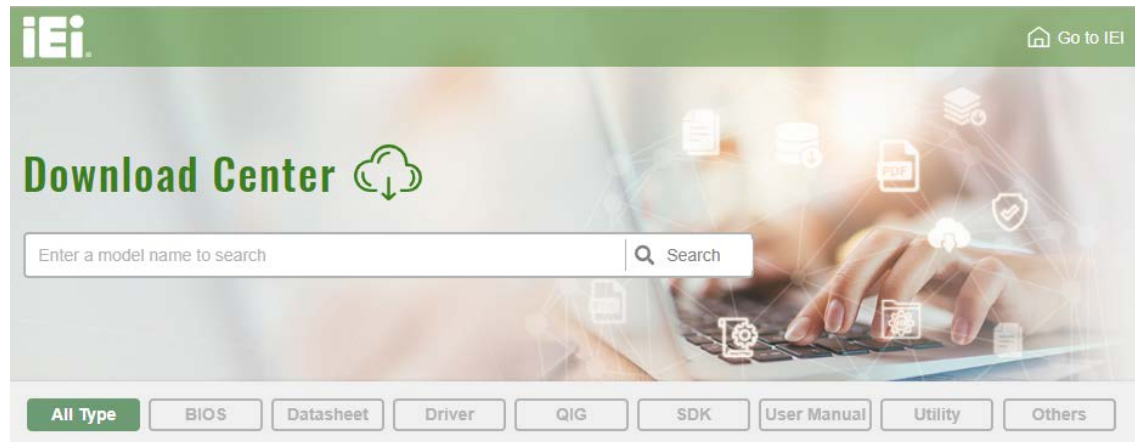
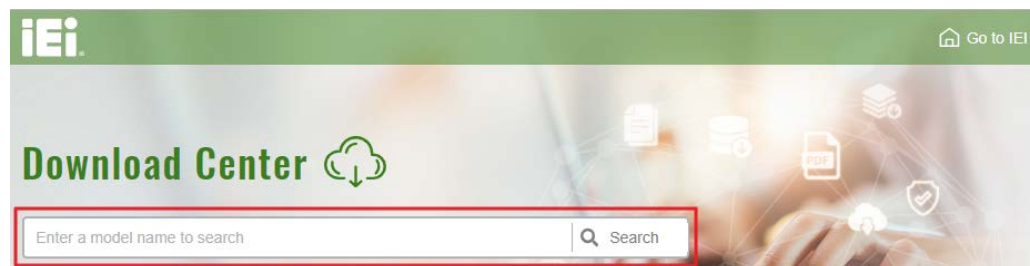

Figure 6-1: IEI Resource Download Center

## 6.2 Driver Download

To download drivers from IEI Resource Download Center, follow the steps below.

**Step 1:** Go to <https://download.ieiworld.com>. Type SPCIE-C236 and press Enter.



**Step 2:** All product-related software, utilities, and documentation will be listed. You can choose **Driver** to filter the result.

## SPCIE-C236 Full-size PICMG 1.3 CPU Card

[All Type](#)
[BIOS](#)
[Datasheet](#)
[Driver](#)
[QIG](#)
[SDK](#)
[User Manual](#)
[Utility](#)
[Others](#)

Keyword: "PCIE-Q170", Searching Result : 32 Records.

**HPCIE-Q170** [Product Info](#)

[Embedded Computer](#) > [Single Board Computer](#) > [Half Size Single Board Computer](#)

Half-size PICMG 1.3 CPU Card supports LGA 1151 Intel® Core™ i7/i5/i3, Pentium® or Celeron® CPU with Intel® Q170.

**Driver**

File Name	Published	Version	File Checksum
<a href="#">7B000-001167-RS_V1.8.iso (1.13 GB)</a>	2017/10/16	1.80	114B70CE3AE5F6E58D3E61586F2D255A

**Step 3:** Click the driver file name on the page and you will be prompted with the following window. You can download the entire ISO file (❶), or double click an individual item to find its driver file and click the file name to download (❷).

**7B000-001167-RS\_V1.8.iso**

Click here to download entire ISO file. (1.13 GB)

\* Download individual file \*

- 1.Chipset
- 2.VGA
- 3.LAN
- 3.LAN(IMB-H110)
- 4.Audio
- 5.USB3.0
- 6.KMDF
- 7.ME
- 8.RST
- 9.Serial IO
- A.Manual



### NOTE:

To install software from the downloaded ISO image file in Windows 8, 8.1 or 10, double-click the ISO file to mount it as a virtual drive to view its content. On Windows 7 system, an additional tool (such as Virtual CD-ROM Control Panel from Microsoft) is needed to mount the file.

Appendix

**A**

# Regulatory Compliance

---

## SPCIE-C236 Full-size PICMG 1.3 CPU Card

### DECLARATION OF CONFORMITY



This equipment has been tested and found to comply with specifications for CE marking. If the user modifies and/or installs other devices in the equipment, the CE conformity declaration may no longer apply.

### FCC WARNING



This equipment complies with Part 15 of the FCC Rules. Operation is subject to the following two conditions:

- This device may not cause harmful interference, and
- This device must accept any interference received, including interference that may cause undesired operation.

This equipment has been tested and found to comply with the limits for a Class A digital device, pursuant to part 15 of the FCC Rules. These limits are designed to provide reasonable protection against harmful interference when the equipment is operated in a commercial environment. This equipment generates, uses, and can radiate radio frequency energy and, if not installed and used in accordance with the instruction manual, may cause harmful interference to radio communications. Operation of this equipment in a residential area is likely to cause harmful interference in which case the user will be required to correct the interference at his own expense.



Appendix

**B**

# Product Disposal

---

## SPCIE-C236 Full-size PICMG 1.3 CPU Card

**CAUTION:**

Risk of explosion if battery is replaced by an incorrect type. Only certified engineers should replace the on-board battery.

Dispose of used batteries according to instructions and local regulations.

---

- Outside the European Union – If you wish to dispose of used electrical and electronic products outside the European Union, please contact your local authority so as to comply with the correct disposal method.
- Within the European Union – The device that produces less waste and is easier to recycle is classified as electronic device in terms of the European Directive 2012/19/EU (WEEE), and must not be disposed of as domestic garbage.

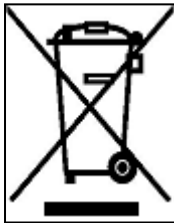

EU-wide legislation, as implemented in each Member State, requires that waste electrical and electronic products carrying the mark (left) must be disposed of separately from normal household waste. This includes monitors and electrical accessories, such as signal cables or power cords. When you need to dispose of your device, please follow the guidance of your local authority, or ask the shop where you purchased the product. The mark on electrical and electronic products only applies to the current European Union Member States.

Please follow the national guidelines for electrical and electronic product disposal.

Appendix

**C**

# BIOS Options

---

## SPCIE-C236 Full-size PICMG 1.3 CPU Card

Below is a list of BIOS configuration options in the BIOS chapter.

<input type="checkbox"/>	<b>System Date [xx/xx/xx]</b> .....	<b>80</b>
<input type="checkbox"/>	<b>System Time [xx:xx:xx]</b> .....	<b>80</b>
<input type="checkbox"/>	<b>Security Device Support [Disable]</b> .....	<b>81</b>
<input type="checkbox"/>	<b>ACPI Sleep State [S3 (Suspend to RAM)]</b> .....	<b>82</b>
<input type="checkbox"/>	<b>Intel AMT [Enabled]</b> .....	<b>83</b>
<input type="checkbox"/>	<b>Un-Configure ME [Disabled]</b> .....	<b>83</b>
<input type="checkbox"/>	<b>Case Open Detection [Disabled]</b> .....	<b>84</b>
<input type="checkbox"/>	<b>Serial Port [Enabled]</b> .....	<b>85</b>
<input type="checkbox"/>	<b>Change Settings [Auto]</b> .....	<b>85</b>
<input type="checkbox"/>	<b>Serial Port [Enabled]</b> .....	<b>86</b>
<input type="checkbox"/>	<b>Change Settings [Auto]</b> .....	<b>86</b>
<input type="checkbox"/>	<b>Serial Port [Enabled]</b> .....	<b>87</b>
<input type="checkbox"/>	<b>Change Settings [Auto]</b> .....	<b>87</b>
<input type="checkbox"/>	<b>Transfer Mode [RS232]</b> .....	<b>88</b>
<input type="checkbox"/>	<b>Serial Port [Enabled]</b> .....	<b>88</b>
<input type="checkbox"/>	<b>Change Settings [Auto]</b> .....	<b>88</b>
<input type="checkbox"/>	<b>Transfer Mode [RS232]</b> .....	<b>89</b>
<input type="checkbox"/>	<b>Parallel Port [Enabled]</b> .....	<b>90</b>
<input type="checkbox"/>	<b>Device Mode [STD Printer Mode]</b> .....	<b>90</b>
<input type="checkbox"/>	<b>PC Health Status</b> .....	<b>91</b>
<input type="checkbox"/>	<b>CPU_FAN1 Smart Fan Control/SYS_FAN1 Smart Fan Control [Auto Mode]</b> .....	<b>92</b>
<input type="checkbox"/>	<b>Auto mode fan start/off temperature</b> .....	<b>92</b>
<input type="checkbox"/>	<b>Auto mode fan start PWM</b> .....	<b>92</b>
<input type="checkbox"/>	<b>Auto mode fan slope PWM</b> .....	<b>93</b>
<input type="checkbox"/>	<b>Wake system with Fixed Time [Disabled]</b> .....	<b>93</b>
<input type="checkbox"/>	<b>Console Redirection [Disabled]</b> .....	<b>95</b>
<input type="checkbox"/>	<b>Terminal Type [ANSI]</b> .....	<b>95</b>
<input type="checkbox"/>	<b>Bits per second [115200]</b> .....	<b>95</b>
<input type="checkbox"/>	<b>Data Bits [8]</b> .....	<b>95</b>
<input type="checkbox"/>	<b>Parity [None]</b> .....	<b>96</b>
<input type="checkbox"/>	<b>Stop Bits [1]</b> .....	<b>96</b>
<input type="checkbox"/>	<b>Legacy Serial Redirection Port [COM1]</b> .....	<b>97</b>
<input type="checkbox"/>	<b>Hyper-threading [Enabled]</b> .....	<b>98</b>

<input type="checkbox"/>	Active Processor Cores [All] .....	99
<input type="checkbox"/>	Intel Virtualization Technology [Disabled] .....	99
<input type="checkbox"/>	Intel(R) SpeedStep(tm) [Enabled].....	99
<input type="checkbox"/>	CPU C states [Disabled].....	99
<input type="checkbox"/>	Intel TXT(LT) Support [Disabled].....	100
<input type="checkbox"/>	SATA Controller(s) [Enabled] .....	100
<input type="checkbox"/>	SATA Mode Selection [AHCI].....	100
<input type="checkbox"/>	Hot Plug [Disabled].....	101
<input type="checkbox"/>	Legacy USB Support [Enabled].....	102
<input type="checkbox"/>	Auto Recovery Function [Disabled].....	103
<input type="checkbox"/>	VT-d [Disabled].....	105
<input type="checkbox"/>	Primary Display [Auto] .....	106
<input type="checkbox"/>	Internal Graphics [Enabled].....	106
<input type="checkbox"/>	DVMT Pre-Allocated [32M] .....	107
<input type="checkbox"/>	DVMT Total Gfx Mem [MAX].....	107
<input type="checkbox"/>	Primary IGFX Boot Display [VBIOS Default] .....	107
<input type="checkbox"/>	PEG Link Width Configuration [1x16].....	108
<input type="checkbox"/>	Enable Root Port [Enabled] .....	108
<input type="checkbox"/>	Max Link Speed [Auto] .....	109
<input type="checkbox"/>	Detect Non-Compliance Device [Disabled] .....	109
<input type="checkbox"/>	Restore AC Power Loss [Last State] .....	110
<input type="checkbox"/>	Power Saving Function(ERP) [Disabled].....	110
<input type="checkbox"/>	USB Power SW1 [+5V DUAL].....	111
<input type="checkbox"/>	USB Power SW2 [+5V DUAL].....	111
<input type="checkbox"/>	PCIe Speed [Auto].....	113
<input type="checkbox"/>	Detect Non-Compliance Device [Disabled] .....	113
<input type="checkbox"/>	HD Audio [Auto].....	114
<input type="checkbox"/>	Administrator Password .....	115
<input type="checkbox"/>	User Password .....	115
<input type="checkbox"/>	Bootup NumLock State [On].....	116
<input type="checkbox"/>	Quiet Boot [Enabled] .....	117
<input type="checkbox"/>	Launch PXE OpROM [Disabled].....	117
<input type="checkbox"/>	Option ROM Messages [Force BIOS].....	117
<input type="checkbox"/>	UEFI Boot [Disabled] .....	117
<input type="checkbox"/>	Save Changes and Reset .....	118



## SPCIE-C236 Full-size PICMG 1.3 CPU Card

<input type="checkbox"/> Discard Changes and Reset .....	118
<input type="checkbox"/> Restore Defaults .....	118
<input type="checkbox"/> Save as User Defaults .....	118
<input type="checkbox"/> Restore User Defaults .....	118
<input type="checkbox"/> SEL Components [Enabled].....	120
<input type="checkbox"/> Erase SEL [No] .....	120
<input type="checkbox"/> When SEL is Full [Do Nothing].....	120
<input type="checkbox"/> Configuration Address source [Unspecified] .....	121

Appendix

**D**

# Digital I/O Interface

---

## SPCIE-C236 Full-size PICMG 1.3 CPU Card

### D.1 Introduction

The DIO connector on the SPCIE-C236 is interfaced to GPIO ports on the Super I/O chipset. The digital inputs and digital outputs are generally control signals that control the on/off circuit of external devices or TTL devices. Data can be read or written to the selected address to enable the DIO functions.



#### NOTE:

For further information, please refer to the datasheet for the Super I/O chipset.

---

The BIOS interrupt call **INT 15H** controls the digital I/O.

#### INT 15H:

<b>AH – 6FH</b>	
<u>Sub-function:</u>	
<b>AL – 8</b>	: Set the digital port as INPUT
<b>AL</b>	: Digital I/O input value

## D.2 Assembly Language Sample 1

```
MOV     AX, 6F08H      ;setting the digital port as input
INT     15H            ;
```

AL low byte = value

AH – 6FH
Sub-function:
AL – 9 : Set the digital port as OUTPUT
BL : Digital I/O input value

## D.3 Assembly Language Sample 2

```
MOV     AX, 6F09H      ;setting the digital port as output
MOV     BL, 09H        ;digital value is 09H
INT     15H            ;
```

Digital Output is 1001b

Appendix

**E**

# Watchdog Timer

---





**NOTE:**

The following discussion applies to DOS environment. Contact IEI support or visit the IEI website for specific drivers for other operating systems.

The Watchdog Timer is provided to ensure that standalone systems can always recover from catastrophic conditions that cause the CPU to crash. This condition may have occurred by external EMIs or a software bug. When the CPU stops working correctly, Watchdog Timer either performs a hardware reset (cold boot) or a Non-Maskable Interrupt (NMI) to bring the system back to a known state.

A BIOS function call (INT 15H) is used to control the Watchdog Timer.

INT 15H:

<b>AH – 6FH Sub-function:</b>	
AL – 2:	Sets the Watchdog Timer's period.
BL:	Time-out value (Its unit-second is dependent on the item "Watchdog Timer unit select" in CMOS setup).

**Table E-1: AH-6FH Sub-function**

Call sub-function 2 to set the time-out period of Watchdog Timer first. If the time-out value is not zero, the Watchdog Timer starts counting down. When the timer value reaches zero, the system resets. To ensure that this reset condition does not occur, calling sub-function 2 must periodically refresh the Watchdog Timer. However, the watchdog timer is disabled if the time-out value is set to zero.

A tolerance of at least 10% must be maintained to avoid unknown routines within the operating system (DOS), such as disk I/O that can be very time-consuming.

## SPCIE-C236 Full-size PICMG 1.3 CPU Card

**NOTE:**

When exiting a program it is necessary to disable the Watchdog Timer, otherwise the system resets.

**EXAMPLE PROGRAM:**

**; INITIAL TIMER PERIOD COUNTER**

;

**W\_LOOP:**

;

```

MOV      AX, 6F02H      ;setting the time-out value
MOV      BL, 30         ;time-out value is 48 seconds
INT      15H

```

;

**; ADD THE APPLICATION PROGRAM HERE**

;

```

CMP      EXIT_AP, 1     ;is the application over?
JNE      W_LOOP        ;No, restart the application

```

```

MOV      AX, 6F02H     ;disable Watchdog Timer
MOV      BL, 0        ;
INT      15H

```

;

**; EXIT ;**

Appendix

**F**

# Error Beep Code

---

## SPCIE-C236 Full-size PICMG 1.3 CPU Card

## F.1 PEI Beep Codes

Number of Beeps	Description
1	Memory not Installed
1	Memory was installed twice (InstallPeiMemory routine in PEI Core called twice)
2	Recovery started
3	DXE IPL was not found
3	DXE Core Firmware Volume was not found
4	Recovery failed
4	S3 Resume failed
7	Reset PPI is not available

## F.2 DXE Beep Codes

Number of Beeps	Description
1	Invalid password
4	Some of the Architectural Protocols are not available
5	No Console Output Devices are found
5	No Console Input Devices are found
6	Flash update is failed
7	Reset protocol is not available
8	Platform PCI resource requirements cannot be met

**NOTE:**

If you have any question, please contact IEI for further assistance.

Appendix

**G**

# Hazardous Materials Disclosure

---



## SPCIE-C236 Full-size PICMG 1.3 CPU Card

### G.1 RoHS II Directive (2015/863/EU)

The details provided in this appendix are to ensure that the product is compliant with the RoHS II Directive (2015/863/EU). The table below acknowledges the presences of small quantities of certain substances in the product, and is applicable to RoHS II Directive (2015/863/EU).

Please refer to the following table.

Part Name	Toxic or Hazardous Substances and Elements									
	Lead (Pb)	Mercury (Hg)	Cadmium (Cd)	Hexavalent Chromium (CR(VI))	Polybrominated Biphenyls (PBB)	Polybrominated Diphenyl Ethers (PBDE)	Bis(2-ethylhexyl) phthalate (DEHP)	Butyl benzyl phthalate (BBP)	Dibutyl phthalate (DBP)	Diisobutyl phthalate (DIBP)
Housing	O	O	O	O	O	O	O	O	O	O
Display	O	O	O	O	O	O	O	O	O	O
Printed Circuit Board	O	O	O	O	O	O	O	O	O	O
Metal Fasteners	O	O	O	O	O	O	O	O	O	O
Cable Assembly	O	O	O	O	O	O	O	O	O	O
Fan Assembly	O	O	O	O	O	O	O	O	O	O
Power Supply Assemblies	O	O	O	O	O	O	O	O	O	O
Battery	O	O	O	O	O	O	O	O	O	O

O: This toxic or hazardous substance is contained in all of the homogeneous materials for the part is below the limit requirement in Directive (EU) 2015/863.

X: This toxic or hazardous substance is contained in at least one of the homogeneous materials for this part is above the limit requirement in Directive (EU) 2015/863.

## G.2 China RoHS

此附件旨在确保本产品符合中国 RoHS 标准。以下表格标示此产品中某有毒物质的含量符合中国 RoHS 标准规定的限量要求。

本产品上会附有“环境友好使用期限”的标签，此期限是估算这些物质“不会有泄漏或突变”的年限。本产品可能包含有较短的环境友好使用期限的可替换元件，像是电池或灯管，这些元件将会单独标示出来。

部件名称	有毒有害物质或元素					
	铅 (Pb)	汞 (Hg)	镉 (Cd)	六价铬 (CR(VI))	多溴联苯 (PBB)	多溴二苯醚 (PBDE)
壳体	○	○	○	○	○	○
显示	○	○	○	○	○	○
印刷电路板	○	○	○	○	○	○
金属螺帽	○	○	○	○	○	○
电缆组装	○	○	○	○	○	○
风扇组装	○	○	○	○	○	○
电力供应组装	○	○	○	○	○	○
电池	○	○	○	○	○	○

○: 表示该有毒有害物质在该部件所有物质材料中的含量均在 SJ/T11364-2014 與 GB/T26572-2011 标准规定的限量要求以下。

X: 表示该有毒有害物质至少在该部件的某一均质材料中的含量超出 SJ/T11364-2014 與 GB/T26572-2011 标准规定的限量要求。