

MODEL:
KINO-KBN-i2

**Mini-ITX SBC with AMD® G-Series SoC Processor,
DDR3, VGA/HDMI, Dual GbE, USB 3.0, Dual Mini PCIe,
SATA 6Gb/s, Audio and RoHS**

User Manual

Revision

Date	Version	Changes
June 24, 2021	1.10	Updated Section 2.3: Packing List Added Chapter 6: Software
August 15, 2017	1.03	Updated the memory spec
December 3, 2015	1.02	Added a note regarding how to use USB 3.0 ports for Windows 7 OS installation in Section 3.3.2 .
March 12, 2014	1.01	Added chassis intrusion connector (CHASSIS1) Added IPMI LED connector (ID_BT_FP1)
November 20, 2013	1.00	Initial release

Copyright

COPYRIGHT NOTICE

The information in this document is subject to change without prior notice in order to improve reliability, design and function and does not represent a commitment on the part of the manufacturer.

In no event will the manufacturer be liable for direct, indirect, special, incidental, or consequential damages arising out of the use or inability to use the product or documentation, even if advised of the possibility of such damages.

This document contains proprietary information protected by copyright. All rights are reserved. No part of this manual may be reproduced by any mechanical, electronic, or other means in any form without prior written permission of the manufacturer.

TRADEMARKS

All registered trademarks and product names mentioned herein are used for identification purposes only and may be trademarks and/or registered trademarks of their respective owners.

Manual Conventions



WARNING

Warnings appear where overlooked details may cause damage to the equipment or result in personal injury. Warnings should be taken seriously.



CAUTION

Cautionary messages should be heeded to help reduce the chance of losing data or damaging the product.



NOTE

These messages inform the reader of essential but non-critical information. These messages should be read carefully as any directions or instructions contained therein can help avoid making mistakes.



HOT SURFACE

This symbol indicates a hot surface that should not be touched without taking care.

Table of Contents

1 INTRODUCTION.....	1
1.1 INTRODUCTION.....	2
1.2 MODEL VARIATIONS	3
1.3 FEATURES.....	3
1.4 CONNECTORS	4
1.5 DIMENSIONS.....	5
1.6 DATA FLOW	6
1.7 TECHNICAL SPECIFICATIONS	7
2 UNPACKING	9
2.1 ANTI-STATIC PRECAUTIONS	10
2.2 UNPACKING PRECAUTIONS.....	10
2.3 PACKING LIST.....	11
2.4 OPTIONAL ITEMS	12
3 CONNECTORS	13
3.1 PERIPHERAL INTERFACE CONNECTORS.....	14
3.1.1 KINO-KBN-i2 Layout	14
3.1.2 Peripheral Interface Connectors	15
3.1.3 External Interface Panel Connectors.....	16
3.2 INTERNAL PERIPHERAL CONNECTORS	17
3.2.1 AT/ATX Mode Select Switch.....	17
3.2.2 Battery Connector.....	18
3.2.3 Chassis Intrusion Connector.....	19
3.2.4 Clear CMOS Button.....	20
3.2.5 CPU Fan Connector	21
3.2.6 CPU Power Connector	22
3.2.7 DDR3/DDR3L SO-DIMM Slots.....	23
3.2.8 Digital I/O Connector.....	24
3.2.9 EC Debug Connector.....	25
3.2.10 Front Panel Connector	26

3.2.11 IPMI LED Connector	27
3.2.12 IPMI Slot	28
3.2.13 Keyboard/Mouse Connector	31
3.2.14 LAN LED Connector	32
3.2.15 PCIe x4 Slot	32
3.2.16 PCIe Mini Card Slot	34
3.2.17 RS-232 Serial Port Connector	37
3.2.18 RS-422/485 Serial Port Connector	38
3.2.19 SATA 6Gb/s Drive Connector	39
3.2.20 SATA Power Connector	40
3.2.21 SD Card Slot	41
3.2.22 SMBUS Connector	42
3.2.23 S/PDIF Connector	43
3.2.24 SPI Flash Connector	44
3.2.25 System Fan Connector	45
3.2.26 TPM Connector	46
3.2.27 USB Connector	47
3.3 EXTERNAL PERIPHERAL INTERFACE CONNECTOR PANEL	48
3.3.1 Audio Connector	48
3.3.2 Ethernet and USB Connectors	49
3.3.3 HDMI Connector	51
3.3.4 Power Connector	52
3.3.5 Serial Port Connector (COM1)	53
3.3.6 VGA Connector	54
4 INSTALLATION	55
4.1 ANTI-STATIC PRECAUTIONS	56
4.2 INSTALLATION CONSIDERATIONS	56
4.2.1 SO-DIMM Installation	58
4.2.2 IPMI Module Installation (Optional)	59
4.3 INTERNAL PERIPHERAL DEVICE CONNECTIONS	60
4.3.1 SATA Drive Connection	60
4.3.2 Single RS-232 Cable	61
4.4 IPMI SETUP PROCEDURE	62
4.4.1 Managed System Hardware Setup	62

KINO-KBN-i2

4.4.2 Using the IEI iMAN Web GUI.....	62
5 BIOS	65
5.1 INTRODUCTION.....	66
5.1.1 Starting Setup.....	66
5.1.2 Using Setup	66
5.1.3 Getting Help.....	67
5.1.4 Unable to Reboot after Configuration Changes	67
5.1.5 BIOS Menu Bar.....	67
5.2 MAIN.....	68
5.3 ADVANCED.....	69
5.3.1 ACPI Settings.....	69
5.3.2 RTC Wake Settings.....	70
5.3.3 Trusted Computing.....	72
5.3.4 CPU Configuration.....	73
5.3.5 IDE Configuration.....	74
5.3.6 USB Configuration.....	75
5.3.7 F81866 Super IO Configuration.....	76
5.3.7.1 Serial Port n Configuration.....	77
5.3.7.1.1 Serial Port 1 Configuration.....	77
5.3.7.1.2 Serial Port 2 Configuration.....	78
5.3.7.1.3 Serial Port 3 Configuration.....	79
5.3.7.1.4 Serial Port 5 Configuration.....	80
5.3.7.1.5 Serial Port 6 Configuration.....	80
5.3.8 F81866 H/W Monitor.....	82
5.3.8.1 Smart Fan Mode Configuration.....	83
5.3.9 Serial Port Console Redirection.....	84
5.3.9.1 Console Redirection Settings.....	85
5.4 CHIPSET.....	88
5.4.1 GFX Configuration.....	88
5.4.2 South Bridge Configuration.....	89
5.4.3 North Bridge Configuration.....	91
5.5 BOOT.....	92
5.6 SECURITY.....	94
5.7 SAVE & EXIT.....	94

6 SOFTWARE	96
6.1 AVAILABLE DRIVERS	97
6.2 DRIVER DOWNLOAD	97
A REGULATORY COMPLIANCE	99
B PRODUCT DISPOSAL	101
C BIOS MENU OPTIONS	103
D DIGITAL I/O INTERFACE	106
E WATCHDOG TIMER	109
F ERROR BEEP CODE	112
F.1 PEI BEEP CODES	113
F.2 DXE BEEP CODES	113
G HAZARDOUS MATERIALS DISCLOSURE	114
G.1 RoHS II DIRECTIVE (2015/863/EU).....	115
G.2 CHINA RoHS	116

List of Figures

Figure 1-1: KINO-KBN-i2	2
Figure 1-2: Connectors	4
Figure 1-3: Dimensions (mm)	5
Figure 1-4: Data Flow Diagram	6
Figure 3-1: Connector and Jumper Locations	14
Figure 3-2: AT/ATX Mode Select Switch Location	17
Figure 3-3: Battery Connector Location	18
Figure 3-4: Chassis Intrusion Connector Location	19
Figure 3-5: Clear CMOS Button Location	20
Figure 3-6: CPU Fan Connector Locations	21
Figure 3-7: CPU Power Connector Location	22
Figure 3-8: DDR3/DDR3L SO-DIMM Slot Location	23
Figure 3-9: Digital I/O Connector Location	24
Figure 3-10: EC Debug Connector Location	25
Figure 3-11: Front Panel Connector Location	26
Figure 3-12: IPMI LED Connector Location	27
Figure 3-13: IPMI Slot Location	28
Figure 3-14: Keyboard/Mouse Connector Location	31
Figure 3-15: LAN LED Connector Location	32
Figure 3-16: PCIe x4 Slot Location	33
Figure 3-17: PCIe Mini Card Slot Location	35
Figure 3-18: RS-232 Serial Port Connector Location	37
Figure 3-19: RS-422/485 Connector Location	38
Figure 3-20: SATA 6Gb/s Drive Connector Location	39
Figure 3-21: SATA Power Connector Location	40
Figure 3-22: SD Card Slot Location	41
Figure 3-23: SMBus Connector Location	42
Figure 3-24: S/PDIF Connector Location	43
Figure 3-25: SPI Flash Connector Location	44
Figure 3-26: System Fan Connector Locations	45
Figure 3-27: TPM Connector Location	46

Figure 3-28: USB Connector Locations.....	47
Figure 3-29: External Peripheral Interface Connector	48
Figure 3-30: Audio Connector	48
Figure 3-31: LAN Connector	49
Figure 3-32: Power Connector (4-pin DIN)	52
Figure 3-33: Serial Port Pinout Locations	53
Figure 3-34: VGA Connector	54
Figure 4-1: SO-DIMM Installation	58
Figure 4-2: IPMI Module Installation	59
Figure 4-3: SATA Drive Cable Connection.....	60
Figure 4-4: Single RS-232 Cable Installation	61
Figure 4-5: IEI iMAN Web Address.....	63
Figure 4-6: IEI iMAN Web GUI.....	63
Figure 6-1: IEI Resource Download Center.....	97

List of Tables

Table 1-1: KINO-KBN-i2 Model Variations.....	3
Table 1-2: Technical Specifications.....	8
Table 3-1: Peripheral Interface Connectors.....	16
Table 3-2: Rear Panel Connectors.....	16
Table 3-3: AT/ATX Mode Select Switch Settings.....	17
Table 3-4: Battery Connector Pinouts.....	19
Table 3-5: Chassis Intrusion Connector Pinouts.....	19
Table 3-6: Clear CMOS Button Settings.....	20
Table 3-7: CPU Fan Connector Pinouts.....	21
Table 3-8: CPU Power Connector Pinouts.....	22
Table 3-9: Digital I/O Connector Pinouts.....	24
Table 3-10: EC Debug Connector Pinouts.....	25
Table 3-11: Front Panel Connector Pinouts.....	26
Table 3-12: IPMI LED Connector Pinouts.....	27
Table 3-13: IPMI Slot Pinouts.....	30
Table 3-14: Keyboard/Mouse Connector Pinouts.....	31
Table 3-15: LAN LED Connector Pinouts.....	32
Table 3-16: PCIe x4 Slot Pinouts.....	34
Table 3-17: PCIe Mini Card Slot Pinouts (M_PCIE1).....	36
Table 3-18: PCIe Mini Card Slot Pinouts (M_PCIE2).....	37
Table 3-19: RS-232 Serial Port Connector Pinouts.....	38
Table 3-20: RS-422/485 Connector Pinouts.....	38
Table 3-21: SATA Power Connector Pinouts.....	40
Table 3-22: SMBus Connector Pinouts.....	42
Table 3-23: S/PDIF Connector Pinouts.....	43
Table 3-24: SPI Flash Connector Pinouts (SPI1).....	44
Table 3-25: SPI Flash Connector Pinouts (SPI2).....	44
Table 3-26: System Fan Connector Pinouts.....	45
Table 3-27: TPM Connector Pinouts.....	46
Table 3-28: USB Connector Pinouts.....	47
Table 3-29: LAN1_USB2 Connector Pinouts.....	50

Table 3-30: LAN2_USB2 Connector Pinouts	50
Table 3-31: HDMI Connector Pinouts	52
Table 3-32: Serial Port Pinouts.....	53
Table 3-33: VGA Connector Pinouts.....	54
Table 5-1: BIOS Navigation Keys	67

List of BIOS Menus

BIOS Menu 1: Main	68
BIOS Menu 2: Advanced	69
BIOS Menu 3: ACPI Configuration	70
BIOS Menu 4: RTC Wake Settings	71
BIOS Menu 5: Trusted Computing	72
BIOS Menu 6: CPU Configuration	73
BIOS Menu 7: IDE Configuration	74
BIOS Menu 8: USB Configuration	75
BIOS Menu 9: Super IO Configuration.....	76
BIOS Menu 10: Serial Port n Configuration Menu	77
BIOS Menu 11: Hardware Health Configuration	82
BIOS Menu 12: FAN 1 Configuration	83
BIOS Menu 13: Serial Port Console Redirection	85
BIOS Menu 14: Console Redirection Settings.....	86
BIOS Menu 15: Chipset	88
BIOS Menu 16: GFX Configuration	89
BIOS Menu 17: South Bridge Configuration.....	90
BIOS Menu 18: North Bridge Configuration	91
BIOS Menu 19: Boot	92
BIOS Menu 20: Security	94
BIOS Menu 21:Exit.....	95

Chapter

1

Introduction

1.1 Introduction

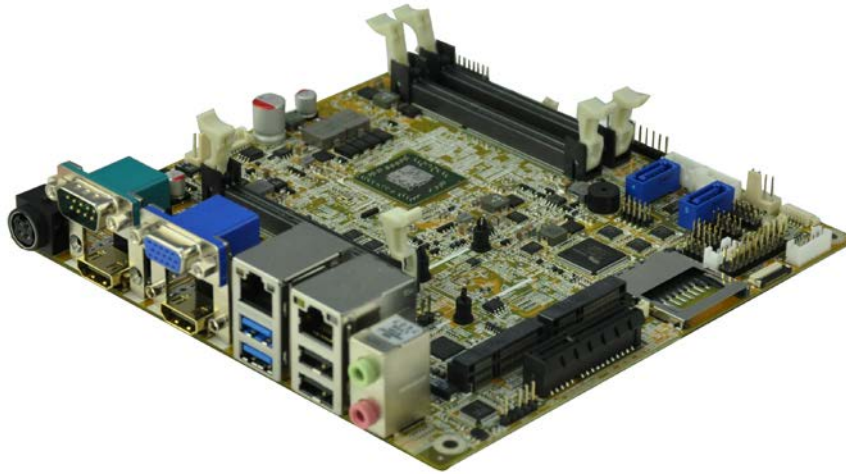

Figure 1-1: KINO-KBN-i2

The KINO-KBN-i2 Mini-ITX motherboard is an AMD® G-Series SoC processor platform. It supports two 1600/1333 MHz DDR3/DDR3L SO-DIMM modules up to 8.0 GB.

The KINO-KBN-i2 includes a VGA connector and two HDMI connectors. Expansion and I/O include two USB 3.0 connectors on the rear panel, two USB 2.0 connectors on the rear panel, two USB 2.0 connectors by pin header and two SATA 6Gb/s connectors. Serial device connectivity is provided by three internal RS-232 connectors, one external RS-232 connector and one internal RS-422/485 connector. Two RJ-45 Ethernet connectors provide the system with smooth connections to an external LAN.

KINO-KBN-i2

1.2 Model Variations

The model variations of the KINO-KBN-i2 Series are listed below.

Model No.	SoC
KINO-KBN-i2-4201	AMD® G-Series GX-420CA, 25W, 2.0GHz
KINO-KBN-i2-2171	AMD® G-Series GX-217GA, 15W, 1.65GHz

Table 1-1: KINO-KBN-i2 Model Variations

1.3 Features

Some of the KINO-KBN-i2 motherboard features are listed below:

- Mini-ITX form factor with AMD® G-Series SoC processor supports DDR3/DDR3L 1600/1333 MHz memory
- 12V only single voltage design for AT/ATX power
- Dual independent display by VGA and dual HDMI
- Support dual PCIe Mini card slot with mSATA, wireless card and DOM capabilities
- IPMI 2.0 support by IPMI-01-R101 module card

1.4 Connectors

The connectors on the KINO-KBN-i2 are shown in the figure below.

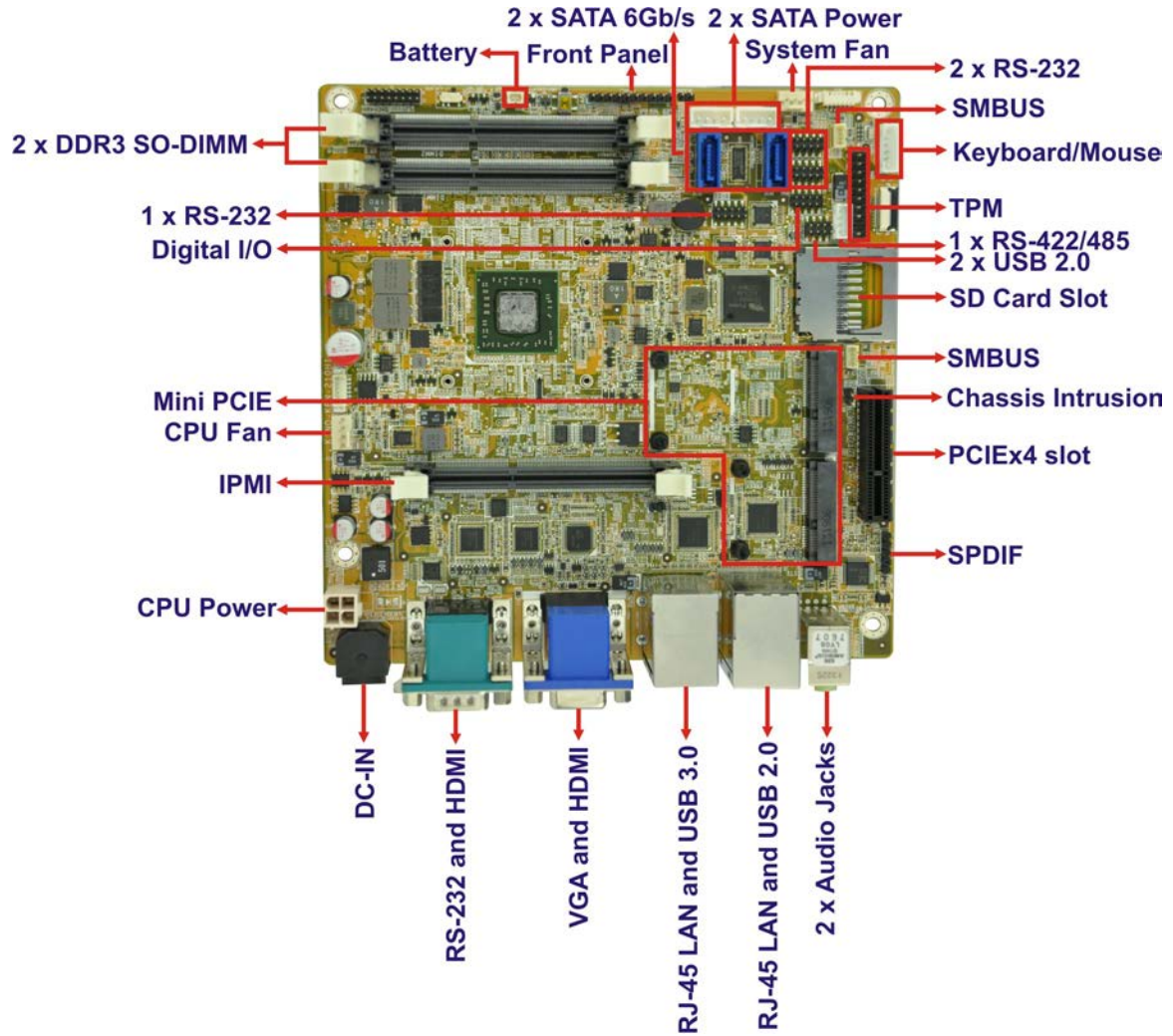

Figure 1-2: Connectors

KINO-KBN-i2

1.5 Dimensions

The dimensions of the board are listed below:

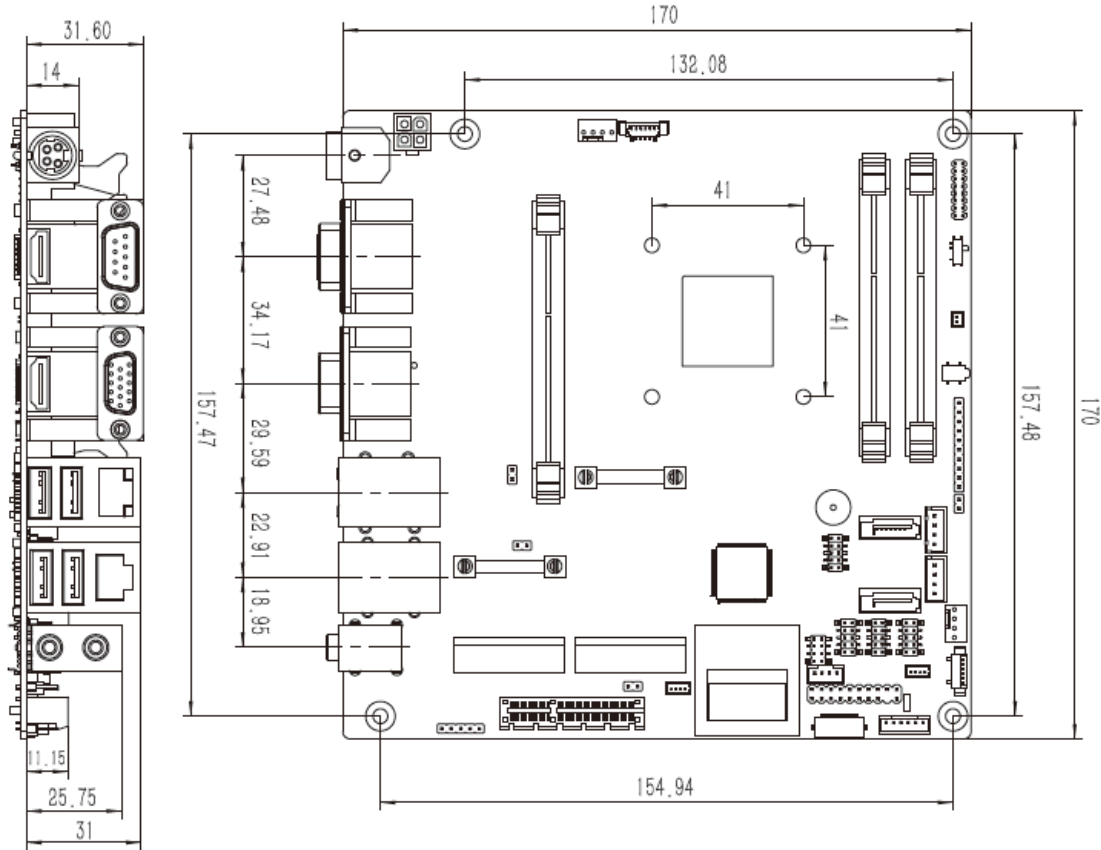

Figure 1-3: Dimensions (mm)

1.6 Data Flow

Figure 1-4 shows the data flow between the system chipset, the CPU and other components installed on the motherboard.

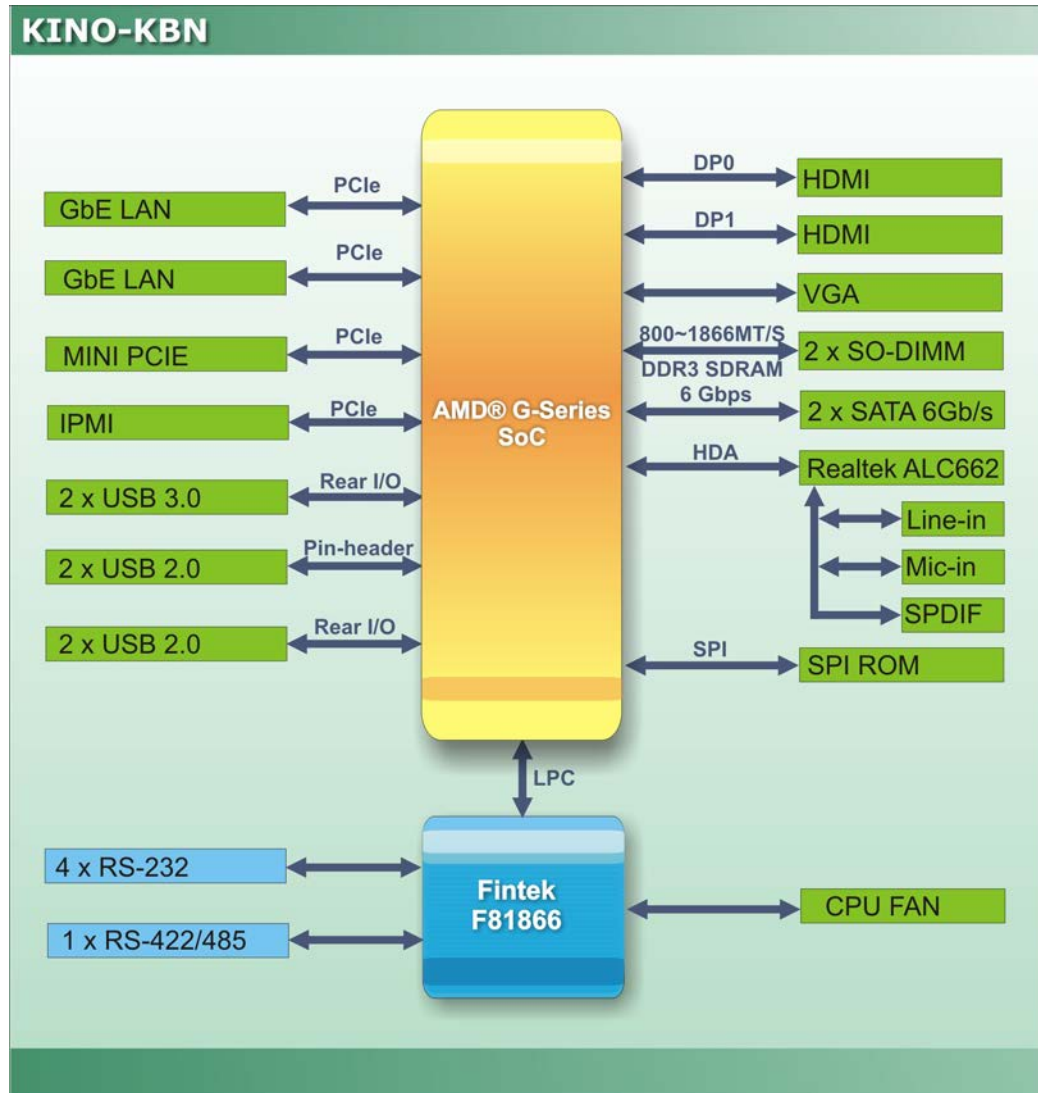

Figure 1-4: Data Flow Diagram

KINO-KBN-i2

1.7 Technical Specifications

KINO-KBN-i2 technical specifications are listed below.

Specification	KINO-KBN-i2
SoC	AMD® G-Series SoC processor
Memory	Two 204-pin 1600/1333 MHz single-channel DDR3/DDR3L SO-DIMM supported (system max. 8 GB)
BIOS	UEFI BIOS
Ethernet	LAN1 (LAN1_USB2): Intel® I210-AT PCIe controller with NCSI support LAN2 (LAN2_USB2): Intel® I211-AT PCIe controller
Graphics	GPU frequency 300MHz (Radeon™ HD 8310E), DirectX® 11.1, UVD4.2, HDMI™ 1.4a, DisplayPort 1.2
Display Output	2 x HDMI (2560x1600) 1 x VGA (2560x1600)
Super IO	Fintek F81866
Audio	Realtek ALC888S HD Audio codec
Watchdog Timer	Software programmable supports 1~255 sec. system reset
I/O Interface Connectors	
Ethernet	Two RJ-45 ports
Audio Connector	1 x S/PDIF for digital audio 2 x Audio jacks on rear IO (line-out, mic-in)
Fan	1 x CPU fan connector (4-pin) 1 x System fan connector (4-pin)
Serial Ports	1 x RS-232 on rear I/O 3 x RS-232 by 8-pin (2x4) header 1 x RS-422/485 by 4-pin (1x4) wafer
USB Ports	2 x USB 3.0 on rear I/O 2 x USB 2.0 on rear I/O 2 x USB 2.0 by 8-pin (2x4) header

Specification	KINO-KBN-i2
Keyboard/Mouse	1 x KB/MS (6-pin wafer)
SD Card	1 x SD card
Front Panel	1 x Front panel (power LED, HDD LED, speaker, power button, reset button)
LAN LED	2 x LAN LED connector (2-pin, 1x2)
SMBus	1 x SMBus connector (4-pin, 1x4)
Digital I/O	8-bit digital I/O (4-bit input / 4-bit output)
IPMI	1 x IPMI slot
Storage	
Serial ATA	2 x SATA 6Gb/s with 5V/12V SATA power connector
Expansion	
Mini PCIe	1 x Full-size PCIe Mini card slot only for mSATA (SATA1 and mSATA shares SATA signal) 1 x Half-size PCIe Mini card slot
PCIe Slot	1 x PCIe x4 slot
Environmental and Power Specifications	
Power Supply	12V DC input only (AT/ ATX support) 1 x Internal power jack (4-pin, 2x2)
Power Consumption	12V@2.7A (AMD GX-424CC 2.4GHz CPU with 1600 MHz 8 GB DDR3 memory)
Operating Temperature	-10°C ~ 60°C
Storage Temperature	-20°C ~ 85°C
Humidity	5% ~ 95% (non-condensing)
Physical Specifications	
Dimensions	170mm x 170mm
Weight GW/NW	600 g / 250 g

Table 1-2: Technical Specifications

Chapter

2

Unpacking

2.1 Anti-static Precautions



WARNING!

Static electricity can destroy certain electronics. Make sure to follow the ESD precautions to prevent damage to the product, and injury to the user.

Make sure to adhere to the following guidelines:

- **Wear an anti-static wristband:** Wearing an anti-static wristband can prevent electrostatic discharge.
- **Self-grounding:** Touch a grounded conductor every few minutes to discharge any excess static buildup.
- **Use an anti-static pad:** When configuring any circuit board, place it on an anti-static mat.
- **Only handle the edges of the PCB:** Don't touch the surface of the motherboard. Hold the motherboard by the edges when handling.

2.2 Unpacking Precautions

When the KINO-KBN-i2 is unpacked, please do the following:

- Follow the antistatic guidelines above.
- Make sure the packing box is facing upwards when opening.
- Make sure all the packing list items are present.

KINO-KBN-i2





2.3 Packing List



NOTE:





If any of the components listed in the checklist below are missing, do not proceed with the installation. Contact the IEI reseller or vendor the KINO-KBN-i2 was purchased from or contact an IEI sales representative directly by sending an email to sales@ieiworld.com.

The KINO-KBN-i2 is shipped with the following components:

Quantity	Item and Part Number	Image
1	KINO-KBN-i2 motherboard	
2	SATA with power output cable kit	
1	I/O shielding	
1	Quick Installation Guide	

2.4 Optional Items

The following are optional components which may be separately purchased:

Item and Part Number	Image
IPMI 2.0 adapter card with AST2400 BMC chip (P/N: iRIS-2400-R10)	 A photograph of a yellow printed circuit board (PCB) IPMI 2.0 adapter card. It features a central black integrated circuit (IC) labeled 'AST2400' and a white label with the 'iRIS' logo and 'IPMI 2.0 Compliant' text. The board has various electronic components and a gold-plated edge connector.
Dual-port USB cable with bracket (P/N: CB-USB02A-RS)	 A photograph of a white dual-port USB cable. It has two USB-A connectors on one end and a metal mounting bracket on the other. The cable is shown in a curved, looped position.
RS-422/485 cable, 200mm (P/N: 32205-003800-300-RS)	 A photograph of a short, white RS-422/485 cable. It has a black plastic connector housing on one end and a flat, white ribbon cable on the other.
RS-232 cable (P/N: 19800-010900-200-RS)	 A photograph of an RS-232 cable. It features a white plastic housing with a blue RS-232C connector on one side and a flat, white ribbon cable on the other.

Chapter

3

Connectors

3.1 Peripheral Interface Connectors

This chapter details all the jumpers and connectors.

3.1.1 KINO-KBN-i2 Layout

The figures below show all the connectors and jumpers.

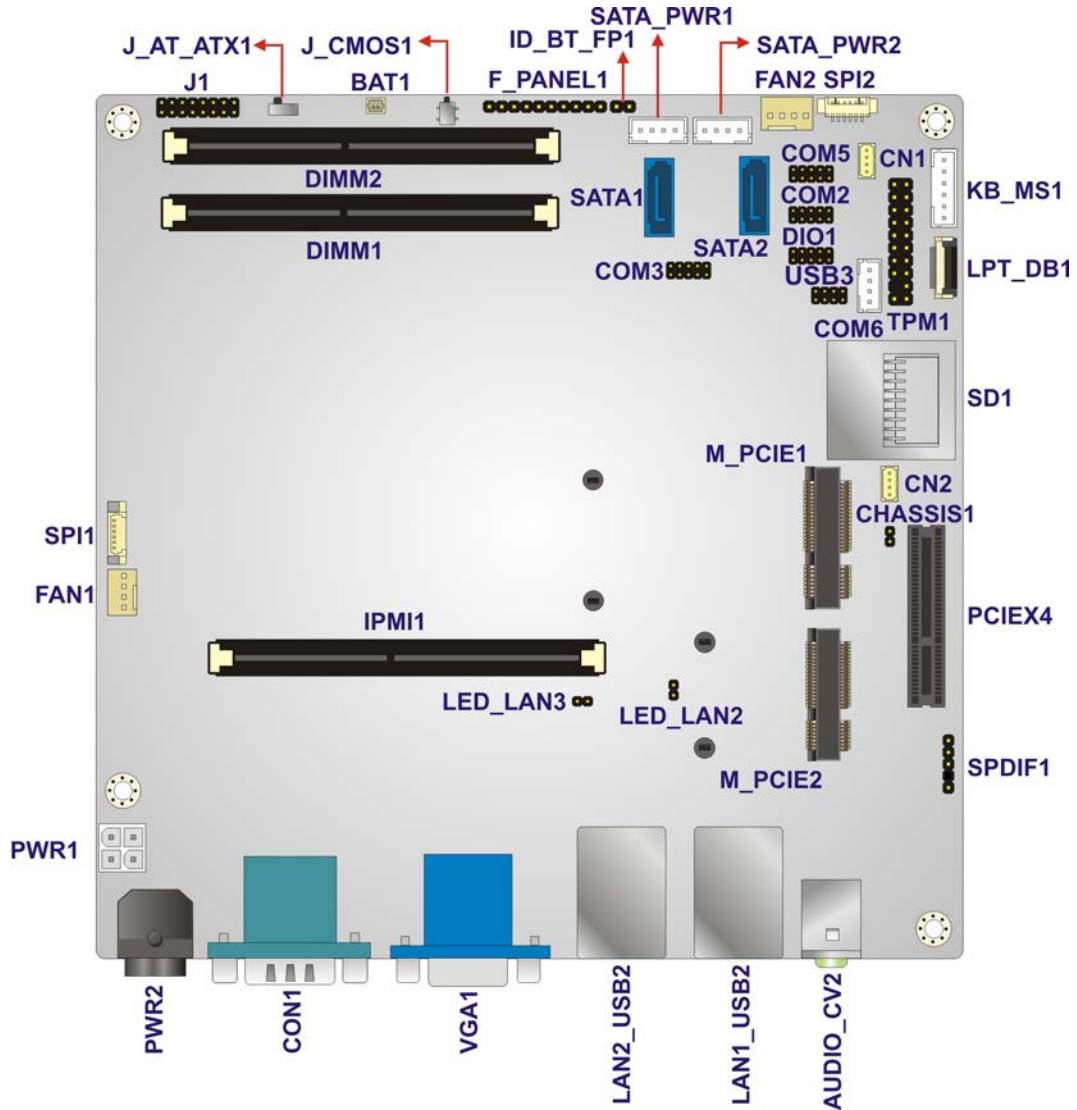

Figure 3-1: Connector and Jumper Locations

KINO-KBN-i2

3.1.2 Peripheral Interface Connectors

The table below lists all the connectors on the board.

Connector	Type	Label
AT/ATX mode select switch	switch	J_ATX_AT1
Battery connector	2-pin wafer	BAT1
Chassis intrusion connector	2-pin header	CHASSIS1
Clear CMOS button	button	J_CMOS1
CPU fan connector	4-pin wafer	FAN1
CPU power connector	4-pin Molex	PWR1
DDR3/DDR3L SO-DIMM slots	DDR3/DDR3L SO-DIMM slot	DIMM1, DIMM2
Digital I/O connector	10-pin header	DIO1
EC debug connector	20-pin FPC connector	LPT_DB1
Front panel connector	10-pin wafer	F_PANEL1
IPMI LED connector	2-pin header	ID_BT_FP1
IPMI slot	204-pin slot	IPMI1
Keyboard and mouse connector	6-pin wafer	KB_MS1
LAN LED connectors	2-pin header	LED_LAN2, LED_LAN3
PCIe x4 slot	PCIe x4 slot	PCIEX4
PCIe Mini Card Slots	PCIe mini card slot	M_PCIE1, M_PCIE2
RS-232 serial port connector	10-pin header	COM2, COM3, COM5
RS-422/485 serial port connector	4-pin wafer	COM6
SATA 6Gb/s drive connectors	7-pin SATA connector	SATA1, SATA2
SATA power connectors	2-pin wafer	SATA_PWR1, SATA_PWR2

SD card slot	SD card slot	SD1
SMBus connectors	4-pin wafer	CN1, CN2
S/PDIF connector	5-pin header	SPDIF1
SPI Flash connectors	6-pin wafer	SPI1, SPI2
System fan connector	4-pin wafer	FAN2
TPM connector	20-pin connector	TPM1
USB connector	8-pin header	USB3

Table 3-1: Peripheral Interface Connectors

3.1.3 External Interface Panel Connectors

The table below lists the connectors on the external I/O panel.

Connector	Type	Label
Audio jacks	Audio jack	AUDIO_CV2
Ethernet and USB 2.0 ports	RJ-45, USB 2.0	LAN1_USB2
Ethernet and USB 3.0 ports	RJ-45, USB 3.0	LAN2_USB2
Power connector	DC power jack	PWR2
Serial port and HDMI connectors	DB-9, HDMI	COM1,HDMI1
VGA and HDMI connectors	15-pin female, HDMI	VGA1,HDMI2

Table 3-2: Rear Panel Connectors

KINO-KBN-i2

3.2 Internal Peripheral Connectors

The section describes all of the connectors on the KINO-KBN-i2.

3.2.1 AT/ATX Mode Select Switch

- CN Label:** J_ATX_AT1
- CN Type:** switch
- CN Location:** See **Figure 3-2**
- CN Settings:** See **Table 3-3**

The AT/ATX mode select switch specifies the systems power mode as AT or ATX. AT/ATX mode select switch settings are shown in **Table 3-3**.

Setting	Description	
Short 1-2	AT Mode	
Short 2-3	ATX Mode	Default

Table 3-3: AT/ATX Mode Select Switch Settings

The location of the AT/ATX mode select switch is shown in **Figure 3-2** below.

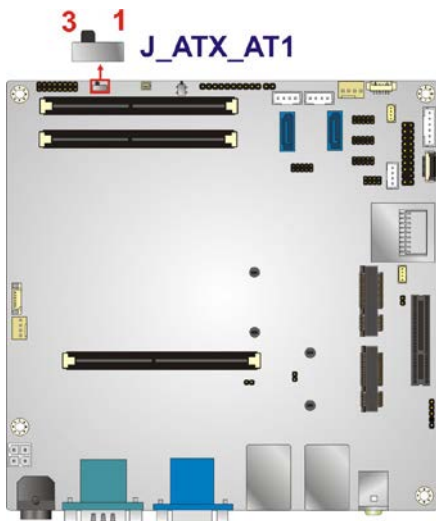

Figure 3-2: AT/ATX Mode Select Switch Location

3.2.2 Battery Connector



CAUTION:

Risk of explosion if battery is replaced by an incorrect type. Only certified engineers should replace the on-board battery.

Dispose of used batteries according to instructions and local regulations.

CN Label:	BAT1
CN Type:	2-pin wafer
CN Location:	See Figure 3-3
CN Pinouts:	See Table 3-4

The battery connector is connected to the system battery. The battery provides power to the system clock to retain the time when power is turned off. **NOTE:** It is recommended to attach the RTC battery onto the system chassis in which the KINO-KBN-i2 is installed.

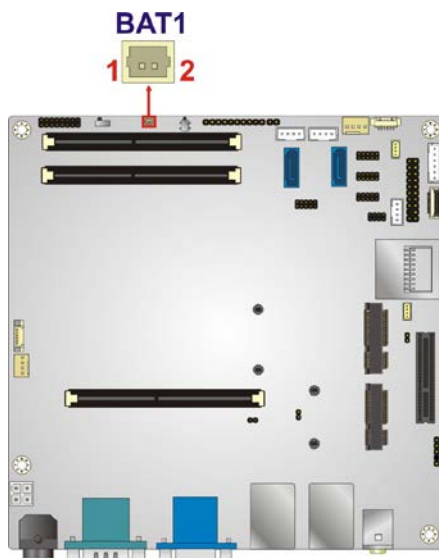

Figure 3-3: Battery Connector Location

KINO-KBN-i2

PIN NO.	DESCRIPTION	PIN NO.	DESCRIPTION
1	+VBAT	2	GND

Table 3-4: Battery Connector Pinouts

3.2.3 Chassis Intrusion Connector

- CN Label:** CHASSIS1
- CN Type:** 2-pin header
- CN Location:** See **Figure 3-4**
- CN Pinouts:** See **Table 3-5**

The chassis intrusion connector is for a chassis intrusion detection sensor or switch that detects if a chassis component is removed or replaced.

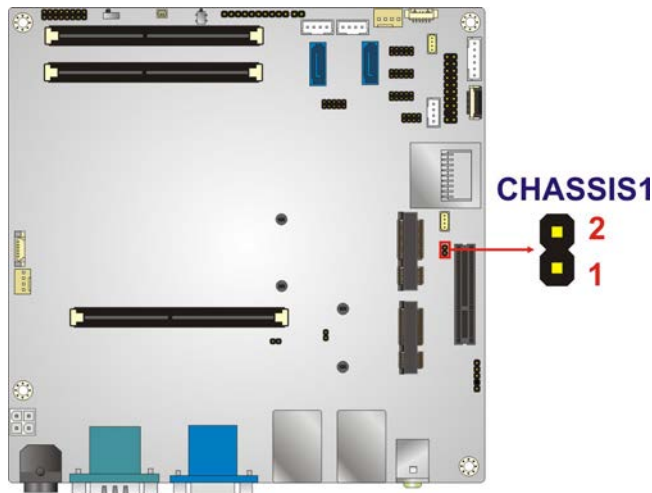

Figure 3-4: Chassis Intrusion Connector Location

Pin	Description
1	+V3.3A_EC_PLL
2	CHASSIE_EC

Table 3-5: Chassis Intrusion Connector Pinouts

3.2.4 Clear CMOS Button

- CN Label:** J_CMOS1
- CN Type:** button
- CN Location:** See **Figure 3-5**
- CN Settings:** See **Table 3-6**

If the KINO-KBN-i2 fails to boot due to improper BIOS settings, use the button to clear the CMOS data and reset the system BIOS information.

The clear CMOS button settings are shown in **Table 3-6**.

Setting	Description	
Open	Normal Operation	Default
Push	Clear CMOS Setup	

Table 3-6: Clear CMOS Button Settings

The location of the clear CMOS button is shown in **Figure 3-5**.

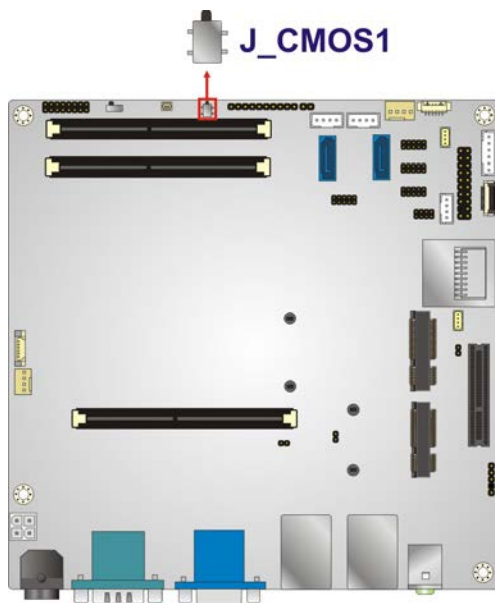

Figure 3-5: Clear CMOS Button Location

KINO-KBN-i2

3.2.5 CPU Fan Connector

- CN Label:** FAN1
- CN Type:** 4-pin wafer
- CN Location:** See **Figure 3-6**
- CN Pinouts:** See **Table 3-7**

The fan connector attaches to a CPU cooling fan.

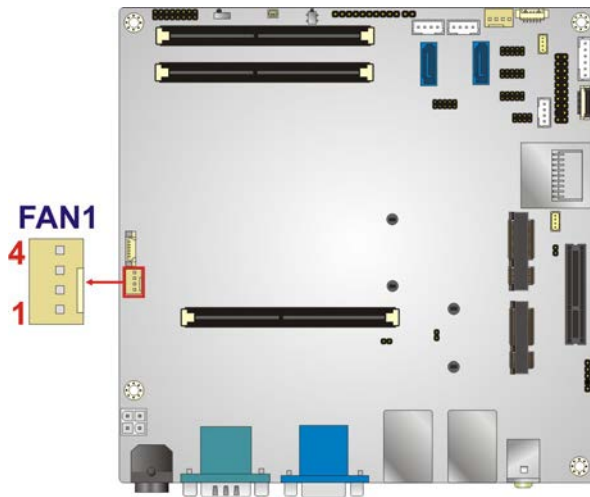

Figure 3-6: CPU Fan Connector Locations

PIN NO.	DESCRIPTION	PIN NO.	DESCRIPTION
1	GND	2	+12V
3	FAN1IN	4	FAN1OUT

Table 3-7: CPU Fan Connector Pinouts

3.2.6 CPU Power Connector

- CN Label:** PWR1
- CN Type:** 4-pin Molex
- CN Location:** See **Figure 3-7**
- CN Pinouts:** See **Table 3-8**

The CPU power connector provides power to the CPU.

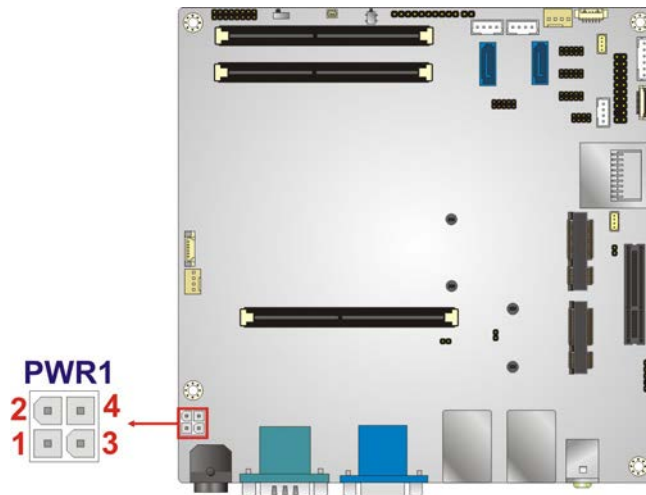

Figure 3-7: CPU Power Connector Location

PIN NO.	DESCRIPTION	PIN NO.	DESCRIPTION
1	GND_VIN	2	GND_VIN
3	12VIN_1	4	12VIN_1

Table 3-8: CPU Power Connector Pinouts

KINO-KBN-i2

3.2.7 DDR3/DDR3L SO-DIMM Slots

- CN Label:** DIMM1, DIMM2
- CN Type:** DDR3/DDR3L SO-DIMM slot
- CN Location:** See **Figure 3-8**

The DDR3/DDR3L SO-DIMM slot is for DDR3/DDR3L SO-DIMM memory module. DIMM2 slot must be installed memory module.

**CAUTION:**

For dual channel configuration, always install two identical memory modules that feature the same capacity, timings, voltage, number of ranks and the same brand.

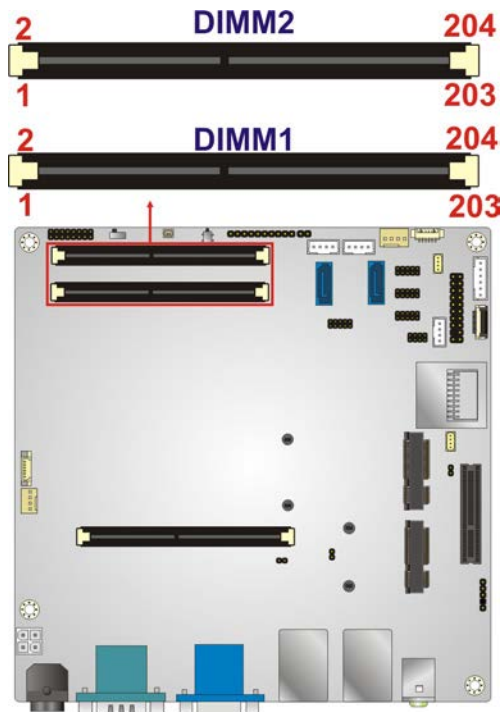

Figure 3-8: DDR3/DDR3L SO-DIMM Slot Location

3.2.8 Digital I/O Connector

- CN Label:** DIO1
- CN Type:** 10-pin header
- CN Location:** See **Figure 3-9**
- CN Pinouts:** See **Table 3-9**

The digital I/O connector provides programmable input and output for external devices. The digital I/O provides 4-bit output and 4-bit input.

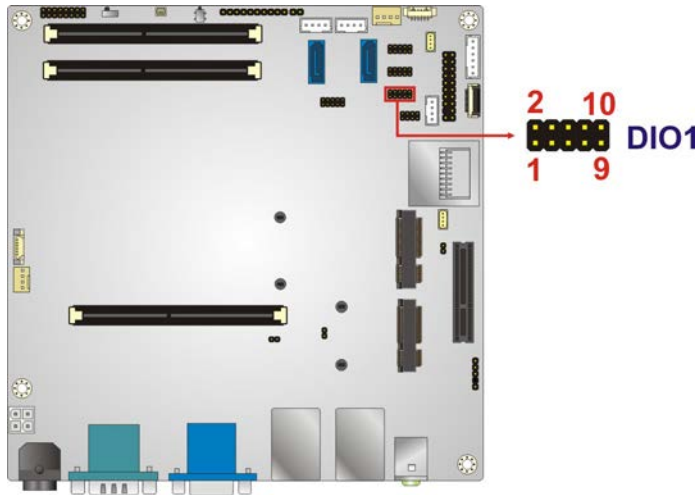

Figure 3-9: Digital I/O Connector Location

PIN NO.	DESCRIPTION	PIN NO.	DESCRIPTION
1	GND	2	+5V
3	DOUT3	4	DOUT2
5	DOUT1	6	DOUT0
7	DIN3	8	DIN2
9	DIN1	10	DIN0

Table 3-9: Digital I/O Connector Pinouts

KINO-KBN-i2

3.2.9 EC Debug Connector

- CN Label:** LPT_DB1
- CN Type:** 20-pin FPC connector
- CN Location:** See **Figure 3-10**
- CN Pinouts:** See **Table 3-10**

The EC debug connector connects to a debug card for Embedded Controller (EC) debug.

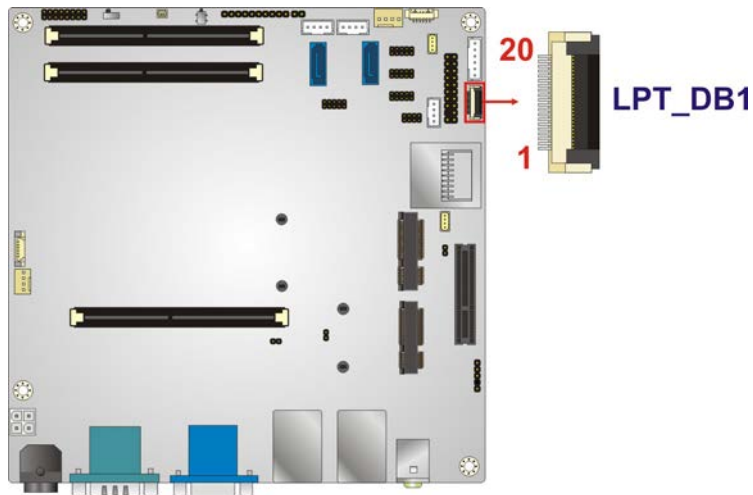

Figure 3-10: EC Debug Connector Location

Pin	Description	Pin	Description
1	KSI0	11	KSO9
2	KSO0	12	KSO10
3	KSO1	13	KSO12
4	KSO2	14	KSI1
5	KSO3	15	KSO11
6	KSO4	16	KSI2
7	KSO5	17	KSI3
8	KSO6	18	GND
9	KSO7	19	GND
10	KSO8	20	GND

Table 3-10: EC Debug Connector Pinouts

3.2.10 Front Panel Connector

- CN Label:** F_PANEL1
- CN Type:** 10-pin header
- CN Location:** See **Figure 3-11**
- CN Pinouts:** See **Table 3-11**

The front panel connector connects to the indicator LEDs on the system front panel.

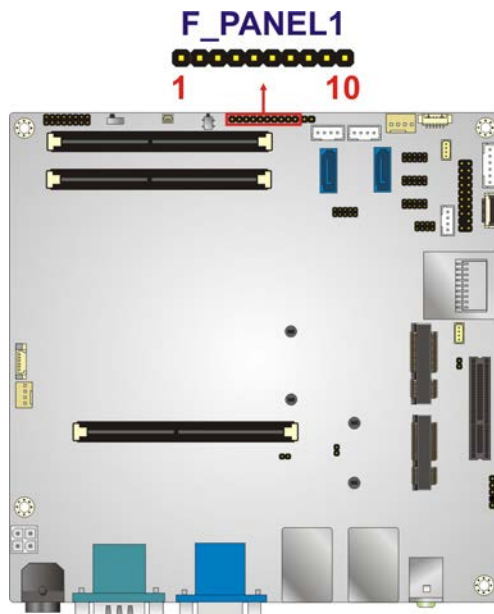

Figure 3-11: Front Panel Connector Location

PIN NO.	DESCRIPTION	PIN NO.	DESCRIPTION
1	NC	2	PWRBTN+
3	GND	4	HDD LED+
5	HDD LED-	6	PWR LED+
7	PWR LED+	8	PWR LED-
9	RST BTN+	10	GND

Table 3-11: Front Panel Connector Pinouts

KINO-KBN-i2

3.2.11 IPMI LED Connector

- CN Label:** ID_BT_FP1
- CN Type:** 2-pin header
- CN Location:** See **Figure 3-12**
- CN Pinouts:** See **Table 3-12**

The IPMI LED connector is used to connect to the IPMI LED indicator on the chassis.

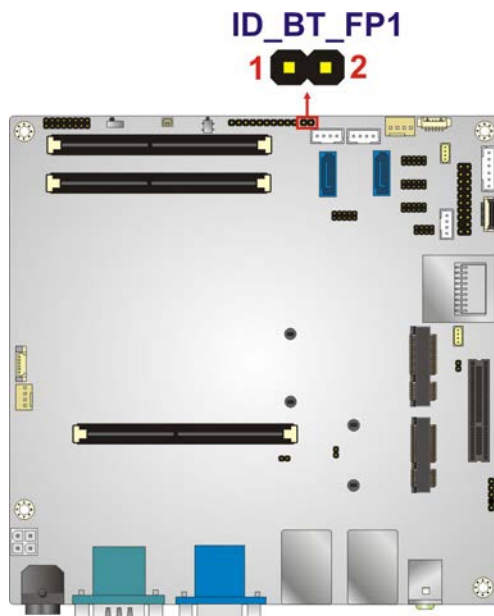

Figure 3-12: IPMI LED Connector Location

Pin	Description
1	+V3.3A_EC_PLL
2	ID_BT_FP#

Table 3-12: IPMI LED Connector Pinouts

3.2.12 IPMI Slot

- CN Label:** IPMI1
- CN Type:** IPMI slot
- CN Location:** See **Figure 3-13**
- CN Pinouts:** See **Table 3-13**

The IPMI slot is for IPMI module card.

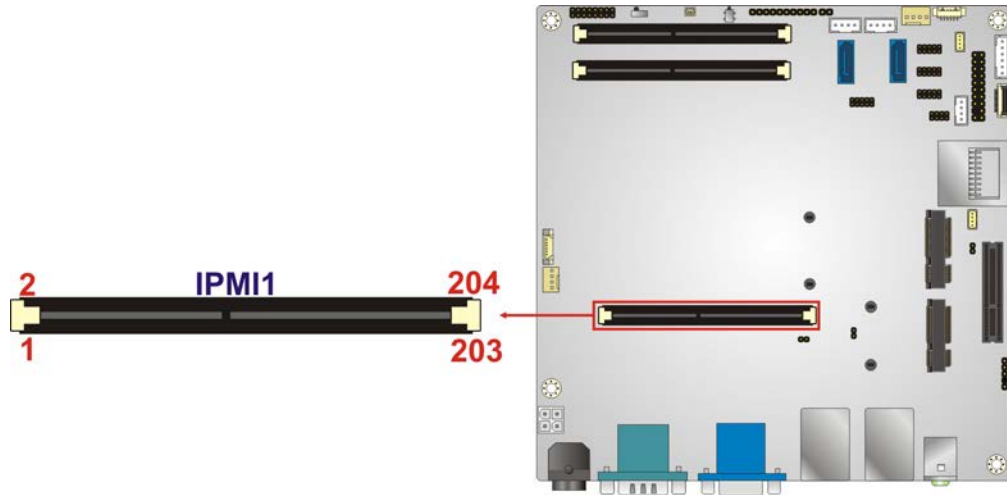

Figure 3-13: IPMI Slot Location

PIN	DESCRIPTION	PIN	DESCRIPTION	PIN	DESCRIPTION	PIN	DESCRIPTION
1	VGA_G2	52	NC	103	NC_SI_RXD1	154	PMBUS_ALERT#
2	NC	53	SDATA1_LAN1	104	NC_SI_TXD1	155	GND
3	VGA_R2	54	GND	105	+5V_DUAL	156	GND
4	NC	55	GND	106	+5V_DUAL	157	NC
5	VGA_B2	56	DATA5_P	107	NC	158	NC
6	NC	57	DATA4_P	108	NC_SI_CRS_DV	159	NC
7	NC	58	DATA5_N	109	NC_SI_CLK_IN	160	NC
8	NC	59	DATA4_N	110	NC_SI_TX_EN	161	GND
9	VSYNC2	60	GND	111	+5V_DUAL	162	GND
10	NC	61	GND	112	+5V_DUAL	163	RTS#4
11	HSYNC2	62	APU_PROCHOT# _IPMI	113	APU_VDD_RUN	164	RXD4

KINO-KBN-i2

12	NC	63	GND	114	NC	165	DTR#4
13	VI_DDCDAT	64	+3.3V	115	+0.95V_ALW	166	TXD4
14	NC	65	GND	116	APU_VDDIO_SUS	167	GND
15	VI_DDCCLK	66	GND	117	+5V	168	GND
16	NC	67	NC	118	+5V	169	-CASEOPEN
17	NC	68	NC	119	NC	170	GND
18	NC	69	NC	120	APU_VTT_SUS	171	SYS_RST#
19	GND	70	NC	121	NC	172	GND
20	GND	71	GND	122	SPI_SWITCH	173	GND
21	SMB_PCIE_3V3_CLK	72	GND	123	+3.3V	174	BMC_TXD5
22	SMB_IPMB_3VSB_CLK	73	APU_VDD_RUN	124	+3.3V	175	DSR#4
23	SMB_PCIE_3V3_DATA	74	NC	125	ID_BT_FP#	176	BMC_RXD5
24	SMB_IPMB_3VSB_DATA	75	+3.3V_DUAL	126	NC	177	CTS#4
25	GND	76	+3.3V_DUAL	127	GND	178	GND
26	GND	77	NC	128	IPMI_DET#	179	GND
27	BMC_SPKR	78	AMBER_LED-_B MC	129	SPI_BMC_BIOS_CS O_N	180	LAD2
28	GND	79	NC	130	SPI_PATBRG_R_CS O_N	181	LAD0
29	APU_VDD_PWRGD_IPMI	80	GREEN_LED-_B MC	131	SPI_BMC_BIOS_CL K	182	LAD3
30	NC	81	+3.3V_DUAL	132	SPI_PATBRG_R_CL K	183	LAD1
31	GND	82	+3.3V_DUAL	133	GND	184	GND
32	GND	83	NC	134	GND	185	GND
33	SMB_TEMP_3VSB_CLK	84	ID_LED#_BMC	135	SMI_ACTIVE#	186	PWRBTSW#
34	NC	85	PCIE_RST#	136	GND	187	GND

35	SMB_TEMP_3VSB_DATA	86	PCIE_WAKE_UP#	137	NMI_EVENT#	188	PWRBTSW_BMC
36	NC	87	+3.3V_DUAL	138	GND	189	GND
37	GND	88	+3.3V_DUAL	139	GND	190	GND
38	GND	89	NC	140	SPI_PATBRG_RSIS	191	NC
39	SCLK1_BMC	90	GPP_CLK3N	141	SPI_BMC_BIOS_MOSI	192	LFRAME#
40	ACLK_LAN2	91	NC	142	SPI_PATBRG_MISO	193	LPC_CLKO_IPMI
41	SDATA1_BMC	92	GPP_CLK3P	143	SPI_BMC_BIOS_MISO	194	SERIRQ
42	SDATA1_LAN2	93	+3.3V_DUAL	144	GND	195	GND
43	GND	94	+3.3V_DUAL	145	GND	196	GND
44	GND	95	IPMI_RXN	146	NC	197	PM_RSMRST#_SIO
45	SYS_PWRGD_IPMI	96	IPMI_TXN	147	NC	198	PME#
46	GND	97	IPMI_RXP	148	NC	199	NC
47	SYS_PWRGD_IPMI	98	IPMI_TXP	149	NC	200	SLP_S3#
48	GND	99	+5V_DUAL	150	GND	201	SLP_S4#
49	GND	100	+5V_DUAL	151	GND	202	SLP_S5#
50	NC	101	NC_SI_RXD0	152	PBG_SYS_RESET_N_BMC	203	BMC_PSON
51	ACLK_LAN1	102	NC_SI_TXD0	153	GND	204	PS_ON#

Table 3-13: IPMI Slot Pinouts

KINO-KBN-i2

3.2.13 Keyboard/Mouse Connector

- CN Label:** KB_MS1
- CN Type:** 6-pin wafer
- CN Location:** See **Figure 3-14**
- CN Pinouts:** See **Table 3-14**

The keyboard/mouse connector connects to a PS/2 Y-cable that can be connected to a PS/2 keyboard and mouse.

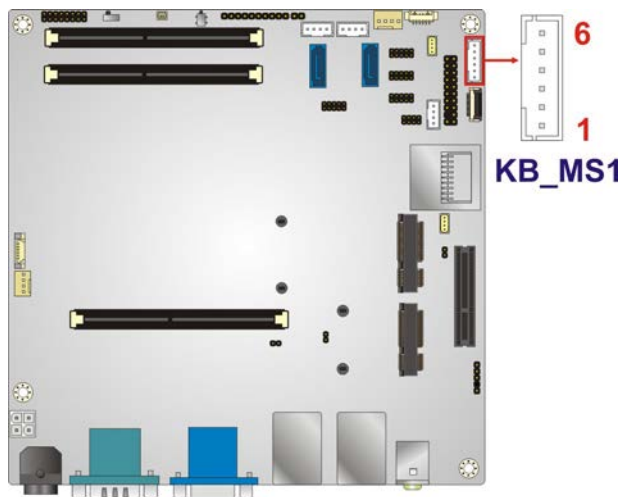

Figure 3-14: Keyboard/Mouse Connector Location

Pin	Description
1	VCC5_KBMS
2	MSDATA
3	MSCLK
4	KBDATA
5	KBCLK
6	KBMS_GND

Table 3-14: Keyboard/Mouse Connector Pinouts

3.2.14 LAN LED Connector

- CN Label:** LED_LAN2, LED_LAN3
- CN Type:** 2-pin header
- CN Location:** See **Figure 3-15**
- CN Pinouts:** See **Table 3-15**

The LAN LED connectors connect to the LAN link LEDs on the system.

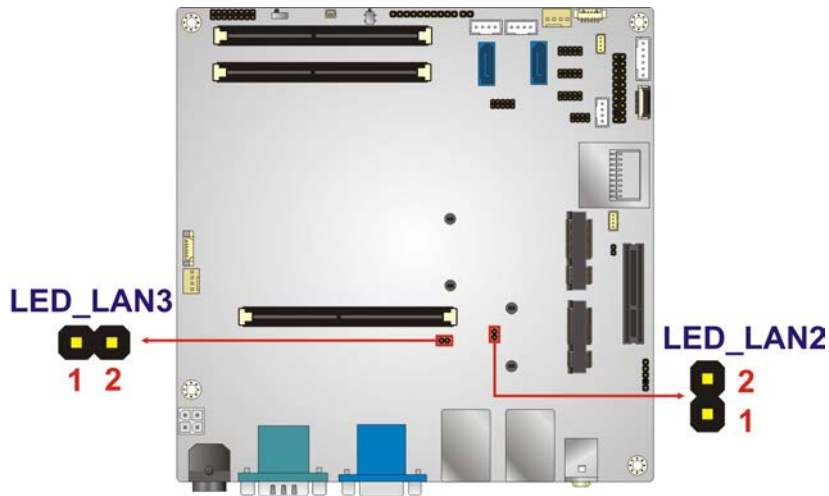

Figure 3-15: LAN LED Connector Location

PIN NO.	DESCRIPTION	PIN NO.	DESCRIPTION
1	PWR	2	L1/2_LINK_ACT-

Table 3-15: LAN LED Connector Pinouts

3.2.15 PCIe x4 Slot

- CN Label:** PCIEX4
- CN Type:** PCIe x4 slot
- CN Location:** See **Figure 3-16**
- CN Pinouts:** See **Table 3-16**

The PCIe x4 slot is for PCIe x4 expansion cards.

KINO-KBN-i2

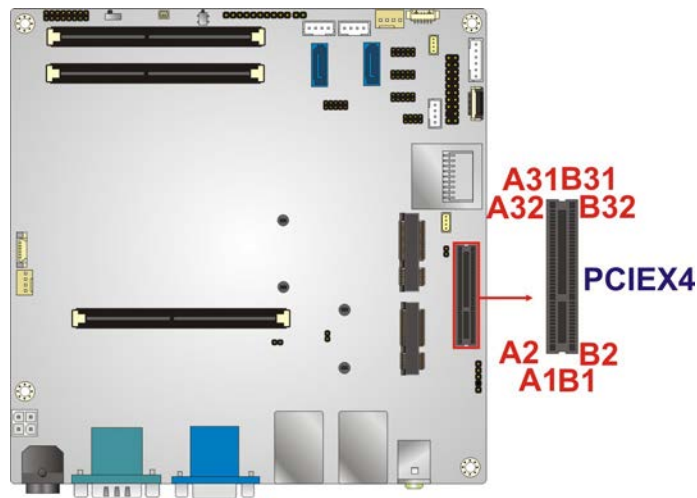

Figure 3-16: PCIe x4 Slot Location

PIN NO.	DESCRIPTION	PIN NO.	DESCRIPTION
A1	NC	B1	+12V
A2	+12V	B2	+12V
A3	+12V	B3	+12V
A4	GND	B4	GND
A5	NC	B5	SCLK1
A6	NC	B6	SDATA1
A7	NC	B7	GND
A8	NC	B8	+3.3V
A9	+3.3V	B9	NC
A10	+3.3V	B10	+3.3V_DUAL
A11	PCIE_RST#	B11	PCIE_WAKE_UP#
A12	GND	B12	NC
A13	GFX_CLKOP	B13	GND
A14	GFX_CLKON	B14	P_GFX_TXPO
A15	GND	B15	P_GFX_TXNO
A16	P_GFX_RXPO	B16	GND
A17	P_GFX_RXNO	B17	NC
A18	GND	B18	GND
A19	NC	B19	P_GFX_TXP1
A20	GND	B20	P_GFX_TXN1

A21	P_GFX_RXP1	B21	GND
A22	P_GFX_RXN1	B22	GND
A23	GND	B23	P_GFX_TXP2
A24	GND	B24	P_GFX_TXN2
A25	P_GFX_RXP2	B25	GND
A26	P_GFX_RXN2	B26	GND
A27	GND	B27	P_GFX_TXP3
A28	GND	B28	P_GFX_TXN3
A29	P_GFX_RXP3	B29	GND
A30	P_GFX_RXN3	B30	NC
A31	GND	B31	NC
A32	NC	B32	GND

Table 3-16: PCIe x4 Slot Pinouts

3.2.16 PCIe Mini Card Slot

CN Label: M_PCIE1, M_PCIE2

CN Type: full-size PCIe mini card slot, half-size PCIe mini card slot

CN Location: See **Figure 3-17**

CN Pinouts: See **Table 3-17** and **Table 3-18**

The half-size PCIe mini card slot enables a PCIe mini card expansion module to be connected to the board. The full-size PCIe mini card slot is for installing mSATA cards.

KINO-KBN-i2

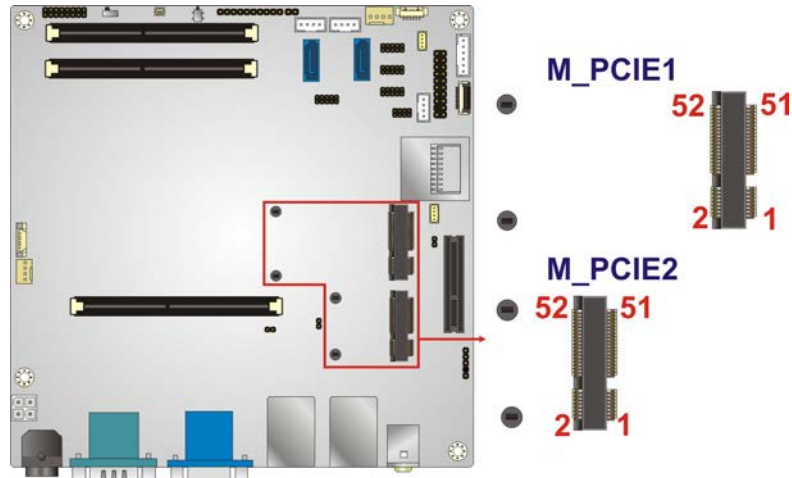

Figure 3-17: PCIe Mini Card Slot Location

PIN NO.	DESCRIPTION	PIN NO.	DESCRIPTION
1	NC	27	GND
2	VCC3_MINI_1	28	+V1.5_MINI_1
3	NC	29	GND
4	GND	30	SCLK1
5	NC	31	MPCIE_TXDN
6	+V1.5_MINI_1	32	SDATA1
7	NC	33	MPCIE_TXDP
8	NC	34	GND
9	GND	35	GND
10	NC	36	USB6N
11	GPP_CLK2N	37	GND
12	NC	38	USB6P
13	GPP_CLK2P	39	VCC3_MINI_1
14	NC	40	GND
15	GND	41	VCC3_MINI_1
16	NC	42	NC
17	PCIE_RST#	43	NC
18	GND	44	NC
19	NC	45	NC
20	N48174558	46	NC

PIN NO.	DESCRIPTION	PIN NO.	DESCRIPTION
21	GND	47	NC
22	PCIE_RST#	48	+V1.5_MINI_1
23	MPCIE_RXDN	49	NC
24	+3.3V_DUAL	50	GND
25	MPCIE_RXDP	51	mSATA_DET#
26	GND	52	VCC3_MINI_1

Table 3-17: PCIe Mini Card Slot Pinouts (M_PCIE1)

PIN NO.	DESCRIPTION	PIN NO.	DESCRIPTION
1	NC	27	GND
2	VCC3_MINI_2	28	+V1.5_MINI_2
3	NC	29	GND
4	GND	30	SCLK1
5	NC	31	MINISLOT1_TXDN
6	+V1.5_MINI_2	32	SDATA1
7	MINI_PCIE_SLT1_CLKREQ#	33	MINISLOT1_TXDP
8	NC	34	GND
9	GND	35	GND
10	NC	36	USB7N
11	NC	37	GND
12	NC	38	USB7P
13	NC	39	VCC3_MINI_2
14	NC	40	GND
15	GND	41	VCC3_MINI_2
16	NC	42	NC
17	PCIE_RST#	43	NC
18	GND	44	NC
19	NC	45	NC
20	WL_DISABLE1#	46	NC
21	GND	47	NC
22	PCIE_RST#	48	+V1.5_MINI_2

KINO-KBN-i2

PIN NO.	DESCRIPTION	PIN NO.	DESCRIPTION
23	MINISLOT1_RXDN	49	NC
24	+3.3V_DUAL	50	GND
25	MINISLOT1_RXDP	51	NC
26	GND	52	VCC3_MINI_2

Table 3-18: PCIe Mini Card Slot Pinouts (M_PCIE2)

3.2.17 RS-232 Serial Port Connector

CN Label: COM2, COM3, COM5

CN Type: 10-pin header

CN Location: See Figure 3-18

CN Pinouts: See Table 3-19

The serial connector provides RS-232 connection.

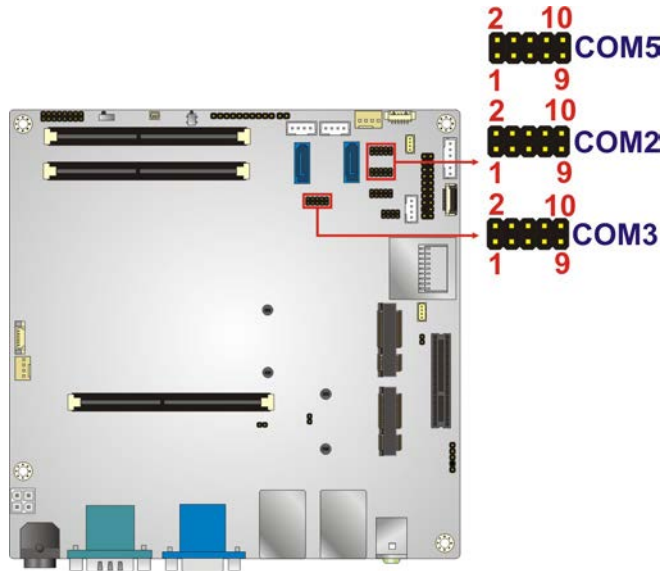

Figure 3-18: RS-232 Serial Port Connector Location

PIN NO.	DESCRIPTION	PIN NO.	DESCRIPTION
1	NDCD2/3/5	2	NDSR2/3/5
3	NRX2/3/5	4	NRTS2/3/5
5	NTX2/3/5	6	NCTS2/3/5

PIN NO.	DESCRIPTION	PIN NO.	DESCRIPTION
7	NDTR2/3/5	8	NR12/3/5
9	GND	10	GND

Table 3-19: RS-232 Serial Port Connector Pinouts

3.2.18 RS-422/485 Serial Port Connector

- CN Label:** COM6
- CN Type:** 4-pin wafer
- CN Location:** See Figure 3-19
- CN Pinouts:** See Table 3-20

This connector provides RS-422 or RS-485 communications.

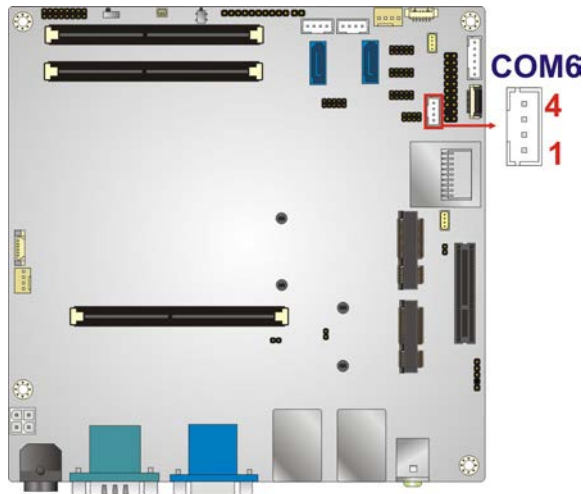

Figure 3-19: RS-422/485 Connector Location

PIN NO.	DESCRIPTION	PIN NO.	DESCRIPTION
1	RXD485#	2	RXD485+
3	TXD485+	4	TXD485#

Table 3-20: RS-422/485 Connector Pinouts

KINO-KBN-i2**3.2.19 SATA 6Gb/s Drive Connector**

CN Label:	SATA1, SATA2
CN Type:	7-pin SATA connector
CN Location:	See Figure 3-20

The SATA 6Gb/s drive connector is connected to a SATA 6Gb/s drive. The SATA 6Gb/s drive transfers data at speeds as high as 6Gb/s.

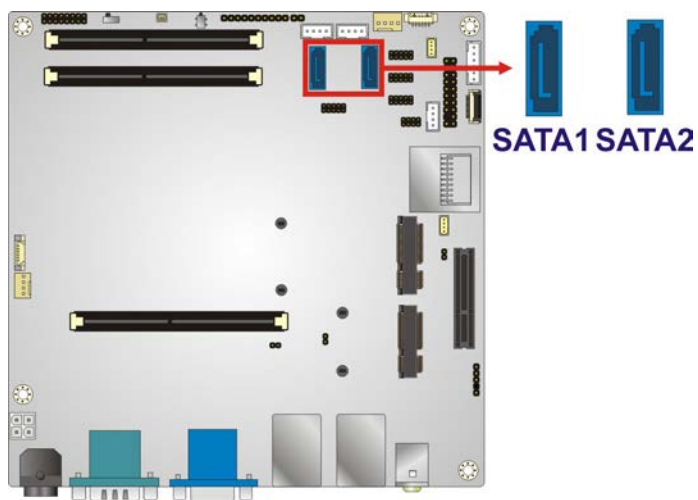

Figure 3-20: SATA 6Gb/s Drive Connector Location

3.2.20 SATA Power Connector

CN Label: SATA_PWR1, SATA_PWR2

CN Type: 4-pin wafer

CN Location: See Figure 3-21

CN Pinouts: See Table 3-21

The SATA power connector provides +5V power output to the SATA connector.

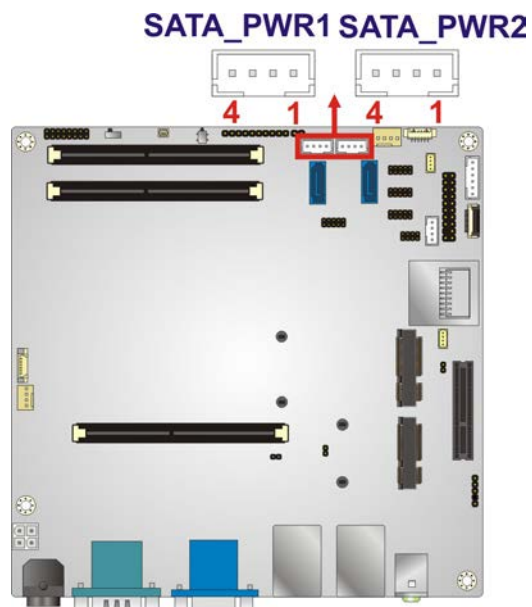

Figure 3-21: SATA Power Connector Location

PIN NO.	DESCRIPTION
1	+12V
2	GND
3	GND
4	+5V

Table 3-21: SATA Power Connector Pinouts

KINO-KBN-i2

3.2.21 SD Card Slot

- CN Label:** SD1
- CN Type:** SD card slot
- CN Location:** See **Figure 3-22**

An SD memory card can be inserted to the SD card slot on the KINO-KBN-i2.

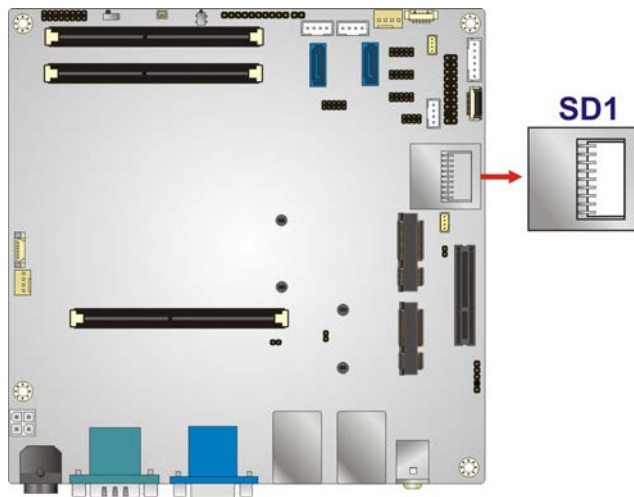

Figure 3-22: SD Card Slot Location

3.2.22 SMBUS Connector

- CN Label:** CN1, CN2
- CN Type:** 4-pin wafer
- CN Location:** See **Figure 3-23**
- CN Pinouts:** See **Table 3-22**

The SMBus (System Management Bus) connector provides low-speed system management communications.

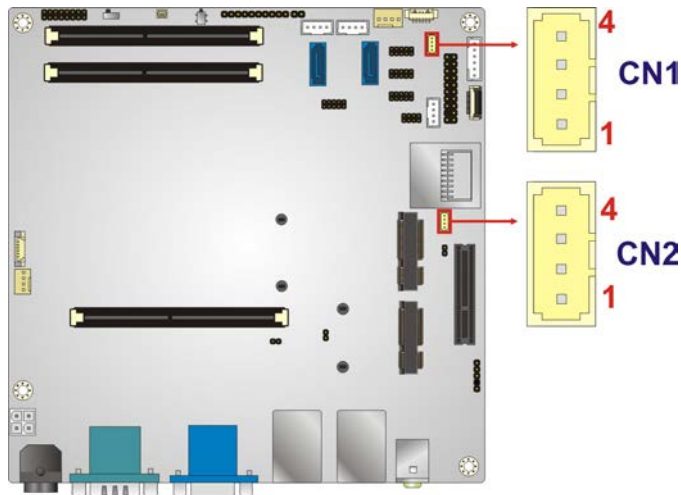

Figure 3-23: SMBus Connector Location

PIN NO.	DESCRIPTION	PIN NO.	DESCRIPTION
1	GND	2	SDATA0/1
3	SCLK0/1	4	+5V

Table 3-22: SMBus Connector Pinouts

KINO-KBN-i2

3.2.23 S/PDIF Connector

- CN Label:** SPDIF1
- CN Type:** 5-pin header
- CN Location:** See **Figure 3-24**
- CN Pinouts:** See **Table 3-23**

Use the S/PDIF connector to connect digital audio devices to the system.

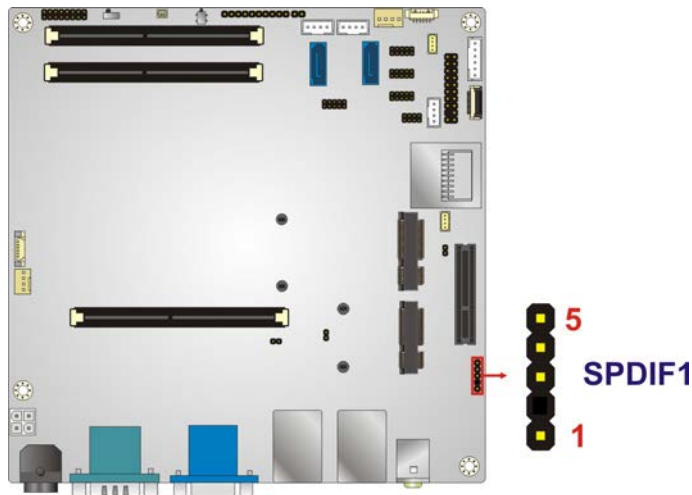

Figure 3-24: S/PDIF Connector Location

Pin	Description
1	+5V
2	NC
3	SPDIF OUT
4	GND
5	SPDIF IN

Table 3-23: S/PDIF Connector Pinouts

3.2.24 SPI Flash Connector

- CN Label:** SPI1, SPI2
- CN Type:** 6-pin wafer
- CN Location:** See **Figure 3-25**
- CN Pinouts:** See **Table 3-24** and **Table 3-25**

The SPI Flash connector is used to flash the BIOS.

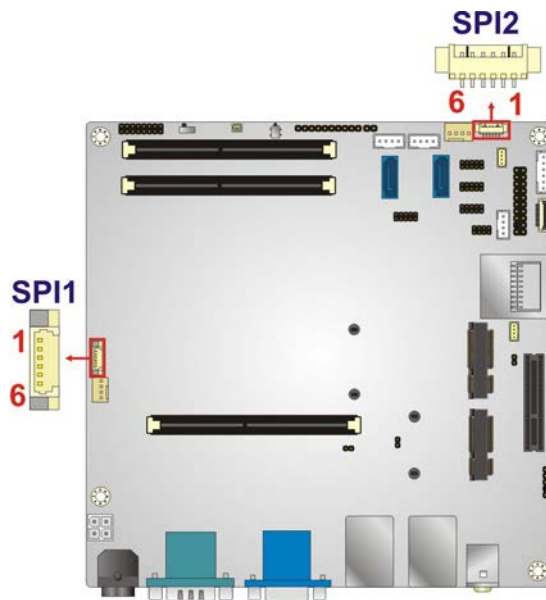

Figure 3-25: SPI Flash Connector Location

PIN NO.	DESCRIPTION	PIN NO.	DESCRIPTION
1	SPI_POWER	2	SPI_CS#_CONN
3	SPI_DATAIN_CONN	4	SPI_CLK_CONN
5	SPI_DATAOUT_CONN	6	GND

Table 3-24: SPI Flash Connector Pinouts (SPI1)

PIN NO.	DESCRIPTION	PIN NO.	DESCRIPTION
1	EC_SPI_VCC	2	FSCE#
3	FMISO	4	FSCK
5	FMOSI	6	GND

Table 3-25: SPI Flash Connector Pinouts (SPI2)

KINO-KBN-i2

3.2.25 System Fan Connector

- CN Label:** FAN2
- CN Type:** 4-pin wafer
- CN Location:** See **Figure 3-26**
- CN Pinouts:** See **Table 3-26**

The fan connector attaches to a system cooling fan.

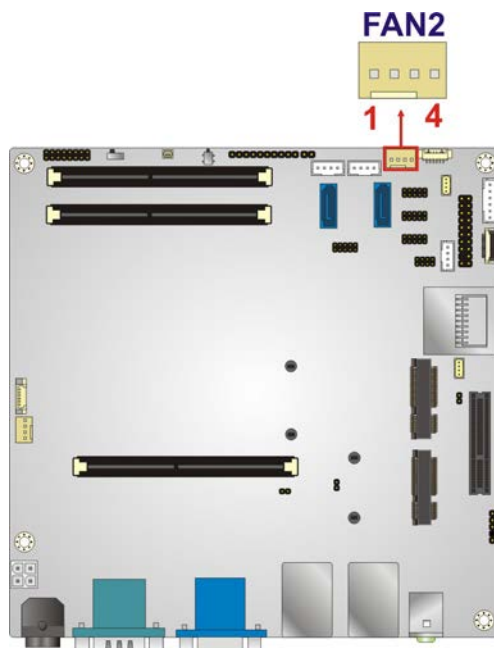

Figure 3-26: System Fan Connector Locations

PIN NO.	DESCRIPTION	PIN NO.	DESCRIPTION
1	GND	2	+12V
3	FAN2IN	4	FAN2OUT

Table 3-26: System Fan Connector Pinouts

3.2.26 TPM Connector

- CN Label:** TPM1
- CN Type:** 20-pin connector
- CN Location:** See **Figure 3-27**
- CN Pinouts:** See **Table 3-27**

The Trusted Platform Module (TPM) connector secures the system on bootup.

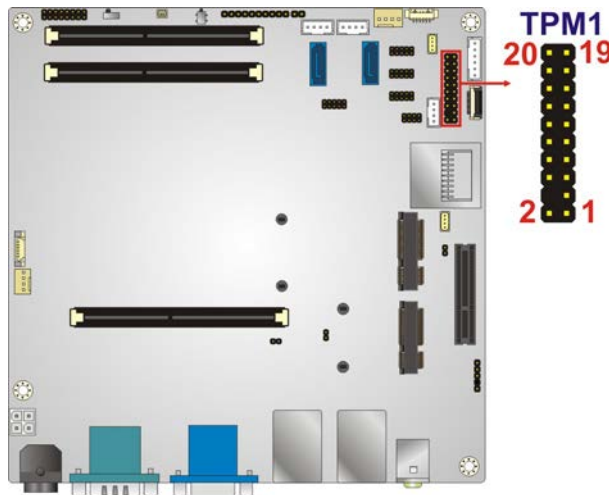

Figure 3-27: TPM Connector Location

PIN NO.	DESCRIPTION	PIN NO.	DESCRIPTION
1	LPC_CLK1	2	GND
3	LFRAME#	4	NC
5	LPC_RST#	6	+5V
7	LAD3	8	LAD2
9	+ 3.3V	10	LAD1
11	LAD0	12	GND
13	SCLK0	14	SDATA0
15	+3.3V_DUAL	16	SERIRQ
17	GND	18	LPC_CLKRUN#
19	LPCPD#	20	LDRQ#0

Table 3-27: TPM Connector Pinouts

KINO-KBN-i2

3.2.27 USB Connector

- CN Label:** USB3
- CN Type:** 8-pin header
- CN Location:** See **Figure 3-28**
- CN Pinouts:** See **Table 3-28**

The USB connector provides two USB 2.0 ports by dual-port USB cable.

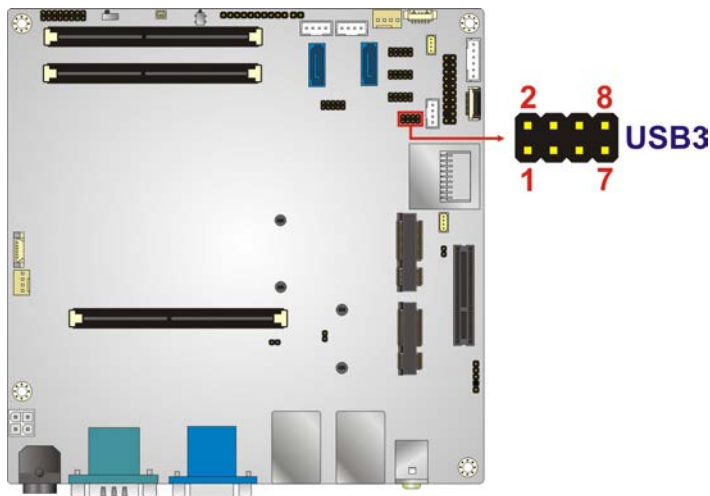

Figure 3-28: USB Connector Locations

PIN NO.	DESCRIPTION	PIN NO.	DESCRIPTION
1	USBV2L	2	GND
3	DATA2_N	4	DATA3_P
5	DATA2_P	6	DATA3_N
7	GND	8	USBV2L

Table 3-28: USB Connector Pinouts

3.3 External Peripheral Interface Connector Panel

Figure 3-29 shows the KINO-KBN-i2 external peripheral interface connector (EPIC) panel. The EPIC panel consists of the following:

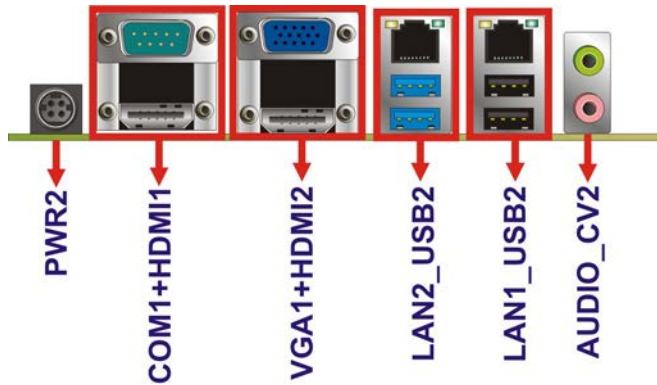

Figure 3-29: External Peripheral Interface Connector

3.3.1 Audio Connector

CN Label: AUDIO_CV2

CN Type: Audio jacks

CN Location: See Figure 3-29

The audio jacks connect to external audio devices.

- **Line Out port (Lime):** Connects to a headphone or a speaker. With multi-channel configurations, this port can also connect to front speakers.
- **Microphone (Pink):** Connects a microphone.



Figure 3-30: Audio Connector

KINO-KBN-i2

3.3.2 Ethernet and USB Connectors

- CN Label:** LAN1_USB2, LAN2_USB2
- CN Type:** RJ-45 , USB 2.0 and USB 3.0 ports
- CN Location:** See **Figure 3-29**
- CN Pinouts:** See **Figure 3-31** , **Table 3-29** and **Table 3-30**

The LAN connector connects to a local network. LAN1 supports IPMI 2.0 through the optional iRIS-2400 module.

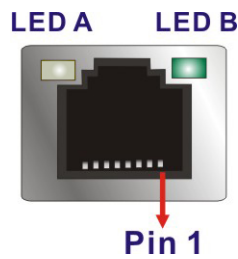

Figure 3-31: LAN Connector

The USB 2.0 ports are for attaching USB 2.0 peripheral devices to the system. The pinouts of LAN1 and USB 2.0 connectors are shown below.

PIN NO.	DESCRIPTION	PIN NO.	DESCRIPTION
1	USBVOL	16	NC
2	DATA0_N	P1	1.5VLAN1
3	DATA0_P	P2	TRD1P0
4	GND	P3	TRD1N0
5	USBVOL	P4	TRD1P1
6	DATA1_N	P5	TRD1N1
7	DATA1_P	P6	TRD1P2
8	GND	P7	TRD1N2
9	NC	P8	TRD1P3
10	NC	P9	TRD1N3
11	NC	P10	GND
12	NC	P11	L1_100-

13	NC	P12	L1_1000-
14	NC	P13	L1_LINK_ACT-
15	NC	P14	+V3.3LAN1

Table 3-29: LAN1_USB2 Connector Pinouts

The USB 3.0 ports are for attaching USB 3.0 peripheral devices to the system. To be able to use the USB 3.0 ports, please make sure the USB 3.0 driver is installed. The pinouts of LAN2 and USB 3.0 connectors are shown below.

PIN NO.	DESCRIPTION	PIN NO.	DESCRIPTION
G1	IO_GND_1	R8	TRD2P3
G2	IO_GND_1	R9	TRD2N3
G3	IO_GND_1	U1	USB_3P0_VCC1
G4	IO_GND_1	U2	USB2P8_DMO_L
G5	IO_GND_1	U3	USB2P8_DPO_L
G6	IO_GND_1	U4	GND
G7	IO_GND_1	U5	USB3P0_RXDN0_C
G8	IO_GND_1	U6	USB3P0_RXDPO_C
L1	L2_100-	U7	GND
L2	L2_1000-	U8	USB3P0_TXDN0_C
L3	L2_LINK_ACT-	U9	USB3P0_TXDPO_C
L4	+V3.3LAN2	U10	USB_3P0_VCC2
R1	1.5VLAN2	U11	USB2P9_DM1_L
R10	GND	U12	USB2P9_DP1_L
R2	TRD2P0	U13	GND
R3	TRD2N0	U14	USB3P0_RXDN1_C
R4	TRD2P1	U15	USB3P0_RXDP1_C
R5	TRD2N1	U16	GND
R6	TRD2P2	U17	USB3P0_TXDN1_C
R7	TRD2N2	U18	USB3P0_TXDP1_C

Table 3-30: LAN2_USB2 Connector Pinouts

**NOTE:**

During Windows 7 OS installation, the USB 3.0 functionality will be disabled until the USB 3.0 drivers are installed. In order to use USB 3.0 ports for OS installation, the following steps must be followed:

1. Copy the USB 3.0 drivers to a USB flash drive.
2. When “**A Required CD/DVD Device Driver is Missing**” error dialog appears during OS installation, press **F6**.
3. The “**Browse for Folder**” window prompts user to select the folder that contains USB 3.0 drivers. After selecting the folder, select and install drivers for **AMD USB 3.0 Host Controller (amdxhc.inf)** and **AMD USB 3.0 Hub (amdhub30.inf)** in order.

3.3.3 HDMI Connector

CN Label:	HDMI1, HDMI2
CN Type:	HDMI connector
CN Location:	See Figure 3-29
CN Pinouts:	See Table 3-31

The HDMI connector connects to a display device with HDMI interface.

Pin	Description	Pin	Description
1	HDMI_DATA2	13	N/C
2	GND	14	N/C
3	HDMI_DATA2#	15	HDMI_SCL
4	HDMI_DATA1	16	HDMI_SDA
5	GND	17	GND
6	HDMI_DATA1#	18	+5V
7	HDMI_DATA0	19	HDMI_HPD
8	GND	20	HDMI_GND

Pin	Description	Pin	Description
9	HDMI_DATA0#	21	HDMI_GND
10	HDMI_CLK	22	HDMI_GND
11	GND	23	HDMI_GND
12	HDMI_CLK#		

Table 3-31: HDMI Connector Pinouts

3.3.4 Power Connector

- CN Label:** PWR2
- CN Type:** 4-pin DIN
- CN Location:** See **Figure 3-29**

The power connector supports 12V DC power input.

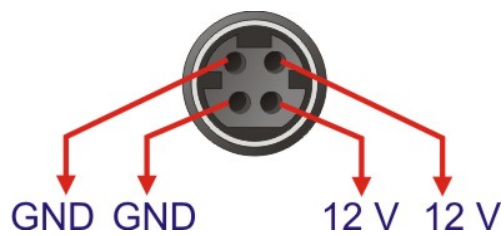

Figure 3-32: Power Connector (4-pin DIN)

KINO-KBN-i2

3.3.5 Serial Port Connector (COM1)

- CN Label:** COM1
- CN Type:** DB-9 Male connector
- CN Location:** See **Figure 3-29**
- CN Pinouts:** See **Table 3-32** and **Figure 3-33**

The RS-232 serial connector provides serial connection in the RS-232 mode.

Pin	Description	Pin	Description
1	NDCD1	6	NDSR1
2	NRX1	7	NRTS1
3	NTX1	8	NCTS1
4	NDTR1	9	NRI1
5	GND		

Table 3-32: Serial Port Pinouts

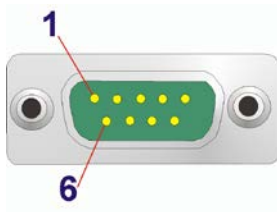

Figure 3-33: Serial Port Pinout Locations

3.3.6 VGA Connector

- CN Label:** VGA1
- CN Type:** D-sub 15-pin female connector
- CN Location:** See **Figure 3-29**
- CN Pinouts:** See **Figure 3-34** an **Table 3-33**

The standard 15-pin female VGA connector connects to a CRT or LCD monitor.

Pin	Description	Pin	Description	Pin	Description
1	RED	6	GND	11	NC
2	GREEN	7	GND	12	5VDDCDA
3	BLUE	8	GND	13	VGA_HSYNC
4	NC	9	CRT_VCC	14	VGA_VSYNC
5	GND	10	GND	15	5VDDCLK

Table 3-33: VGA Connector Pinouts

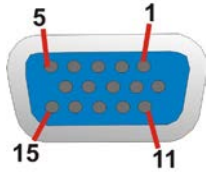

Figure 3-34: VGA Connector

Chapter

4

Installation

4.1 Anti-static Precautions



WARNING:

Failure to take ESD precautions during the installation of the KINO-KBN-i2 may result in permanent damage to the KINO-KBN-i2 and severe injury to the user.

Electrostatic discharge (ESD) can cause serious damage to electronic components, including the KINO-KBN-i2. Dry climates are especially susceptible to ESD. It is therefore critical that whenever the KINO-KBN-i2 or any other electrical component is handled, the following anti-static precautions are strictly adhered to.

- **Wear an anti-static wristband:** Wearing a simple anti-static wristband can help to prevent ESD from damaging the board.
- **Self-grounding:** Before handling the board, touch any grounded conducting material. During the time the board is handled, frequently touch any conducting materials that are connected to the ground.
- **Use an anti-static pad:** When configuring the KINO-KBN-i2, place it on an anti-static pad. This reduces the possibility of ESD damaging the KINO-KBN-i2.
- **Only handle the edges of the PCB:** When handling the PCB, hold the PCB by the edges.

4.2 Installation Considerations



NOTE:

The following installation notices and installation considerations should be read and understood before installation. All installation notices must be strictly adhered to. Failing to adhere to these precautions may lead to severe damage and injury to the person performing the installation.

KINO-KBN-i2



WARNING:

The installation instructions described in this manual should be carefully followed in order to prevent damage to the KINO-KBN-i2, KINO-KBN-i2 components and injury to the user.

Before and during the installation please **DO** the following:

- Read the user manual:
 - The user manual provides a complete description of the KINO-KBN-i2 installation instructions and configuration options.
- Wear an electrostatic discharge cuff (ESD):
 - Electronic components are easily damaged by ESD. Wearing an ESD cuff removes ESD from the body and helps prevent ESD damage.
- Place the KINO-KBN-i2 on an antistatic pad:
 - When installing or configuring the motherboard, place it on an antistatic pad. This helps to prevent potential ESD damage.
- Turn all power to the KINO-KBN-i2 off:
 - When working with the KINO-KBN-i2, make sure that it is disconnected from all power supplies and that no electricity is being fed into the system.

Before and during the installation of the KINO-KBN-i2 **DO NOT:**

- Remove any of the stickers on the PCB board. These stickers are required for warranty validation.
- Use the product before verifying all the cables and power connectors are properly connected.
- Allow screws to come in contact with the PCB circuit, connector pins, or its components.

4.2.1 SO-DIMM Installation

To install a SO-DIMM, please follow the steps below and refer to **Figure 4-1**.



CAUTION:

For dual channel configuration, always install two identical memory modules that feature the same capacity, timings, voltage, number of ranks and the same brand.

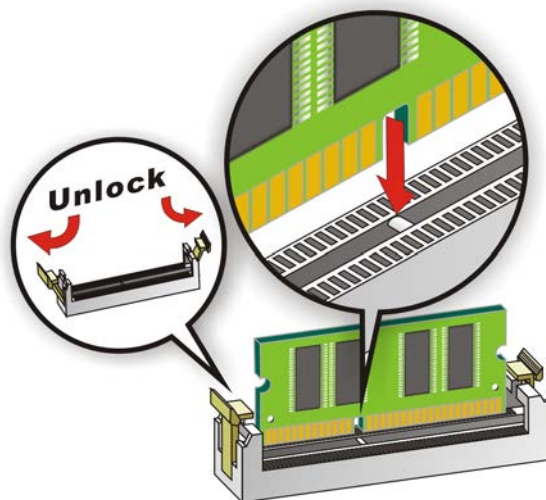

Figure 4-1: SO-DIMM Installation

- Step 1: Open the SO-DIMM socket handles.** Open the two handles outwards as far as they can. See **Figure 4-1**.
- Step 2: Align the SO-DIMM with the socket.** Align the DIMM so the notch on the memory lines up with the notch on the memory socket. See **Figure 4-1**.
- Step 3: Insert the SO-DIMM.** Once aligned, press down until the SO-DIMM is properly seated. Clip the two handles into place. See **Figure 4-1**.
- Step 4: Removing a SO-DIMM.** To remove a SO-DIMM, push both handles outward. The memory module is ejected by a mechanism in the socket.

KINO-KBN-i2

4.2.2 IPMI Module Installation (Optional)

**WARNING:**

The IPMI module slot is designed to install the IEI iRIS-2400 IPMI 2.0 module only. DO NOT install other modules into the IPMI module slot. Doing so may cause damage to the KINO-KBN-i2.

To install the iRIS-2400 module, please follow the steps below and refer to Figure 4-2.

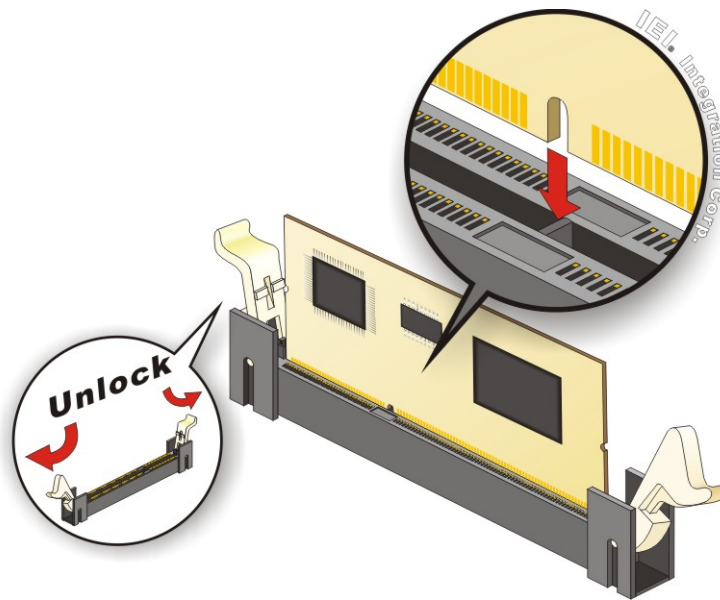

Figure 4-2: IPMI Module Installation

- Step 1: Open the socket handles.** Open the two handles outwards as far as they can. See Figure 4-2.
- Step 2: Align the iRIS-2400 module with the socket.** Align the iRIS-2400 module so the notch on the module lines up with the notch on the socket. See Figure 4-2.
- Step 3: Insert the iRIS-2400 module.** Once aligned, press down until the iRIS-2400 module is properly seated. Clip the two handles into place. See Figure 4-2.

Step 4: **Removing the iRIS-2400 module.** To remove the iRIS-2400 module, push both handles outward. The module is ejected by a mechanism in the socket.

4.3 Internal Peripheral Device Connections

This section outlines the installation of peripheral devices to the on-board connectors

4.3.1 SATA Drive Connection

The KINO-KBN-i2 is shipped with two SATA drive cable. To connect the SATA drive to the connector, please follow the steps below.

Step 1: Locate the SATA connector and the SATA power connector. The locations of the connectors are shown in Chapter 3.

Step 2: **Insert the cable connector.** Insert the cable connector into the on-board SATA drive connector and the SATA power connector. See **Figure 4-3**.

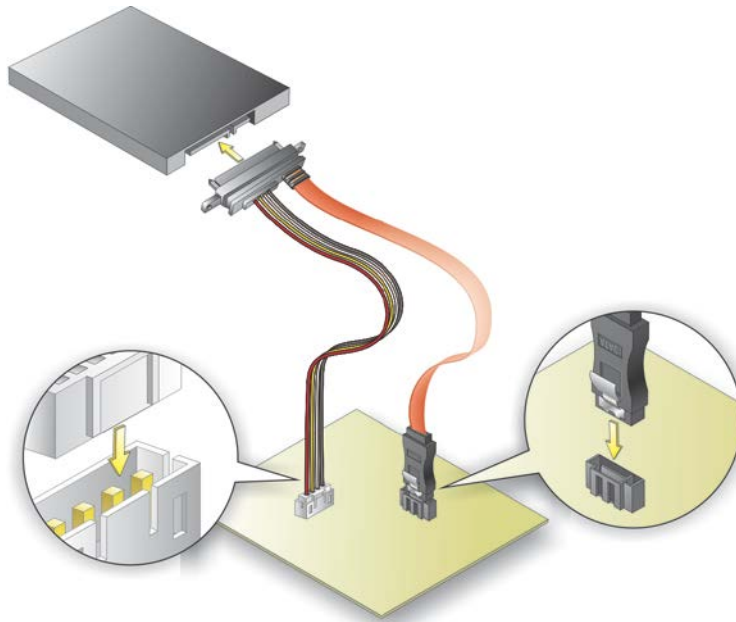

Figure 4-3: SATA Drive Cable Connection

Step 3: **Connect the cable to the SATA disk.** Connect the connector on the other end of the cable to the connector at the back of the SATA drive. See Figure 4-3.

KINO-KBN-i2

Step 4: To remove the SATA cable from the SATA connector, press the clip on the connector at the end of the cable.

4.3.2 Single RS-232 Cable

The single RS-232 cable consists of one serial port connector attached to a serial communications cable that is then attached to a D-sub 9 male connector. To install the single RS-232 cable, please follow the steps below.

Step 1: Locate the connector. The location of the RS-232 connector is shown in Chapter 3.

Step 2: Insert the cable connector. Insert the connector into the serial port box header. See Figure 4-4. A key on the front of the cable connectors ensures the connector can only be installed in one direction.

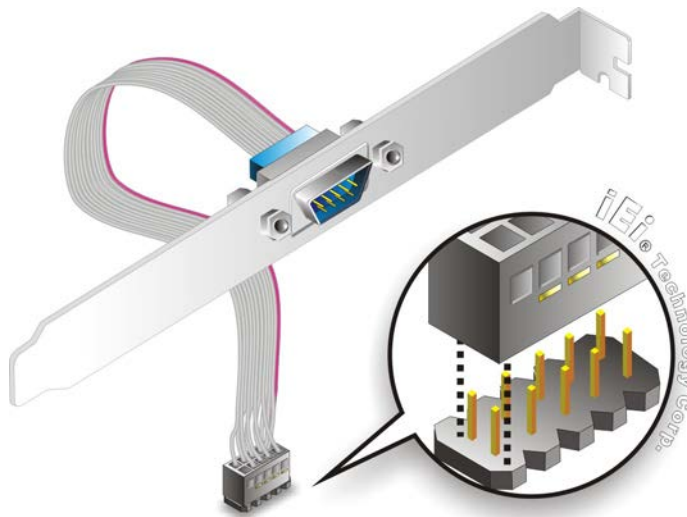

Figure 4-4: Single RS-232 Cable Installation

Step 3: Secure the bracket. The single RS-232 connector has two retention screws that must be secured to a chassis or bracket.

Step 4: Connect the serial device. Once the single RS-232 connector is connected to a chassis or bracket, a serial communications device can be connected to the system.

4.4 IPMI Setup Procedure

The KINO-KBN-i2 features Intelligent Platform Management Interface (IPMI) that helps lower the overall costs of server management by enabling users to maximize IT resources, save time and manage multiple systems. The KINO-KBN-i2 supports IPMI 2.0 through the optional iRIS-2400 module. Follow the steps below to setup IPMI.

4.4.1 Managed System Hardware Setup

The hardware configuration of the managed system (KINO-KBN-i2) is described below.

- Step 1:** Install an iRIS-2400 module to the IPMI module socket (refer to **Section 4.2.2**).
- Step 2:** Make sure at least one DDR3/DDR3L DIMM is installed in one of the DIMM sockets. If multiple DIMMs are installed, all of the DIMMs must be same size, same speed and same brand to get the best performance.
- Step 3:** Connect an Ethernet cable to the RJ-45 connector labeled **LAN1_USB2** (**Figure 3-29**).

4.4.2 Using the IEI iMAN Web GUI

To manage a client system from a remote console using IEI iMAN Web GUI, follow the steps below.

- Step 1:** Obtain the IP address of the managed system. It is recommended to use the IPMI Tool on the managed system to obtain the IP address. To use IPMI Tool to obtain IP address, follow the steps below:
 - a. Copy the **ipmitool.exe** file to a bootable USB flash drive.
 - b. Insert the USB flash drive to the KINO-KBN-i2
 - c. The KINO-KBN-i2 boots from the USB flash drive
 - d. Enter the following command: **ipmitool 20 30 02 01 03 00 00**
(there is a space between each two-digit number)
 - e. A serial of number shows. The last four two-digit hexadecimal numbers are the IP address. Convert the hexadecimal numbers to decimal numbers.

KINO-KBN-i2

Step 2: On the remote management console, open a web browser. Enter the managed system IP address in the web browser (**Figure 4-5**).

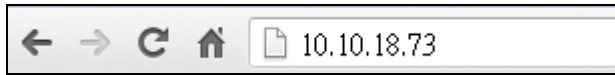

Figure 4-5: IEI iMAN Web Address

Step 3: The login page appears in the web browser.

Step 4: Enter the user name and password to login the system. The default login username and password are:

-Username: **admin**

-Password: **admin**

Step 5: Press the login button to login the system.

Step 6: The IEI iMAN Web GUI appears (**Figure 4-6**).

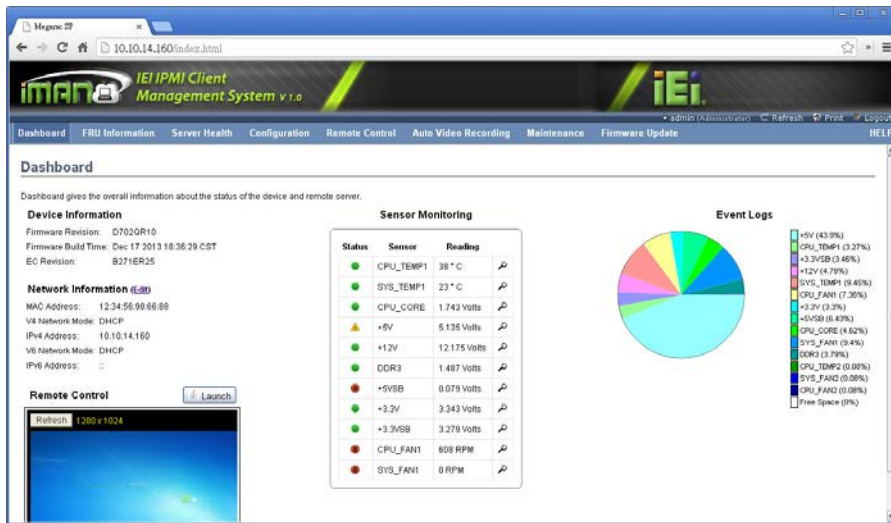

Figure 4-6: IEI iMAN Web GUI

**NOTE:**

To understand how to use the IEI iMAN Web GUI, please refer to the iRIS-2400 Web GUI user manual which can be obtained from [IEI Resource Download Center](#). The user manual describes each function in detail.

Chapter

5

BIOS

5.1 Introduction

The BIOS is programmed onto the BIOS chip. The BIOS setup program allows changes to certain system settings. This chapter outlines the options that can be changed.

5.1.1 Starting Setup

The UEFI BIOS is activated when the computer is turned on. The setup program can be activated in one of two ways.

1. Press the **DELETE** or **F2** key as soon as the system is turned on or
2. Press the **DELETE** or **F2** key when the “**Press Del to enter SETUP**” message appears on the screen.

If the message disappears before the **DELETE** or **F2** key is pressed, restart the computer and try again.

5.1.2 Using Setup

Use the arrow keys to highlight items, press **ENTER** to select, use the PageUp and PageDown keys to change entries, press **F1** for help and press **ESC** to quit. Navigation keys are shown in.

Key	Function
Up arrow	Move to the item above
Down arrow	Move to the item below
Left arrow	Move to the item on the left hand side
Right arrow	Move to the item on the right hand side
+	Increase the numeric value or make changes
-	Decrease the numeric value or make changes
Page up	Move to the next page
Page down	Move to the previous page

KINO-KBN-i2

Key	Function
Esc	Main Menu – Quit and do not save changes into CMOS Status Page Setup Menu and Option Page Setup Menu -- Exit current page and return to Main Menu
F1	General help, only for Status Page Setup Menu and Option Page Setup Menu
F9	Load optimized defaults
F10	Save changes and Exit BIOS

Table 5-1: BIOS Navigation Keys

5.1.3 Getting Help

When **F1** is pressed a small help window describing the appropriate keys to use and the possible selections for the highlighted item appears. To exit the Help Window press **Esc** or the **F1** key again.

5.1.4 Unable to Reboot after Configuration Changes

If the computer cannot boot after changes to the system configuration is made, CMOS defaults. Use the jumper described in Chapter 3.

5.1.5 BIOS Menu Bar

The **menu bar** on top of the BIOS screen has the following main items:

- Main – Changes the basic system configuration.
- Advanced – Changes the advanced system settings.
- Chipset – Changes the chipset settings.
- Boot – Changes the system boot configuration.
- Security – Sets User and Supervisor Passwords.
- Save & Exit – Selects exit options and loads default settings

The following sections completely describe the configuration options found in the menu items at the top of the BIOS screen and listed above.

5.2 Main

The **Main** BIOS menu (**BIOS Menu 1**) appears when the **BIOS Setup** program is entered. The **Main** menu gives an overview of the basic system information.

```

Aptio Setup Utility - Copyright (C) 2012 American Megatrends, Inc.
Main  Advanced  Chipset  Boot  Security  Save & Exit

BIOS Information
BIOS Vendor                American Megatrends
Core Version                4.6.5.4
Compliancy                 UEFI 2.3.1; PI 1.2
Project Version            SA98AR06.rom
Build Date and Time       10/31/2013 16:26:18

System Date                 [Fri 11/08/2013]
System Time                 [19:43:27]

Access Level                Administrator

Set the Date. Use Tab to
switch between Data
elements.

-----
<->: Select Screen
^ v: Select Item
Enter>Select
+/-: Change Opt.
F1:  General Help
F2:  Previous Values
F3:  Optimized Defaults
F4:  Save & Exit
ESC: Exit

Version 2.15.1236. Copyright (C) 2012 American Megatrends, Inc.
    
```

BIOS Menu 1: Main

→ BIOS Information

The **BIOS Information** lists a brief summary of the BIOS. The fields in **BIOS Information** cannot be changed. The items shown in the system overview include:

- **BIOS Vendor:** Installed BIOS vendor
- **Core Version:** Current BIOS version
- **Compliancy:** Current compliant version
- **Project Version:** the board version
- **Build Date and Time:** Date the current BIOS version was made

The System Overview field also has two user configurable fields:

→ System Date [xx/xx/xx]

Use the **System Date** option to set the system date. Manually enter the day, month and year.

KINO-KBN-i2

→ System Time [xx:xx:xx]

Use the **System Time** option to set the system time. Manually enter the hours, minutes and seconds.

5.3 Advanced

Use the **Advanced** menu (**BIOS Menu 2**) to configure the CPU and peripheral devices through the following sub-menus:



WARNING!

Setting the wrong values in the sections below may cause the system to malfunction. Make sure that the settings made are compatible with the hardware.

```

Aptio Setup Utility - Copyright (C) 2012 American Megatrends, Inc.
Main  Advanced  Chipset  Boot  Security  Save & Exit
-----
> ACPI Settings                               System ACPI Parameters.
> RTC Wake Settings
> Trusted Computing
> CPU Configuration
> IDE Configuration
> USB Configuration
> F81866 Super IO Configuration
> F81866 H/M Monitor
> Serial Port Console Redirection

-----
<=>: Select Screen
↑ ↓: Select Item
EnterSelect
F1  General Help
F2  Previous Values
F3  Optimized Defaults
F4  Save
ESC Exit

Version 2.15.1236. Copyright (C) 2012 American Megatrends, Inc.
    
```

BIOS Menu 2: Advanced

5.3.1 ACPI Settings

The **ACPI Settings** menu (**BIOS Menu 3**) configures the Advanced Configuration and Power Interface (ACPI) options.



BIOS Menu 3: ACPI Configuration

➔ **ACPI Sleep State [S3 only (Suspend to RAM)]**

The fields in **ACPI Sleep State** option cannot be changed.

- ➔ **S3 only (Suspend to RAM) DEFAULT** The caches are flushed and the CPU is powered off. Power to the RAM is maintained. The computer returns slower to a working state, but more power is saved.

5.3.2 RTC Wake Settings

The **RTC Wake Settings** menu (**BIOS Menu 4**) configures RTC wake event.

KINO-KBN-i2

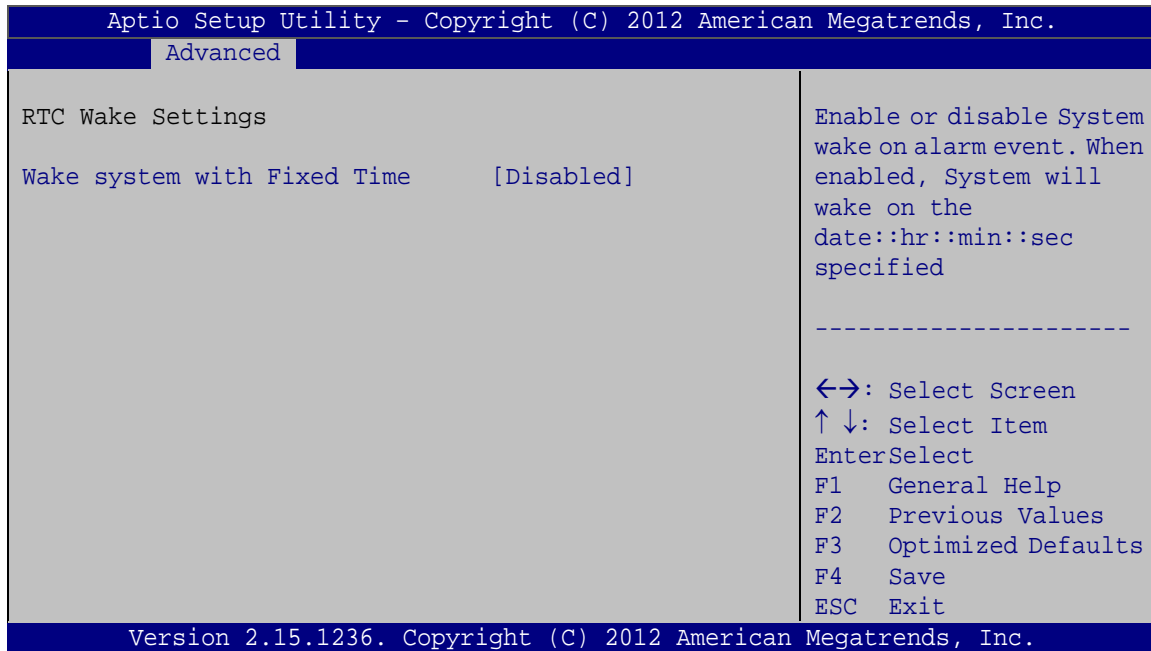

BIOS Menu 4: RTC Wake Settings

→ Wake system with Fixed Time [Disabled]

Use the **Wake system with Fixed Time** option to enable or disable the system wake on alarm event.

- **Disabled** **DEFAULT** The real time clock (RTC) cannot generate a wake event
- **Enabled** If selected, the **Wake up every day** option appears allowing you to enable to disable the system to wake every day at the specified time. Besides, the following options appear with values that can be selected:
 - Wake up date
 - Wake up hour
 - Wake up minute
 - Wake up second

After setting the alarm, the computer turns itself on from a suspend state when the alarm goes off.

5.3.3 Trusted Computing

Use the **Trusted Computing** menu (**BIOS Menu 5**) to configure settings related to the Trusted Computing Group (TCG) Trusted Platform Module (TPM).

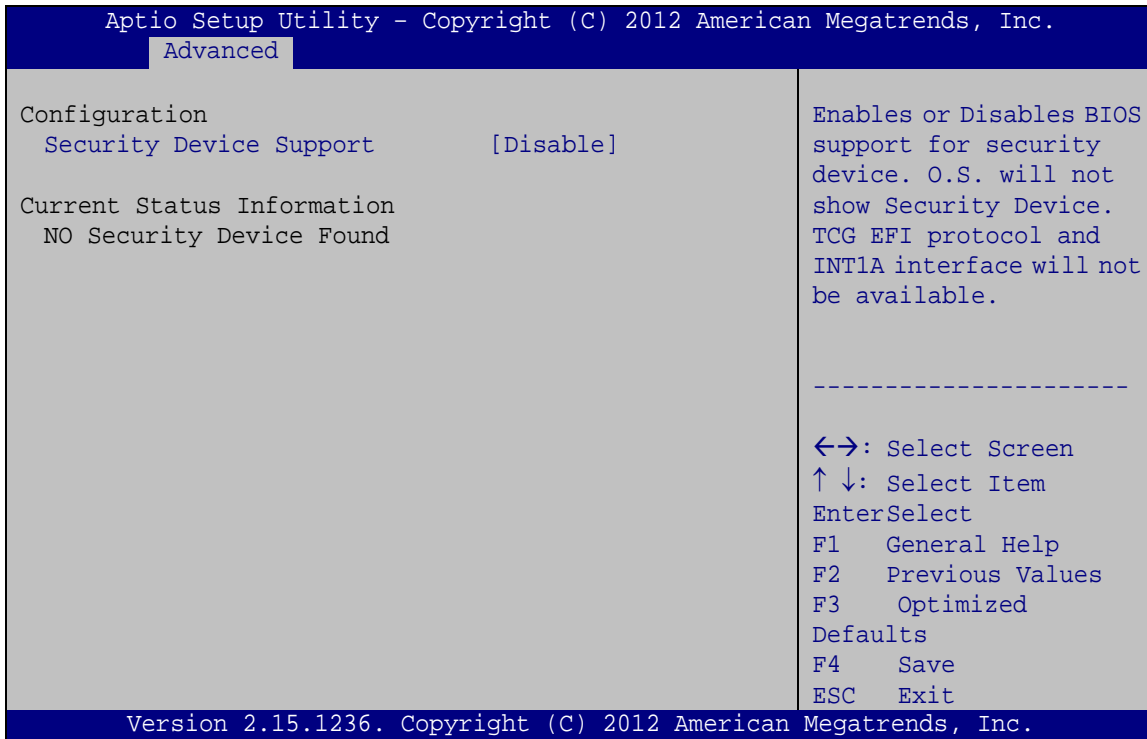

BIOS Menu 5: Trusted Computing

➔ Security Device Support [Disable]

Use the **Security Device Support** option to configure support for the security device.

- ➔ **Disable** **DEFAULT** Security device support is disabled.
- ➔ **Enable** Security device support is enabled.

KINO-KBN-i2

5.3.4 CPU Configuration

Use the **CPU Configuration** menu (**BIOS Menu 6**) to view detailed CPU specifications and configure the CPU.

```

Aptio Setup Utility - Copyright (C) 2012 American Megatrends, Inc.
  Advanced
CPU Configuration
Socket0: AMD GX-210HA SOC with Radeon(tm)HD Graphics
Dual Core Running @ 1017 MHZ 900 mV
Max Speed: 1000 MHZ  Intended Speed: 1000 MHZ
Min Speed: 800 MHZ
Microcode Patch Level: 7000106

-----Cache per Compute Unit-----
L1 Instruction Cache: 64 KB/2-way
  L1 Data Cache : 64 KB/8-way
    L2 Cache: 1024 KB/16-way
No L3 Cache Present

SVM Mode           [Enabled]
Core Leveling Mode  [Automatic mode]

Enable/disable CPU
Virtualization

-----
<->: Select Screen
^ v: Select Item
Enter>Select
F1  General Help
F2  Previous Values
F3  Optimized
Defaults
F4  Save
ESC Exit

Version 2.15.1236. Copyright (C) 2012 American Megatrends, Inc.
  
```

BIOS Menu 6: CPU Configuration

➔ SVM Mode [Enabled]

Use the **SVM Mode** option to enable or disable the CPU virtualization function.

- ➔ **Disabled** Disables the CPU virtualization function
- ➔ **Enabled** **DEFAULT** Enables the CPU virtualization function

➔ Core Leveling Mode [Automatic mode]

Use the **Core Leveling Mode** option to configure the number of the active processor cores.

- ➔ **Automatic mode** **DEFAULT** Active the processor cores by automatic mode

- ➔ **Three cores per processor** Active three of the processor cores
- ➔ **Two cores per processor** Active two of the processor cores
- ➔ **One core per processor** Active one of the processor cores

5.3.5 IDE Configuration

Use the **IDE Configuration** menu (**BIOS Menu 7**) to change and/or set the configuration of the SATA devices installed in the system.

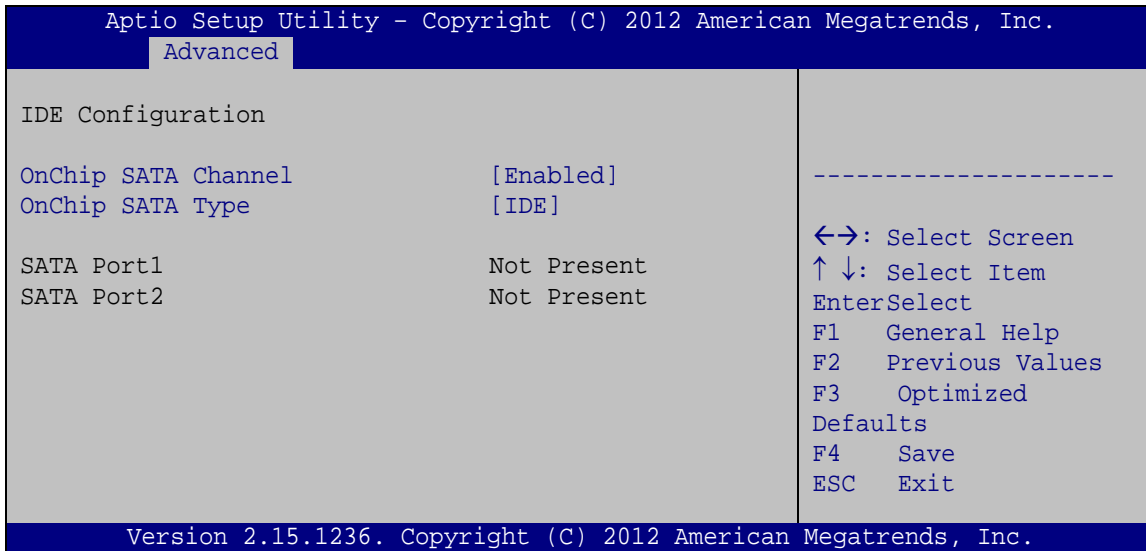

BIOS Menu 7: IDE Configuration

- ➔ **OnChip SATA Channel [Enabled]**

Use the **OnChip SATA Channel** option to configure Onchip SATA channel.

- ➔ **Disabled** Disables Onchip SATA channel.
- ➔ **Enabled DEFAULT** Enables Onchip SATA channel.

- ➔ **OnChip SATA Type [IDE]**

Use the **OnChip SATA Type** option to configure Onchip SATA type.

KINO-KBN-i2

- ➔ **IDE** **DEFAULT** Configures SATA devices as normal IDE device.
- ➔ **AHCI** Configures SATA devices as AHCI device.

5.3.6 USB Configuration

Use the **USB Configuration** menu (**BIOS Menu 8**) to read USB configuration information and configure the USB settings.

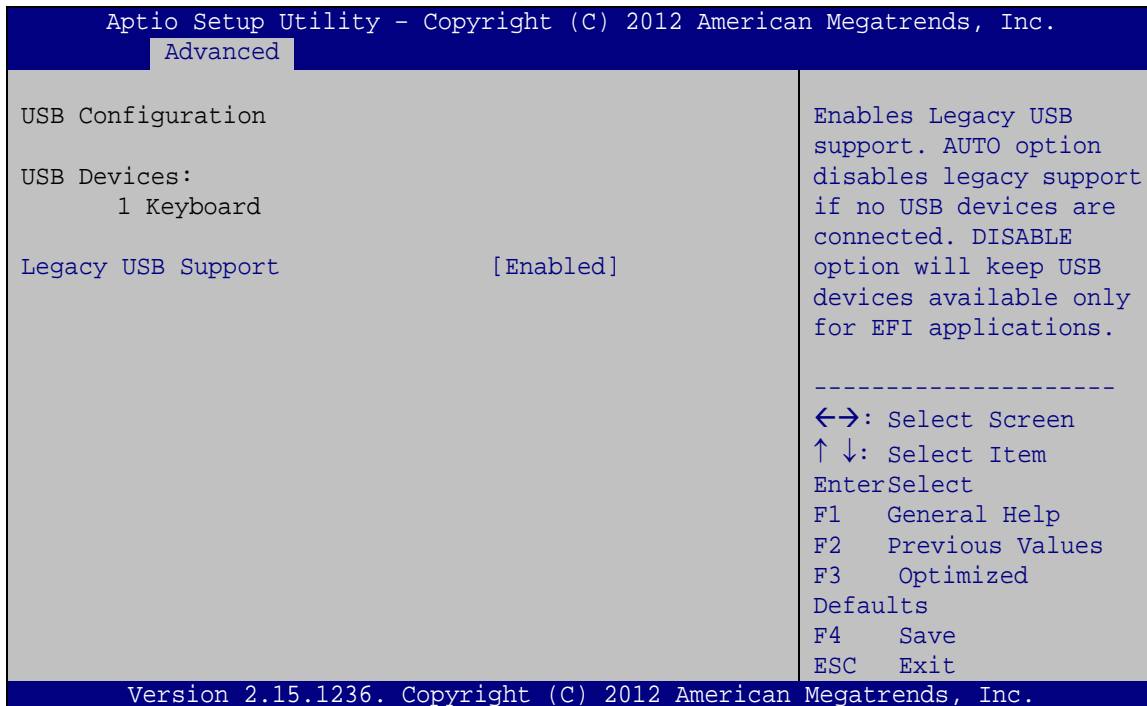

BIOS Menu 8: USB Configuration

➔ **USB Devices**

The **USB Devices Enabled** field lists the USB devices that are enabled on the system

➔ **Legacy USB Support [Enabled]**

Use the **Legacy USB Support** BIOS option to enable USB mouse and USB keyboard support. Normally if this option is not enabled, any attached USB mouse or USB keyboard does not become available until a USB compatible operating system is fully booted with all USB drivers loaded. When this option is enabled, any attached USB mouse or USB

keyboard can control the system even when there is no USB driver loaded onto the system.

- ➔ **Enabled** **DEFAULT** Legacy USB support enabled
- ➔ **Disabled** Legacy USB support disabled
- ➔ **Auto** Legacy USB support disabled if no USB devices are connected

5.3.7 F81866 Super IO Configuration

Use the **F81866 Super IO Configuration** menu (**BIOS Menu 9**) to set or change the configurations for the serial ports.

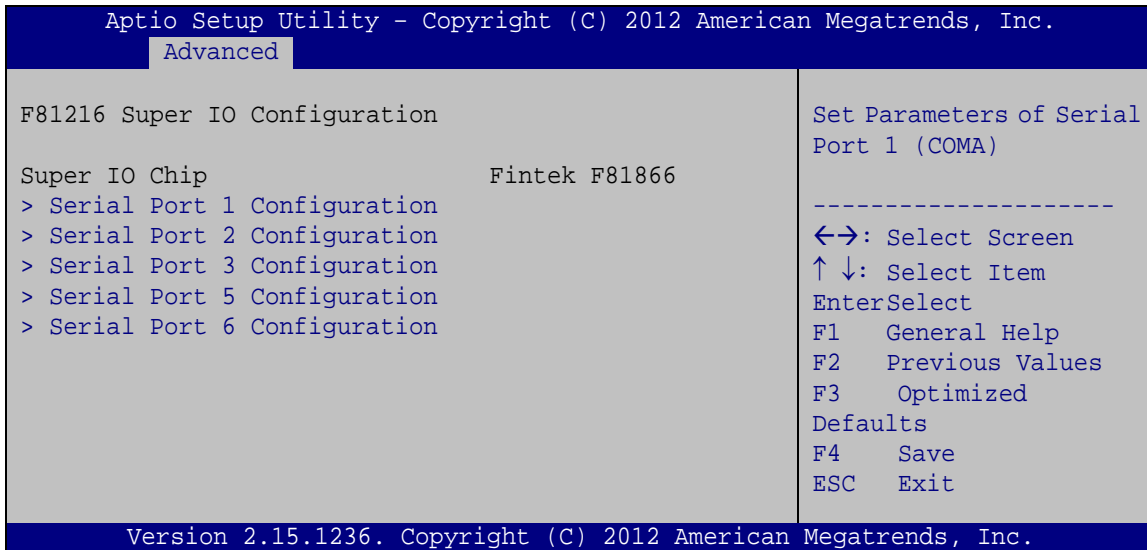

BIOS Menu 9: Super IO Configuration

KINO-KBN-i2

5.3.7.1 Serial Port n Configuration

Use the **Serial Port n Configuration** menu (**BIOS Menu 10**) to configure the serial port n.

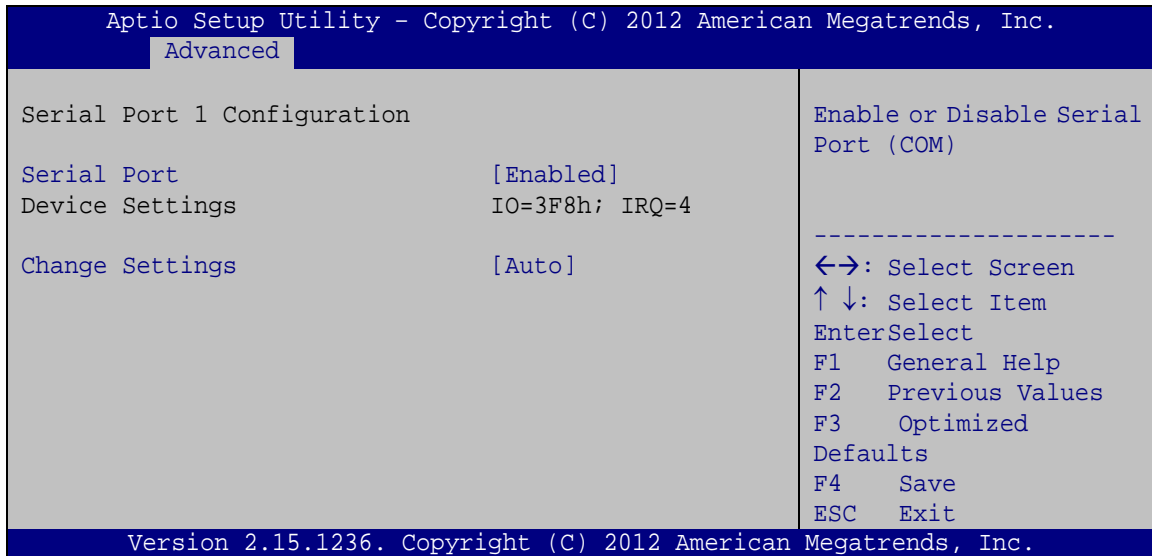

BIOS Menu 10: Serial Port n Configuration Menu

5.3.7.1.1 Serial Port 1 Configuration

→ Serial Port [Enabled]

Use the **Serial Port** option to enable or disable the serial port.

- **Disabled** Disable the serial port
- **Enabled** **DEFAULT** Enable the serial port

→ Change Settings [Auto]

Use the **Change Settings** option to change the serial port IO port address and interrupt address.

- **Auto** **DEFAULT** The serial port IO port address and interrupt address are automatically detected.
- **IO=3F8h; IRQ=4** Serial Port I/O port address is 3F8h and the interrupt address is IRQ4

- ➔ IO=3F8h; IRQ=3, 4,5,6,7,10,11,12 Serial Port I/O port address is 3F8h and the interrupt address is IRQ3,4,5,6,7,10,11,12
- ➔ IO=2F8h; IRQ=3, 4,5,6,7,10,11,12 Serial Port I/O port address is 2F8h and the interrupt address is IRQ3,4,5,6,7,10,11,12
- ➔ IO=3E8h; IRQ=3, 4,5,6,7,10,11,12 Serial Port I/O port address is 3E8h and the interrupt address is IRQ3,4,5,6,7,10,11,12
- ➔ IO=2E8h; IRQ=3, 4,5,6,7,10,11,12 Serial Port I/O port address is 2E8h and the interrupt address is IRQ3,4,5,6,7,10,11,12

5.3.7.1.2 Serial Port 2 Configuration

➔ Serial Port [Enabled]

Use the **Serial Port** option to enable or disable the serial port.

- ➔ Disabled Disable the serial port
- ➔ Enabled **DEFAULT** Enable the serial port

➔ Change Settings [Auto]

Use the **Change Settings** option to change the serial port IO port address and interrupt address.

- ➔ Auto **DEFAULT** The serial port IO port address and interrupt address are automatically detected.
- ➔ IO=2F8h; IRQ=3 Serial Port I/O port address is 2F8h and the interrupt address is IRQ3
- ➔ IO=3F8h; IRQ=3, 4,5,6,7,10,11,12 Serial Port I/O port address is 3F8h and the interrupt address is IRQ3,4,5,6,7,10,11,12
- ➔ IO=2E8h; IRQ=3, 4,5,6,7,10,11,12 Serial Port I/O port address is 2E8h and the interrupt address is IRQ3,4,5,6,7,10,11,12
- ➔ IO=3E8h; IRQ=3, 4,5,6,7,10,11,12 Serial Port I/O port address is 3E8h and the interrupt address is IRQ3,4,5,6,7,10,11,12

KINO-KBN-i2

- ➔ **IO=2E8h; IRQ=3, 4,5,6,7,10,11,12** Serial Port I/O port address is 2E8h and the interrupt address is IRQ3,4,5,6,7,10,11,12

5.3.7.1.3 Serial Port 3 Configuration

➔ Serial Port [Enabled]

Use the **Serial Port** option to enable or disable the serial port.

- ➔ **Disabled** Disable the serial port
- ➔ **Enabled DEFAULT** Enable the serial port

➔ Change Settings [Auto]

Use the **Change Settings** option to change the serial port IO port address and interrupt address.

- ➔ **Auto DEFAULT** The serial port IO port address and interrupt address are automatically detected.
- ➔ **IO=3E8h; IRQ=10** Serial Port I/O port address is 3E8h and the interrupt address is IRQ10
- ➔ **IO=3E8h; IRQ=3, 4,5,6,7,10,11,12** Serial Port I/O port address is 3E8h and the interrupt address is IRQ3,4,5,6,7,10,11,12
- ➔ **IO=2E8h; IRQ=3, 4,5,6,7,10,11,12** Serial Port I/O port address is 2E8h and the interrupt address is IRQ3,4,5,6,7,10,11,12
- ➔ **IO=2D0h; IRQ=3, 4,5,6,7,10,11,12** Serial Port I/O port address is 2D0h and the interrupt address is IRQ3,4,5,6,7,10,11,12
- ➔ **IO=2D8h; IRQ=3, 4,5,6,7,10,11,12** Serial Port I/O port address is 2D8h and the interrupt address is IRQ3,4,5,6,7,10,11,12

5.3.7.1.4 Serial Port 5 Configuration

→ Serial Port [Enabled]

Use the **Serial Port** option to enable or disable the serial port.

- **Disabled** Disable the serial port
- **Enabled** **DEFAULT** Enable the serial port

→ Change Settings [Auto]

Use the **Change Settings** option to change the serial port IO port address and interrupt address.

- **Auto** **DEFAULT** The serial port IO port address and interrupt address are automatically detected.
- **IO=2D0h; IRQ=10** Serial Port I/O port address is 2D0h and the interrupt address is IRQ10
- **IO=3E8h; IRQ=3, 4,5,6,7,10,11,12** Serial Port I/O port address is 3E8h and the interrupt address is IRQ3,4,5,6,7,10,11,12
- **IO=2E8h; IRQ=3, 4,5,6,7,10,11,12** Serial Port I/O port address is 2E8h and the interrupt address is IRQ3,4,5,6,7,10,11,12
- **IO=2D0h; IRQ=3, 4,5,6,7,10,11,12** Serial Port I/O port address is 2D0h and the interrupt address is IRQ3,4,5,6,7,10,11,12
- **IO=2D8h; IRQ=3, 4,5,6,7,10,11,12** Serial Port I/O port address is 2D8h and the interrupt address is IRQ3,4,5,6,7,10,11,12

5.3.7.1.5 Serial Port 6 Configuration

→ Serial Port [Enabled]

Use the **Serial Port** option to enable or disable the serial port.

KINO-KBN-i2

- ➔ **Disabled** Disable the serial port
- ➔ **Enabled** **DEFAULT** Enable the serial port

➔ **Change Settings [Auto]**

Use the **Change Settings** option to change the serial port IO port address and interrupt address.

- ➔ **Auto** **DEFAULT** The serial port IO port address and interrupt address are automatically detected.
- ➔ **IO=2D8h; IRQ=10** Serial Port I/O port address is 2D8h and the interrupt address is IRQ10
- ➔ **IO=3E8h; IRQ=3, 4,5,6,7,10,11,12** Serial Port I/O port address is 3E8h and the interrupt address is IRQ3,4,5,6,7,10,11,12
- ➔ **IO=2E8h; IRQ=3, 4,5,6,7,10,11,12** Serial Port I/O port address is 2E8h and the interrupt address is IRQ3,4,5,6,7,10,11,12
- ➔ **IO=2D0h; IRQ=3, 4,5,6,7,10,11,12** Serial Port I/O port address is 2D0h and the interrupt address is IRQ3,4,5,6,7,10,11,12
- ➔ **IO=2D8h; IRQ=3, 4,5,6,7,10,11,12** Serial Port I/O port address is 2D8h and the interrupt address is IRQ3,4,5,6,7,10,11,12

5.3.8 F81866 H/W Monitor

The **F8186 H/W Monitor** menu (**BIOS Menu 11**) shows the operating temperature, fan speeds and system voltages.

```

Aptio Setup Utility - Copyright (C) 2012 American Megatrends, Inc.
Advanced
PC Health Status
Smart Fan Function [Enabled]
> Smart Fan Mode Configuration
CPU Temperature      :-128 C
SYS Temperature     :+29 C
FAN1 Speed           :N/A V
FAN2 Speed           :N/A V
-----
<->: Select Screen
↑ ↓: Select Item
EnterSelect
F1   General Help
F2   Previous Values
F3   Optimized
Defaults
F4   Save
ESC  Exit
Version 2.15.1236. Copyright (C) 2012 American Megatrends, Inc.

```

BIOS Menu 11: Hardware Health Configuration

→ PC Health Status

The following system parameters and values are shown. The system parameters that are monitored are:

- System Temperatures:
 - CPU Temperature
 - SYS Temperature
- Fans Speeds:
 - FAN1 Speed
 - FAN2 Speed

→ Smart Fan Function [Enabled]

Use the **Smart Fan Function** option to enable or disable the smart fan function.

KINO-KBN-i2

- ➔ **Disabled** Disables the smart fan function.
- ➔ **Enabled** **DEFAULT** Enables the smart fan function.

5.3.8.1 Smart Fan Mode Configuration

Use the **Smart Fan Mode Configuration** submenu (**BIOS Menu 12**) to configure the smart fan temperature and speed settings.

```

Aptio Setup Utility - Copyright (C) 2012 American Megatrends, Inc.
Advanced
Smart Fan Mode Configuration
FAN1 Smart Fan Control      [Auto Duty-Cycle Mode]
CPU Temperature 1          60
CPU Temperature 2          50
CPU Temperature 3          40
CPU Temperature 4          30
FAN2 Smart Fan Control      [Auto Duty-Cycle Mode]
SYS Temperature 1          60
SYS Temperature 2          50
SYS Temperature 3          40
SYS Temperature 4          30
Smart Fan Mode Select
-----
<->: Select Screen
↑ ↓: Select Item
Enter>Select
+ - Change Opt.
F1  General Help
F2  Previous Values
F3  Optimized Defaults
F4  Save & Exit
ESC Exit
Version 2.15.1236. Copyright (C) 2012 American Megatrends, Inc.
  
```

BIOS Menu 12: FAN 1 Configuration

➔ **FAN1 Smart Fan Control [Auto Duty-Cycle Mode]**

Use the **FAN1 Smart Fan Control** option to configure the CPU Smart Fan.

- ➔ **Manual Duty Mode** The fan spins at the speed set in Manual by Duty Cycle settings
- ➔ **Auto Duty-Cycle Mode** **DEFAULT** The fan adjusts its speed using Auto by Duty-Cycle settings

→ **CPU Temperature n**

Use the + or – key to change the fan **CPU Temperature n** value. Enter a decimal number between 1 and 100.

→ **FAN2 Smart Fan Control [Auto Duty-Cycle Mode]**

Use the **FAN2 Smart Fan Control** option to configure the System Smart Fan.

- | | |
|-------------------------------|---|
| → Manual Duty Mode | The fan spins at the speed set in Manual by Duty Cycle settings |
| → Auto Duty-Cycle Mode | DEFAULT The fan adjusts its speed using Auto by Duty-Cycle settings |

→ **SYS Temperature n**

Use the + or – key to change the fan **SYS Temperature n** value. Enter a decimal number between 1 and 100.

5.3.9 Serial Port Console Redirection

The **Serial Port Console Redirection** menu (**BIOS Menu 13**) allows the console redirection options to be configured. Console redirection allows users to maintain a system remotely by re-directing keyboard input and text output through the serial port.

KINO-KBN-i2

```

Aptio Setup Utility - Copyright (C) 2012 American Megatrends, Inc.
  Advanced
COM1
  Console Redirection          [Disabled]
> Console Redirection Settings
COM2
  Console Redirection          [Disabled]
> Console Redirection Settings
COM3
  Console Redirection          [Disabled]
> Console Redirection Settings
COM5
  Console Redirection          [Disabled]
> Console Redirection Settings
COM6
  Console Redirection          [Disabled]
> Console Redirection Settings
-----
<->: Select Screen
↑ ↓: Select Item
Enter>Select
+ - Change Opt.
F1  General Help
F2  Previous Values
F3  Optimized Defaults
F4  Save
ESC Exit
Version 2.15.1236. Copyright (C) 2012 American Megatrends, Inc.
  
```

BIOS Menu 13: Serial Port Console Redirection

➔ Console Redirection [Disabled]

Use **Console Redirection** option to enable or disable the console redirection function.

- ➔ **Disabled** **DEFAULT** Disabled the console redirection function
- ➔ **Enabled** Enabled the console redirection function

5.3.9.1 Console Redirection Settings

The **Console Redirection Settings** menu (**BIOS Menu 14**) allows the console redirection options to be configured. The option is active when Console Redirection option is enabled.

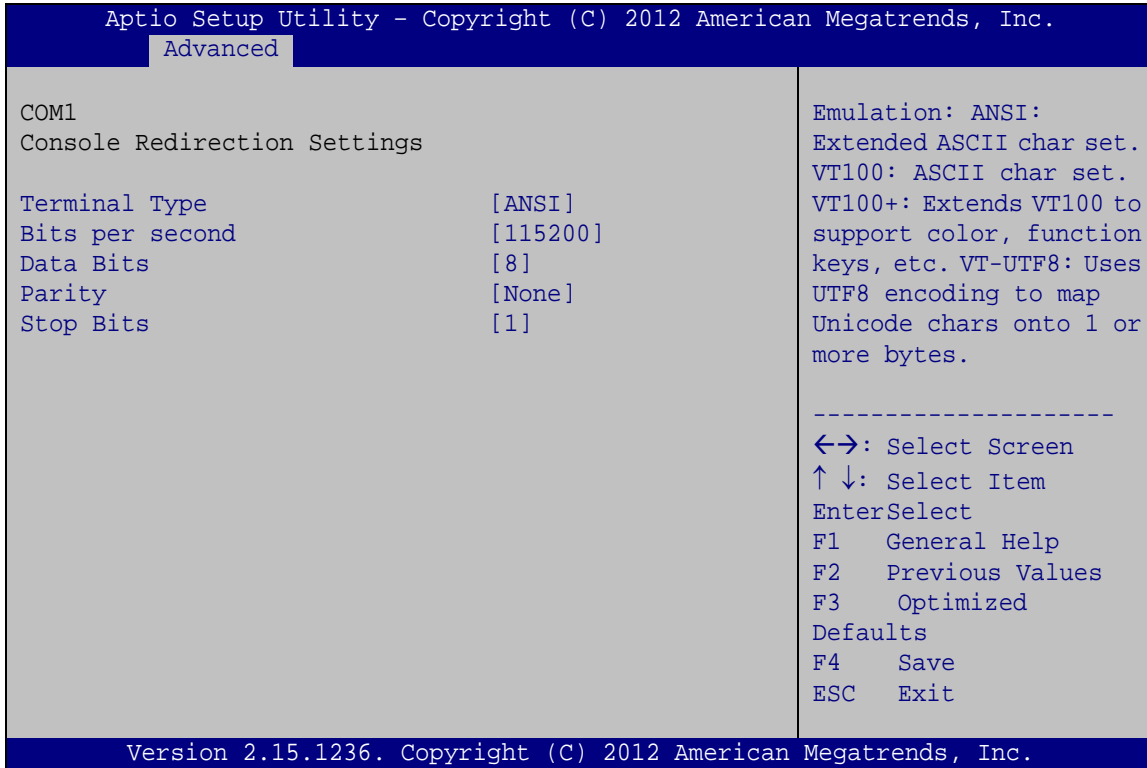

BIOS Menu 14: Console Redirection Settings

➔ **Terminal Type [ANSI]**

Use the **Terminal Type** option to specify the remote terminal type.

- ➔ **VT100** The target terminal type is VT100
- ➔ **VT100+** The target terminal type is VT100+
- ➔ **VT-UTF8** The target terminal type is VT-UTF8
- ➔ **ANSI** **DEFAULT** The target terminal type is ANSI

➔ **Bits per second [115200]**

Use the **Bits per second** option to specify the serial port transmission speed. The speed must match the other side. Long or noisy lines may require lower speeds.

- ➔ **9600** Sets the serial port transmission speed at 9600.
- ➔ **19200** Sets the serial port transmission speed at 19200.

KINO-KBN-i2

- **38400** Sets the serial port transmission speed at 38400.
- **57600** Sets the serial port transmission speed at 57600.
- **115200** **DEFAULT** Sets the serial port transmission speed at 115200.

→ **Data Bits [8]**

Use the **Data Bits** option to specify the number of data bits.

- **7** Sets the data bits at 7.
- **8** **DEFAULT** Sets the data bits at 8.

→ **Parity [None]**

Use the **Parity** option to specify the parity bit that can be sent with the data bits for detecting the transmission errors.

- **None** **DEFAULT** No parity bit is sent with the data bits.
- **Even** The parity bit is 0 if the number of ones in the data bits is even.
- **Odd** The parity bit is 0 if the number of ones in the data bits is odd.
- **Mark** The parity bit is always 1. This option does not provide error detection.
- **Space** The parity bit is always 0. This option does not provide error detection.

→ **Stop Bits [1]**

Use the **Stop Bits** option to specify the number of stop bits used to indicate the end of a serial data packet. Communication with slow devices may require more than 1 stop bit.

- **1** **DEFAULT** Sets the number of stop bits at 1.
- **2** Sets the number of stop bits at 2.

5.4 Chipset

Use the **Chipset** menu (**BIOS Menu 15**) to access the PCH-IO and System Agent (SA) configuration menus.



WARNING!

Setting the wrong values for the Chipset BIOS selections in the Chipset BIOS menu may cause the system to malfunction.

```
Aptio Setup Utility - Copyright (C) 2012 American Megatrends, Inc.
Main   Advanced  Chipset  Boot   Security  Save & Exit
-----
> GFX Configuration          GFX Configuration
> South Bridge
> North Bridge

-----
<=>: Select Screen
↑ ↓: Select Item
Enter>Select
F1   General Help
F2   Previous Values
F3   Optimized
Defaults
F4   Save
ESC  Exit

Version 2.15.1236. Copyright (C) 2012 American Megatrends, Inc.
```

BIOS Menu 15: Chipset

5.4.1 GFX Configuration

Use the **GFX Configuration** menu (**BIOS Menu 16**) to configure the video device connected to the system.

KINO-KBN-i2

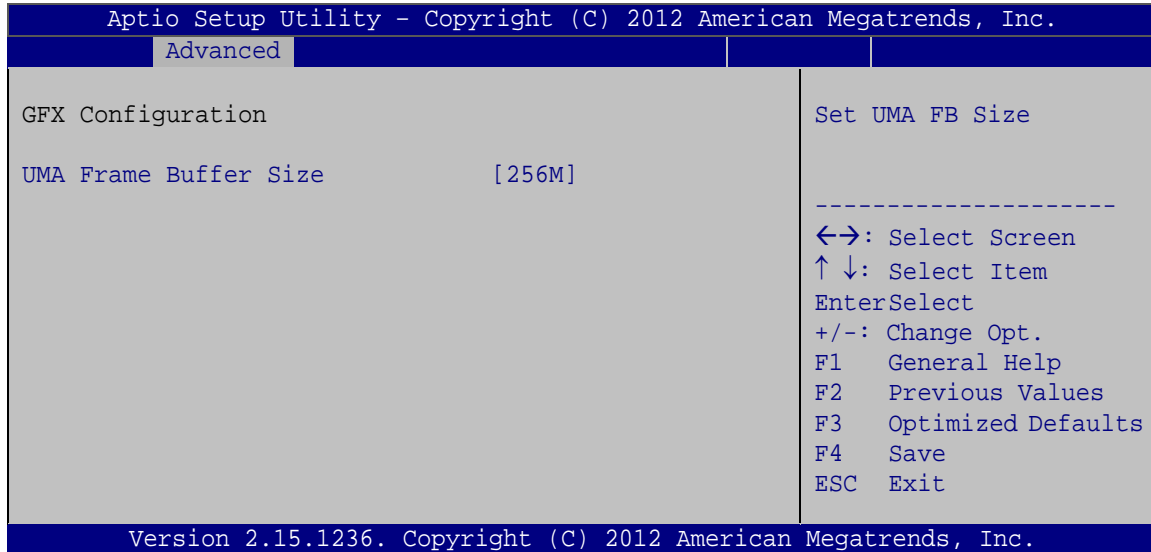
**BIOS Menu 16: GFX Configuration****→ UMA Frame Buffer Size [256M]**

Use the **UMA Frame Buffer** option to specify the amount of system memory that can be allocated as graphics memory. Configuration options are listed below.

- 32M
- 64M
- 128M
- 256M **DEFAULT**
- 512M

5.4.2 South Bridge Configuration

Use the **South Bridge Configuration** menu (**BIOS Menu 17**) to configure the South Bridge chipset.

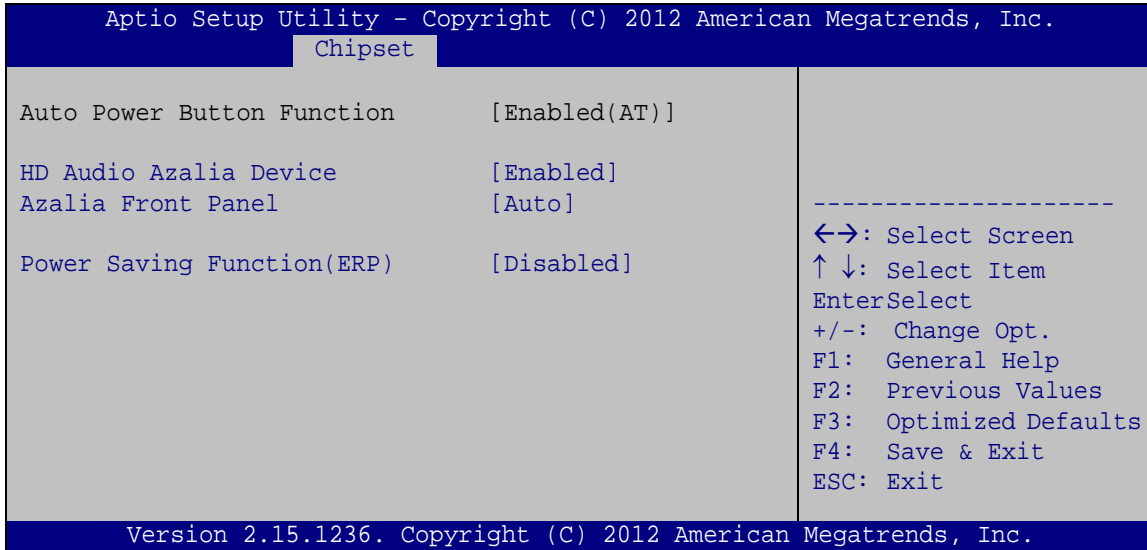

BIOS Menu 17: South Bridge Configuration

→ **HD Audio Azalia Device [Enabled]**

Use the **HD Audio Azalia Device** option to enable or disable the High Definition Audio controller.

- **Auto** The onboard High Definition Audio controller will be enabled if present, disabled otherwise.
- **Disabled** The onboard High Definition Audio controller is disabled
- **Enabled DEFAULT** The onboard High Definition Audio controller is detected automatically and enabled

→ **Azalia Front Panel [Enabled]**

Use the **Azalia Front Panel** option to enable or disable the front panel audio controller.

- **Auto** The front panel audio controller will be enabled if present, disabled otherwise.
- **Disabled** The front panel audio controller is disabled
- **Enabled DEFAULT** The front panel audio controller is detected automatically and enabled

KINO-KBN-i2**→ Power Saving Function(ERP) [Disabled]**

Use the **Power Saving Function** BIOS option to enable or disable the power saving function.

- **Disabled** **DEFAULT** Power saving function is disabled.
- **Enabled** Power saving function is enabled. It will reduce power consumption when the system is off.

5.4.3 North Bridge Configuration

Use the **North Bridge** menu (**BIOS Menu 18**) to view the memory information.

```

Aptio Setup Utility - Copyright (C) 2012 American Megatrends, Inc.
Chipset
North Bridge Configuration
Memory Information
Memory Clock:1333 MHZ
Total Memory:2048 MB (DDR3)
Dimm0: Not Present
Dimm1: size = 2048MB, speed = 1333MHZ
-----
←→: Select Screen
↑ ↓: Select Item
EnterSelect
+ - Change Opt.
F1 General Help
F2 Previous Values
F3 Optimized Defaults
F4 Save & Exit
ESC Exit
Version 2.15.1236. Copyright (C) 2012 American Megatrends, Inc.

```

BIOS Menu 18: North Bridge Configuration

5.5 Boot

Use the **Boot** menu (**BIOS Menu 19**) to configure system boot options.

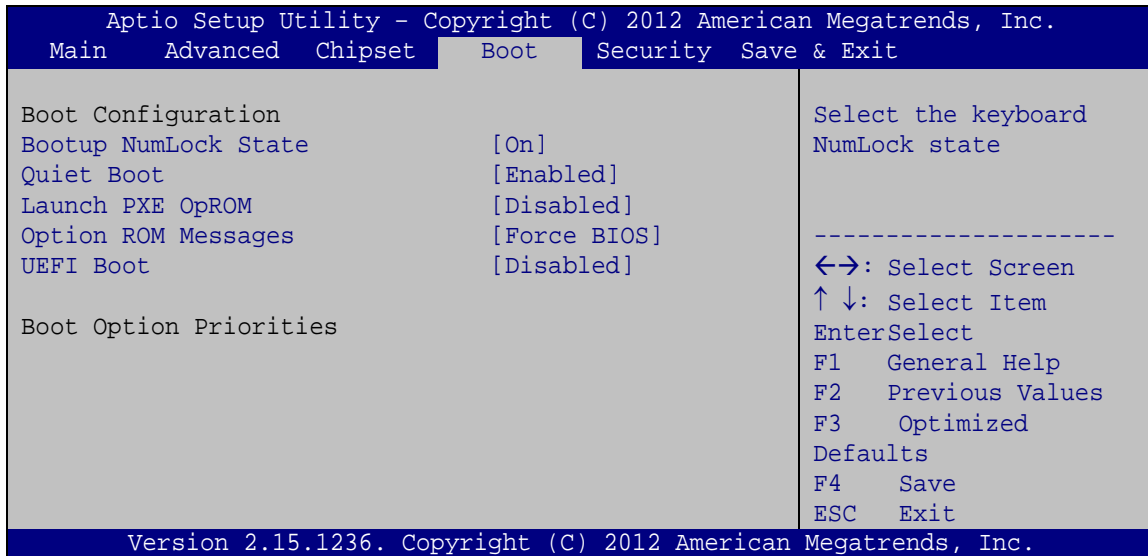

BIOS Menu 19: Boot

→ Bootup NumLock State [On]

Use the **Bootup NumLock State** BIOS option to specify if the number lock setting must be modified during boot up.

- **On** **DEFAULT** Allows the Number Lock on the keyboard to be enabled automatically when the computer system boots up. This allows the immediate use of the 10-key numeric keypad located on the right side of the keyboard. To confirm this, the Number Lock LED light on the keyboard is lit.

- **Off** Does not enable the keyboard Number Lock automatically. To use the 10-keys on the keyboard, press the Number Lock key located on the upper left-hand corner of the 10-key pad. The Number Lock LED on the keyboard lights up when the Number Lock is engaged.

KINO-KBN-i2

→ Quiet Boot [Enabled]

Use the **Quiet Boot** BIOS option to select the screen display when the system boots.

- **Disabled** Normal POST messages displayed
- **Enabled** **DEFAULT** OEM Logo displayed instead of POST messages

→ Launch PXE OpROM [Disabled]

Use the **Launch PXE OpROM** option to enable or disable boot option for legacy network devices.

- **Disabled** **DEFAULT** Ignore all PXE Option ROMs
- **Enabled** Load PXE Option ROMs.

→ Option ROM Messages [Force BIOS]

Use the **Option ROM Messages** option to set the Option ROM display mode.

- **Force BIOS** **DEFAULT** Sets display mode to force BIOS.
- **Keep Current** Sets display mode to current.

→ UEFI Boot [Disabled]

Use the **UEFI Boot** option to enable or disable to boot from the UEFI devices.

- **Auto** If the first boot HDD is GPT then enable UEFI boot options, otherwise disable,
- **Enabled** Boot from UEFI devices is enabled.
- **Disabled** **DEFAULT** Boot from UEFI devices is disabled.

→ Boot Option Priority

Use the **Boot Option Priority** function to set the system boot sequence from the available devices. The drive sequence also depends on the boot sequence in the individual device section.

5.6 Security

Use the **Security** menu (**BIOS Menu 20**) to set system and user passwords.

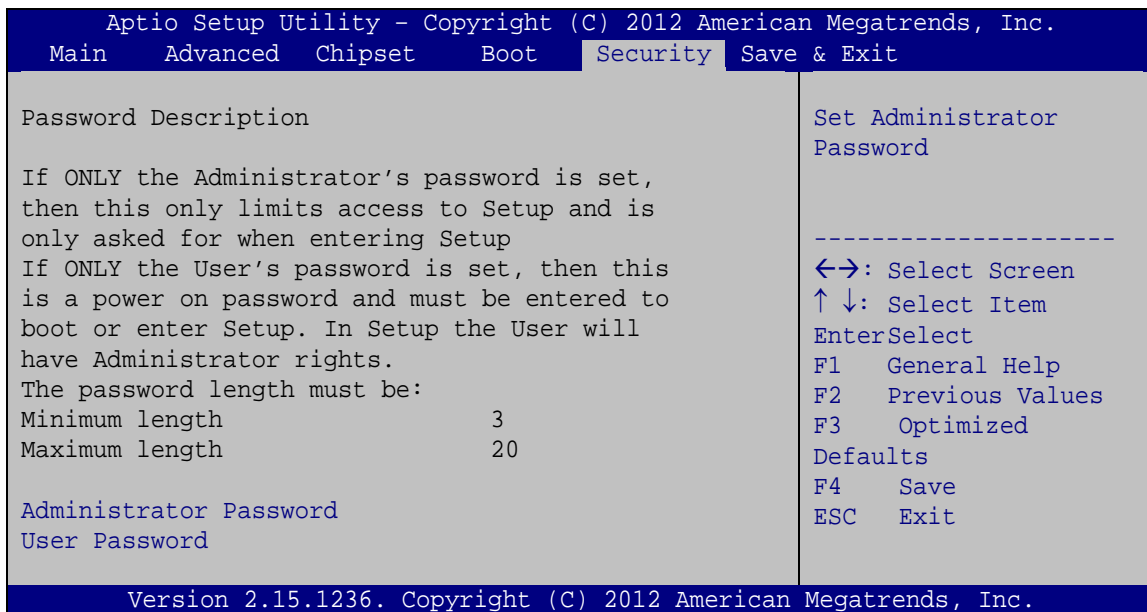

BIOS Menu 20: Security

→ Administrator Password

Use the **Administrator Password** to set or change a administrator password.

→ User Password

Use the **User Password** to set or change a user password.

5.7 Save & Exit

Use the **Save & Exit** menu (**BIOS Menu 21**) to load default BIOS values, optimal failsafe values and to save configuration changes.

KINO-KBN-i2

```

Aptio Setup Utility - Copyright (C) 2012 American Megatrends, Inc.
Main   Advanced   Chipset   Boot   Security   Save & Exit

Save Changes and Reset
Discard Changes and Reset

Restore Defaults
Save as User Defaults
Restore User Defaults

Reset the system after
saving the changes.

-----
←→: Select Screen
↑ ↓: Select Item
Enter>Select
F1   General Help
F2   Previous Values
F3   Optimized
Defaults
F4   Save
ESC  Exit

Version 2.15.1236. Copyright (C) 2012 American Megatrends, Inc.

```

BIOS Menu 21:Exit**→ Save Changes and Reset**

Use the **Save Changes and Reset** option to save the changes made to the BIOS options and to exit the BIOS configuration setup program.

→ Discard Changes and Reset

Use the **Discard Changes and Reset** option to exit the system without saving the changes made to the BIOS configuration setup program.

→ Restore Defaults

Use the **Restore Defaults** option to load the optimal default values for each of the parameters on the Setup menus. **F3 key can be used for this operation.**

→ Save as User Defaults

Use the **Save as User Defaults** option to save the changes done so far as user defaults.

→ Restore User Defaults

Use the **Restore User Defaults** option to restore the user defaults to all the setup options.

Chapter

5

Software

KINO-KBN-i2

6.1 Available Drivers

All the drivers for the KINO-KBN-i2 are available on IEI Resource Download Center (<https://download.ieiworld.com>). Type KINO-KBN-i2 and press Enter to find all the relevant software, utilities, and documentation.

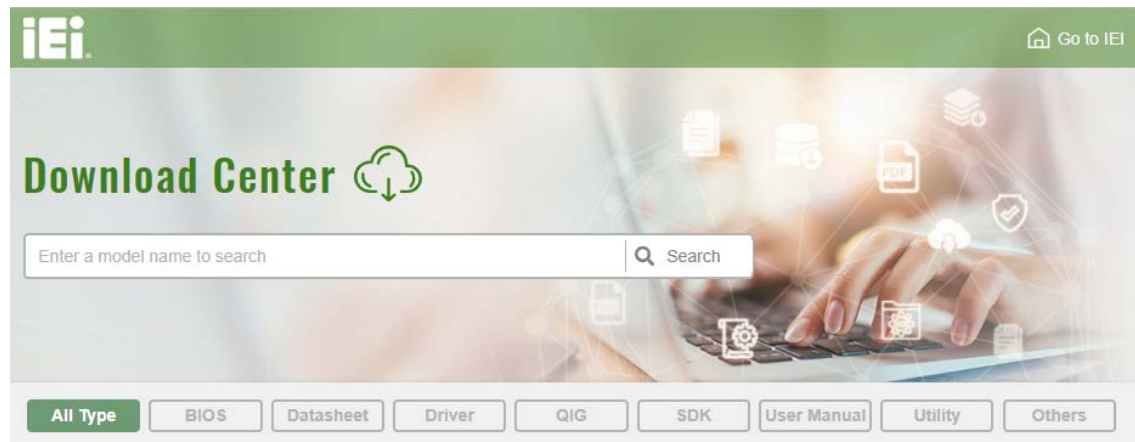
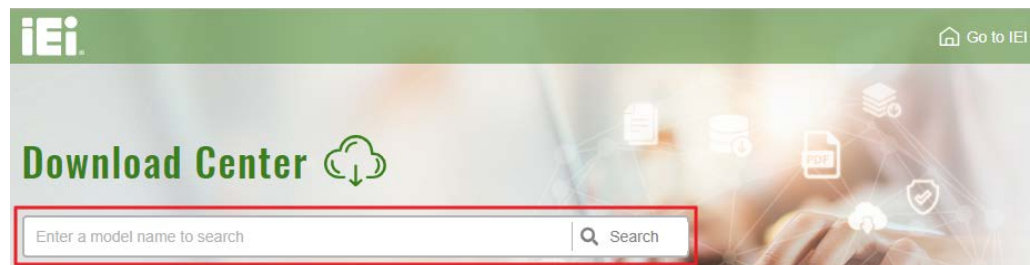

Figure 6-1: IEI Resource Download Center

6.2 Driver Download

To download drivers from IEI Resource Download Center, follow the steps below.

Step 1: Go to <https://download.ieiworld.com>. Type KINO-KBN-i2 and press Enter.



Step 2: All product-related software, utilities, and documentation will be listed. You can choose **Driver** to filter the result.

[All Type](#)
[BIOS](#)
[Datasheet](#)
[Driver](#)
[QIG](#)
[SDK](#)
[User Manual](#)
[Utility](#)
[Others](#)

WAFER-BT-i1 [Product Info](#)

[Embedded Computer](#) ▶ [Single Board Computer](#) ▶ [Embedded Board](#)
 3.5" SBC with Intel® 22nm Atom™/Celeron® on-board SoC

Driver

File Name	Published	Version	File Checksum
7B000-001033-RS V2.3.iso (2.23 GB)	2017/10/03	2.30	3B2DB1F792779A93A8F50DDDBC3943E30

Step 3: Click the driver file name on the page and you will be prompted with the following window. You can download the entire ISO file (❶), or double click an individual item to find its driver file and click the file name to download (❷).

7B000-001168-RS_V1.4.iso

❶ [Click here to download entire ISO file. \(2.99 GB\)](#)

* Download individual file *

- Docs
 - ❷ 1.Chipset
 - 10.1.1.12.zip (2.7 MB)
 - 2.VGA
 - 3.Audio
 - 4.Lan
 - 5.USB 3.0
 - 6.Serial IO
 - 7.TXE
 - 8.Manual



NOTE:

To install software from the downloaded ISO image file in Windows 8, 8.1 or 10, double-click the ISO file to mount it as a virtual drive to view its content. On Windows 7 system, an additional tool (such as Virtual CD-ROM Control Panel from Microsoft) is needed to mount the file.

Appendix

A

Regulatory Compliance

DECLARATION OF CONFORMITY



This equipment has been tested and found to comply with specifications for CE marking. If the user modifies and/or installs other devices in the equipment, the CE conformity declaration may no longer apply.

FCC WARNING



This equipment complies with Part 15 of the FCC Rules. Operation is subject to the following two conditions:

- This device may not cause harmful interference, and
- This device must accept any interference received, including interference that may cause undesired operation.

This equipment has been tested and found to comply with the limits for a Class A digital device, pursuant to part 15 of the FCC Rules. These limits are designed to provide reasonable protection against harmful interference when the equipment is operated in a commercial environment. This equipment generates, uses, and can radiate radio frequency energy and, if not installed and used in accordance with the instruction manual, may cause harmful interference to radio communications. Operation of this equipment in a residential area is likely to cause harmful interference in which case the user will be required to correct the interference at his own expense.

Appendix

B

Product Disposal

**CAUTION:**

Risk of explosion if battery is replaced by an incorrect type. Only certified engineers should replace the on-board battery.

Dispose of used batteries according to instructions and local regulations.

- Outside the European Union – If you wish to dispose of used electrical and electronic products outside the European Union, please contact your local authority so as to comply with the correct disposal method.
- Within the European Union – The device that produces less waste and is easier to recycle is classified as electronic device in terms of the European Directive 2012/19/EU (WEEE), and must not be disposed of as domestic garbage.

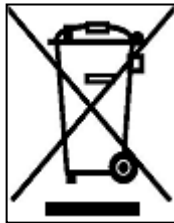

EU-wide legislation, as implemented in each Member State, requires that waste electrical and electronic products carrying the mark (left) must be disposed of separately from normal household waste. This includes monitors and electrical accessories, such as signal cables or power cords. When you need to dispose of your device, please follow the guidance of your local authority, or ask the shop where you purchased the product. The mark on electrical and electronic products only applies to the current European Union Member States.

Please follow the national guidelines for electrical and electronic product disposal.

Appendix

C

BIOS Menu Options

<input type="checkbox"/>	BIOS Information	68
<input type="checkbox"/>	System Date [xx/xx/xx]	68
<input type="checkbox"/>	System Time [xx:xx:xx]	69
<input type="checkbox"/>	ACPI Sleep State [S3 only (Suspend to RAM)]	70
<input type="checkbox"/>	Wake system with Fixed Time [Disabled]	71
<input type="checkbox"/>	Security Device Support [Disable]	72
<input type="checkbox"/>	SVM Mode [Enabled]	73
<input type="checkbox"/>	Core Leveling Mode [Automatic mode]	73
<input type="checkbox"/>	OnChip SATA Channel [Enabled]	74
<input type="checkbox"/>	OnChip SATA Type [IDE]	74
<input type="checkbox"/>	USB Devices	75
<input type="checkbox"/>	Legacy USB Support [Enabled]	75
<input type="checkbox"/>	Serial Port [Enabled]	77
<input type="checkbox"/>	Change Settings [Auto]	77
<input type="checkbox"/>	Serial Port [Enabled]	78
<input type="checkbox"/>	Change Settings [Auto]	78
<input type="checkbox"/>	Serial Port [Enabled]	79
<input type="checkbox"/>	Change Settings [Auto]	79
<input type="checkbox"/>	Serial Port [Enabled]	80
<input type="checkbox"/>	Change Settings [Auto]	80
<input type="checkbox"/>	Serial Port [Enabled]	80
<input type="checkbox"/>	Change Settings [Auto]	81
<input type="checkbox"/>	PC Health Status	82
<input type="checkbox"/>	Smart Fan Function [Enabled]	82
<input type="checkbox"/>	FAN1 Smart Fan Control [Auto Duty-Cycle Mode]	83
<input type="checkbox"/>	CPU Temperature n	84
<input type="checkbox"/>	FAN2 Smart Fan Control [Auto Duty-Cycle Mode]	84
<input type="checkbox"/>	SYS Temperature n	84
<input type="checkbox"/>	Console Redirection [Disabled]	85
<input type="checkbox"/>	Terminal Type [ANSI]	86
<input type="checkbox"/>	Bits per second [115200]	86
<input type="checkbox"/>	Data Bits [8]	87
<input type="checkbox"/>	Parity [None]	87
<input type="checkbox"/>	Stop Bits [1]	87

KINO-KBN-i2

<input type="checkbox"/>	UMA Frame Buffer Size [256M].....	89
<input type="checkbox"/>	HD Audio Azalia Device [Enabled].....	90
<input type="checkbox"/>	Azalia Front Panel [Enabled]	90
<input type="checkbox"/>	Power Saving Function(ERP) [Disabled].....	91
<input type="checkbox"/>	Bootup NumLock State [On].....	92
<input type="checkbox"/>	Quiet Boot [Enabled]	93
<input type="checkbox"/>	Launch PXE OpROM [Disabled].....	93
<input type="checkbox"/>	Option ROM Messages [Force BIOS].....	93
<input type="checkbox"/>	UEFI Boot [Disabled]	93
<input type="checkbox"/>	Boot Option Priority.....	94
<input type="checkbox"/>	Administrator Password	94
<input type="checkbox"/>	User Password	94
<input type="checkbox"/>	Save Changes and Reset	95
<input type="checkbox"/>	Discard Changes and Reset	95
<input type="checkbox"/>	Restore Defaults	95
<input type="checkbox"/>	Save as User Defaults	95
<input type="checkbox"/>	Restore User Defaults	95

Appendix

D

Digital I/O Interface

KINO-KBN-i2

The DIO connector on the KINO-KBN-i2 is interfaced to GPIO ports on the Super I/O chipset. The digital inputs and digital outputs are generally control signals that control the on/off circuit of external devices or TTL devices. Data can be read or written to the selected address to enable the DIO functions.

**NOTE:**

For further information, please refer to the datasheet for the Super I/O chipset.

The BIOS interrupt call **INT 15H** controls the digital I/O.

INT 15H:

AH – 6FH	
<u>Sub-function:</u>	
AL – 8	: Set the digital port as INPUT
AL	: Digital I/O input value

Assembly Language Sample 1

```
MOV    AX, 6F08H    ; setting the digital port as input
INT    15H          ;
```

AL low byte = value

AH – 6FH	
<u>Sub-function:</u>	
AL – 9	: Set the digital port as OUTPUT
BL	: Digital I/O output value

Assembly Language Sample 2

```
MOV    AX, 6F09H      ; setting the digital port as output
MOV    BL, 09H        ; digital value is 09H
INT    15H           ;
```

Digital Output is 1001b

Appendix

E

Watchdog Timer

**NOTE:**

The following discussion applies to DOS environment. IEI support is contacted or the IEI website visited for specific drivers for more sophisticated operating systems, e.g., Windows and Linux.

The Watchdog Timer is provided to ensure that standalone systems can always recover from catastrophic conditions that cause the CPU to crash. This condition may have occurred by external EMI or a software bug. When the CPU stops working correctly, Watchdog Timer either performs a hardware reset (cold boot) or a Non-Maskable Interrupt (NMI) to bring the system back to a known state.

A BIOS function call (INT 15H) is used to control the Watchdog Timer:

INT 15H:

AH – 6FH Sub-function:	
AL – 2:	Sets the Watchdog Timer's period.
BL:	Time-out value (Its unit-second is dependent on the item "Watchdog Timer unit select" in CMOS setup).

Table E-1: AH-6FH Sub-function

Call sub-function 2 to set the time-out period of Watchdog Timer first. If the time-out value is not zero, the Watchdog Timer starts counting down. While the timer value reaches zero, the system resets. To ensure that this reset condition does not occur, calling sub-function 2 must periodically refresh the Watchdog Timer. However, the Watchdog timer is disabled if the time-out value is set to zero.

A tolerance of at least 10% must be maintained to avoid unknown routines within the operating system (DOS), such as disk I/O that can be very time-consuming.

**NOTE:**

When exiting a program it is necessary to disable the Watchdog Timer, otherwise the system resets.

Example program:

```

; INITIAL TIMER PERIOD COUNTER
;
W_LOOP:

    MOV     AX, 6F02H    ;setting the time-out value
    MOV     BL, 30H     ;time-out value is 48 seconds
    INT     15H

;
; ADD THE APPLICATION PROGRAM HERE
;
    CMP     EXIT_AP, 1  ;is the application over?
    JNE     W_LOOP     ;No, restart the application

    MOV     AX, 6F02H   ;disable Watchdog Timer
    MOV     BL, 0      ;
    INT     15H

;
; EXIT ;

```

Appendix

F

Error Beep Code

F.1 PEI Beep Codes

Number of Beeps	Description
1	Memory not Installed
1	Memory was installed twice (InstallPeiMemory routine in PEI Core called twice)
2	Recovery started
3	DXE IPL was not found
3	DXE Core Firmware Volume was not found
4	Recovery failed
4	S3 Resume failed
7	Reset PPI is not available

F.2 DXE Beep Codes

Number of Beeps	Description
1	Invalid password
4	Some of the Architectural Protocols are not available
5	No Console Output Devices are found
5	No Console Input Devices are found
6	Flash update is failed
7	Reset protocol is not available
8	Platform PCI resource requirements cannot be met



NOTE:

If you have any question, please contact IEI for further assistance.

Appendix

G

Hazardous Materials Disclosure

KINO-KBN-i2

G.1 RoHS II Directive (2015/863/EU)

The details provided in this appendix are to ensure that the product is compliant with the RoHS II Directive (2015/863/EU). The table below acknowledges the presences of small quantities of certain substances in the product, and is applicable to RoHS II Directive (2015/863/EU).

Please refer to the following table.

Part Name	Toxic or Hazardous Substances and Elements									
	Lead (Pb)	Mercury (Hg)	Cadmium (Cd)	Hexavalent Chromium (CR(VI))	Polybrominated Biphenyls (PBB)	Polybrominated Diphenyl Ethers (PBDE)	Bis(2-ethylhexyl) phthalate (DEHP)	Butyl benzyl phthalate (BBP)	Dibutyl phthalate (DBP)	Diisobutyl phthalate (DIBP)
Housing	O	O	O	O	O	O	O	O	O	O
Display	O	O	O	O	O	O	O	O	O	O
Printed Circuit Board	O	O	O	O	O	O	O	O	O	O
Metal Fasteners	O	O	O	O	O	O	O	O	O	O
Cable Assembly	O	O	O	O	O	O	O	O	O	O
Fan Assembly	O	O	O	O	O	O	O	O	O	O
Power Supply Assemblies	O	O	O	O	O	O	O	O	O	O
Battery	O	O	O	O	O	O	O	O	O	O

O: This toxic or hazardous substance is contained in all of the homogeneous materials for the part is below the limit requirement in Directive (EU) 2015/863.

X: This toxic or hazardous substance is contained in at least one of the homogeneous materials for this part is above the limit requirement in Directive (EU) 2015/863.

G.2 China RoHS

此附件旨在确保本产品符合中国 RoHS 标准。以下表格标示此产品中某有毒物质的含量符合中国 RoHS 标准规定的限量要求。

本产品上会附有“环境友好使用期限”的标签，此期限是估算这些物质“不会有泄漏或突变”的年限。本产品可能包含有较短的环境友好使用期限的可替换元件，像是电池或灯管，这些元件将会单独标示出来。

部件名称	有毒有害物质或元素					
	铅 (Pb)	汞 (Hg)	镉 (Cd)	六价铬 (CR(VI))	多溴联苯 (PBB)	多溴二苯醚 (PBDE)
壳体	○	○	○	○	○	○
显示	○	○	○	○	○	○
印刷电路板	○	○	○	○	○	○
金属螺帽	○	○	○	○	○	○
电缆组装	○	○	○	○	○	○
风扇组装	○	○	○	○	○	○
电力供应组装	○	○	○	○	○	○
电池	○	○	○	○	○	○
<p>○: 表示该有毒有害物质在该部件所有物质材料中的含量均在 SJ/T11364-2014 與 GB/T26572-2011 标准规定的限量要求以下。</p> <p>X: 表示该有毒有害物质至少在该部件的某一均质材料中的含量超出 SJ/T11364-2014 與 GB/T26572-2011 标准规定的限量要求。</p>						