



**MODEL:
ICE-BDE-T7**

COM Express R3.0 Module (Type 7) with Intel® Xeon® Processor D-1548/D-1518/D-1508, Two ECC DDR4 SO-DIMM, GbE, 10G KR, NCSI, SATA 6Gb/s, PCIe Gen3 and RoHS

User Manual

Revision

Date	Version	Changes
January 30, 2019	1.01	Added a new SKU - ICE-BDE-T7-1508
December 13, 2017	1.00	Initial release

Copyright

COPYRIGHT NOTICE

The information in this document is subject to change without prior notice in order to improve reliability, design and function and does not represent a commitment on the part of the manufacturer.

In no event will the manufacturer be liable for direct, indirect, special, incidental, or consequential damages arising out of the use or inability to use the product or documentation, even if advised of the possibility of such damages.

This document contains proprietary information protected by copyright. All rights are reserved. No part of this manual may be reproduced by any mechanical, electronic, or other means in any form without prior written permission of the manufacturer.

TRADEMARKS

All registered trademarks and product names mentioned herein are used for identification purposes only and may be trademarks and/or registered trademarks of their respective owners.

Manual Conventions



WARNING

Warnings appear where overlooked details may cause damage to the equipment or result in personal injury. Warnings should be taken seriously.



CAUTION

Cautionary messages should be heeded to help reduce the chance of losing data or damaging the product.



NOTE

These messages inform the reader of essential but non-critical information. These messages should be read carefully as any directions or instructions contained therein can help avoid making mistakes.

Table of Contents

1 INTRODUCTION.....	1
1.1 INTRODUCTION.....	2
1.2 MODEL VARIATIONS	3
1.3 FEATURES.....	3
1.4 BOARD OVERVIEW	4
1.5 DIMENSIONS.....	5
1.6 DATA FLOW	6
1.7 TECHNICAL SPECIFICATIONS	7
2 PACKING LIST.....	9
2.1 ANTI-STATIC PRECAUTIONS	10
2.2 UNPACKING PRECAUTIONS.....	10
2.3 PACKING LIST.....	11
2.4 OPTIONAL ITEMS	12
3 CONNECTORS	13
3.1 PERIPHERAL INTERFACE CONNECTORS.....	14
3.1.1 ICE-BDE-T7 Layout	14
3.1.2 Peripheral Interface Connectors	15
3.2 INTERNAL PERIPHERAL CONNECTORS	15
3.2.1 COM Express A-B Connector	15
3.2.2 COM Express C-D Connector	19
3.2.3 CPLD Programming Connector	24
3.2.4 DDR4 SO-DIMM Connectors.....	25
3.2.5 Debug Port, LPC	26
3.2.6 Debug Port, EC.....	27
3.2.7 SPI Flash Connector, BIOS.....	28
3.2.8 SPI Flash Connector, EC	29
4 INSTALLATION	30
4.1 ANTI-STATIC PRECAUTIONS	31

4.2	INSTALLATION CONSIDERATIONS.....	31
4.3	SO-DIMM INSTALLATION	33
4.4	MOUNTING ICE-BDE-T7 TO BASEBOARD	34
5	BIOS	36
5.1	INTRODUCTION.....	37
5.1.1	<i>Starting Setup</i>	37
5.1.2	<i>Using Setup</i>	37
5.1.3	<i>Getting Help</i>	38
5.1.4	<i>Unable to Reboot after Configuration Changes</i>	38
5.1.5	<i>BIOS Menu Bar</i>	38
5.2	MAIN.....	39
5.3	ADVANCED	39
5.3.1	<i>Trusted Computing</i>	41
5.3.2	<i>iWDD H/W Monitor</i>	42
5.3.2.1	<i>Smart Fan Mode Configuration</i>	43
5.3.3	<i>iWDD Super IO Configuration</i>	45
5.3.3.1	<i>Serial Port n Configuration</i>	46
5.3.4	<i>RTC Wake Settings</i>	48
5.3.5	<i>Serial Port Console Redirection</i>	49
5.3.5.1	<i>Legacy Console Redirection Settings</i>	50
5.3.5.2	<i>Console Redirection Settings</i>	51
5.3.6	<i>USB Configuration</i>	53
5.3.7	<i>IEI Feature</i>	54
5.4	INTELRCS SETUP	55
5.4.1	<i>Processor Configuration</i>	56
5.4.2	<i>IIO Configuration</i>	58
5.4.2.1	<i>IIO0 Configuration</i>	58
5.4.2.2	<i>Intel VT for Directed I/O (VT-d)</i>	59
5.4.2.3	<i>IIO South Complex Configuration</i>	60
5.4.3	<i>PCH Configuration</i>	61
5.4.3.1	<i>PCI Express Configuration</i>	61
5.4.3.2	<i>PCH SATA Configuration</i>	62
5.5	SERVER MANAGEMENT	64
5.5.1	<i>System Event Log</i>	64

ICE-BDE-T7 COM Express Module

5.6 SECURITY.....	66
5.7 BOOT.....	67
5.8 SAVE & EXIT	69
6 SOFTWARE DRIVERS	71
6.1 AVAILABLE DRIVERS	72
6.2 DRIVER DOWNLOAD	72
A REGULATORY COMPLIANCE	74
B PRODUCT DISPOSAL	76
C BIOS OPTIONS	78
D DIGITAL I/O INTERFACE.....	81
E WATCHDOG TIMER.....	84
F HAZARDOUS MATERIALS DISCLOSURE.....	87

List of Figures

Figure 1-1: ICE-BDE-T7	2
Figure 1-2: On-board Components and Connectors	4
Figure 1-3: ICE-BDE-T7 Dimensions (without heatsink) (mm).....	5
Figure 1-4: ICE-BDE-T7 Dimensions (with heatsink) (mm)	5
Figure 1-5: Data Flow Diagram.....	6
Figure 3-1: Connectors (Front Side).....	14
Figure 3-2: Connectors (Solder Side).....	14
Figure 3-3: COM Express A-B Connector Location	16
Figure 3-4: COM Express C-D Connector Location	20
Figure 3-5: CPLD Programming Connector Location.....	24
Figure 3-6: SO-DIMM Connector Locations	25
Figure 3-7: LPC Debug Port Location.....	26
Figure 3-8: EC Debug Port Location.....	27
Figure 3-9: BIOS SPI Flash Connector Location	28
Figure 3-10: EC SPI Flash Connector Location.....	29
Figure 4-1: SO-DIMM Installation	33
Figure 4-2: Connect the COM Express Connectors.....	35
Figure 4-3: Secure the Heatsink.....	35
Figure 6-1: IEI Resource Download Center.....	72

List of Tables

Table 1-1: Model Variations	3
Table 1-2: ICE-BDE-T7 Specifications	8
Table 2-1: Packing List.....	11
Table 2-2: Optional Items	12
Table 3-1: Peripheral Interface Connectors	15
Table 3-2: COM Express A-B Connector Pin Definitions.....	19
Table 3-3: COM Express C-D Connector Pin Definitions.....	23
Table 3-4: CPLD Programming Connector Pin Definitions	24
Table 3-5: LPC Debug Port Pin Definitions	26
Table 3-6: EC Debug Port Pin Definitions	27
Table 3-7: BIOS SPI Flash Connector Pin Definitions	28
Table 3-8: EC SPI Flash Connector Pin Definitions	29

BIOS Menus

BIOS Menu 1: Main	39
BIOS Menu 2: Advanced	40
BIOS Menu 3: Trusted Computing	41
BIOS Menu 4: iWDD H/W Monitor	42
BIOS Menu 5: Smart Fan Mode Configuration	43
BIOS Menu 6: iWDD Super IO Configuration	45
BIOS Menu 7: Serial Port n Configuration	46
BIOS Menu 8: RTC Wake Settings	48
BIOS Menu 9: Serial Port Console Redirection	49
BIOS Menu 10: Legacy Console Redirection Settings	50
BIOS Menu 11: Console Redirection Settings	51
BIOS Menu 12: USB Configuration	53
BIOS Menu 13: IEI Feature	54
BIOS Menu 14: IntelRCSetup	55
BIOS Menu 15: Processor Configuration	56
BIOS Menu 16: IIO Configuration	58
BIOS Menu 17: IIO0 Configuration	58
BIOS Menu 18: Intel VT for Directed I/O (VT-d)	59
BIOS Menu 19: IIO South Complex Configuration	60
BIOS Menu 20: PCH Configuration	61
BIOS Menu 21: PCI Express Configuration	61
BIOS Menu 22: PCH SATA Configuration	62
BIOS Menu 23: Server Management	64
BIOS Menu 24: System Event Log	65
BIOS Menu 25: Security	66
BIOS Menu 26: Boot	67
BIOS Menu 27: Save & Exit	69

Chapter

1

Introduction

1.1 Introduction



Figure 1-1: ICE-BDE-T7

The ICE-BDE-T7 COM Express Type 7 module provides the main processing chips and is connected to a compatible COM Express baseboard. The ICE-BDE-T7 is preinstalled with Intel® Xeon® D-1548, D-1518 or D-1508 processor. The COM Express standard allows the COM Express baseboard to be designed, while leaving the choice of processor till the later stages of design. The ICE-BDE-T7 provides a low power option with the full range of modern I/O options. The ICE-BDE-T7 embedded module is designed for flexible integration by system developers into customized platform devices.

ICE-BDE-T7 COM Express Module

1.2 Model Variations

The model variations for the ICE-BDE-T7 series are listed in **Table 1-1**.

Model	On-board SoC				
	Name	Clock Speed	# of Cores	L2 Cache	Max TDP
ICE-BDE-T7-1548	Intel® Xeon® D-1548	2.0 GHz	8	12 MB	45 W
ICE-BDE-T7-1518	Intel® Xeon® D-1518	2.2 GHz	4	6 MB	35 W
ICE-BDE-T7-1508	Intel® Xeon® D-1508	2.2 GHz	2	3 MB	25 W

Table 1-1: Model Variations

1.3 Features

Some of the ICE-BDE-T7 COM Express module features are listed below:

- Complies with COM Express Type 7 form factor
- On-board Intel® Xeon® D-1548, D-1518 or D-1508 processor
- Two 260-pin 2133/1867 MHz dual-channel unbuffered DDR4 SDRAM
SO-DIMM slots support up to a total of 32 GB of memory and ECC memory
- Two 10G Ethernet and NC-SI support
- Up to 32 PCIe lanes (24 x Gen3, 8 x Gen2)
- GbE, two SATA 6 Gb/s, four USB 3.0/2.0
- RoHS compliant

1.4 Board Overview

The on-board components and connectors of the ICE-BDE-T7 are shown in the figures below.

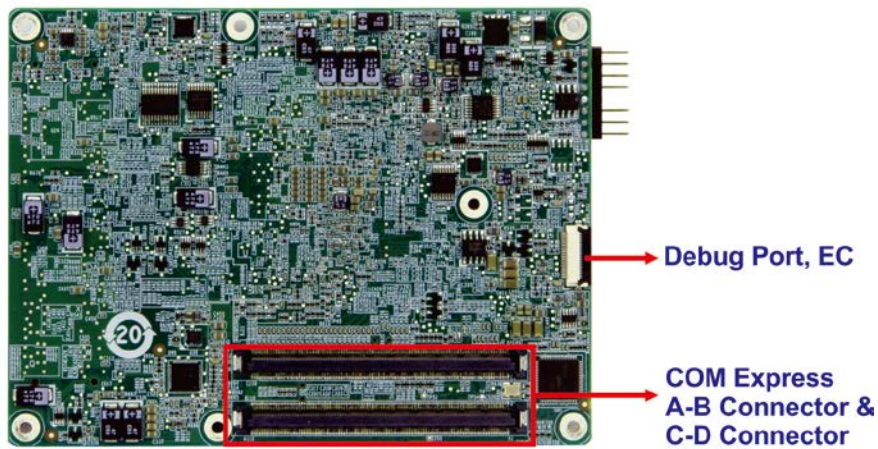
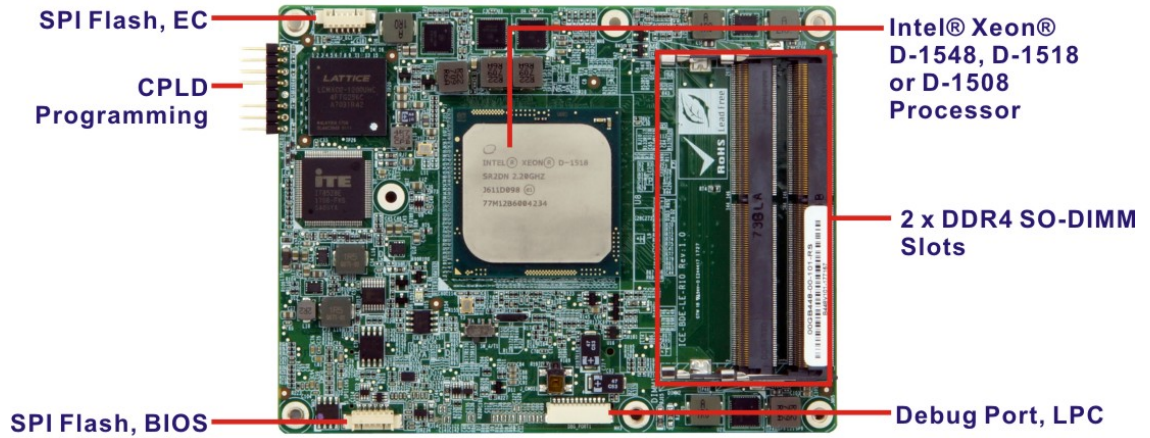

Figure 1-2: On-board Components and Connectors

ICE-BDE-T7 COM Express Module

1.5 Dimensions

The main dimensions of the ICE-BDE-T7 are shown in the diagrams below.

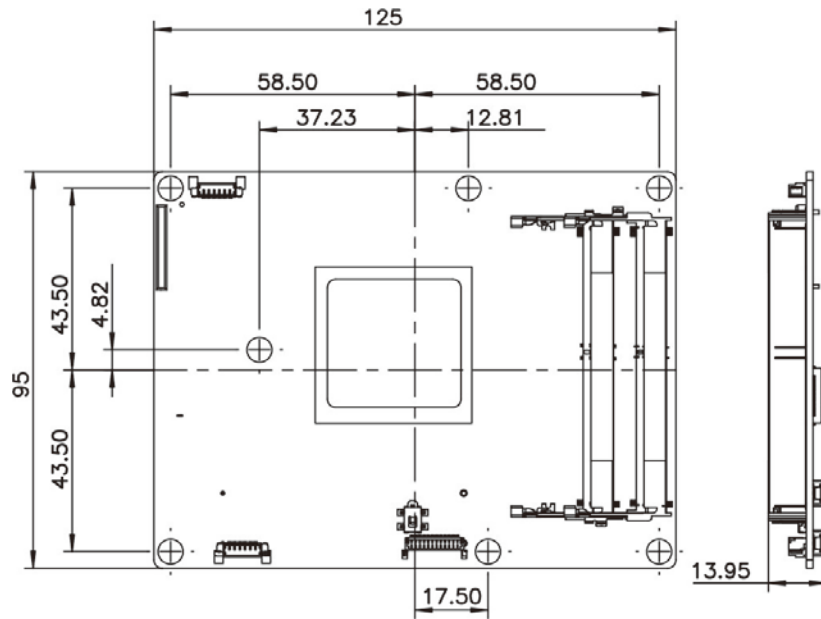

Figure 1-3: ICE-BDE-T7 Dimensions (without heatsink) (mm)

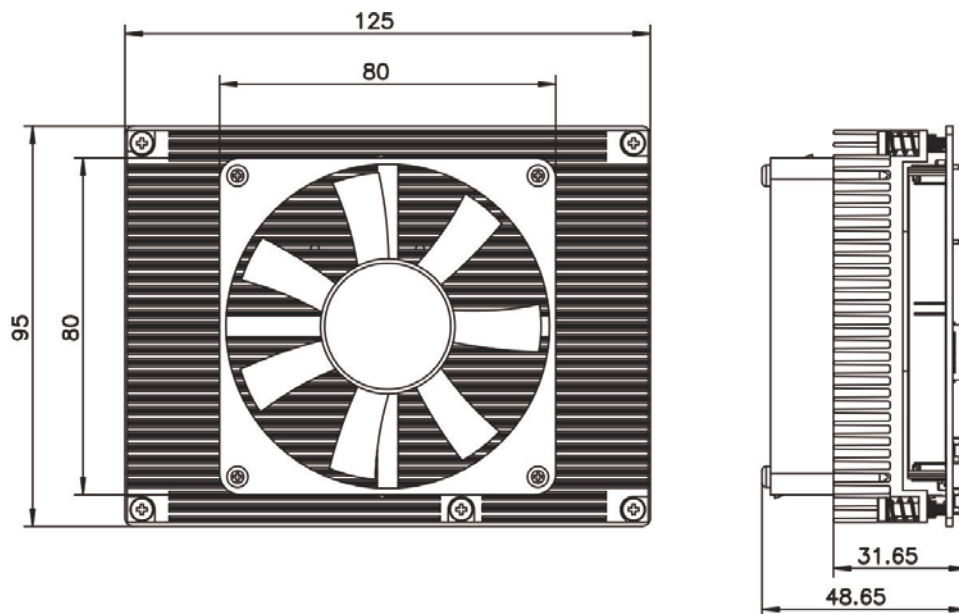

Figure 1-4: ICE-BDE-T7 Dimensions (with heatsink) (mm)

1.6 Data Flow

Figure 1-5 shows the data flow between the system chipset, the CPU and other components installed on the motherboard.

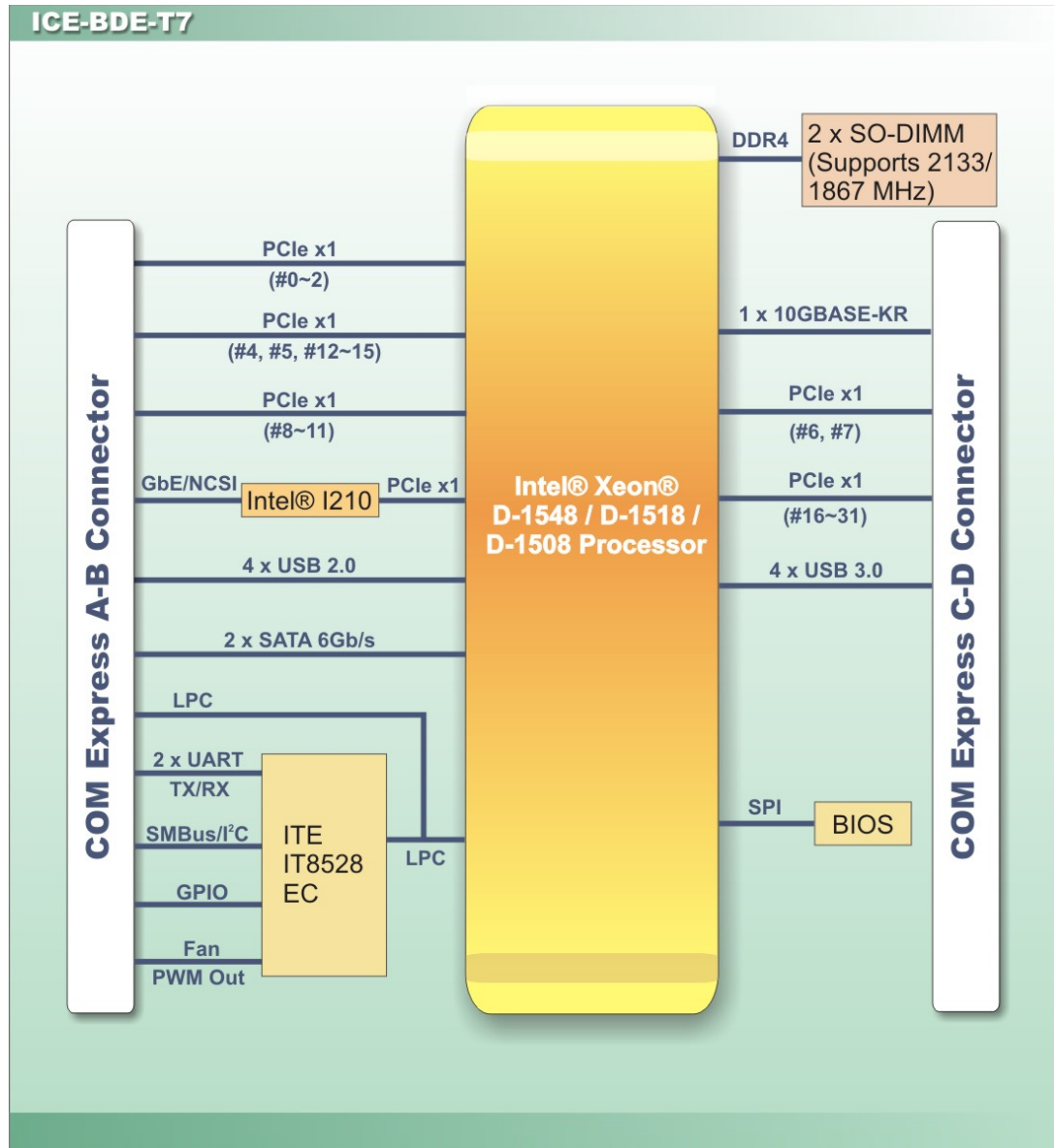

Figure 1-5: Data Flow Diagram

ICE-BDE-T7 COM Express Module

1.7 Technical Specifications

The ICE-BDE-T7 technical specifications are listed below.

	ICE-BDE-T7
Form Factor	PICMG COM Express R3.0 Type 7
Processor	Intel® Xeon® processor D-1548 (12 MB Cache, 2.00 GHz) Intel® Xeon® processor D-1518 (6 MB Cache, 2.20 GHz) Intel® Xeon® Processor D-1508 (3 MB Cache, 2.20 GHz)
Memory	Two 260-pin 2133/1867 MHz dual-channel unbuffered DDR4 SDRAM SO-DIMM slots support up to a total of 32 GB of memory Support ECC
BIOS	UEFI BIOS
Watchdog Timer	Software programmable supports 1~255 sec. system reset
Ethernet	Intel® I210 Ethernet controller 10G Sideband Signals (10G_INT, 10G_PHY_MDC/MDIO, 10G_PHY_SEL, 10G_PHY_RST, 10G_LED_I2C, 10G_SFP_I2C, 10G_SDP)
Storage	Two SATA 6Gb/s (signal to baseboard)
Expansions (Signal to Baseboard)	1 x PCIe x16 Gen 3 (Bifurcatable to 2 x8, 1 x8 & 2 x4, or 4 x4) 1 x PCIe x8 Gen 3 (Bifurcatable to 1 x8 & 2 x4) 8 x PCIe x1 Gen 2 (Bifurcatable to 1 x8 or 2 x4 or 4 x1+1x4 or 8 x1)
I/O Interfaces (Signal to Baseboard)	4 x USB 2.0 4 x USB 3.0 2 x RS-232 (2-wire) 8-bit GPIO SMBus I ² C LPC TPM
Power Supply	12V: 12VSB±5%

	ICE-BDE-T7
Operating Temperature	-20°C ~ 60°C, with 0.7m/s air flow
Storage Temperature	-30°C ~ 70°C
Operating Humidity	5% ~ 95% (non-condensing)
Dimensions	125 mm x 95 mm
Weight (GW/NW)	600 g / 300 g

Table 1-2: ICE-BDE-T7 Specifications

Chapter

2

Packing List

2.1 Anti-static Precautions



WARNING!

Static electricity can destroy certain electronics. Make sure to follow the ESD precautions to prevent damage to the product, and injury to the user.

Make sure to adhere to the following guidelines:

- **Wear an anti-static wristband:** Wearing an anti-static wristband can prevent electrostatic discharge.
- **Self-grounding:** Touch a grounded conductor every few minutes to discharge any excess static buildup.
- **Use an anti-static pad:** When configuring any circuit board, place it on an anti-static mat.
- **Only handle the edges of the PCB:** Don't touch the surface of the motherboard. Hold the motherboard by the edges when handling.

2.2 Unpacking Precautions

When the ICE-BDE-T7 is unpacked, please do the following:

- Follow the antistatic guidelines above.
- Make sure the packing box is facing upwards when opening.
- Make sure all the packing list items are present.

ICE-BDE-T7 COM Express Module

2.3 Packing List



NOTE:

If any of the components listed in the checklist below are missing, do not proceed with the installation. Contact the IEI reseller or vendor the ICE-BDE-T7 was purchased from or contact an IEI sales representative directly by sending an email to sales@ieiworld.com.

The ICE-BDE-T7 is shipped with the following components:



Quantity	Item and Part Number	Image
1	ICE-BDE-T7 COM Express Module	
1	Heatsink	
1	Quick Installation Guide	

Table 2-1: Packing List

2.4 Optional Items

The following are optional components which may be separately purchased:

Item and Part Number	Image
Baseboard for COM Express Type 7 modules (P/N: ICE-DB-T7-i2-R10)	

Table 2-2: Optional Items

Chapter

3

Connectors

3.1 Peripheral Interface Connectors

This chapter details all the connectors.

3.1.1 ICE-BDE-T7 Layout

The figures below show all the connectors on the front side and the solder side.

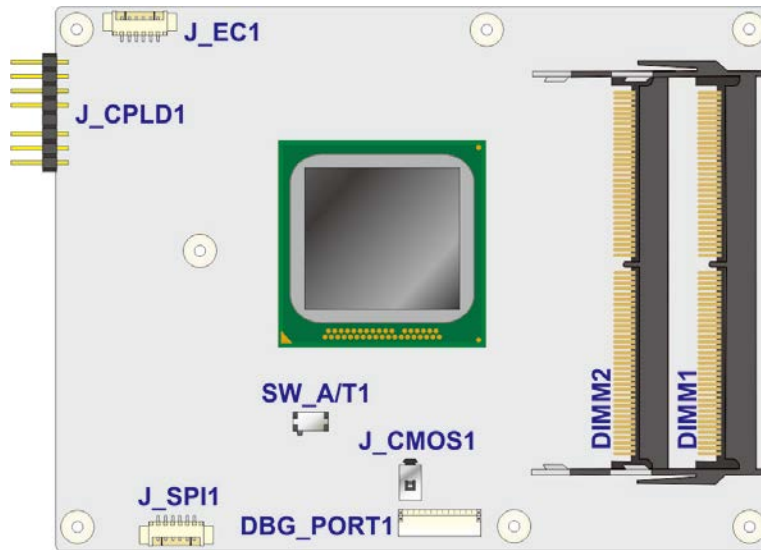

Figure 3-1: Connectors (Front Side)



Figure 3-2: Connectors (Solder Side)

ICE-BDE-T7 COM Express Module

3.1.2 Peripheral Interface Connectors

The table below lists all the connectors on the ICE-BDE-T7.

Connector	Type	Label
COM Express A-B connector	COM Express connector	J1
COM Express C-D connector	COM Express connector	J2
Clear CMOS button	Push button	J_CMOS
CPLD programming connector	8-pin header	J_CPLD1
DDR4 SO-DIMM slot	260-pin SO-DIMM slot	DIMM1, DIMM2
Debug port, LPC	12-pin wafer	DBG_PORT1
Debug port, EC	20-pin FPC	DBG_EC1
SPI flash connector, BIOS	6-pin wafer	J_SPI1
SPI flash connector, EC	6-pin wafer	J_EC1

Table 3-1: Peripheral Interface Connectors

3.2 Internal Peripheral Connectors

The section describes all of the connectors on the ICE-BDE-T7.

3.2.1 COM Express A-B Connector

- CN Label:** J1
- CN Type:** 220-pin COM Express connector
- CN Location:** See **Figure 3-3**
- CN Pinouts:** See **Table 3-2**

The standard COM Express A-B connector location and pinouts are shown below.

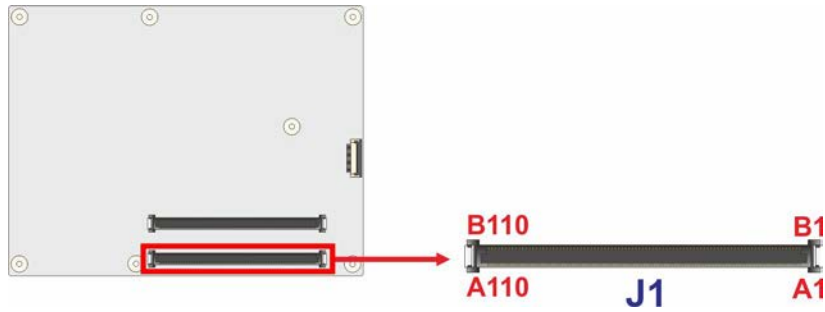

Figure 3-3: COM Express A-B Connector Location

Pin No.	Description	Pin No.	Description
A1	GND	B1	GND
A2	GBE0_MDI3-	B2	GBE0_ACT#
A3	GBE0_MDI3+	B3	LPC_FRAME#
A4	GBE0_LINK100#	B4	LPC_AD0
A5	GBE0_LINK1000#	B5	LPC_AD1
A6	GBE0_MDI2-	B6	LPC_AD2
A7	GBE0_MDI2+	B7	LPC_AD3
A8	NC	B8	LPC_DRQ#0
A9	GBE0_MDI1-	B9	NC
A10	GBE0_MDI1+	B10	LPC_CLK
A11	GND	B11	GND
A12	GBE0_MDI0-	B12	PWRBTN#
A13	GBE0_MDI0+	B13	SMB_CK
A14	NC	B14	SMB_DATA
A15	PM_SLP_S3#	B15	SMB_ALERT#
A16	SATA0_TX+	B16	SATA1_TX+
A17	SATA0_TX-	B17	SATA1_TX-
A18	PM_SLP_S4#	B18	LPCPD_N
A19	SATA0_RX+	B19	SATA1_RX+
A20	SATA0_RX-	B20	SATA1_RX-
A21	GND	B21	GND
A22	PE2_TX_DP_7	B22	PE2_RX_DP_7
A23	PE2_TX_DN_#7	B23	PE2_RX_DN_#7
A24	PM_SLP_S5#	B24	PWR_OK

ICE-BDE-T7 COM Express Module

Pin No.	Description	Pin No.	Description
A25	PE2_TX_DP_6	B25	PE2_RX_DP_6
A26	PE2_TX_DN_#6	B26	PE2_RX_DN_#6
A27	NC	B27	WDTRST#
A28	SATA_LED#	B28	NC
A29	NC	B29	NC
A30	NC	B30	NC
A31	GND	B31	GND
A32	NC	B32	SPKR
A33	NC	B33	I2C_CLK
A34	BIOS_DISABLE#	B34	I2C_DAT
A35	NC	B35	NC
A36	PE2_TX_DP_5	B36	PE2_RX_DP_5
A37	PE2_TX_DN_#5	B37	PE2_RX_DN_#5
A38	GND	B38	GND
A39	PE2_TX_DP_4	B39	PE2_RX_DP_4
A40	PE2_TX_DN_#4	B40	PE2_RX_DN_#4
A41	GND	B41	GND
A42	USB2-	B42	USB3-
A43	USB2+	B43	USB3+
A44	USB_2_3_OC#	B44	USB_0_1_OC#
A45	USB0-	B45	USB1-
A46	USB0+	B46	USB1+
A47	+V3.3A_RTC	B47	NC
A48	NC	B48	NC
A49	NC	B49	SYS_RESET#
A50	INT_SERIRQ	B50	CB_RESET#
A51	GND	B51	GND
A52	PCIE_TX_DP_6	B52	PCIE_RX_DP_6
A53	PCIE_TX_DN#_6	B53	PCIE_RX_DN#_6
A54	DINO	B54	DOUT1
A55	PCIE_TX_DP_5	B55	PCIE_RX_DP_5
A56	PCIE_TX_DN#_5	B56	PCIE_RX_DN#_5

Pin No.	Description	Pin No.	Description
A57	GND	B57	DOUT2
A58	PCIE_TX_DP_4	B58	PCIE_RX_DP_4
A59	PCIE_TX_DN#_4	B59	PCIE_RX_DN#_4
A60	GND	B60	GND
A61	PCIE_TX_DP_3	B61	PCIE_RX_DP_3
A62	PCIE_TX_DN#_3	B62	PCIE_RX_DN#_3
A63	DIN1	B63	DOUT3
A64	PCIE_TX_DP_2	B64	PCIE_RX_DP_2
A65	PCIE_TX_DN#_2	B65	PCIE_RX_DN#_2
A66	GND	B66	WAKE0#
A67	DIN2	B67	NC
A68	PCIE_TX_DP_1	B68	PCIE_RX_DP_1
A69	PCIE_TX_DN#_1	B69	PCIE_RX_DN#_1
A70	GND	B70	GND
A71	PE2_TX_DP_0	B71	PE2_RX_DP_0
A72	PE2_TX_DN_#0	B72	PE2_RX_DN_#0
A73	GND	B73	GND
A74	PE2_TX_DP_1	B74	PE2_RX_DP_1
A75	PE2_TX_DN_#1	B75	PE2_RX_DN_#1
A76	GND	B76	GND
A77	PE2_TX_DP_2	B77	PE2_RX_DP_2
A78	PE2_TX_DN_#2	B78	PE2_RX_DN_#2
A79	GND	B79	GND
A80	GND	B80	GND
A81	PE2_TX_DP_3	B81	PE2_RX_DP_3
A82	PE2_TX_DN_#3	B82	PE2_RX_DN_#3
A83	GND	B83	GND
A84	NCSI_TX_EN	B84	+V5A
A85	DIN3	B85	+V5A
A86	NC	B86	+V5A
A87	NC	B87	+V5A
A88	CLK_PCIE_CLK_P	B88	NC

ICE-BDE-T7 COM Express Module

Pin No.	Description	Pin No.	Description
A89	CLK_PCIE_CLK_N	B89	NC
A90	GND	B90	GND
A91	NC	B91	NCSI_CLK
A92	SPI_MISO	B92	NCSI_RXD1
A93	DOU0	B93	NCSI_RXD0
A94	SPI_CLK	B94	NCSI_CRS
A95	SPI_MOSI	B95	NCSI_TXD1
A96	NC	B96	NCSI_TXD0
A97	NC	B97	SPI_CS
A98	RS1_TX	B98	NC
A99	RS1_RX	B99	NC
A100	GND	B100	GND
A101	RS2_TX	B101	FAN_PWMOUT
A102	RS2_RX	B102	FAN_TACHIN
A103	LID#	B103	SLEEP#
A104	VCC_12V	B104	VCC_12V
A105	VCC_12V	B105	VCC_12V
A106	VCC_12V	B106	VCC_12V
A107	VCC_12V	B107	VCC_12V
A108	VCC_12V	B108	VCC_12V
A109	VCC_12V	B109	VCC_12V
A110	GND	B110	GND

Table 3-2: COM Express A-B Connector Pin Definitions

3.2.2 COM Express C-D Connector

- CN Label:** J2
- CN Type:** 220-pin COM Express connector
- CN Location:** See **Figure 3-4**
- CN Pinouts:** See **Table 3-3**

The standard COM Express C-D connector location and pinouts are shown below.

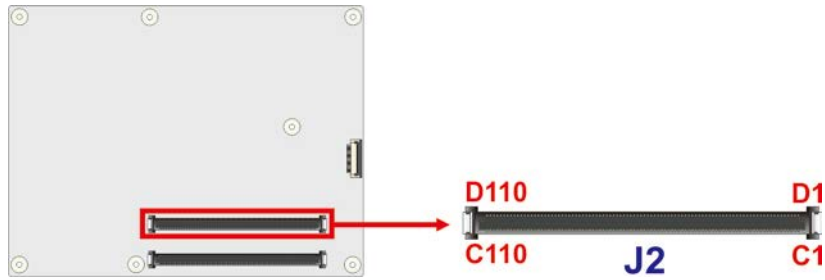

Figure 3-4: COM Express C-D Connector Location

Pin No.	Description	Pin No.	Description
C1	GND	D1	GND
C2	GND	D2	GND
C3	USB3_RXN_0	D3	USB3_TXN_0
C4	USB3_RXP_0	D4	USB3_TXP_0
C5	GND	D5	GND
C6	USB3_RXN_1	D6	USB3_TXN_1
C7	USB3_RXP_1	D7	USB3_TXP_1
C8	GND	D8	GND
C9	USB3_RXN_2	D9	USB3_TXN_2
C10	USB3_RXP_2	D10	USB3_TXP_2
C11	GND	D11	GND
C12	USB3_RXN_3	D12	USB3_TXN_3
C13	USB3_RXP_3	D13	USB3_TXP_3
C14	GND	D14	GND
C15	NC	D15	NC
C16	NC	D16	NC
C17	NC	D17	NC
C18	GND	D18	GND
C19	PCIE_RX_DP_7	D19	PCIE_TX_DP_7
C20	PCIE_RX_DP#_7	D20	PCIE_TX_DP#_7
C21	GND	D21	GND
C22	PCIE_RX_DP_8	D22	PCIE_TX_DP_8
C23	PCIE_RX_DP#_8	D23	PCIE_TX_DP#_8
C24	NC	D24	NC
C25	GND	D25	GND

ICE-BDE-T7 COM Express Module

Pin No.	Description	Pin No.	Description
C26	NC	D26	NC
C27	NC	D27	NC
C28	GND	D28	GND
C29	NC	D29	NC
C30	NC	D30	NC
C31	GND	D31	GND
C32	NC	D32	LAN_FLSH_DI*
C33	NC	D33	LAN_FLSH_CS_N*
C34	NC	D34	NC
C35	NC	D35	NC
C36	LAN_I2C_SDA*	D36	10G_SFP+_Present_N*
C37	LAN_I2C_SCL*	D37	10G_Baset_Present_N*
C38	LAN_MDC1_LED1_1*	D38	LAN_FLSH_CLK*
C39	LAN_MDIO1_LED1_0*	D39	LAN_FLSH_DO*
C40	LAN_SDPO_1*	D40	LAN_SDPO_0*
C41	GND	D41	GND
C42	GBE_KR_RX1_P	D42	GBE_KR_TX1_P
C43	GBE_KR_RX1_N	D43	GBE_KR_TX1_N
C44	GND	D44	GND
C45	LAN_MDC0_LED0_1*	D45	LAN_MDIO_DIR_CTL1
C46	LAN_MDIO0_LED0_0*	D46	LAN_MDIO_DIR_CTL0
C47	LAN_SDP1_1	D47	LAN_SDP1_0
C48	GND	D48	GND
C49	GBE_KR_RX0_P	D49	GBE_KR_TX0_P
C50	GBE_KR_RX0_N	D50	GBE_KR_TX0_N
C51	GND	D51	GND
C52	PE1_RX_DP_0	D52	PE1_TX_DP_0
C53	PE1_RX_DN#_0	D53	PE1_TX_DN#_0
C54	NC	D54	NC
C55	PE1_RX_DP_1	D55	PE1_TX_DP_1
C56	PE1_RX_DN#_1	D56	PE1_TX_DN#_1
C57	NC	D57	NC

Pin No.	Description	Pin No.	Description
C58	PE1_RX_DP_2	D58	PE1_TX_DP_2
C59	PE1_RX_DN#_2	D59	PE1_TX_DN#_2
C60	GND	D60	GND21
C61	PE1_RX_DP_3	D61	PE1_TX_DP_3
C62	PE1_RX_DN#_3	D62	PE1_TX_DN#_3
C63	NC	D63	NC
C64	NC	D64	NC
C65	PE1_RX_DP_4	D65	PE1_TX_DP_4
C66	PE1_RX_DN#_4	D66	PE1_TX_DN#_4
C67	NC	D67	GND
C68	PE1_RX_DP_5	D68	PE1_TX_DP_5
C69	PE1_RX_DN#_5	D69	PE1_TX_DN#_5
C70	GND	D70	GND
C71	PE1_RX_DP_6	D71	PE1_TX_DP_6
C72	PE1_RX_DN#_6	D72	PE1_TX_DN#_6
C73	GND	D73	GND
C74	PE1_RX_DP_7	D74	PE1_TX_DP_7
C75	PE1_RX_DN#_7	D75	PE1_TX_DN#_7
C76	GND	D76	GND
C77	NC	D77	NC
C78	PE1_RX_DP_8	D78	PE1_TX_DP_8
C79	PE1_RX_DN#_8	D79	PE1_TX_DN#_8
C80	GND	D80	GND
C81	PE1_RX_DP_9	D81	PE1_TX_DP_9
C82	PE1_RX_DN#_9	D82	PE1_TX_DN#_9
C83	NC	D83	NC
C84	GND	D84	GND
C85	PE1_RX_DP_10	D85	PE1_TX_DP_10
C86	PE1_RX_DN#_10	D86	PE1_TX_DN#_10
C87	GND	D87	GND
C88	PE1_RX_DP_11	D88	PE1_TX_DP_11
C89	PE1_RX_DN#_11	D89	PE1_TX_DN#_11

ICE-BDE-T7 COM Express Module

Pin No.	Description	Pin No.	Description
C90	GND	D90	GND
C91	PE1_RX_DP_12	D91	PE1_TX_DP_12
C92	PE1_RX_DN#_12	D92	PE1_TX_DN#_12
C93	GND	D93	GND
C94	PE1_RX_DP_13	D94	PE1_TX_DP_13
C95	PE1_RX_DN#_13	D95	PE1_TX_DN#_13
C96	GND	D96	GND
C97	NC	D97	NC
C98	PE1_RX_DP_14	D98	PE1_TX_DP_14
C99	PE1_RX_DN#_14	D99	PE1_TX_DN#_14
C100	GND	D100	GND
C101	PE1_RX_DP_15	D101	PE1_TX_DP_15
C102	PE1_RX_DN#_15	D102	PE1_TX_DN#_15
C103	GND	D103	GND
C104	VCC_12V	D104	VCC_12V
C105	VCC_12V	D105	VCC_12V
C106	VCC_12V	D106	VCC_12V
C107	VCC_12V	D107	VCC_12V
C108	VCC_12V	D108	VCC_12V
C109	VCC_12V	D109	VCC_12V
C110	GND	D110	GND

Table 3-3: COM Express C-D Connector Pin Definitions

3.2.3 CPLD Programming Connector

- CN Label:** J_CPLD1
- CN Type:** 8-pin header, p=2.54 mm
- CN Location:** See **Figure 3-5**
- CN Pinouts:** See **Table 3-4**

The CPLD programming connector location and pinouts are shown below.

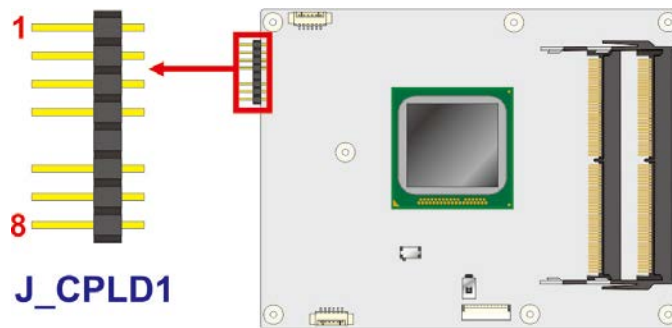

Figure 3-5: CPLD Programming Connector Location

Pin No.	Description
1	VCC3.3SB
2	CPLD_TDO
3	CPLD_TDI
4	NC
5	NC
6	CPLD_TMS
7	GND
8	CPLD_TCK

Table 3-4: CPLD Programming Connector Pin Definitions

ICE-BDE-T7 COM Express Module

3.2.4 DDR4 SO-DIMM Connectors

CN Label:	DIMM1, DIMM2
CN Type:	260-pin DDR4 SO-DIMM connector
CN Location:	See Figure 3-6

The SO-DIMM connectors are for installing DDR4 memory on the system.



NOTE:

For dual channel configuration, always install two identical memory modules that feature the same capacity, timings, voltage, number of ranks and the same brand.

If there is only one memory module being installed, install it in the **DIMM1** slot.

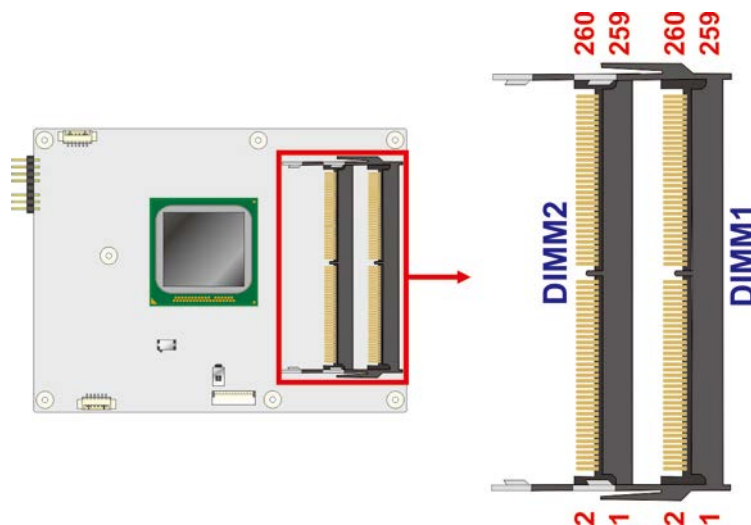

Figure 3-6: SO-DIMM Connector Locations

3.2.5 Debug Port, LPC

- CN Label:** **DBG_PORT1**
- CN Type:** 12-pin wafer, p=1.00 mm
- CN Location:** See **Figure 3-7**
- CN Pinouts:** See **Table 3-5**

The LPC debug port location and pinouts are shown below.

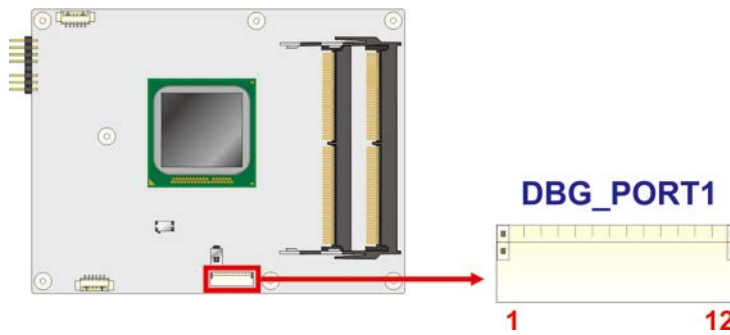

Figure 3-7: LPC Debug Port Location

Pin No.	Description
1	NC
2	LPC_CLK_REF
3	SYS_RESET#
4	LPC_FRAME#
5	LPC_ADO
6	LPC_AD1
7	LPC_AD2
8	LPC_AD3
9	INT_SERIRQ
10	GND
11	VCC3
12	NC

Table 3-5: LPC Debug Port Pin Definitions

ICE-BDE-T7 COM Express Module

3.2.6 Debug Port, EC

- CN Label:** **DBG_EC1**
- CN Type:** 20-pin FPC, p=0.5 mm
- CN Location:** See **Figure 3-8**
- CN Pinouts:** See **Table 3-6**

The EC debug port location and pinouts are shown below.

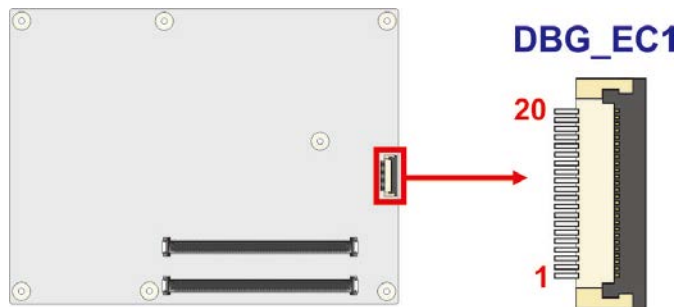

Figure 3-8: EC Debug Port Location

Pin No.	Description	Pin No.	Description
1	KSI0	11	KSO9
2	KSO0	12	KSO10
3	KSO1	13	KSO12
4	KSO2	14	KSI1
5	KSO3	15	KSO11
6	KSO4	16	KSI2
7	KSO5	17	KSI3
8	KSO6	18	GND
9	KSO7	19	GND
10	KSO8	20	GND

Table 3-6: EC Debug Port Pin Definitions

3.2.7 SPI Flash Connector, BIOS

- CN Label:** J_SPI1
- CN Type:** 6-pin wafer, p=1.25 mm
- CN Location:** See **Figure 3-9**
- CN Pinouts:** See **Table 3-7**

The BIOS SPI flash connector location and pinouts are shown below.

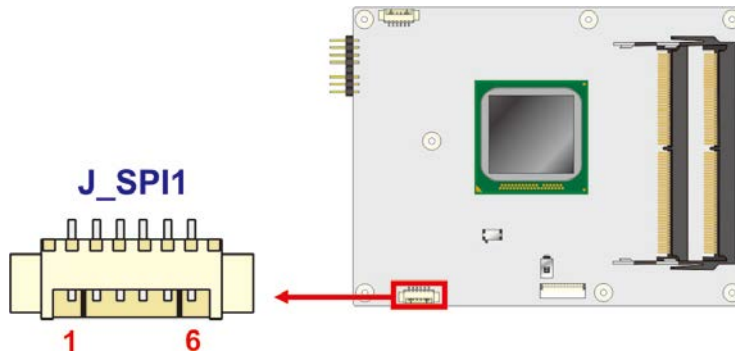

Figure 3-9: BIOS SPI Flash Connector Location

Pin No.	Description
1	VCC1.8V
2	CS
3	MISO
4	CLK
5	MOSI
6	GND

Table 3-7: BIOS SPI Flash Connector Pin Definitions

ICE-BDE-T7 COM Express Module

3.2.8 SPI Flash Connector, EC

- CN Label:** J_EC1
- CN Type:** 6-pin wafer, p=1.25 mm
- CN Location:** See **Figure 3-10**
- CN Pinouts:** See **Table 3-8**

The EC SPI flash connector location and pinouts are shown below.

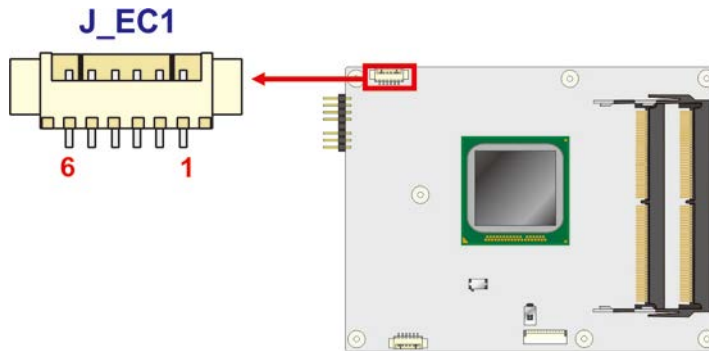

Figure 3-10: EC SPI Flash Connector Location

Pin No.	Description
1	VCC3.3V
2	CS
3	MISO
4	CLK
5	MOSI
6	GND

Table 3-8: EC SPI Flash Connector Pin Definitions

Chapter

4

Installation

ICE-BDE-T7 COM Express Module

4.1 Anti-static Precautions



WARNING:

Failure to take ESD precautions during the installation of the ICE-BDE-T7 may result in permanent damage to the ICE-BDE-T7 and severe injury to the user.

Electrostatic discharge (ESD) can cause serious damage to electronic components, including the ICE-BDE-T7. Dry climates are especially susceptible to ESD. It is therefore critical that whenever the ICE-BDE-T7 or any other electrical component is handled, the following anti-static precautions are strictly adhered to.

- **Wear an anti-static wristband:** Wearing a simple anti-static wristband can help to prevent ESD from damaging the board.
- **Self-grounding:** Before handling the board, touch any grounded conducting material. During the time the board is handled, frequently touch any conducting materials that are connected to the ground.
- **Use an anti-static pad:** When configuring the ICE-BDE-T7, place it on an anti-static pad. This reduces the possibility of ESD damaging the ICE-BDE-T7.
- **Only handle the edges of the PCB:** When handling the PCB, hold the PCB by the edges.

4.2 Installation Considerations



NOTE:

The following installation notices and installation considerations should be read and understood before installation. All installation notices must be strictly adhered to. Failing to adhere to these precautions may lead to severe damage and injury to the person performing the installation.

**WARNING:**

The installation instructions described in this manual should be carefully followed in order to prevent damage to the components and injury to the user.

Before and during the installation please **DO** the following:

- Read the user manual:
 - The user manual provides a complete description of the ICE-BDE-T7 installation instructions and configuration options.
- Wear an electrostatic discharge cuff (ESD):
 - Electronic components are easily damaged by ESD. Wearing an ESD cuff removes ESD from the body and helps prevent ESD damage.
- Place the ICE-BDE-T7 on an antistatic pad:
 - When installing or configuring the motherboard, place it on an antistatic pad. This helps to prevent potential ESD damage.
- Turn all power to the ICE-BDE-T7 off:
 - When working with the ICE-BDE-T7, make sure that it is disconnected from all power supplies and that no electricity is being fed into the system.

Before and during the installation of the ICE-BDE-T7 **DO NOT**:

- Remove any of the stickers on the PCB board. These stickers are required for warranty validation.
- Use the product before verifying all the cables and power connectors are properly connected.
- Allow screws to come in contact with the PCB circuit, connector pins, or its components.

ICE-BDE-T7 COM Express Module

4.3 SO-DIMM Installation



WARNING:

1. Using incorrectly specified SO-DIMM may cause permanent damage to the ICE-BDE-T7. Please make sure the purchased SO-DIMM complies with the memory specifications of the ICE-BDE-T7. SO-DIMM specifications compliant with the ICE-BDE-T7 are listed in Chapter 1.
2. For dual channel configuration, always install two identical memory modules that feature the same capacity, timings, voltage, number of ranks and the same brand.

To install a SO-DIMM into a SO-DIMM socket, please follow the steps below and refer to **Figure 4-1**.

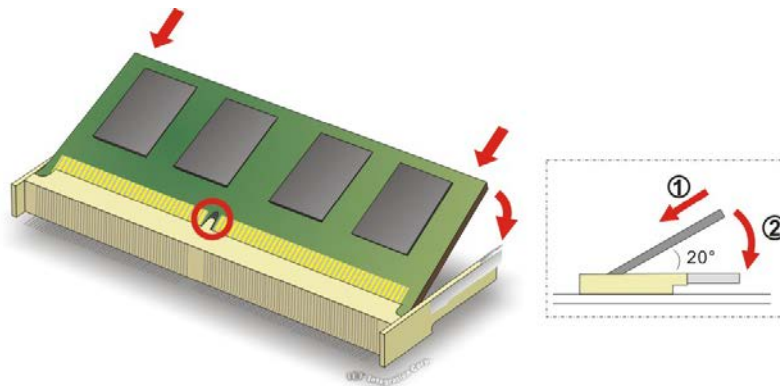

Figure 4-1: SO-DIMM Installation

- Step 1: Locate the SO-DIMM socket.** Place the ICE-BDE-T7 on an anti-static mat with the front side facing up.
- Step 2: Align the SO-DIMM with the socket.** Align the notch on the memory with the notch on the memory socket.
- Step 3: Insert the SO-DIMM.** Push the memory in at a 20° angle.
- Step 4: Seat the SO-DIMM.** Gently push downwards and the arms clip into place.

4.4 Mounting ICE-BDE-T7 to Baseboard

**NOTE:**

Baseboard can be designed by the end user, customized by IEI, or purchased from IEI. For more information visit the IEI website (www.ieiworld.com) or contact an IEI sales representative.

**WARNING:**

Never run the COM Express module without the heatsink and a thermal pad. The thermal pad acts as a thermal interface between the module and the heatsink. The heatsink must be installed on the ICE-BDE-T7 to maintain proper operating temperatures. Make sure to maintain the heatsink temperature under 60°C in operation.

Follow the steps below to install the ICE-BDE-T7 to the optional baseboard.

- Step 1:** Align the two COM Express connector on the solder side of the ICE-BDE-T7 with the corresponding connector on the baseboard. Gently push the COM Express module down to ensure the connectors are properly connected (Figure 4-2).

ICE-BDE-T7 COM Express Module

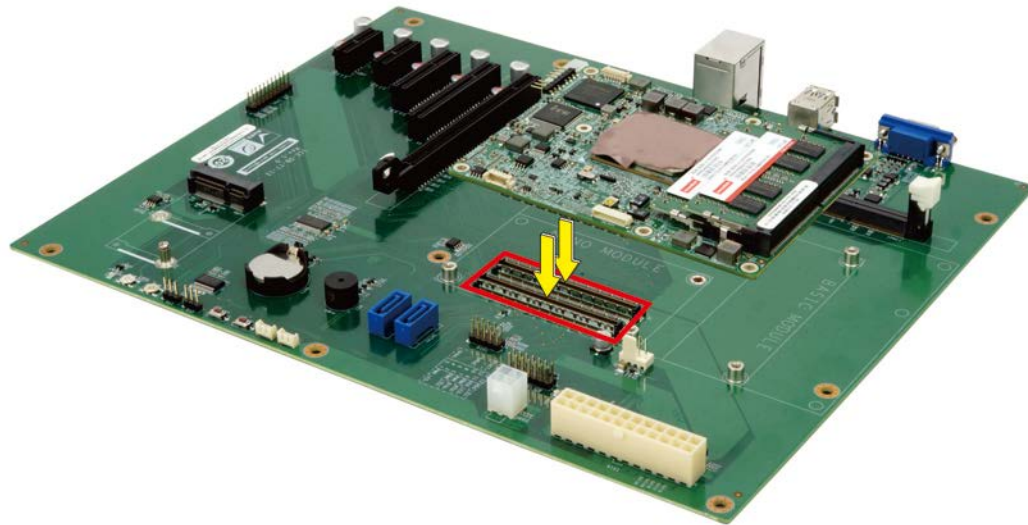

Figure 4-2: Connect the COM Express Connectors

- Step 2:** Ensure a thermal pad is placed on the CPU of the ICE-BDE-T7.
- Step 3:** Place the heatsink on the ICE-BDE-T7, aligning the retention screw holes (Figure 4-3).
- Step 4:** Secure the heatsink to the ICE-BDE-T7 and the baseboard with the supplied retention screws (Figure 4-3).

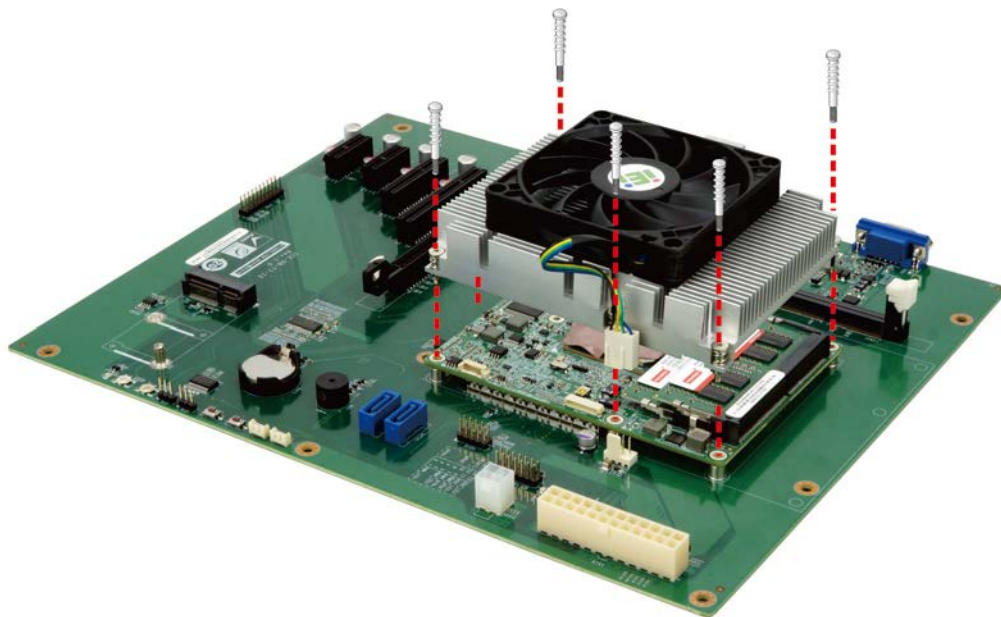

Figure 4-3: Secure the Heatsink

Chapter

5

BIOS

ICE-BDE-T7 COM Express Module

5.1 Introduction

The BIOS is programmed onto the BIOS chip. The BIOS setup program allows changes to certain system settings. This chapter outlines the options that can be changed.



NOTE:

Some of the BIOS options may vary throughout the life cycle of the product and are subject to change without prior notice.

5.1.1 Starting Setup

The UEFI BIOS is activated when the computer is turned on. The setup program can be activated in one of two ways.

1. Press the **DELETE** or **F2** key as soon as the system is turned on or
2. Press the **DELETE** or **F2** key when the “**Press Del to enter SETUP**” message appears on the screen.

If the message disappears before the **DELETE** or **F2** key is pressed, restart the computer and try again.

5.1.2 Using Setup

Use the arrow keys to highlight items, press **ENTER** to select, use the PageUp and PageDown keys to change entries, press **F1** for help and press **Esc** to quit. Navigation keys are shown in.

Key	Function
Up arrow	Move to previous item
Down arrow	Move to next item
Left arrow	Move to the item on the left hand side
Right arrow	Move to the item on the right hand side
+	Increase the numeric value or make changes

Key	Function
-	Decrease the numeric value or make changes
F1 key	General help, only for Status Page Setup Menu and Option Page Setup Menu
F2 key	Load previous values.
F3 key	Load optimized defaults
F4 key	Save changes and Exit BIOS
Esc key	Main Menu – Quit and not save changes into CMOS Status Page Setup Menu and Option Page Setup Menu -- Exit current page and return to Main Menu

5.1.3 Getting Help

When **F1** is pressed a small help window describing the appropriate keys to use and the possible selections for the highlighted item appears. To exit the Help Window press **Esc** or the **F1** key again.

5.1.4 Unable to Reboot after Configuration Changes

If the computer cannot boot after changes to the system configuration is made, CMOS defaults.

5.1.5 BIOS Menu Bar

The **menu bar** on top of the BIOS screen has the following main items:

- Main – Changes the basic system configuration.
- Advanced – Changes the advanced system settings.
- Chipset – Changes the chipset settings.
- Security – Sets User and Supervisor Passwords.
- Boot – Changes the system boot configuration.
- Save & Exit – Selects exit options and loads default settings

The following sections completely describe the configuration options found in the menu items at the top of the BIOS screen and listed above.

ICE-BDE-T7 COM Express Module

5.2 Main

The **Main** BIOS menu (**BIOS Menu 1**) appears when the **BIOS Setup** program is entered.

```

Aptio Setup Utility - Copyright (C) 2017 American Megatrends, Inc.
Main  Advanced  IntelRCSetup  Server Mgmt  Security  Boot  Event Logs  Save & Exit
BIOS Information
BIOS Vendor                American Megatrends
Core Version                5.11
Compliancy                 UEFI 2.4; PI 1.3
Project Version            B448AR10.ROM
Build Date and Time        10/11/2017 18:57:13

iWDD Vendor                iEi
iWDD Version                B448ET08.bin

Access Level                Administrator

Memory Information
Total Memory                16384 MB

System Date                [Fri 01/01/2010]
System Time                [00:18:35]

-----
<->: Select Screen
^ v: Select Item
Enter>Select
+/-: Change Opt.
F1:  General Help
F2:  Previous Values
F3:  Optimized
Defaults
F4:  Save & Exit
ESC: Exit

Version 2.18.1260. Copyright (C) 2017 American Megatrends, Inc.
  
```

BIOS Menu 1: Main

The System Overview field also has two user configurable fields:

➔ System Date [xx/xx/xx]

Use the **System Date** option to set the system date. Manually enter the day, month and year.

➔ System Time [xx:xx:xx]

Use the **System Time** option to set the system time. Manually enter the hours, minutes and seconds.

5.3 Advanced

Use the **Advanced** menu (**BIOS Menu 2**) to configure the CPU and peripheral devices through the following sub-menus:



WARNING!

Setting the wrong values in the sections below may cause the system to malfunction. Make sure that the settings made are compatible with the hardware.

```

Aptio Setup Utility - Copyright (C) 2017 American Megatrends, Inc.
Main  Advanced  IntelRCSetup  Server Mgmt  Security  Boot  Event Logs  Save & Exit
-----
Auto Power Button Status          [Disable (ATX)]          Select AC power state
                                when power is
Restore AC Power Loss             [Last State]            re-applied after a
                                power failure.
> Trusted Computing
> iWDD H/W Monitor
> iWDD Super IO Configuration
> RTC Wake Settings
> Serial Port Console Redirection
> USB Configuration
> iEi Feature

-----
<=>: Select Screen
↑ ↓: Select Item
Enter>Select
+/-: Change Opt.
F1: General Help
F2: Previous Values
F3: Optimized
Defaults
F4: Save & Exit
ESC: Exit

Version 2.18.1260. Copyright (C) 2017 American Megatrends, Inc.
    
```

BIOS Menu 2: Advanced

➔ **Restore AC Power Loss [Last State]**

Use the **Restore AC Power** BIOS option to specify what state the system returns to if there is a sudden loss of power to the system.

- ➔ **Power Off** The system remains turned off
- ➔ **Power On** The system turns on
- ➔ **Last State** **DEFAULT** The system returns to its previous state. If it was on, it turns itself on. If it was off, it remains off.

ICE-BDE-T7 COM Express Module

5.3.1 Trusted Computing

Use the **Trusted Computing** menu (**BIOS Menu 3**) to configure settings related to the Trusted Computing Group (TCG) Trusted Platform Module (TPM).

```

Aptio Setup Utility - Copyright (C) 2017 American Megatrends, Inc.
Main  Advanced  IntelRCSetup  Server Mgmt  Security  Boot  Event Logs  Save & Exit
-----
Configuration
Security Device Support          [Disable]
No Security Device Found

Enables or Disables
BIOS support for
security device. O.S.
will not show Security
Device. TCG EFI
protocol and INT1A
interface will not be
available.

-----

<=>: Select Screen
↑ ↓: Select Item
Enter>Select
+/-: Change Opt.
F1:  General Help
F2:  Previous Values
F3:  Optimized
Defaults
F4:  Save & Exit
ESC: Exit

Version 2.18.1260. Copyright (C) 2017 American Megatrends, Inc.
    
```

BIOS Menu 3: Trusted Computing

→ Security Device Support [Disable]

Use the **Security Device Support** option to configure support for the security device.

- **Disable** **DEFAULT** Security device support is disabled.
- **Enable** Security device support is enabled.

5.3.2 iWDD H/W Monitor

The **iWDD H/W Monitor** menu (**BIOS Menu 4**) contains the fan configuration submenus and displays operating temperature, fan speeds and system voltages.

```

Aptio Setup Utility - Copyright (C) 2017 American Megatrends, Inc.
Advanced
PC Health Status
CPU temperature           :+43 °C
System temperature       :+33 °C
CPU_FAN1 Speed           :2269 RPM
CPU_CORE                  :+1.791 V
+5V                       :+5.023 V
+12V                      :+11.806 V
+DDR                      :+1.208 V
+3.3V                     :+3.253 V
+3.3VSB                   :+3.277 V
> Smart Fan Mode Configuration

Smart Fan Mode Select
-----
<->: Select Screen
↑ ↓: Select Item
EnterSelect
+ - Change Opt.
F1  General Help
F2  Previous Values
F3  Optimized Defaults
F4  Save & Exit
ESC Exit

Version 2.18.1260. Copyright (C) 2017 American Megatrends, Inc.
    
```

BIOS Menu 4: iWDD H/W Monitor

➔ PC Health Status

The following system parameters and values are shown. The system parameters that are monitored are:

- Temperature
 - CPU temperature
 - System temperature
- CPU Fan Speed
- Voltages
 - CPU_CORE
 - +5V
 - +12V
 - +DDR
 - +5VSB
 - +3.3V

ICE-BDE-T7 COM Express Module

- +3.3VSB

5.3.2.1 Smart Fan Mode Configuration

Use the **Smart Fan Mode Configuration** submenu (**BIOS Menu 5**) to configure fan temperature and speed settings.

```

Aptio Setup Utility - Copyright (C) 2017 American Megatrends, Inc.
Advanced
Smart Fan Mode Configuration
CPU_FAN1 Smart Fan Control      [Auto Mode]
Auto mode fan start temperature 40
Auto mode fan off temperature   30
Auto mode fan start PWM         50
Auto mode fan slope PWM         2

Smart Fan Mode Select
-----
<->: Select Screen
↑ ↓: Select Item
Enter>Select
+ - Change Opt.
F1 General Help
F2 Previous Values
F3 Optimized Defaults
F4 Save & Exit
ESC Exit

Version 2.18.1260. Copyright (C) 2017 American Megatrends, Inc.
    
```

BIOS Menu 5: Smart Fan Mode Configuration

➔ CPU_FAN1 Smart Fan Control [Auto Mode]

Use the **CPU_FAN1 Smart Fan Control** BIOS option to configure the CPU Smart Fan.

- ➔ **Manual Mode** The fan spins at the speed set in the Manual Mode option
- ➔ **Auto Mode** **DEFAULT** The fan adjusts its speed using these settings:
 - Auto mode fan start temperature
 - Auto mode fan off temperature
 - Auto mode fan start PWM
 - Auto mode fan slope PWM

→ **Auto mode fan start temperature [40]**



WARNING:

Setting this value too high may cause the fan to rotate at full speed only when the CPU is at a very high temperature and therefore cause the system to be damaged.

The **Auto mode fan start temperature** option can only be set if the **CPU_FAN1 Smart Fan Control** option is set to **Auto Mode**. If the system temperature is between **Start Temperature** and **Off Temperature**, the fan speed change to be **Start PWM**. To set a value, select the **Auto mode fan start temperature** option and enter a decimal number between 1 and 100.

→ **Auto mode fan off temperature [30]**



WARNING:

Setting this value too high may cause the fan to speed up only when the CPU is at a very high temperature and therefore cause the system to be damaged.

The **Auto mode fan off temperature** option can only be set if the **CPU_FAN1 Smart Fan control** option is set to **Auto Mode**. If the system temperature is lower than **Auto mode fan off temperature**, the fan speed change to be lowest. To set a value, select the **Auto mode fan off temperature** option and enter a decimal number between 1 and 100.

→ **Auto mode fan start PWM [50]**

The **Auto mode fan start PWM** option can only be set if the **CPU_FAN1 Smart Fan control** option is set to **Auto Mode**. Use the **Auto mode fan start PWM** option to set the PWM start value. To set a value, select the **Auto mode fan start PWM** option and enter a decimal number between 1 and 100.

ICE-BDE-T7 COM Express Module

➔ Auto mode fan slope PWM [2]

The **Auto mode fan slope PWM** option can only be set if the **CPU_FAN1 Smart Fan control** option is set to **Auto Mode**. Use the **Auto mode fan slope PWM** option to select the linear rate at which the PWM mode increases with respect to an increase in temperature. To set a value, select the **Auto mode fan slope PWM** option and enter a decimal number between 1 and 8.

5.3.3 iWDD Super IO Configuration

Use the **iWDD Super IO Configuration** menu (**BIOS Menu 6**) to set or change the configurations for the serial ports.

```

Aptio Setup Utility - Copyright (C) 2017 American Megatrends, Inc.
  Advanced
iWDD Super IO Configuration
Super IO Chip                iWDD
> Serial Port 1 Configuration
> Serial Port 2 Configuration

Set Parameters of Serial
Port 1 (COMA)
-----
<-->: Select Screen
↑ ↓: Select Item
Enter>Select
F1   General Help
F2   Previous Values
F3   Optimized
Defaults
F4   Save
ESC  Exit

Version 2.18.1260. Copyright (C) 2017 American Megatrends, Inc.

```

BIOS Menu 6: iWDD Super IO Configuration

5.3.3.1 Serial Port n Configuration

Use the **Serial Port n Configuration** menu (**BIOS Menu 7**) to configure the serial port n.

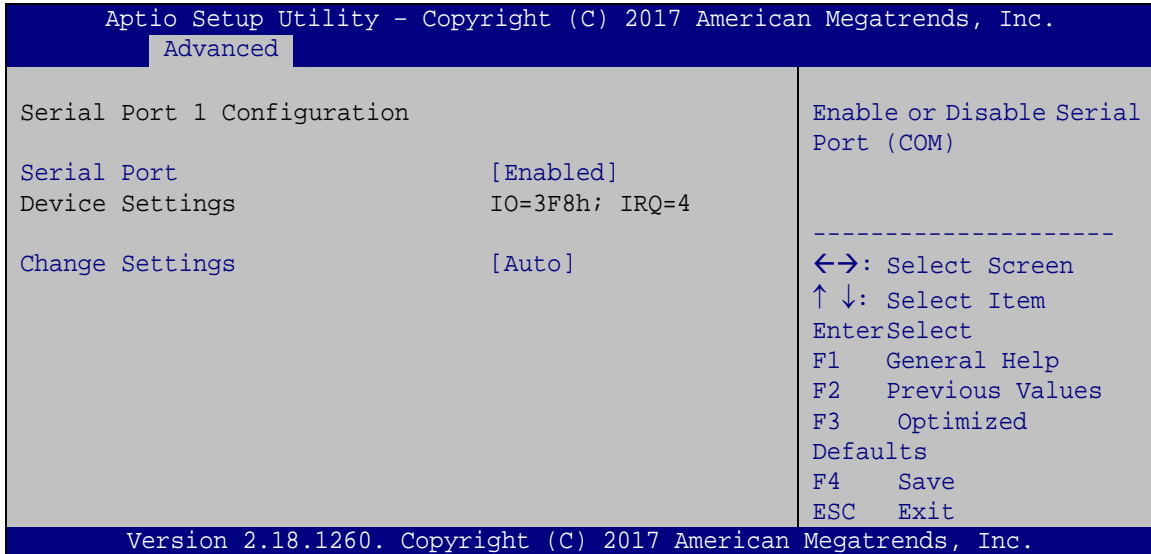

BIOS Menu 7: Serial Port n Configuration

5.3.3.1.1 Serial Port 1 Configuration

➔ Serial Port [Enabled]

Use the **Serial Port** option to enable or disable the serial port.

- ➔ **Disabled** Disable the serial port
- ➔ **Enabled** **DEFAULT** Enable the serial port

➔ Change Settings [Auto]

Use the **Change Settings** option to change the serial port IO port address and interrupt address.

- ➔ **Auto** **DEFAULT** The serial port IO port address and interrupt address are automatically detected.
- ➔ **IO=3F8h; IRQ=4** Serial Port I/O port address is 3F8h and the interrupt address is IRQ4

ICE-BDE-T7 COM Express Module

- | | |
|---|---|
| → IO=3F8h; IRQ=3,
4,5,6,7,9,10,11,12 | Serial Port I/O port address is 3F8h and the interrupt address is IRQ3,4,5,6,7,9,10,11,12 |
| → IO=2F8h; IRQ=3,
4,5,6,7,9,10,11,12 | Serial Port I/O port address is 2F8h and the interrupt address is IRQ3,4,5,6,7,9,10,11,12 |
| → IO=3E8h; IRQ=3,
4,5,6,7,9,10,11,12 | Serial Port I/O port address is 3E8h and the interrupt address is IRQ3,4,5,6,7,9,10,11,12 |
| → IO=2E8h; IRQ=3,
4,5,6,7,9,10,11,12 | Serial Port I/O port address is 2E8h and the interrupt address is IRQ3,4,5,6,7,9,10,11,12 |

5.3.3.1.2 Serial Port 2 Configuration

→ Serial Port [Enabled]

Use the **Serial Port** option to enable or disable the serial port.

- | | |
|------------|-------------------------|
| → Disabled | Disable the serial port |
| → Enabled | Enable the serial port |

DEFAULT

→ Change Settings [Auto]

Use the **Change Settings** option to change the serial port IO port address and interrupt address.

- | | | |
|---|----------------|---|
| → Auto | DEFAULT | The serial port IO port address and interrupt address are automatically detected. |
| → IO=2F8h; IRQ=3 | | Serial Port I/O port address is 2F8h and the interrupt address is IRQ3 |
| → IO=3F8h; IRQ=3,
4,5,6,7,9,10,11,12 | | Serial Port I/O port address is 3F8h and the interrupt address is IRQ3,4,5,6,7,9,10,11,12 |
| → IO=2F8h; IRQ=3,
4,5,6,7,9,10,11,12 | | Serial Port I/O port address is 2F8h and the interrupt address is IRQ3,4,5,6,7,9,10,11,12 |
| → IO=3E8h; IRQ=3,
4,5,6,7,9,10,11,12 | | Serial Port I/O port address is 3E8h and the interrupt address is IRQ3,4,5,6,7,9,10,11,12 |

➔ IO=2E8h; IRQ=3,
4,5,6,7,9,10,11,12

Serial Port I/O port address is 2E8h and the interrupt address is IRQ3,4,5,6,7,9,10,11,12

5.3.4 RTC Wake Settings

The **RTC Wake Settings** menu (**BIOS Menu 8**) configures RTC wake event.

```

Aptio Setup Utility - Copyright (C) 2017 American Megatrends, Inc.
Advanced
Wake system with Fixed Time      [Disabled]
Enable or disable System wake on alarm event. When enabled, System will wake on the date::hr::min::sec specified
-----
<=>: Select Screen
↑↓: Select Item
Enter>Select
F1   General Help
F2   Previous Values
F3   Optimized Defaults
F4   Save
ESC  Exit
Version 2.18.1260. Copyright (C) 2017 American Megatrends, Inc.
    
```

BIOS Menu 8: RTC Wake Settings

➔ Wake system with Fixed Time [Disabled]

Use the **Wake system with Fixed Time** option to enable or disable the system wake on alarm event.

- ➔ **Disabled** **DEFAULT** The real time clock (RTC) cannot generate a wake event
- ➔ **Enabled** If selected, the **Wake up every day** option appears allowing you to enable to disable the system to wake every day at the specified time. Besides, the following options appear with values that can be selected:

ICE-BDE-T7 COM Express Module

Wake up date

Wake up hour

Wake up minute

Wake up second

After setting the alarm, the computer turns itself on from a suspend state when the alarm goes off.

5.3.5 Serial Port Console Redirection

The **Serial Port Console Redirection** menu (**BIOS Menu 9**) allows the console redirection options to be configured. Console redirection allows users to maintain a system remotely by re-directing keyboard input and text output through the serial port.

```

Aptio Setup Utility - Copyright (C) 2017 American Megatrends, Inc.
  Advanced
COM1
  Console Redirection          [Disabled]
> Console Redirection Settings
COM2
  Console Redirection          [Disabled]
> Console Redirection Settings

Legacy Console Redirection
> Legacy Console Redirection Settings

-----
<->: Select Screen
↑ ↓: Select Item
Enter>Select
F1   General Help
F2   Previous Values
F3   Optimized
Defaults
F4   Save
ESC  Exit

Version 2.18.1260. Copyright (C) 2017 American Megatrends, Inc.
  
```

BIOS Menu 9: Serial Port Console Redirection

➔ Console Redirection [Disabled]

Use **Console Redirection** option to enable or disable the console redirection function.

- ➔ **Disabled** **DEFAULT** Disabled the console redirection function
- ➔ **Enabled** Enabled the console redirection function

5.3.5.1 Legacy Console Redirection Settings

The **Legacy Console Redirection Settings** menu (**BIOS Menu 10**) allows the legacy console redirection options to be configured.

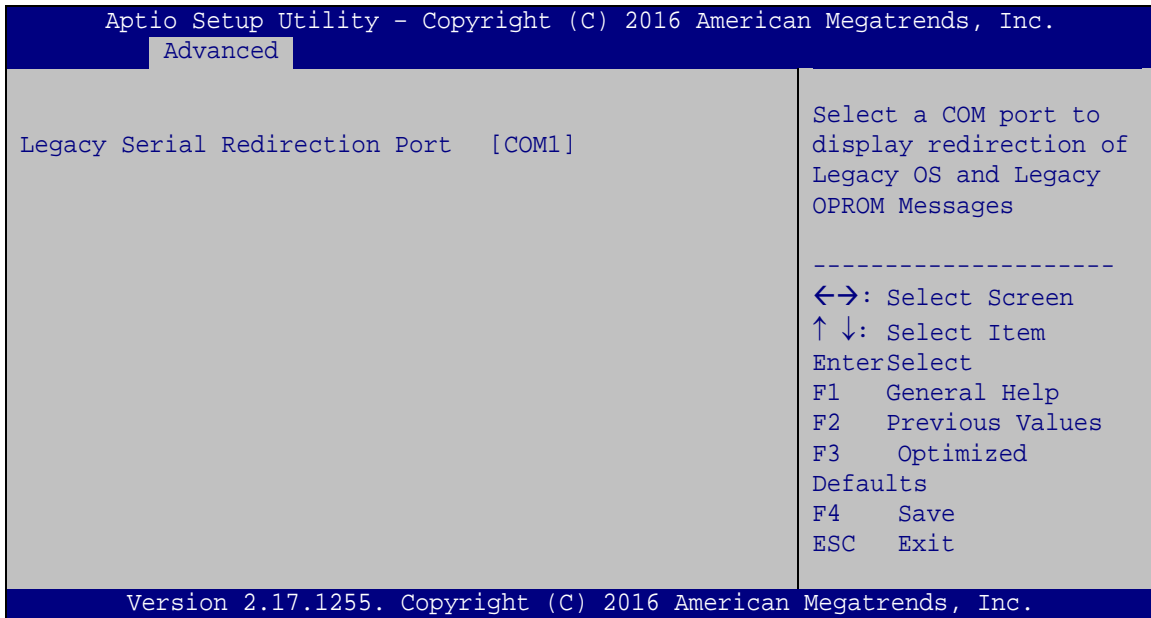

BIOS Menu 10: Legacy Console Redirection Settings

➔ Legacy Serial Redirection Port [COM1]

Use the **Legacy Serial Redirection Port** option to specify a COM port to display redirection of legacy OS and legacy OPRM messages. The options include:

- COM1 **DEFAULT**
- COM2

ICE-BDE-T7 COM Express Module

5.3.5.2 Console Redirection Settings

The **Console Redirection Settings** menu (**BIOS Menu 11**) allows the console redirection options to be configured. The option is active when Console Redirection option is enabled.

```

Aptio Setup Utility - Copyright (C) 2016 American Megatrends, Inc.
  Advanced
COM1
Console Redirection Settings

Terminal Type          [ANSI]
Bits per second       [115200]
Data Bits              [8]
Parity                 [None]
Stop Bits              [1]

Emulation: ANSI:
Extended ASCII char set.
VT100: ASCII char set.
VT100+: Extends VT100 to
support color, function
keys, etc. VT-UTF8: Uses
UTF8 encoding to map
Unicode chars onto 1 or
more bytes.

-----
<->: Select Screen
↑ ↓: Select Item
Enter>Select
F1   General Help
F2   Previous Values
F3   Optimized
Defaults
F4   Save
ESC  Exit

Version 2.17.1255. Copyright (C) 2016 American Megatrends, Inc.
  
```

BIOS Menu 11: Console Redirection Settings

➔ Terminal Type [ANSI]

Use the **Terminal Type** option to specify the remote terminal type.

- ➔ **VT100** The target terminal type is VT100
- ➔ **VT100+** The target terminal type is VT100+
- ➔ **VT-UTF8** The target terminal type is VT-UTF8
- ➔ **ANSI** **DEFAULT** The target terminal type is ANSI

→ Bits per second [115200]

Use the **Bits per second** option to specify the serial port transmission speed. The speed must match the other side. Long or noisy lines may require lower speeds.

- | | | |
|-----------------|----------------|--|
| → 9600 | | Sets the serial port transmission speed at 9600. |
| → 19200 | | Sets the serial port transmission speed at 19200. |
| → 38400 | | Sets the serial port transmission speed at 38400. |
| → 57600 | | Sets the serial port transmission speed at 57600. |
| → 115200 | DEFAULT | Sets the serial port transmission speed at 115200. |

→ Data Bits [8]

Use the **Data Bits** option to specify the number of data bits.

- | | | |
|------------|----------------|--------------------------|
| → 7 | | Sets the data bits at 7. |
| → 8 | DEFAULT | Sets the data bits at 8. |

→ Parity [None]

Use the **Parity** option to specify the parity bit that can be sent with the data bits for detecting the transmission errors.

- | | | |
|----------------|----------------|---|
| → None | DEFAULT | No parity bit is sent with the data bits. |
| → Even | | The parity bit is 0 if the number of ones in the data bits is even. |
| → Odd | | The parity bit is 0 if the number of ones in the data bits is odd. |
| → Mark | | The parity bit is always 1. This option does not provide error detection. |
| → Space | | The parity bit is always 0. This option does not provide error detection. |

ICE-BDE-T7 COM Express Module

➔ Stop Bits [1]

Use the **Stop Bits** option to specify the number of stop bits used to indicate the end of a serial data packet. Communication with slow devices may require more than 1 stop bit.

- ➔ 1 **DEFAULT** Sets the number of stop bits at 1.
- ➔ 2 Sets the number of stop bits at 2.

5.3.6 USB Configuration

Use the **USB Configuration** menu (**BIOS Menu 12**) to read USB configuration information and configure the USB settings.

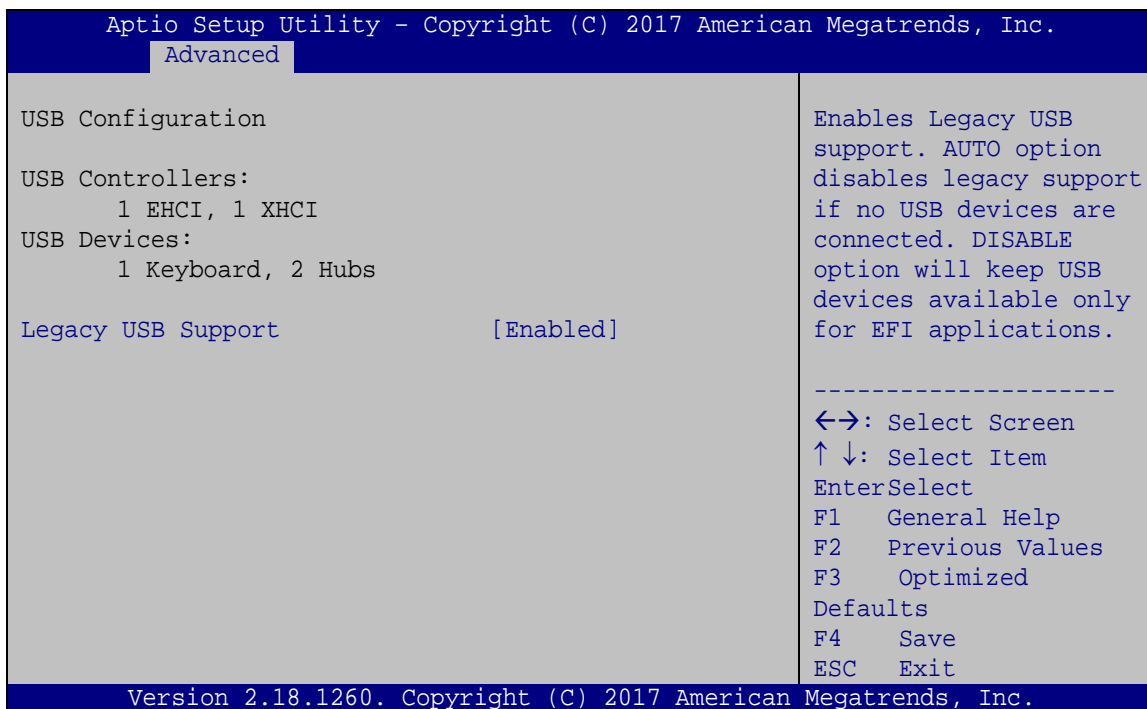

BIOS Menu 12: USB Configuration

➔ USB Devices

The **USB Devices Enabled** field lists the USB devices that are enabled on the system

➔ Legacy USB Support [Enabled]

Use the **Legacy USB Support** BIOS option to enable USB mouse and USB keyboard support. Normally if this option is not enabled, any attached USB mouse or USB keyboard does not become available until a USB compatible operating system is fully booted with all USB drivers loaded. When this option is enabled, any attached USB mouse or USB keyboard can control the system even when there is no USB driver loaded onto the system.

- ➔ **Enabled** **DEFAULT** Legacy USB support enabled
- ➔ **Disabled** Legacy USB support disabled
- ➔ **Auto** Legacy USB support disabled if no USB devices are connected

5.3.7 IEI Feature

Use the **IEI Feature** menu (**BIOS Menu 13**) to configure One Key Recovery function.

```

Aptio Setup Utility - Copyright (C) 2017 American Megatrends, Inc.
  Advanced
-----
iEi Feature
Auto Recovery Function                      [Disabled]
Auto Recovery Function                      Reboot and recover
                                           system automatically
                                           within 10 min, when OS
                                           crashes. Please install
                                           Auto Recovery API
                                           service before enabling
                                           this function
                                           -----
                                           ←→: Select Screen
                                           ↑↓: Select Item
                                           Enter>Select
                                           F1    General Help
                                           F2    Previous Values
                                           F3    Optimized Defaults
                                           F4    Save
                                           ESC   Exit
Version 2.18.1260. Copyright (C) 2017 American Megatrends, Inc.
  
```

BIOS Menu 13: IEI Feature

ICE-BDE-T7 COM Express Module

➔ Auto Recovery Function [Disabled]

Use the **Auto Recovery Function** BIOS option to enable or disable the auto recovery function of the IEI One Key Recovery.

- ➔ **Disabled** **DEFAULT** Auto recovery function disabled
- ➔ **Enabled** Auto recovery function enabled

5.4 IntelRCSetup

Use the **IntelRCSetup** menu (**BIOS Menu 14**) to configure the system processor and chipset.

```

Aptio Setup Utility - Copyright (C) 2017 American Megatrends, Inc.
Main  Advanced  IntelRCSetup  Server Mgmt  Security  Boot  Event Logs  Save & Exit

> Processor Configuration      Displays and provides
> IIO Configuration          option to change the
> PCH Configuration           Processor Settings

-----
<=>: Select Screen
↑ ↓: Select Item
Enter>Select
+/-: Change Opt.
F1:  General Help
F2:  Previous Values
F3:  Optimized
     Defaults
F4:  Save & Exit
ESC: Exit

Version 2.18.1260. Copyright (C) 2017 American Megatrends, Inc.

```

BIOS Menu 14: IntelRCSetup

5.4.1 Processor Configuration

Use the **Processor Configuration** menu (**BIOS Menu 15**) to view detailed CPU specifications and configure the CPU.

```

Aptio Setup Utility - Copyright (C) 2017 American Megatrends, Inc.
IntelRCSetup
-----
CPU Configuration
-----
Processor Socket          Socket 0
Processor ID              00050663*
Processor Frequency      2.200GHz
Processor Max Ratio      16H
Processor Min Ratio      08H
Microcode Revision       0700000C
L1 Cache RAM              256KB
L2 Cache RAM              1024KB
L3 Cache RAM              6144KB
Processor 0 Version       Intel(R) Xeon(R) D-
                          1518 @ 2.20GHz

Hyper-Threading           [Enable]
Intel TXT                  [Disable]
VMX                        [Disable]
EIST                       [Enable]
CPU C state                [Disable]

Enable Hyper Threading
(Software Method to
Enable/Disable Logical
Processor threads.)

-----
<->: Select Screen
^ v: Select Item
EnterSelect
+ - Change Opt.
F1 General Help
F2 Previous Values
F3 Optimized Defaults
F4 Save & Exit
ESC Exit

Version 2.18.1260. Copyright (C) 2017 American Megatrends, Inc.
  
```

BIOS Menu 15: Processor Configuration

➔ Hyper-Threading [Enable]

Use the **Hyper-Threading** to enable or disable the CPU hyper threading function.

- ➔ **Disable** Disables the use of hyper threading technology
- ➔ **Enable** **DEFAULT** Enables the use of hyper threading technology

ICE-BDE-T7 COM Express Module

→ Intel TXT [Disable]

Use the **Intel TXT** BIOS option to enable or disable Intel® Trusted Execution Technology.

- **Disable** **DEFAULT** Disables the use of Intel® Trusted Execution technology
- **Enable** Enables the use of Intel® Trusted Execution technology

→ VMX [Disable]

Use the **VMX** option to enable or disable virtualization on the system. When combined with third party software, Intel® Virtualization technology allows several OSs to run on the same system at the same time.

- **Disable** **DEFAULT** Disables Intel® Virtualization Technology.
- **Enable** Enables Intel® Virtualization Technology.

→ EIST [Enable]

Use the **EIST** option to enable or disable the Intel® SpeedStep Technology.

- **Disable** **DEFAULT** Disables the Intel® SpeedStep Technology.
- **Enable** Enables the Intel® SpeedStep Technology.

→ CPU C State [Disable]

Use the **CPU C State** option to enable or disable CPU C state.

- **Disable** **DEFAULT** Disables CPU C state.
- **Enable** Enables CPU C state.

5.4.2 IIO Configuration

Use the **IIO Configuration** menu (**BIOS Menu 16**) to configure the IIO parameters.

```

Aptio Setup Utility - Copyright (C) 2017 American Megatrends, Inc.
IntelRCsetup
-----
IIO Configuration
-----
> IIO Configuration
> Intel VT for Directed I/O (VT-d)
> IIO South Complex Configuration
-----
<=>: Select Screen
↑↓: Select Item
EnterSelect
+ - Change Opt.
F1 General Help
F2 Previous Values
F3 Optimized Defaults
F4 Save & Exit
ESC Exit
-----
Version 2.18.1260. Copyright (C) 2017 American Megatrends, Inc.

```

BIOS Menu 16: IIO Configuration

5.4.2.1 IIO0 Configuration

Use the **IIO0 Configuration** submenu (**BIOS Menu 17**) to configure the PCI Express slots from IIO.

```

Aptio Setup Utility - Copyright (C) 2017 American Megatrends, Inc.
IntelRCsetup
-----
> PCIEX8_1
> PCIEX16
-----
Settings related to PCI Express Ports
-----
<=>: Select Screen
↑↓: Select Item
EnterSelect
+ - Change Opt.
F1 General Help
F2 Previous Values
F3 Optimized Defaults
F4 Save & Exit
ESC Exit
-----
Version 2.18.1260. Copyright (C) 2017 American Megatrends, Inc.

```

BIOS Menu 17: IIO0 Configuration

ICE-BDE-T7 COM Express Module

The PCIe slot submenus all contain the following options:

➔ Link Speed [Auto]

Use the **Link Speed** option to configure the PCIe interface speed.

- Auto DEFAULT
- Gen 1 (2.5 GT/s)
- Gen 2 (5 GT/s)
- Gen 3 (8 GT/s)

5.4.2.2 Intel VT for Directed I/O (VT-d)

Use the **Intel VT for Directed I/O (VT-d)** submenu (**BIOS Menu 18**) to configure the VT-d settings.

```

Aptio Setup Utility - Copyright (C) 2017 American Megatrends, Inc.
  IntelRCSetup
-----
Intel VT for Directed I/O (VT-d)
Intel VT for Directed I/O (VT-d)  [Disable]

Enable/Disable Intel
Virtualization Technology
for Directed I/O (VT-d) by
reporting the I/O device
assignment to VMM through
DMAR ACPI Tables.

-----
<->: Select Screen
↑ ↓: Select Item
Enter>Select
+ - Change Opt.
F1 General Help
F2 Previous Values
F3 Optimized Defaults
F4 Save & Exit
ESC Exit

Version 2.18.1260. Copyright (C) 2017 American Megatrends, Inc.

```

BIOS Menu 18: Intel VT for Directed I/O (VT-d)

➔ VT-d Intel VT for Directed I/O (VT-d) [Disable]

Use the **Intel VT for Directed I/O (VT-d)** option to enable or disable VT-d support.

- ➔ **Disable** **DEFAULT** Disable VT-d support.
- ➔ **Enable** Enable VT-d support.

5.4.2.3 IIO South Complex Configuration

Use the **IIO South Complex** submenu (**BIOS Menu 19**) to configure South Complex settings.

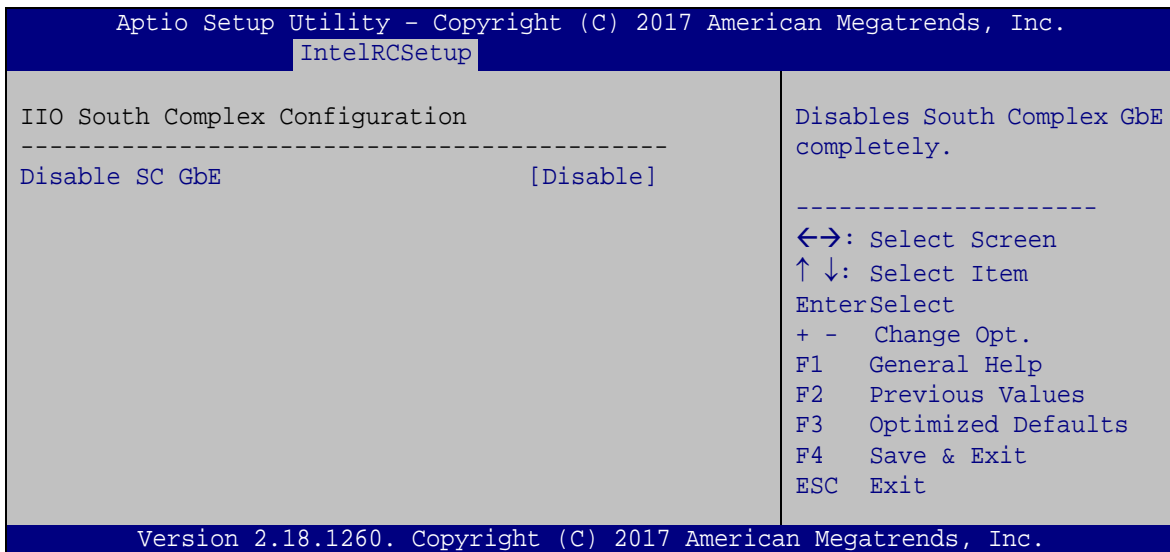

BIOS Menu 19: IIO South Complex Configuration

➔ Disable SC GbE [Disable]

Use the **Disable SC GbE** option to completely enable or disable GbE.

- ➔ **Disable** **DEFAULT** Disable GbE completely.
- ➔ **Enable** Enable GbE completely.

ICE-BDE-T7 COM Express Module

5.4.3 PCH Configuration

Use the **PCH Configuration** menu (**BIOS Menu 20**) to configure the PCH chipset.

```

Aptio Setup Utility - Copyright (C) 2017 American Megatrends, Inc.
  IntelRCSetup
-----
PCH Configuration
-----
> PCI Express Configuration
> PCH SATA Configuration

PCI Express Configuration
settings
-----
<->: Select Screen
↑ ↓: Select Item
EnterSelect
+ - Change Opt.
F1 General Help
F2 Previous Values
F3 Optimized Defaults
F4 Save & Exit
ESC Exit

Version 2.18.1260. Copyright (C) 2017 American Megatrends, Inc.
  
```

BIOS Menu 20: PCH Configuration

5.4.3.1 PCI Express Configuration

Use the **PCI Express Configuration** submenu (**BIOS Menu 21**) to configure the PCI Express slots from PCH.

```

Aptio Setup Utility - Copyright (C) 2017 American Megatrends, Inc.
  IntelRCsetup
-----
> PCIEX1
> PCIEX2
> PCIEX4_1

PCIE1 Settings
-----
<->: Select Screen
↑ ↓: Select Item
EnterSelect
+ - Change Opt.
F1 General Help
F2 Previous Values
F3 Optimized Defaults
F4 Save & Exit
ESC Exit

Version 2.18.1260. Copyright (C) 2017 American Megatrends, Inc.
  
```

BIOS Menu 21: PCI Express Configuration

The PCIe slot submenus all contain the following options:

➔ PCIe Speed [Auto]

Use the **PCIe Speed** option to configure the PCIe interface speed.

- Auto **DEFAULT**
- Gen 1
- Gen 2

5.4.3.2 PCH SATA Configuration

Use the **PCH SATA Configuration** menu (**BIOS Menu 22**) to change and/or set the configuration of the SATA devices installed in the system.

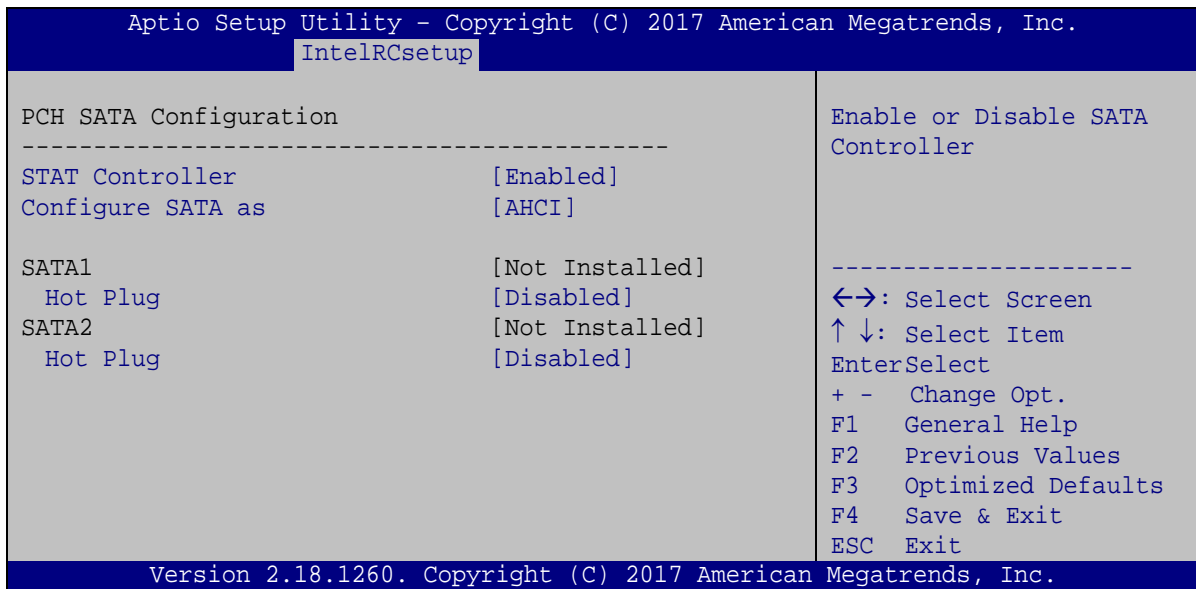

BIOS Menu 22: PCH SATA Configuration

➔ STAT Controller [Enabled]

Use the **STAT Controller** option to enable or disable the SATA device.

- ➔ Disabled Disables the SATA device.
- ➔ Enabled **DEFAULT** Enables the SATA device.

ICE-BDE-T7 COM Express Module

→ Configure SATA as [AHCI]

Use the **Configure SATA as** option to configure SATA devices as IDE, AHCI or RAID devices.

- **IDE** Configures SATA devices as IDE device.
- **AHCI** **DEFAULT** Configures SATA devices as AHCI device.
- **RAID** Configures SATA devices as RAID device.

→ Hot Plug [Disabled]

Use the **Hot Plug** option to enable or disable the SATA device hot plug.

- **Disabled** **DEFAULT** Disables the SATA device hot plug.
- **Enabled** Enables the SATA device hot plug

5.5 Server Management

Use the **Server Management** menu (**BIOS Menu 23**) to display the server management status and change the settings.

```

Aptio Setup Utility - Copyright (C) 2017 American Megatrends, Inc.
Main  Advanced  IntelRCSetup  Server Mgmt  Security  Boot  Event Logs  Save & Exit
-----
BMC Self Test Status          FAILED
BMC Firmware Revision        Unknown
> System Event Log

Press <Enter> to
change the SEL event
log configuration.

-----

<=>: Select Screen
↑ ↓: Select Item
EnterSelect
+/-: Change Opt.
F1:  General Help
F2:  Previous Values
F3:  Optimized
Defaults
F4:  Save & Exit
ESC: Exit

Version 2.18.1260. Copyright (C) 2017 American Megatrends, Inc.
  
```

BIOS Menu 23: Server Management

5.5.1 System Event Log

Use the **System Event Log** submenu (**BIOS Menu 24**) to configure the System Event Log (SEL) options.

ICE-BDE-T7 COM Express Module

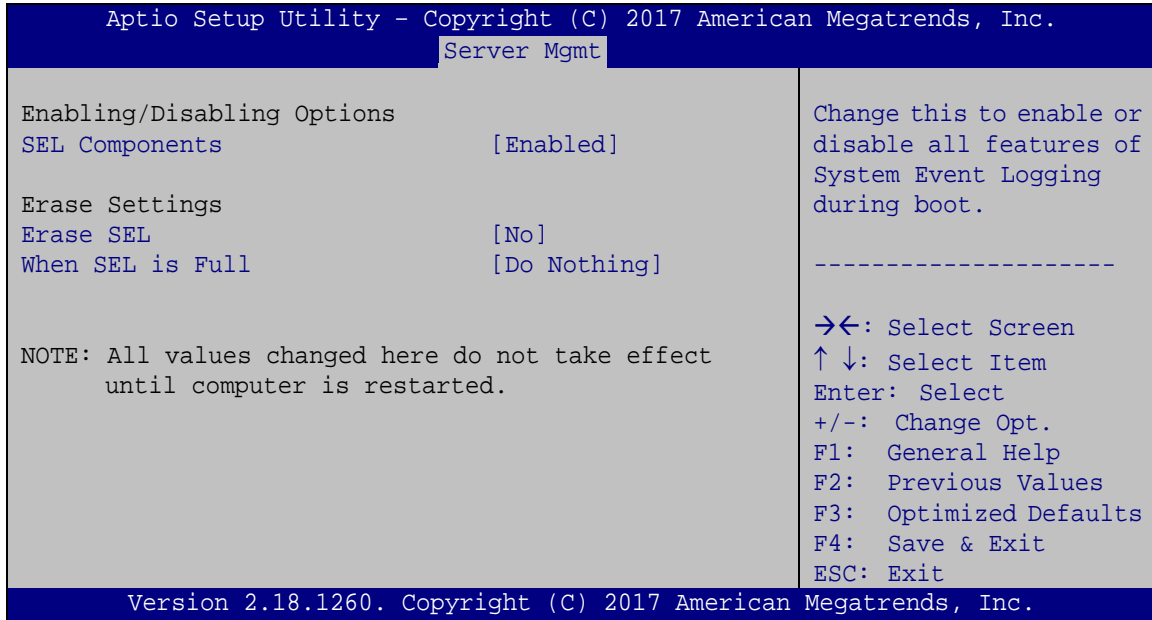

BIOS Menu 24: System Event Log

→ SEL Components [Enabled]

Use the **SEL Components** option to enable or disable all features of System Event Log.

- **Disabled** Disables SEL
- **Enabled** **DEFAULT** Enables SEL



NOTE:

The following two items will be available to configure when the **SEL Components** is enabled.

→ Erase SEL [No]

Use the **Erase SEL** option to determine whether to erase SEL or not. The following options are available:

- No **Default**
- Yes, On next reset
- Yes, On every reset

→ When SEL is full [Do Nothing]

Use the **When SEL is Full** option to determine the action to be taken when SEL is full.

The following options are available:

- Do Nothing **Default**
- Erase Immediately

5.6 Security

Use the **Security** menu (**BIOS Menu 25**) to set system and user passwords.

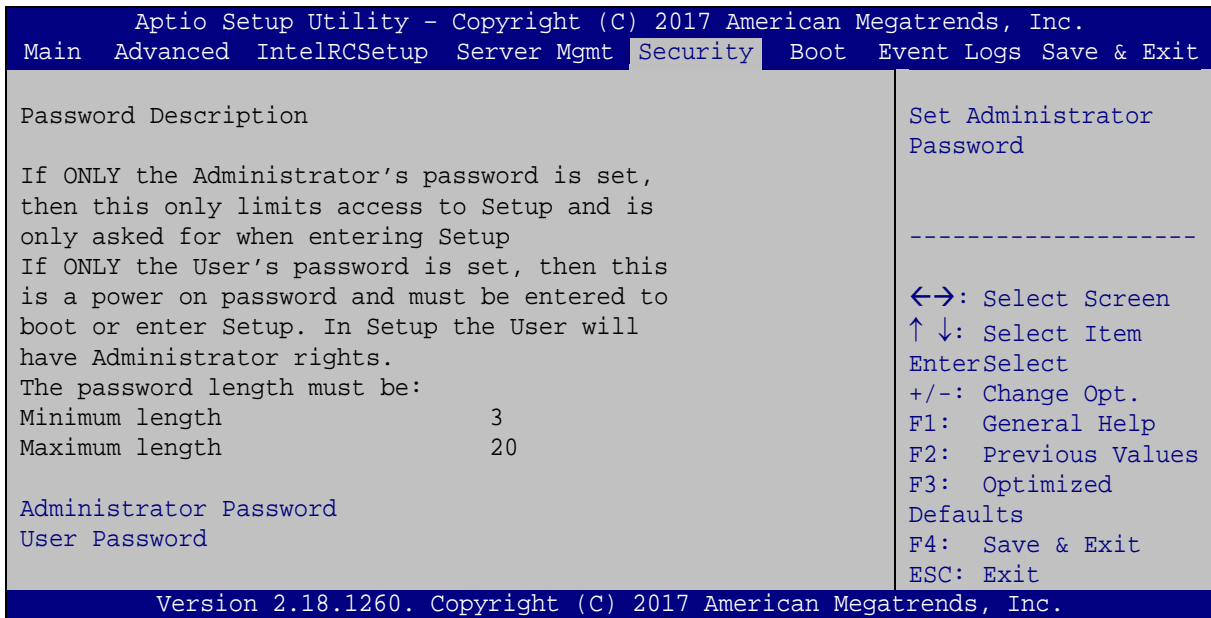

BIOS Menu 25: Security

→ Administrator Password

Use the **Administrator Password** to set or change a administrator password.

→ User Password

Use the **User Password** to set or change a user password.

ICE-BDE-T7 COM Express Module

5.7 Boot

Use the **Boot** menu (**BIOS Menu 26**) to configure system boot options.

```

Aptio Setup Utility - Copyright (C) 2017 American Megatrends, Inc.
Main  Advanced  IntelRCSetup  Server Mgmt  Security  Boot  Event Logs  Save & Exit

Boot Configuration
Bootup NumLock State      [On]
Quiet Boot                 [Enabled]
UEFI Boot                 [Disabled]

Driver Option Riorities
Launch PXE OpROM          [Disabled]
Option ROM Messages       [Force BIOS]

Boot Option Priorities

-----
<->: Select Screen
^ v: Select Item
EnterSelect
+/-: Change Opt.
F1:  General Help
F2:  Previous Values
F3:  Optimized
Defaults
F4:  Save & Exit
ESC: Exit

Version 2.18.1260. Copyright (C) 2017 American Megatrends, Inc.

```

BIOS Menu 26: Boot

➔ Bootup NumLock State [On]

Use the **Bootup NumLock State** BIOS option to specify if the number lock setting must be modified during boot up.

➔	On	DEFAULT	Allows the Number Lock on the keyboard to be enabled automatically when the computer system boots up. This allows the immediate use of the 10-key numeric keypad located on the right side of the keyboard. To confirm this, the Number Lock LED light on the keyboard is lit.
---	-----------	----------------	--

- ➔ **Off** Does not enable the keyboard Number Lock automatically. To use the 10-keys on the keyboard, press the Number Lock key located on the upper left-hand corner of the 10-key pad. The Number Lock LED on the keyboard lights up when the Number Lock is engaged.

➔ **Quiet Boot [Enabled]**

Use the **Quiet Boot** BIOS option to select the screen display when the system boots.

- ➔ **Disabled** Normal POST messages displayed
- ➔ **Enabled** **DEFAULT** OEM Logo displayed instead of POST messages

➔ **UEFI Boot [Disabled]**

Use the **UEFI Boot** option to enable or disable to boot from the UEFI devices.

- ➔ **Enabled** Boot from UEFI devices is enabled.
- ➔ **Disabled** **DEFAULT** Boot from UEFI devices is disabled.

➔ **Launch PXE OpROM [Disabled]**

Use the **Launch PXE OpROM** option to enable or disable boot option for legacy network devices.

- ➔ **Disabled** **DEFAULT** Ignore all PXE Option ROMs
- ➔ **Enabled** Load PXE Option ROMs.

➔ **Option ROM Messages [Force BIOS]**

Use the **Option ROM Messages** option to set the Option ROM display mode.

- ➔ **Force BIOS** **DEFAULT** Sets display mode to force BIOS.

ICE-BDE-T7 COM Express Module

- ➔ **Keep Current** Sets display mode to current.

➔ **Boot Option Priority**

Use the **Boot Option Priority** function to set the system boot sequence from the available devices. The drive sequence also depends on the boot sequence in the individual device section.

5.8 Save & Exit

Use the **Save & Exit** menu (**BIOS Menu 27**) to load default BIOS values, optimal failsafe values and to save configuration changes.

```

Aptio Setup Utility - Copyright (C) 2017 American Megatrends, Inc.
Main  Advanced  IntelRCSetup  Server Mgmt  Security  Boot  Event Logs  Save & Exit

Save Changes and Reset
Discard Changes and Reset

Restore Defaults
Save as User Defaults
Restore User Defaults

Reset the system after
saving the changes.

-----
<->: Select Screen
↑ ↓: Select Item
EnterSelect
+/-: Change Opt.
F1:  General Help
F2:  Previous Values
F3:  Optimized
Defaults
F4:  Save & Exit
ESC: Exit

Version 2.18.1260. Copyright (C) 2017 American Megatrends, Inc.

```

BIOS Menu 27: Save & Exit

➔ **Save Changes and Reset**

Use the **Save Changes and Reset** option to save the changes made to the BIOS options and to exit the BIOS configuration setup program.

➔ **Discard Changes and Reset**

Use the **Discard Changes and Reset** option to exit the system without saving the changes made to the BIOS configuration setup program.

➔ **Restore Defaults**

Use the **Restore Defaults** option to load the optimal default values for each of the parameters on the Setup menus. **F3 key can be used for this operation.**

➔ **Save as User Defaults**

Use the **Save as User Defaults** option to save the changes done so far as user defaults.

➔ **Restore User Defaults**

Use the **Restore User Defaults** option to restore the user defaults to all the setup options.

Chapter

6

Software Drivers

6.1 Available Drivers

All the drivers for the ICE-BDE-T7 are available on IEI Resource Download Center (<https://download.ieiworld.com>). Type ICE-BDE-T7 and press Enter to find all the relevant software, utilities, and documentation.

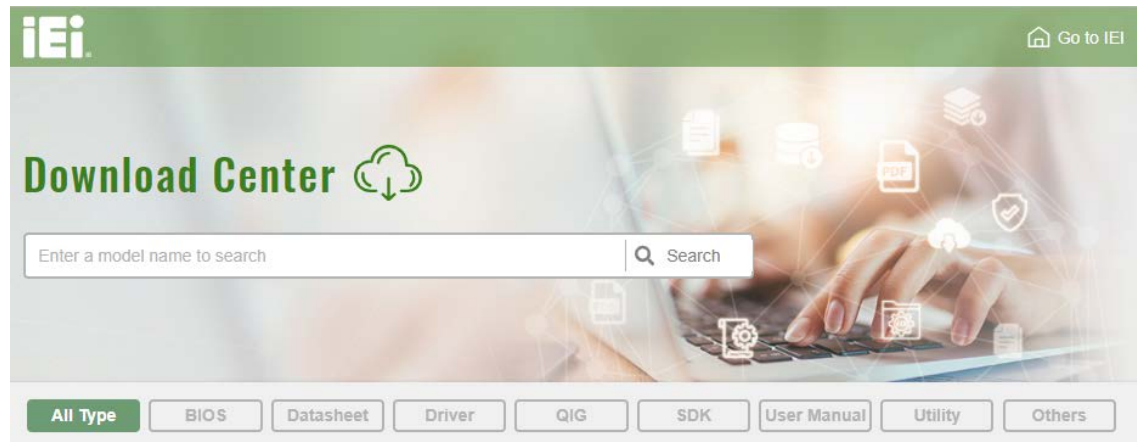
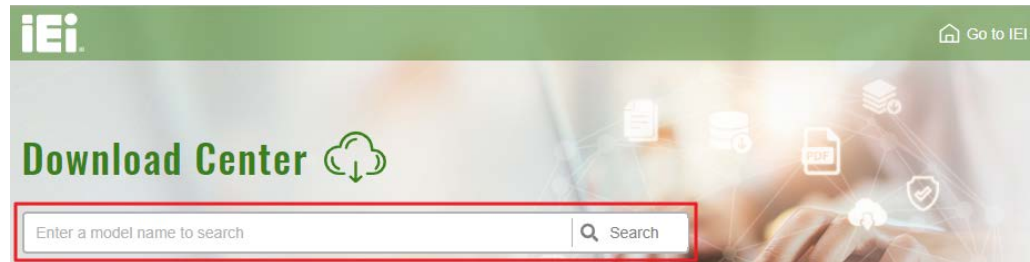

Figure 6-1: IEI Resource Download Center

6.2 Driver Download

To download drivers from IEI Resource Download Center, follow the steps below.

Step 1: Go to <https://download.ieiworld.com>. Type ICE-BDE-T7 and press Enter.



Step 2: All product-related software, utilities, and documentation will be listed. You can choose **Driver** to filter the result.

ICE-BDE-T7 COM Express Module

[All Type](#)
[BIOS](#)
[Datasheet](#)
[Driver](#)
[QIG](#)
[SDK](#)
[User Manual](#)
[Utility](#)
[Others](#)

WAFER-BT-i1 [Product Info](#)

[Embedded Computer](#) ▶ [Single Board Computer](#) ▶ [Embedded Board](#)
 3.5" SBC with Intel® 22nm Atom™/Celeron® on-board SoC

Driver

File Name	Published	Version	File Checksum
7B000-001033-RS V2.3.iso (2.23 GB)	2017/10/03	2.30	3B2DB1F792779A93A8F50DDBC3943E30

Step 3: Click the driver file name on the page and you will be prompted with the following window. You can download the entire ISO file (❶), or click the small arrow to find an individual driver and click the file name to download (❷).

7B000-001168-RS_V1.4.iso

❶ [Click here to download entire ISO file. \(2.99 GB\)](#)

* Download individual file *

❷

- Docs
 - 1.Chipset
 - 10.1.1.12.zip (2.7 MB)
 - 2.VGA
 - 3.Audio
 - 4.Lan
 - 5.USB 3.0
 - 6.Serial IO
 - 7.TXE
 - 8.Manual



NOTE:

To install software from the downloaded ISO image file in Windows 8, 8.1 or 10, double-click the ISO file to mount it as a virtual drive to view its content. On Windows 7 system, an additional tool (such as Virtual CD-ROM Control Panel from Microsoft) is needed to mount the file.

Appendix

A

Regulatory Compliance

ICE-BDE-T7 COM Express Module

DECLARATION OF CONFORMITY



This equipment has been tested and found to comply with specifications for CE marking. If the user modifies and/or installs other devices in the equipment, the CE conformity declaration may no longer apply.

FCC WARNING



This equipment complies with Part 15 of the FCC Rules. Operation is subject to the following two conditions:

- This device may not cause harmful interference, and
- This device must accept any interference received, including interference that may cause undesired operation.

This equipment has been tested and found to comply with the limits for a Class A digital device, pursuant to part 15 of the FCC Rules. These limits are designed to provide reasonable protection against harmful interference when the equipment is operated in a commercial environment. This equipment generates, uses, and can radiate radio frequency energy and, if not installed and used in accordance with the instruction manual, may cause harmful interference to radio communications. Operation of this equipment in a residential area is likely to cause harmful interference in which case the user will be required to correct the interference at his own expense.

Appendix

B

Product Disposal

ICE-BDE-T7 COM Express Module



CAUTION:

Risk of explosion if battery is replaced by an incorrect type. Only certified engineers should replace the on-board battery.

Dispose of used batteries according to instructions and local regulations.

- Outside the European Union – If you wish to dispose of used electrical and electronic products outside the European Union, please contact your local authority so as to comply with the correct disposal method.
- Within the European Union – The device that produces less waste and is easier to recycle is classified as electronic device in terms of the European Directive 2012/19/EU (WEEE), and must not be disposed of as domestic garbage.

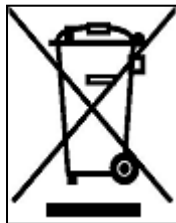

EU-wide legislation, as implemented in each Member State, requires that waste electrical and electronic products carrying the mark (left) must be disposed of separately from normal household waste. This includes monitors and electrical accessories, such as signal cables or power cords. When you need to dispose of your device, please follow the guidance of your local authority, or ask the shop where you purchased the product. The mark on electrical and electronic products only applies to the current European Union Member States.

Please follow the national guidelines for electrical and electronic product disposal.

Appendix

C

BIOS Options

ICE-BDE-T7 COM Express Module

Below is a list of BIOS configuration options in the BIOS chapter.

<input type="checkbox"/>	System Date [xx/xx/xx]	39
<input type="checkbox"/>	System Time [xx:xx:xx]	39
<input type="checkbox"/>	Restore AC Power Loss [Last State]	40
<input type="checkbox"/>	Security Device Support [Disable]	41
<input type="checkbox"/>	PC Health Status	42
<input type="checkbox"/>	CPU_FAN1 Smart Fan Control [Auto Mode]	43
<input type="checkbox"/>	Auto mode fan start temperature [40]	44
<input type="checkbox"/>	Auto mode fan off temperature [30]	44
<input type="checkbox"/>	Auto mode fan start PWM [50]	44
<input type="checkbox"/>	Auto mode fan slope PWM [2]	45
<input type="checkbox"/>	Serial Port [Enabled]	46
<input type="checkbox"/>	Change Settings [Auto]	46
<input type="checkbox"/>	Serial Port [Enabled]	47
<input type="checkbox"/>	Change Settings [Auto]	47
<input type="checkbox"/>	Wake system with Fixed Time [Disabled]	48
<input type="checkbox"/>	Console Redirection [Disabled]	50
<input type="checkbox"/>	Legacy Serial Redirection Port [COM1]	50
<input type="checkbox"/>	Terminal Type [ANSI]	51
<input type="checkbox"/>	Bits per second [115200]	52
<input type="checkbox"/>	Data Bits [8]	52
<input type="checkbox"/>	Parity [None]	52
<input type="checkbox"/>	Stop Bits [1]	53
<input type="checkbox"/>	USB Devices	53
<input type="checkbox"/>	Legacy USB Support [Enabled]	54
<input type="checkbox"/>	Auto Recovery Function [Disabled]	55
<input type="checkbox"/>	Hyper-Threading [Enable]	56
<input type="checkbox"/>	Intel TXT [Disable]	57
<input type="checkbox"/>	VMX [Disable]	57
<input type="checkbox"/>	EIST [Enable]	57
<input type="checkbox"/>	CPU C State [Disable]	57
<input type="checkbox"/>	Link Speed [Auto]	59
<input type="checkbox"/>	VT-d Intel VT for Directed I/O (VT-d) [Disable]	60
<input type="checkbox"/>	Disable SC GbE [Disable]	60

<input type="checkbox"/>	PCIe Speed [Auto].....	62
<input type="checkbox"/>	STAT Controller [Enabled].....	62
<input type="checkbox"/>	Configure SATA as [AHCI].....	63
<input type="checkbox"/>	Hot Plug [Disabled].....	63
<input type="checkbox"/>	SEL Components [Enabled].....	65
<input type="checkbox"/>	Erase SEL [No].....	65
<input type="checkbox"/>	When SEL is full [Do Nothing].....	66
<input type="checkbox"/>	Administrator Password.....	66
<input type="checkbox"/>	User Password.....	66
<input type="checkbox"/>	Bootup NumLock State [On].....	67
<input type="checkbox"/>	Quiet Boot [Enabled].....	68
<input type="checkbox"/>	UEFI Boot [Disabled].....	68
<input type="checkbox"/>	Launch PXE OpROM [Disabled].....	68
<input type="checkbox"/>	Option ROM Messages [Force BIOS].....	68
<input type="checkbox"/>	Boot Option Priority.....	69
<input type="checkbox"/>	Save Changes and Reset.....	69
<input type="checkbox"/>	Discard Changes and Reset.....	70
<input type="checkbox"/>	Restore Defaults.....	70
<input type="checkbox"/>	Save as User Defaults.....	70
<input type="checkbox"/>	Restore User Defaults.....	70

Appendix

D

Digital I/O Interface

The DIO connector on the ICE-BDE-T7 is interfaced to GPIO ports on the Super I/O chipset. The DIO has both 8-bit digital inputs and 8-bit digital outputs. The digital inputs and digital outputs are generally control signals that control the on/off circuit of external devices or TTL devices. Data can be read or written to the selected address to enable the DIO functions.



NOTE:

For further information, please refer to the datasheet for the Super I/O chipset.

The BIOS interrupt call **INT 15H** controls the digital I/O.

INT 15H:

AH – 6FH	
<u>Sub-function:</u>	
AL – 8	: Set the digital port as INPUT
AL	: Digital I/O input value

Assembly Language Sample 1

```

MOV     AX, 6F08H      ; setting the digital port as input
INT     15H           ;
    
```

AL low byte = value

ICE-BDE-T7 COM Express Module

AH – 6FH	
<u>Sub-function:</u>	
AL – 9	: Set the digital port as OUTPUT
BL	: Digital I/O output value

Assembly Language Sample 2

```
MOV    AX, 6F09H      ; setting the digital port as output  
MOV    BL, 09H        ; digital value is 09H  
INT    15H           ;
```

Digital Output is 1001b

Appendix

E

Watchdog Timer

ICE-BDE-T7 COM Express Module



NOTE:

The following discussion applies to DOS environment. Contact IEI support or visit the IEI website for specific drivers for other operating systems.

The Watchdog Timer is provided to ensure that standalone systems can always recover from catastrophic conditions that cause the CPU to crash. This condition may have occurred by external EMIs or a software bug. When the CPU stops working correctly, Watchdog Timer either performs a hardware reset (cold boot) or a Non-Maskable Interrupt (NMI) to bring the system back to a known state.

A BIOS function call (INT 15H) is used to control the Watchdog Timer.

INT 15H:

AH – 6FH Sub-function:	
AL – 2:	Sets the Watchdog Timer's period.
BL:	Time-out value (Its unit-second is dependent on the item "Watchdog Timer unit select" in CMOS setup).

Table E-1: AH-6FH Sub-function

Call sub-function 2 to set the time-out period of Watchdog Timer first. If the time-out value is not zero, the Watchdog Timer starts counting down. When the timer value reaches zero, the system resets. To ensure that this reset condition does not occur, calling sub-function 2 must periodically refresh the Watchdog Timer. However, the watchdog timer is disabled if the time-out value is set to zero.

A tolerance of at least 10% must be maintained to avoid unknown routines within the operating system (DOS), such as disk I/O that can be very time-consuming.

**NOTE:**

When exiting a program it is necessary to disable the Watchdog Timer, otherwise the system resets.

EXAMPLE PROGRAM:

```
; INITIAL TIMER PERIOD COUNTER
```

```
;
```

```
W_LOOP:
```

```
;
```

```
    MOV     AX, 6F02H      ;setting the time-out value  
    MOV     BL, 30        ;time-out value is 48 seconds  
    INT     15H
```

```
;
```

```
; ADD THE APPLICATION PROGRAM HERE
```

```
;
```

```
    CMP     EXIT_AP, 1    ;is the application over?  
    JNE     W_LOOP       ;No, restart the application
```

```
    MOV     AX, 6F02H     ;disable Watchdog Timer  
    MOV     BL, 0        ;  
    INT     15H
```

```
;
```

```
; EXIT ;
```

Appendix

F

Hazardous Materials Disclosure

The details provided in this appendix are to ensure that the product is compliant with the People’s Republic of China (China) RoHS standards. The table below acknowledges the presences of small quantities of certain materials in the product, and is applicable to China RoHS only.

A label will be placed on each product to indicate the estimated “Environmentally Friendly Use Period” (EFUP). This is an estimate of the number of years that these substances would “not leak out or undergo abrupt change.” This product may contain replaceable sub-assemblies/components which have a shorter EFUP such as batteries and lamps. These components will be separately marked.

Please refer to the following table.

Part Name	Toxic or Hazardous Substances and Elements					
	Lead (Pb)	Mercury (Hg)	Cadmium (Cd)	Hexavalent Chromium (CR(VI))	Polybrominated Biphenyls (PBB)	Polybrominated Diphenyl Ethers (PBDE)
Housing	O	O	O	O	O	O
Display	O	O	O	O	O	O
Printed Circuit Board	O	O	O	O	O	O
Metal Fasteners	O	O	O	O	O	O
Cable Assembly	O	O	O	O	O	O
Fan Assembly	O	O	O	O	O	O
Power Supply Assemblies	O	O	O	O	O	O
Battery	O	O	O	O	O	O

O: This toxic or hazardous substance is contained in all of the homogeneous materials for the part is below the limit requirement in SJ/T11363-2006 (now replaced by GB/T 26572-2011).

X: This toxic or hazardous substance is contained in at least one of the homogeneous materials for this part is above the limit requirement in SJ/T11363-2006 (now replaced by GB/T 26572-2011).

ICE-BDE-T7 COM Express Module

此附件旨在确保本产品符合中国 RoHS 标准。以下表格标示此产品中某有毒物质的含量符合中国 RoHS 标准规定的限量要求。

本产品上会附有“环境友好使用期限”的标签，此期限是估算这些物质“不会有泄漏或突变”的年限。本产品可能包含有较短的环境友好使用期限的可替换元件，像是电池或灯管，这些元件将会单独标示出来。

部件名称	有毒有害物质或元素					
	铅 (Pb)	汞 (Hg)	镉 (Cd)	六价铬 (CR(VI))	多溴联苯 (PBB)	多溴二苯 醚 (PBDE)
壳体	○	○	○	○	○	○
显示	○	○	○	○	○	○
印刷电路板	○	○	○	○	○	○
金属螺帽	○	○	○	○	○	○
电缆组装	○	○	○	○	○	○
风扇组装	○	○	○	○	○	○
电力供应组装	○	○	○	○	○	○
电池	○	○	○	○	○	○

○: 表示该有毒有害物质在该部件所有物质材料中的含量均在 SJ/T 11363-2006 (现由 GB/T 26572-2011 取代) 标准规定的限量要求以下。

X: 表示该有毒有害物质至少在该部件的某一均质材料中的含量超出 SJ/T 11363-2006 (现由 GB/T 26572-2011 取代) 标准规定的限量要求。