

**MODEL:
WSB-BT**

Full-Size PICMG 1.0 CPU Card with 22nm Intel® Celeron® SoC, Dual Intel® PCIe GbE, VGA, iDP, LVDS, USB 3.1 Gen 1, PCIe Mini, mSATA, SATA 3Gb/s, COM, HD Audio and RoHS

User Manual

Revision

Date	Version	Changes
March 21, 2019	1.01	Modify Section 3.2.17: LVDS Connector
May 14, 2018	1.00	Initial release

Copyright

COPYRIGHT NOTICE

The information in this document is subject to change without prior notice in order to improve reliability, design and function and does not represent a commitment on the part of the manufacturer.

In no event will the manufacturer be liable for direct, indirect, special, incidental, or consequential damages arising out of the use or inability to use the product or documentation, even if advised of the possibility of such damages.

This document contains proprietary information protected by copyright. All rights are reserved. No part of this manual may be reproduced by any mechanical, electronic, or other means in any form without prior written permission of the manufacturer.

TRADEMARKS

All registered trademarks and product names mentioned herein are used for identification purposes only and may be trademarks and/or registered trademarks of their respective owners.

Manual Conventions

**WARNING**

Warnings appear where overlooked details may cause damage to the equipment or result in personal injury. Warnings should be taken seriously.

**CAUTION**

Cautionary messages should be heeded to help reduce the chance of losing data or damaging the product.

**NOTE**

These messages inform the reader of essential but non-critical information. These messages should be read carefully as any directions or instructions contained therein can help avoid making mistakes.

Table of Contents

1 INTRODUCTION.....	1
1.1 INTRODUCTION.....	2
1.2 MODEL VARIATIONS	2
1.3 FEATURES.....	3
1.4 CONNECTORS	4
1.5 DIMENSIONS.....	5
1.6 DATA FLOW	6
1.7 TECHNICAL SPECIFICATIONS	7
2 PACKING LIST.....	10
2.1 ANTI-STATIC PRECAUTIONS	11
2.2 UNPACKING PRECAUTIONS.....	11
2.3 PACKING LIST.....	12
2.4 OPTIONAL ITEMS	13
3 CONNECTORS	15
3.1 PERIPHERAL INTERFACE CONNECTORS.....	16
3.1.1 <i>WSB-BT Layout</i>	16
3.1.2 <i>Peripheral Interface Connectors</i>	16
3.1.3 <i>External Interface Panel Connectors</i>	18
3.2 INTERNAL PERIPHERAL CONNECTORS	18
3.2.1 <i>ATX Power Supply Enabled Connector</i>	18
3.2.2 <i>Audio Connector</i>	19
3.2.3 <i>Backlight Inverter Connector</i>	20
3.2.4 <i>Battery Connector</i>	21
3.2.5 <i>CPU 12 V Power Connector</i>	22
3.2.6 <i>Chassis Intrusion Connector</i>	23
3.2.7 <i>CompactFlash® Slot</i>	24
3.2.8 <i>Digital I/O Connector</i>	25
3.2.9 <i>EC Debug Connector</i>	26

3.2.10 Fan Connector (CPU).....	27
3.2.11 Fan Connectors (System).....	28
3.2.12 Front Panel Connector	29
3.2.13 $\overset{P}{C}$ Connector.....	30
3.2.14 Internal DisplayPort Connector	31
3.2.15 Keyboard and Mouse Connector	32
3.2.16 LAN LED Connectors	33
3.2.17 LVDS Connector	34
3.2.18 mSATA Slot.....	35
3.2.19 Parallel Port Connector	37
3.2.20 PCIe Mini Slot.....	38
3.2.21 SATA 3Gb/s Drive Connectors.....	39
3.2.22 Serial Port Connectors, RS-232/422/485	41
3.2.23 Serial Port Connectors, RS-232.....	42
3.2.24 SMBus Connector	43
3.2.25 SO-DIMM Slot.....	44
3.2.26 SPI Flash Connector.....	44
3.2.27 SPI Flash Connector, EC.....	45
3.2.28 TPM Connector.....	46
3.2.29 USB 2.0 Connector (Type A).....	47
3.2.30 USB 2.0 Connectors.....	48
3.3 EXTERNAL PERIPHERAL INTERFACE CONNECTOR PANEL	49
3.3.1 Ethernet Connectors	49
3.3.2 USB 2.0 Connector	50
3.3.3 USB 3.1 Gen 1 Connector.....	50
3.3.4 VGA Connector.....	51
4 INSTALLATION	52
4.1 ANTI-STATIC PRECAUTIONS	53
4.2 INSTALLATION CONSIDERATIONS.....	53
4.3 SO-DIMM INSTALLATION	55
4.4 HALF-SIZE PCIe MINI CARD INSTALLATION.....	56
4.5 FULL-SIZE PCIe MINI CARD INSTALLATION.....	58
4.6 mSATA MODULE INSTALLATION	60
4.7 COMPACTFLASH® INSTALLATION	62

WSB-BT CPU Card

4.8 SYSTEM CONFIGURATION.....	63
4.8.1 AT/ATX Power Mode Setting	63
4.8.2 Clear CMOS Button.....	64
4.8.3 LVDS Voltage Selection	65
4.9 INTERNAL PERIPHERAL DEVICE CONNECTIONS.....	66
4.9.1 SATA Drive Connection	66
4.10 OS INSTALLATION	67
5 BIOS.....	69
5.1 INTRODUCTION.....	70
5.1.1 Starting Setup.....	70
5.1.2 Using Setup	70
5.1.3 Getting Help.....	71
5.1.4 Unable to Reboot after Configuration Changes	71
5.1.5 BIOS Menu Bar.....	71
5.2 MAIN.....	72
5.3 ADVANCED.....	73
5.3.1 Trusted Computing	74
5.3.2 F81866 Super IO Configuration	75
5.3.2.1 Serial Port n Configuration	75
5.3.2.2 Parallel Port Configuration	82
5.3.3 iWDD H/W Monitor.....	84
5.3.3.1 Smart Fan Mode Configuration	85
5.3.4 Serial Port Console Redirection	86
5.3.5 iEi Feature	89
5.3.6 CPU Configuration	90
5.3.7 IDE Configuration.....	91
5.3.8 USB Configuration.....	92
5.4 CHIPSET	93
5.4.1 North Bridge	94
5.4.1.1 Intel IGD Configuration.....	95
5.4.2 South Bridge.....	97
5.4.2.1 PCI Express Configuration	98
5.5 SECURITY.....	99
5.6 BOOT.....	100

5.7 SAVE & EXIT	102
6 SOFTWARE DRIVERS	104
6.1 AVAILABLE DRIVERS	105
6.2 DRIVER DOWNLOAD	105
A REGULATORY COMPLIANCE	108
B PRODUCT DISPOSAL	110
C BIOS OPTIONS	112
D DIGITAL I/O INTERFACE.....	115
D.1 INTRODUCTION.....	116
D.2 ASSEMBLY LANGUAGE SAMPLE 1.....	117
D.3 ASSEMBLY LANGUAGE SAMPLE 2.....	117
E WATCHDOG TIMER.....	118
F HAZARDOUS MATERIALS DISCLOSURE.....	121

List of Figures

Figure 1-1: WSB-BT CPU Card	2
Figure 1-2: Connectors	4
Figure 1-3: WSB-BT Dimensions (mm).....	5
Figure 1-4: Data Flow Diagram.....	6
Figure 3-1: Peripheral Interface Connectors	16
Figure 3-2: ATX Power Supply Enabled Connector Location.....	18
Figure 3-3: Audio Connector Location	19
Figure 3-4: Backlight Inverter Connector Location.....	20
Figure 3-5: Battery Connector Location.....	21
Figure 3-6: CPU Power Connector Location.....	22
Figure 3-7: Chassis Intrusion Connector Location.....	23
Figure 3-8: CF Type II Slot Location	24
Figure 3-9: Digital I/O Connector Location	25
Figure 3-10: EC Debug Connector Location.....	26
Figure 3-11: CPU Fan Connector Location	27
Figure 3-12: System Fan Connector Location.....	28
Figure 3-13: Front Panel Connector Location	29
Figure 3-14: I ² C Connector Location	30
Figure 3-15: Internal DisplayPort Connector Location	31
Figure 3-16: Keyboard and Mouse Connector Location.....	32
Figure 3-17: LAN LED Connector Locations	33
Figure 3-18: LVDS Connector Location.....	34
Figure 3-19: mSATA Slot Location	36
Figure 3-20: Parallel Port Connector Location	37
Figure 3-21: PCIe Mini Slot Location	38
Figure 3-22: SATA 3Gb/s Drive Connector Locations	40
Figure 3-23: RS-232/422/485 Connector Locations.....	41
Figure 3-24: RS-232 Serial Port Connector Locations.....	42
Figure 3-25: SMBus Connector Location	43
Figure 3-26: SO-DIMM Slot Location	44

Figure 3-27: SPI Flash Connector Location.....	44
Figure 3-28: SPI EC Flash Connector Location.....	45
Figure 3-29: TPM Connector Location.....	46
Figure 3-30: USB 2.0 Connector (Type A) Location.....	47
Figure 3-31: USB 2.0 Connector Locations	48
Figure 3-32: External Peripheral Interface Connector	49
Figure 3-33: Ethernet Connector.....	50
Figure 3-34: VGA Connector	51
Figure 4-1: SO-DIMM Installation	55
Figure 4-2: Removing the Retention Screw	56
Figure 4-3: Inserting the Half-size PCIe Mini Card into the Slot at an Angle.....	57
Figure 4-4: Securing the Half-size PCIe Mini Card	57
Figure 4-5: Removing the Retention Screw and the Standoff	58
Figure 4-6: Installing the Standoff	59
Figure 4-7: Inserting the Full-size PCIe Mini Card into the Slot at an Angle	59
Figure 4-8: Securing the Full-size PCIe Mini Card	60
Figure 4-9: Removing the Retention Screw for the mSATA Module.....	61
Figure 4-10: Inserting the mSATA Module into the Socket at an Angle	61
Figure 4-11: Securing the mSATA Module.....	62
Figure 4-12: CompactFlash® Card Installation	63
Figure 4-13: AT/ATX Power Mode Switch Location	63
Figure 4-14: Clear CMOS Button Location.....	64
Figure 4-15: LVDS Voltage Selection Jumper Location	65
Figure 4-16: SATA Drive Cable Connection.....	66
Figure 4-17: SATA Power Drive Connection.....	67
Figure 4-18: BIOS Option–OS Selection	68
Figure 6-1: IEI Resource Download Center.....	105

List of Tables

Table 1-1: Model Variations	2
Table 1-2: WSB-BT Specifications	9
Table 2-1: Packing List.....	12
Table 2-2: Optional Items	14
Table 3-1: Peripheral Interface Connectors	17
Table 3-2: External Peripheral Connectors	18
Table 3-3: ATX Power Supply Enabled Connector Pinouts	19
Table 3-4: AT/ATX Power Mode Setting	19
Table 3-5: Audio Connector Pinouts	20
Table 3-6: Backlight Inverter Connector Pinouts	20
Table 3-7: Battery Connector Pinouts	22
Table 3-8: CPU Power Connector Pinouts	22
Table 3-9: Chassis Intrusion Connector Pinouts	23
Table 3-10: Digital I/O Connector Pinouts.....	25
Table 3-11: EC Debug Connector Pinouts	26
Table 3-12: CPU Fan Connector Pinouts	27
Table 3-13: System Fan Connector Pinouts	28
Table 3-14: Front Panel Connector Pinouts.....	29
Table 3-15: I ² C Connector Pinouts.....	30
Table 3-16: Internal DisplayPort Connector Pinouts	31
Table 3-17: Keyboard and Mouse Connector Pinouts	32
Table 3-18: LAN1 LED Connector (LED_LAN1) Pinouts.....	33
Table 3-19: LAN2 LED Connector (LED_LAN2) Pinouts.....	33
Table 3-20: LVDS Connector Pinouts.....	35
Table 3-21: mSATA Slot Pinouts.....	37
Table 3-22: Parallel Port Connector Pinouts	38
Table 3-23: PCIe Mini Slot Pinouts.....	39
Table 3-24: SATA 3Gb/s Drive Connector Pinouts.....	40
Table 3-25: RS-232/422/485 Connector Pinouts	41
Table 3-26: DB-9 RS-422/485 Pinouts.....	42

Table 3-27: RS-232 Serial Port Connector Pinouts	42
Table 3-28: SMBus Connector Pinouts	43
Table 3-29: SPI Flash Connector Pinouts	45
Table 3-30: SPI EC Flash Connector Pinouts	45
Table 3-31: TPM Connector Pinouts	46
Table 3-32: USB 2.0 Connector (Type A) Pinouts	47
Table 3-33: USB 2.0 Connector Pinouts.....	48
Table 3-34: LAN Pinouts	49
Table 3-35: USB 2.0 Port Pinouts.....	50
Table 3-36: USB 3.1 Gen 1 Port Pinouts.....	51
Table 3-37: VGA Connector Pinouts.....	51
Table 4-1: AT/ATX Power Mode Switch Settings.....	64
Table 4-2: LVDS Voltage Selection Jumper Settings.....	65
Table 5-1: BIOS Navigation Keys	71

BIOS Menus

BIOS Menu 1: Main	72
BIOS Menu 2: Advanced	73
BIOS Menu 3: Trusted Computing	74
BIOS Menu 4: F81866 Super IO Configuration	75
BIOS Menu 5: Serial Port n Configuration Menu	75
BIOS Menu 6: Parallel Port Configuration Menu	82
BIOS Menu 7: iWDD H/W Monitor	84
BIOS Menu 8: Smart Fan Mode Configuration	85
BIOS Menu 9: Serial Port Console Redirection	86
BIOS Menu 10: iEi Feature	89
BIOS Menu 11: CPU Configuration	90
BIOS Menu 12: IDE Configuration	91
BIOS Menu 13: USB Configuration	92
BIOS Menu 14: Chipset	94
BIOS Menu 15: North Bridge	94
BIOS Menu 16: Intel IGD Configuration	95
BIOS Menu 17: South Bridge	97
BIOS Menu 18: PCI Express Configuration	98
BIOS Menu 19: Security	99
BIOS Menu 20: Boot	100
BIOS Menu 21: Save & Exit	102

Chapter

1

Introduction

1.1 Introduction

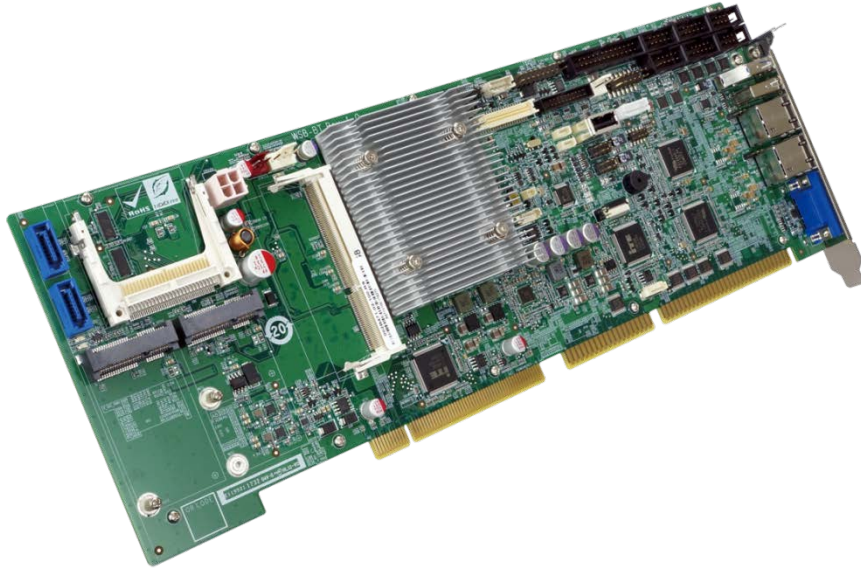

Figure 1-1: WSB-BT CPU Card

The WSB-BT full-size PICMG 1.0 CPU card is a 22nm Intel® Celeron® SoC platform with a DDR3L SO-DIMM socket and dual PCI Express (PCIe) Gigabit Ethernet (GbE). The WSB-BT equips with one USB 3.1 Gen 1, six USB 2.0, two SATA 3Gb/s, two RS-232/422/485, four RS-232, one PCIe Mini slot, one mSATA slot and one CF Type II slot, providing extreme expansion possibility. Moreover, multiple display support (VGA, iDP and optional LVDS) adds versatility to the system, enabling system integrators and designers increased flexibility in selecting display panel options.

1.2 Model Variations

The model variations for the WSB-BT series are listed in **Table 1-1**.

Model	On-board SoC				
	Name	Clock Speed	# of Cores	L2 Cache	Max TDP
WSB-BT-J1900	Intel® Celeron® J1900	2.00 GHz	4	2 MB	10 W
WSB-BT-N2807	Intel® Celeron® N2807	1.58 GHz	2	2 MB	4.3 W

Table 1-1: Model Variations

WSB-BT CPU Card

1.3 Features

Some of the WSB-BT motherboard features are listed below:

- Full-size PICMG 1.0 CPU card
- On-board 22nm Intel® Celeron® J1900 or N2807 SoC
- One 204-pin 1333/1066 MHz dual-channel unbuffered DDR3L SDRAM SO-DIMM slot supports up to 8 GB (J1900) or 4 GB (N2807)
- Dual Intel® PCIe GbE
- Multiple display outputs by VGA, iDP or 18/24-bit LVDS interfaces
- Complete I/O interfaces, including one USB 3.1 Gen 1, six USB 2.0, four RS-232, two RS-232/422/485 and two SATA 3Gb/s
- Flexible expansion options, including one CF Type II slot, one mSATA slot and one PCIe Mini slot
- TPM v1.2/v2.0 hardware security function supported by TPM module
- High Definition Audio
- RoHS compliant

1.4 Connectors

The connectors on the WSB-BT are shown in the figure below.

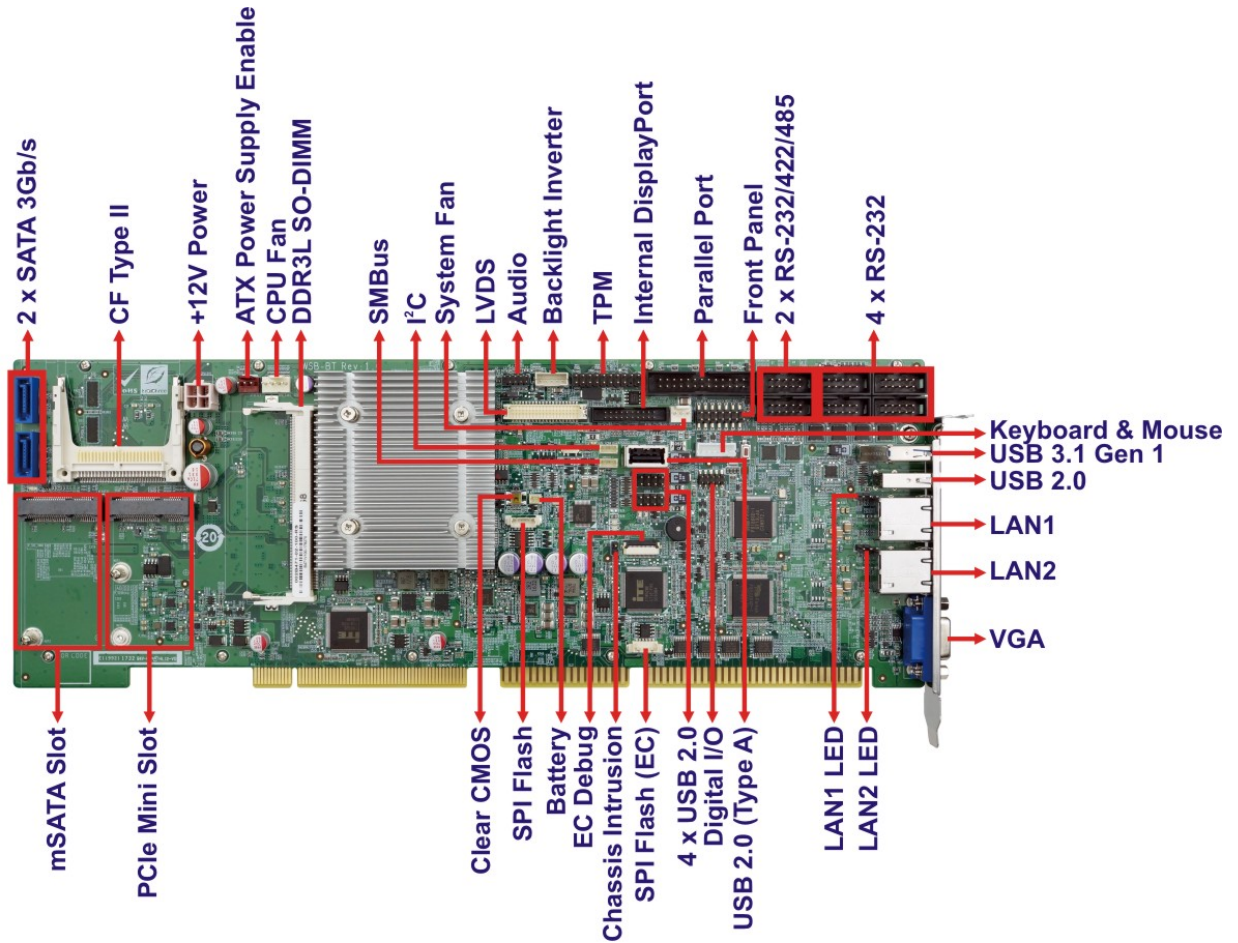

Figure 1-2: Connectors

WSB-BT CPU Card

1.5 Dimensions

The main dimensions of the WSB-BT are shown in the diagram below.

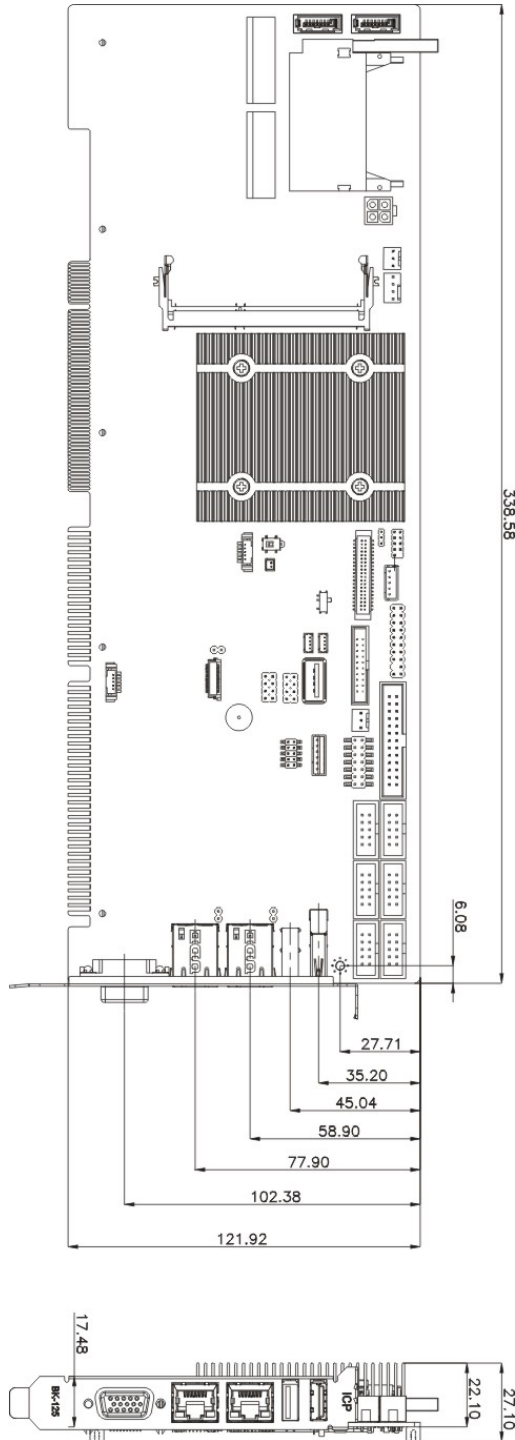

Figure 1-3: WSB-BT Dimensions (mm)

1.6 Data Flow

Figure 1-4 shows the data flow between the system chipset, the CPU and other components installed on the motherboard.

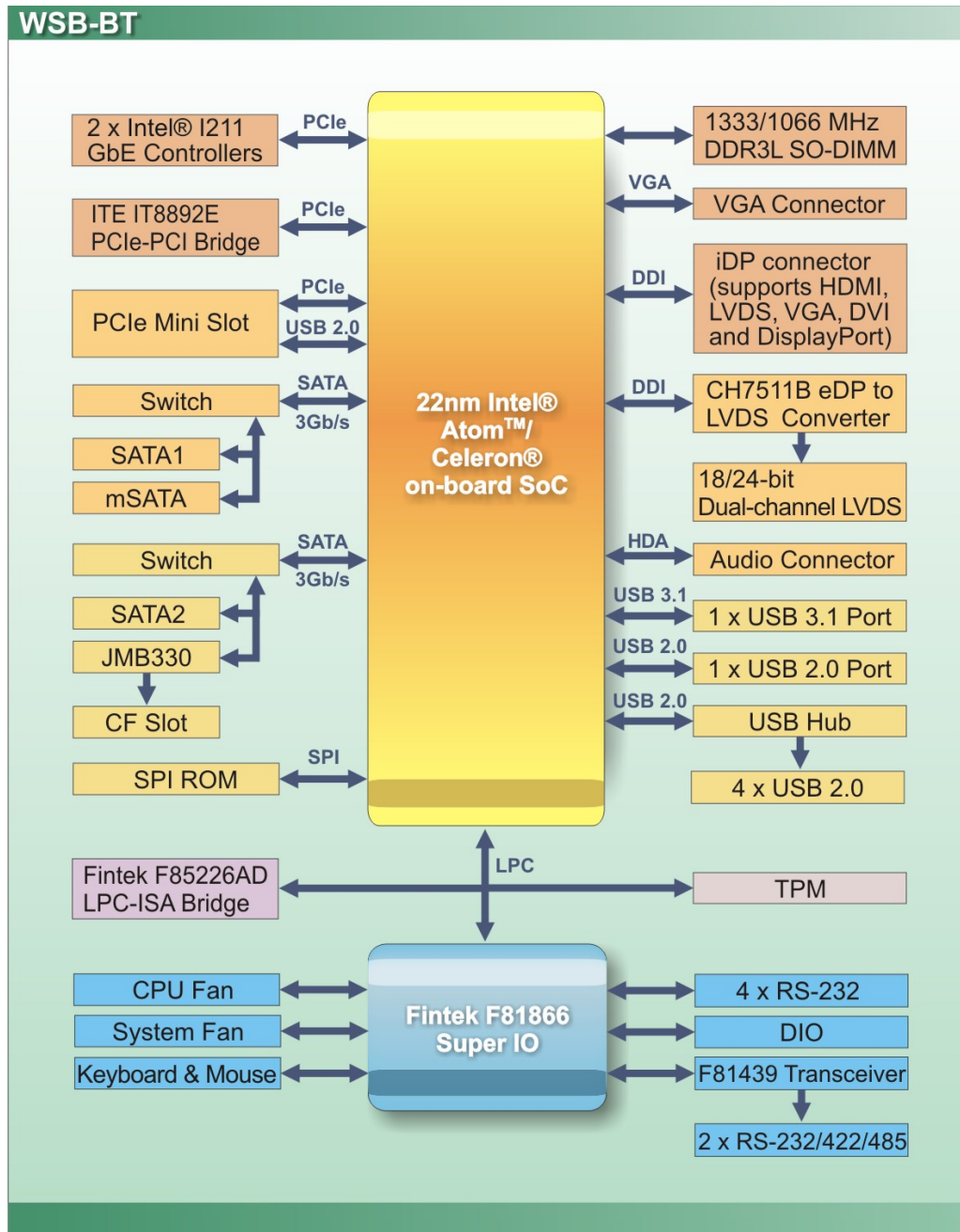

Figure 1-4: Data Flow Diagram

WSB-BT CPU Card

1.7 Technical Specifications

The WSB-BT technical specifications are listed below.

Specification/Model	WSB-BT
Form Factor	Full-size PICMG 1.0 CPU card
On-board SoC	Intel® Celeron® J1900 (2GHz, quad-core, 2MB cache, TDP=10W) Intel® Celeron® N2807 (1.58GHz, dual-core, 2MB cache, TDP=4.3W)
Memory	One 240-pin 1333/1066 MHz dual-channel unbuffered DDR3L SDRAM SO-DIMM slot supports up to 8 GB (J1900) or 4 GB (N2807)
Graphics Engine	Intel® HD Graphics Gen 7 with 4 execution units, supporting DirectX 11.1, OpenCL 1.2 and OpenGL 4.2
Display Output	One VGA (up to 1920x1200@60 Hz) One iDP interface for HDMI, LVDS, VGA, DVI and DisplayPort (up to 2560x1600@60 Hz) One 18/24-bit dual-channel LVDS (up to 1920x1200@60 Hz)
Ethernet	Two Intel® I211-AT PCIe GbE controllers
Audio	Supports 7.1-channel HD audio by IEI AC-KIT-892HD kit One audio connector (10-pin header)
Expansion	One mSATA slot (SATA 3Gb/s, shares with SATA1 port) One CF Type II slot (shares with SATA2 port) One PCIe Mini slot (full-size/half-size) PCIe-PCI bridge: ITE IT8892E LPC-ISA bridge: Fintek F85226AD PCI and ISA* signal via golden finger * The ISA function is limited. Please refer to page 9 for details.
Super I/O Controller	Fintek F81866
Watchdog Timer	Software programmable supports 1~255 sec. system reset
BIOS	UEFI BIOS
External I/O Interface Connectors	
Display Output	One VGA connector

Ethernet	Two RJ-45 ports
USB	One USB 3.1 Gen 1 (5 Gb/s) port One USB 2.0 port
Internal I/O Interface Connectors	
Audio Connector	One audio connector (10-pin header)
Digital I/O	8-bit digital I/O
Fan	One 4-pin CPU smart fan connector One 3-pin system smart fan connector
Front Panel	One 14-pin header (power LED, HDD LED, speaker, power button, reset button)
I²C	One 4-pin wafer connector
Internal DisplayPort	One 20-pin box header
Keyboard and Mouse	One internal keyboard and mouse connector (6-pin wafer)
Parallel Port	One parallel port via internal 26-pin box header
Serial ATA	Two SATA 3Gb/s connectors
Serial Ports	Two RS-232/422/485 via internal 10-pin box headers Four RS-232 via internal 10-pin box headers
SMBus	One 4-pin wafer connector
TPM	One via 20-pin header
USB	Four USB 2.0 ports by two internal pin headers One USB 2.0 port by internal Type A connector
Environmental and Power Specifications	
Power Supply	5V/12V, AT/ATX power support
Power Consumption	5V@4.68A, 12V@1.143A (1.99 GHz Intel® Celeron® J1900 CPU with 8 GB 1600 MHz DDR3L memory)
Operating Temperature	-20°C ~ 60°C
Storage Temperature	-30°C ~ 70°C
Operating Humidity	5% ~ 95% (non-condensing)

WSB-BT CPU Card

Safety	CE, FCC
Physical Specifications	
Dimensions	338 mm x 122 mm
Weight (GW/NW)	1000 g/260 g

Table 1-2: WSB-BT Specifications**NOTE:****ISA Limitation of WSB-BT**

Due to the limitation of Intel® Bay Trail processors, the WSB-BT does not support the following features:

- Bus Master Cycles
 - DMA
 - LPC Memory Mapped Transactions
 - IRQ0, IRQ1, IRQ2, IRQ8, IRQ9, IRQ13, IRQ14
 - ISA Enable (IE) Bit
 - PnP
-

Chapter

2

Packing List

WSB-BT CPU Card

2.1 Anti-static Precautions



WARNING!

Static electricity can destroy certain electronics. Make sure to follow the ESD precautions to prevent damage to the product, and injury to the user.

Make sure to adhere to the following guidelines:

- **Wear an anti-static wristband:** Wearing an anti-static wristband can prevent electrostatic discharge.
- **Self-grounding:** Touch a grounded conductor every few minutes to discharge any excess static buildup.
- **Use an anti-static pad:** When configuring any circuit board, place it on an anti-static mat.
- **Only handle the edges of the PCB:** Don't touch the surface of the motherboard. Hold the motherboard by the edges when handling.

2.2 Unpacking Precautions

When the WSB-BT is unpacked, please do the following:

- Follow the anti-static guidelines above.
- Make sure the packing box is facing upwards when opening.
- Make sure all the packing list items are present.

2.3 Packing List



NOTE:

If any of the components listed in the checklist below are missing, do not proceed with the installation. Contact the IEI reseller or vendor the WSB-BT was purchased from or contact an IEI sales representative directly by sending an email to sales@ieiworld.com.

The WSB-BT is shipped with the following components:











Quantity	Item and Part Number	Image
1	WSB-BT CPU card	
1	SATA cable	
1	Dual RS-232 cable with bracket	
1	Quick installation guide	

Table 2-1: Packing List

WSB-BT CPU Card

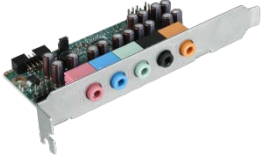
2.4 Optional Items

The following are optional components which may be separately purchased:

Item and Part Number	Image
PS/2 KB/MS Y-cable with bracket, 220 mm (P/N: 19800-000075-RS)	
SATA power cable (P/N: 32102-000100-200-RS)	
LPT cable (P/N: 19800-000049-RS)	
7.1-channel HD audio kit with Realtek ALC892 audio codec supporting dual audio stream (P/N: AC-KIT-892HD-R10)	
DisplayPort to HDMI converter board (for IEI iDP connector) (P/N: DP-HDMI-R10)	
DisplayPort to LVDS converter board (for IEI iDP connector) (P/N: DP-LVDS-R10)	
DisplayPort to VGA converter board (for IEI iDP connector) (P/N: DP-VGA-R10)	
DisplayPort to DVI-D converter board (for IEI iDP connector) (P/N: DP-DVI-R10)	

Item and Part Number	Image
DisplayPort to DisplayPort converter board (for IEI iDP connector) (P/N: DP-DP-R10)	
20-pin Infineon TPM 1.2 module, software management tool, firmware v3.17 (P/N: TPM-IN01-R20)	
20-pin Infineon TPM 2.0 module, software management tool, firmware v5.5 (P/N: TPM-IN02-R20)	

Table 2-2: Optional Items

Chapter

3

Connectors

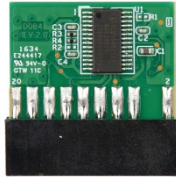
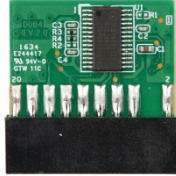
3.1 Peripheral Interface Connectors

This chapter details all the peripheral interface connectors.

3.1.1 WSB-BT Layout

The figure below shows all the peripheral interface connectors.

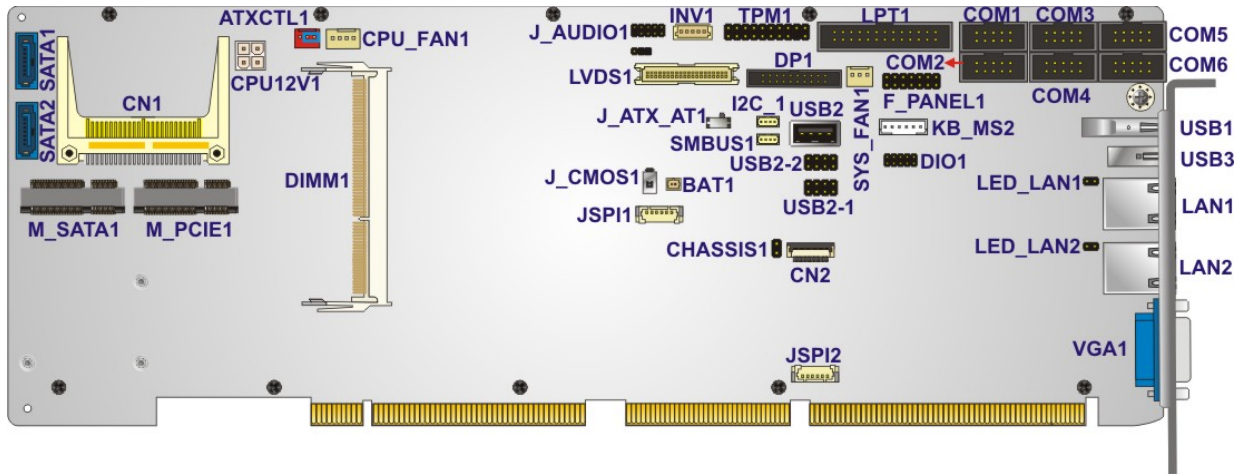

Figure 3-1: Peripheral Interface Connectors

3.1.2 Peripheral Interface Connectors

The table below lists all the connectors on the board.

Connector	Type	Label
ATX power supply enabled connector	3-pin wafer	ATXCTL1
Audio connector	10-pin header	J_AUDIO1
Backlight inverter connector	5-pin wafer	INV1
Battery connector	2-pin wafer	BAT1
CPU 12 V power connector	4-pin connector	CPU12V1
Chassis intrusion connector	2-pin header	CHASSIS1
CompactFlash® slot	CF Type II	CN1
Digital I/O connector	10-pin header	DIO1
EC debug connector	20-pin FPC	CN2

WSB-BT CPU Card

Connector	Type	Label
Fan connector (CPU)	4-pin wafer	CPU_FAN1
Fan connector (system)	3-pin wafer	SYS_FAN1
Front panel connector	14-pin header	F_PANEL1
I ² C connector	4-pin wafer	I2C_1
Internal DisplayPort connector	20-pin box header	DP1
Keyboard and mouse connector	6-pin wafer	KB_MS2
LAN LED connectors	2-pin header	LED_LAN1, LED_LAN2
LVDS connector	40-pin crimp	LVDS1
mSATA slot	Full-size PCIe Mini slot	M_SATA1
Parallel port connector	26-pin box header	LPT1
PCIe Mini slot	PCIe Mini slot	M_PCIE1
SATA 3Gb/s drive connector	7-pin SATA connector	SATA1, SATA2
Serial port, RS-232/422/485	10-pin box header	COM1, COM2
Serial port, RS-232	10-pin box header	COM3, COM4, COM5, COM6
SMBus connector	4-pin wafer	SMBUS1
SO-DIMM slot	240-pin DDR3L SO-DIMM slot	DIMM1
SPI flash connector	6-pin wafer	JSPI1
SPI flash connector, EC	6-pin wafer	JSPI2
TPM connector	20-pin header	TPM1
USB 2.0 connector (Type A)	Type A	USB2
USB 2.0 connectors	8-pin header	USB2-1, USB2-2

Table 3-1: Peripheral Interface Connectors

3.1.3 External Interface Panel Connectors

The table below lists the connectors on the external I/O panel.

Connector	Type	Label
Ethernet ports	RJ-45	LAN1, LAN2
USB 2.0 port	USB 2.0	USB3
USB 3.1 Gen 1 port	USB 3.1 Gen 1	USB1
VGA connector	15-pin female	VGA1

Table 3-2: External Peripheral Connectors

3.2 Internal Peripheral Connectors

The section describes all of the connectors on the WSB-BT.

3.2.1 ATX Power Supply Enabled Connector

- CN Label:** ATXCTL1
- CN Type:** 3-pin wafer, p=2.54 mm
- CN Location:** See **Figure 3-2**
- CN Pinouts:** See **Table 3-3**

The ATX power supply enabled connector enables the WSB-BT to be connected to an ATX power supply. Refer to **Table 3-4** for the configuration of AT/ATX power mode.

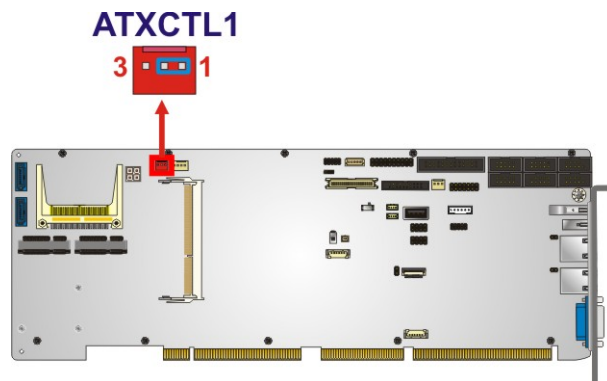

Figure 3-2: ATX Power Supply Enabled Connector Location

WSB-BT CPU Card

Pin	Description
1	GND
2	PS_ON#
3	5VSB

Table 3-3: ATX Power Supply Enabled Connector Pinouts

The AT/ATX power mode settings are listed below.

Setting	Description
AT Power Mode	Short 1-2 (Default)
ATX Power Mode	Connect PS_ON# and 5VSB cable from ATX power supply

Table 3-4: AT/ATX Power Mode Setting

3.2.2 Audio Connector

- CN Label:** J_AUDIO1
- CN Type:** 10-pin header, p=2.0 mm
- CN Location:** See **Figure 3-3**
- CN Pinouts:** See **Table 3-5**

This connector allows connection to an external audio kit.

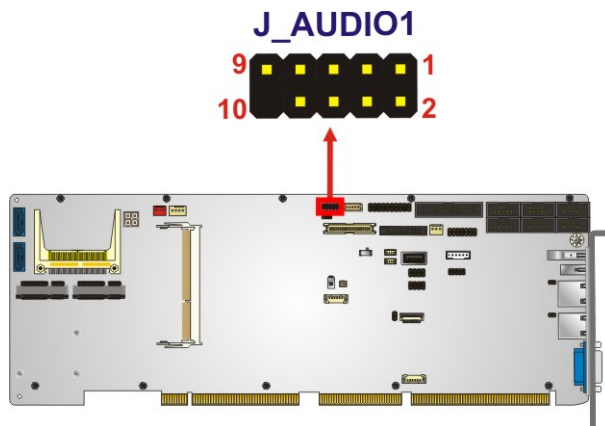

Figure 3-3: Audio Connector Location

Pin	Description	Pin	Description
1	HDA_SYNC	2	HDA_BIT_CLK
3	HDA_SDOUT	4	HDA_SPKR
5	HDA_SDIN	6	HDA_RST#
7	HDA_VCC	8	HDA_GND
9	HDA_+12V	10	HDA_GND

Table 3-5: Audio Connector Pinouts

3.2.3 Backlight Inverter Connector

- CN Label:** INV1
- CN Type:** 5-pin wafer, p=2.0 mm
- CN Location:** See **Figure 3-4**
- CN Pinouts:** See **Table 3-6**

The backlight inverter connector provides power to an LCD panel.

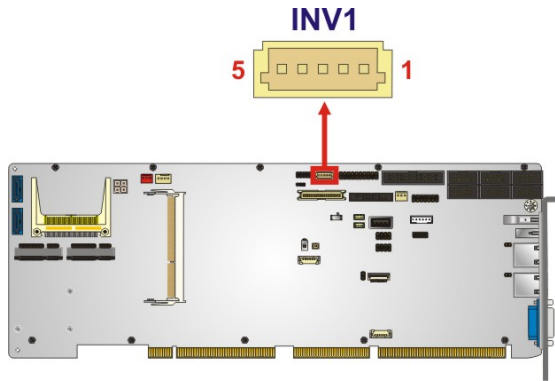

Figure 3-4: Backlight Inverter Connector Location

Pin	Description
1	LCD_BKLTCTL
2	GROUND
3	+12V
4	GROUND
5	BACKLIGHT ENABLE

Table 3-6: Backlight Inverter Connector Pinouts

WSB-BT CPU Card

3.2.4 Battery Connector



CAUTION:

Risk of explosion if battery is replaced by an incorrect type. Only certified engineers should replace the on-board battery.

Dispose of used batteries according to instructions and local regulations.



NOTE:

It is recommended to attach the RTC battery onto the system chassis in which the WSB-BT is installed.

CN Label:	BAT1
CN Type:	2-pin wafer, p=1.25 mm
CN Location:	See Figure 3-5
CN Pinouts:	See Table 3-7

This is connected to the system battery. The battery provides power to the system clock to retain the time when power is turned off.

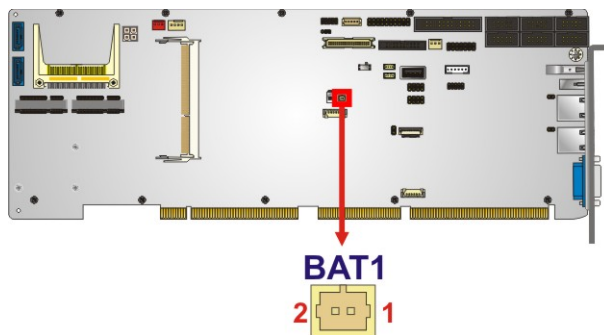

Figure 3-5: Battery Connector Location

Pin	Description
1	VBATT
2	GND

Table 3-7: Battery Connector Pinouts

3.2.5 CPU 12 V Power Connector

- CN Label:** CPU12V1
- CN Type:** 4-pin connector, p=4.2 mm
- CN Location:** See **Figure 3-6**
- CN Pinouts:** See **Table 3-8**

This connector accepts 12 V of power for the processor.

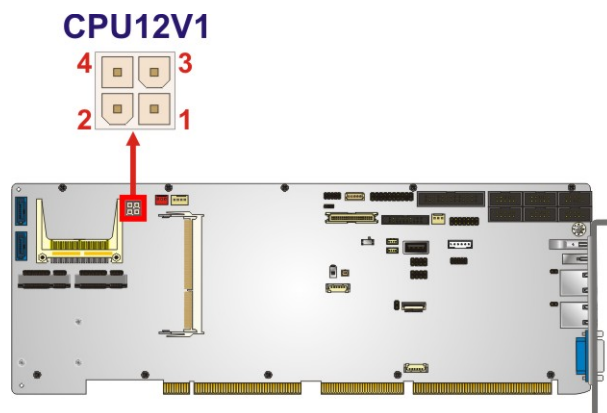

Figure 3-6: CPU Power Connector Location

Pin	Description	Pin	Description
1	GND	2	GND
3	+12 V	4	+12 V

Table 3-8: CPU Power Connector Pinouts

WSB-BT CPU Card

3.2.6 Chassis Intrusion Connector

- CN Label:** CHASSIS1
- CN Type:** 2-pin header, p=2.54 mm
- CN Location:** See **Figure 3-7**
- CN Pinouts:** See **Table 3-9**

The chassis intrusion connector is for a chassis intrusion detection sensor or switch that detects if a chassis component is removed or replaced.

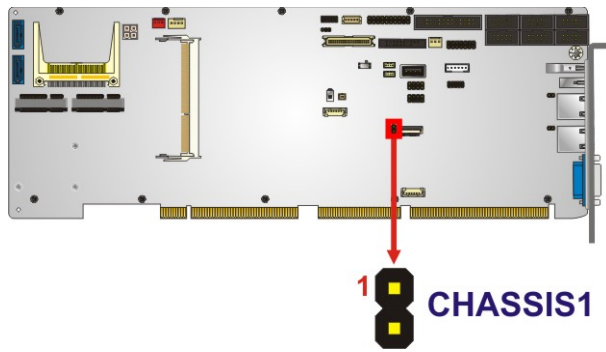

Figure 3-7: Chassis Intrusion Connector Location

Pin	Description
1	+3.3VSB
2	CHASSIS OPEN

Table 3-9: Chassis Intrusion Connector Pinouts

3.2.7 CompactFlash® Slot



NOTE:

The CompactFlash® card slot is disabled by default. Before the installation, please enable the CF slot by configuring the BIOS option (SATA CF Switch Setting). See **Section 5.4.2**.

- CN Label:** CN1
- CN Type:** CompactFlash Type II
- CN Location:** See **Figure 3-8**

A CompactFlash® Type I/II card can be used in this slot.

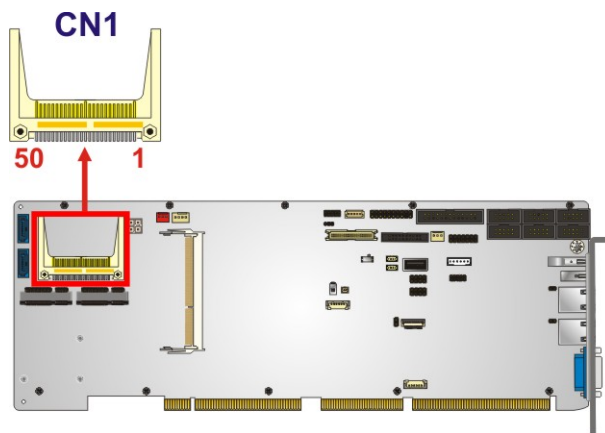

Figure 3-8: CF Type II Slot Location

WSB-BT CPU Card

3.2.8 Digital I/O Connector

- CN Label:** DIO1
- CN Type:** 10-pin header, p=2.0 mm
- CN Location:** See **Figure 3-9**
- CN Pinouts:** See **Table 3-10**

The digital I/O connector provides programmable input and output for external devices.

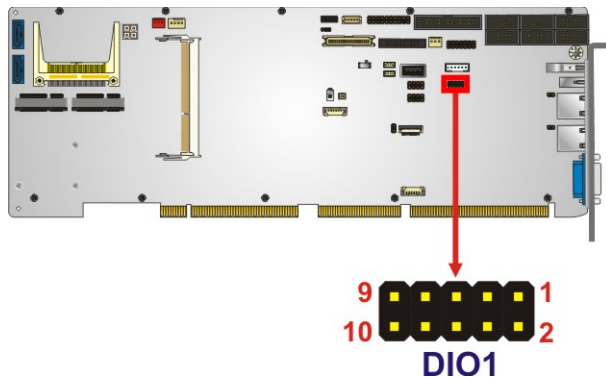

Figure 3-9: Digital I/O Connector Location

Pin	Description	Pin	Description
1	GND	2	VCC
3	Output 3	4	Output 2
5	Output 1	6	Output 0
7	Input 3	8	Input 2
9	Input 1	10	Input 0

Table 3-10: Digital I/O Connector Pinouts

3.2.9 EC Debug Connector

- CN Label:** CN2
- CN Type:** 20-pin FPC, p=0.5 mm
- CN Location:** See **Figure 3-10**
- CN Pinouts:** See **Table 3-11**

The EC debug connector is used for EC debug.

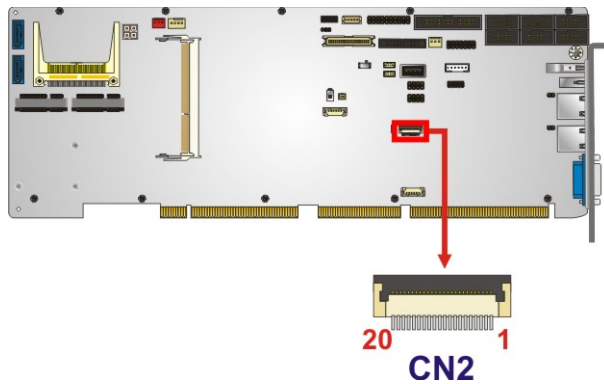

Figure 3-10: EC Debug Connector Location

Pin	Description	Pin	Description
1	KS10	2	KSO0
3	KSO1	4	KSO2
5	KSO3	6	KSO4
7	KSO5	8	KSO6
9	KSO7	10	KSO8
11	KSO9	12	KSO10
13	KSO12	14	KS11
15	KSO11	16	KS12
17	KS13	18	GND
19	GND	20	GND

Table 3-11: EC Debug Connector Pinouts

WSB-BT CPU Card

3.2.10 Fan Connector (CPU)

- CN Label:** CPU_FAN1
- CN Type:** 4-pin wafer, p=2.54 mm
- CN Location:** See **Figure 3-11**
- CN Pinouts:** See **Table 3-12**

The fan connector attaches to a CPU cooling fan.

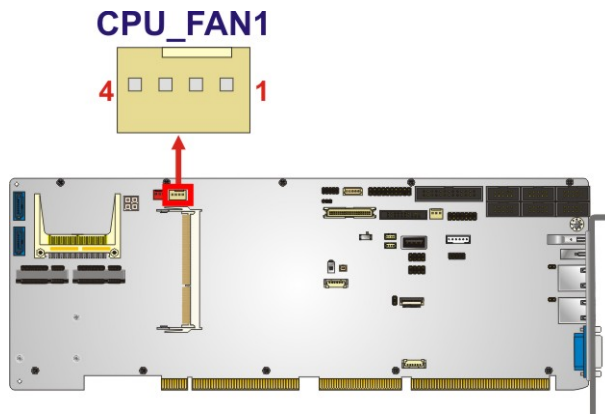

Figure 3-11: CPU Fan Connector Location

Pin	Description
1	GND
2	+12V
3	FANIO
4	PWM

Table 3-12: CPU Fan Connector Pinouts

3.2.11 Fan Connectors (System)

- CN Label:** **SYS_FAN1**
- CN Type:** 3-pin wafer, p=2.54 mm
- CN Location:** See **Figure 3-12**
- CN Pinouts:** See **Table 3-13**

Each fan connector attaches to a system cooling fan.

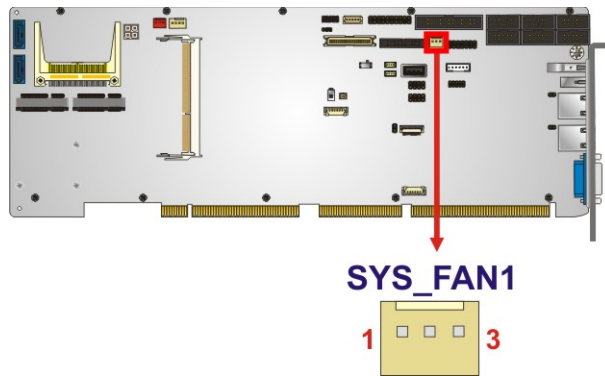

Figure 3-12: System Fan Connector Location

Pin	Description
1	FANIO
2	+12V
3	GND

Table 3-13: System Fan Connector Pinouts

WSB-BT CPU Card

3.2.12 Front Panel Connector

- CN Label:** F_PANEL1
- CN Type:** 14-pin header, p=2.54 mm
- CN Location:** See **Figure 3-13**
- CN Pinouts:** See **Table 3-14**

The front panel connector connects to the indicator LEDs and buttons on the computer's front panel.

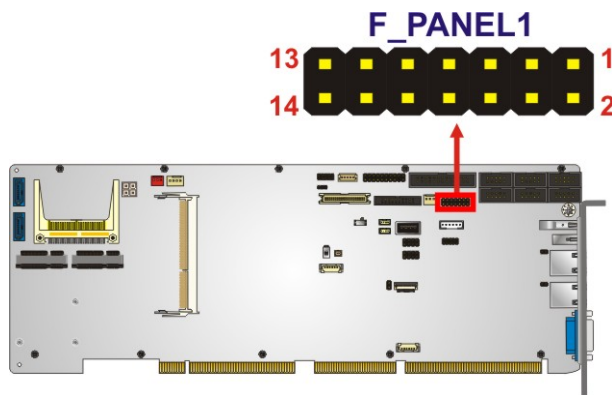

Figure 3-13: Front Panel Connector Location

Function	Pin	Description	Function	Pin	Description
Power LED	1	+5V	Buzzer	2	BEEP_PWR
	3	NC		4	NC
	5	GND		6	NC
Power Button	7	PWRBTN_SW#		8	PC_BEEP
	9	GND		10	NC
HDD LED	11	SATA_LED+	Reset	12	PM_SYSRST_R#
	13	SATA_LED#		14	GND

Table 3-14: Front Panel Connector Pinouts

3.2.13 I²C Connector

- CN Label:** I2C_1
- CN Type:** 4-pin wafer, p=1.25 mm
- CN Location:** See **Figure 3-14**
- CN Pinouts:** See **Table 3-15**

The I²C connector is used to connect I²C-bus devices to the motherboard.

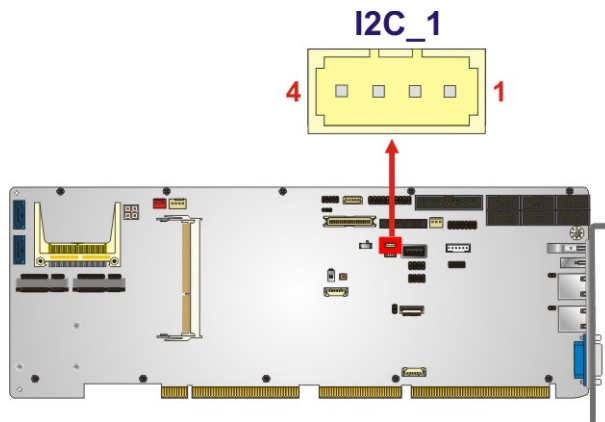

Figure 3-14: I²C Connector Location

Pin	Description
1	GND
2	PCH_GP38
3	PCH_GP39
4	+5V

Table 3-15: I²C Connector Pinouts

WSB-BT CPU Card

3.2.14 Internal DisplayPort Connector

- CN Label:** DP1
- CN Type:** 20-pin box header, p=2 mm
- CN Location:** See **Figure 3-15**
- CN Pinouts:** See **Table 3-16**

The DisplayPort connector supports HDMI, LVDS, VGA, DVI and DisplayPort graphics interfaces with up to 2560x1600@60Hz resolutions.

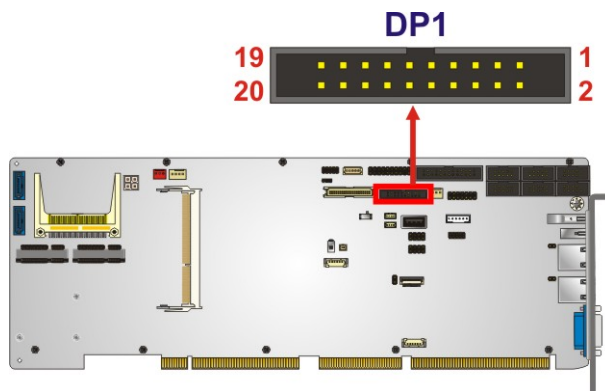

Figure 3-15: Internal DisplayPort Connector Location

Pin	Description	Pin	Description
1	HPD	2	AUX_CTRL_P2
3	GND	4	AUX_CTRL_N2
5	AUX_CTRL_DET_D	6	GND
7	GND	8	LANE2P
9	LANE3P	10	LANE2N
11	LANE3N	12	GND
13	GND	14	LANE0P
15	LANE1P	16	LANE0N
17	LANE1N	18	+3.3V
19	+5V	20	NC

Table 3-16: Internal DisplayPort Connector Pinouts

3.2.15 Keyboard and Mouse Connector

- CN Label:** KB_MS2
- CN Type:** 6-pin wafer, p=2.0 mm
- CN Location:** See **Figure 3-16**
- CN Pinouts:** See **Table 3-17**

The keyboard and mouse connector connects to a PS/2 Y-cable that can be connected to a PS/2 keyboard and mouse.

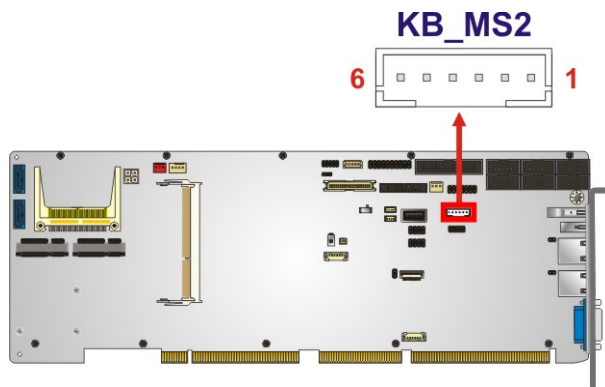

Figure 3-16: Keyboard and Mouse Connector Location

Pin	Description
1	VCC
2	Mouse Data
3	Mouse Clock
4	Keyboard Data
5	Keyboard Clock
6	GND

Table 3-17: Keyboard and Mouse Connector Pinouts

WSB-BT CPU Card

3.2.16 LAN LED Connectors

- CN Label:** LED_LAN1, LED_LAN2
- CN Type:** 2-pin header, p=2.54 mm
- CN Location:** See **Figure 3-17**
- CN Pinouts:** See **Table 3-18** and **Table 3-19**

The LAN LED connectors are used to connect to the LAN LED indicators on the chassis to indicate users the link activities of the two LAN ports.

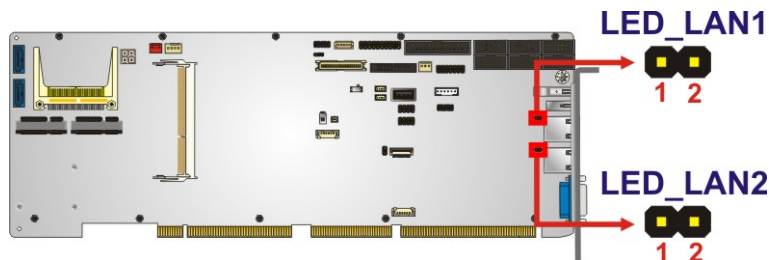

Figure 3-17: LAN LED Connector Locations

Pin	Description
1	+3.3V
2	LAN1_LED_LINK#_ACT

Table 3-18: LAN1 LED Connector (LED_LAN1) Pinouts

Pin	Description
1	+3.3V
2	LAN2_LED_LINK#_ACT

Table 3-19: LAN2 LED Connector (LED_LAN2) Pinouts

3.2.17 LVDS Connector



CAUTION:

Pin 33 on the LVDS cable must be **GROUND**; otherwise the system will not display through LVDS even the LVDS cable is connected to the WSB-BT.

- CN Label:** LVDS1
- CN Type:** 40-pin crimp, p=1.25 mm
- CN Location:** See **Figure 3-18**
- CN Pinouts:** See **Table 3-20**

The LVDS connector is for the LCD panel connected to the board.

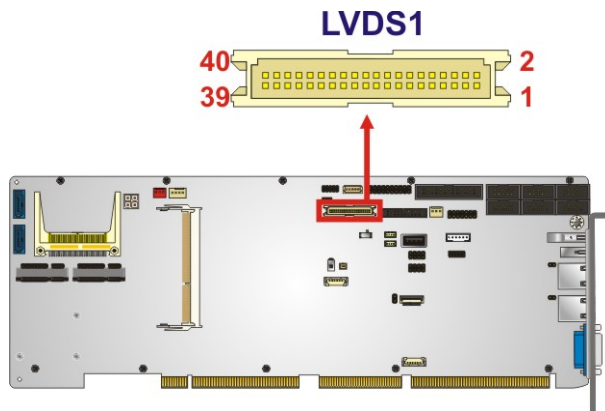

Figure 3-18: LVDS Connector Location

Pin	Description	Pin	Description
1	GND	2	GND
3	LVDS_DATA0	4	LVDS_DATA1#
5	LVDS_DATA0#	6	LVDS_DATA1
7	GND	8	GND
9	LVDS_DATA2#	10	LVDS_CLK1#
11	LVDS_DATA2	12	LVDS_CLK1
13	GND	14	GND

WSB-BT CPU Card

Pin	Description	Pin	Description
15	LVDS_DATA3#	16	LVDS_DATA4#
17	LVDS_DATA3	18	LVDS_DATA4
19	GND	20	GND
21	LVDS_DATA5#	22	LVDS_DATA6#
23	LVDS_DATA5	24	LVDS_DATA6
25	GND	26	GND
27	VCC_LCD	28	LVDS_DATA7#
29	VCC_LCD	30	LVDS_DATA7
31	GND	32	GND
33	LVDS Detect (GND)*	34	GND
35	VCC_LCD	36	VCC_LCD
37	VCC_LCD	38	VCC_LCD
39	VCC_LCD	40	VCC_LCD

*LVDS Detect must be connected to GND.

Table 3-20: LVDS Connector Pinouts

3.2.18 mSATA Slot



NOTE:

The user can use either the mSATA slot or the **SATA1** connector. If an mSATA device is installed to the mSATA slot, the **SATA1** connector will be disabled.

- CN Label:** M_SATA1
- CN Type:** PCIe Mini slot
- CN Location:** See **Figure 3-19**
- CN Pinouts:** See **Table 3-21**

The mSATA slot is for installing a full-size mSATA module.

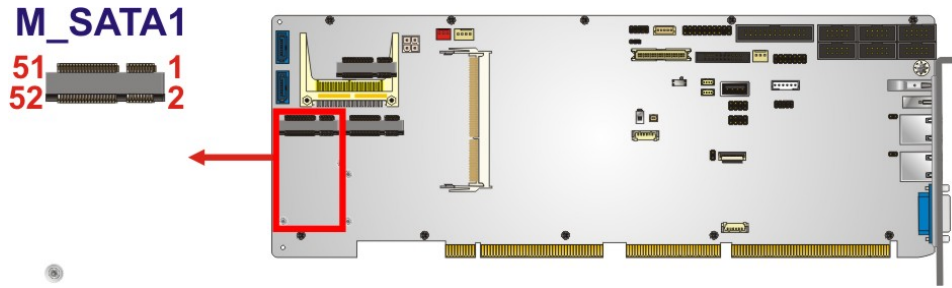

Figure 3-19: mSATA Slot Location

Pin	Description	Pin	Description
1	PCIE_WAKE#	2	+3.3V
3	N/C	4	GND
5	N/C	6	1.5V
7	N/C	8	N/C
9	GND	10	N/C
11	MSATA_CLK#	12	N/C
13	MSATA_CLK	14	N/C
15	GND	16	N/C
17	PLTRST_N	18	GND
19	N/C	20	+3.3V
21	GND	22	PLTRST_N
23	SATA_RX+	24	+3.3V
25	SATA_RX-	26	GND
27	GND	28	1.5V
29	GND	30	SMB_CLK
31	SATA_TX-	32	SMB_DATA
33	SATA_TX+	34	GND
35	GND	36	USB_DATA-
37	GND	38	USB_DATA+
39	+3.3V	40	GND
41	+3.3V	42	N/C
43	+3.3V	44	N/C
45	N/C	46	N/C
47	N/C	48	1.5V

WSB-BT CPU Card

Pin	Description	Pin	Description
49	N/C	50	GND
51	MSATA_DET	52	+3.3V

Table 3-21: mSATA Slot Pinouts

3.2.19 Parallel Port Connector

- CN Label:** LPT1
- CN Type:** 26-pin box header, p=2.54 mm
- CN Location:** See **Figure 3-20**
- CN Pinouts:** See **Table 3-22**

The parallel port connector connects to a parallel port connector interface or some other parallel port device such as a printer.

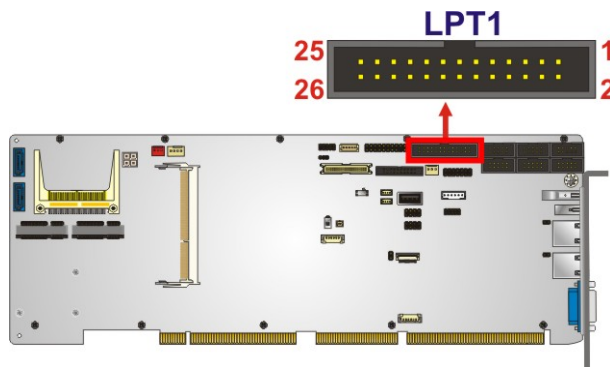

Figure 3-20: Parallel Port Connector Location

Pin	Description	Pin	Description
1	STROBE#	2	DATA0
3	DATA1	4	DATA2
5	DATA3	6	DATA4
7	DATA5	8	DATA6
9	DATA7	10	ACKNOWLEDGE#
11	BUSY	12	PAPER EMPTY
13	PRINTER SELECT	14	AUTO FORM FEED #
15	ERROR#	16	INITIALIZE#

Pin	Description	Pin	Description
17	PRINTER SELECT LN#	18	GND
19	GND	20	GND
21	GND	22	GND
23	GND	24	GND
25	GND		

Table 3-22: Parallel Port Connector Pinouts

3.2.20 PCIe Mini Slot

- CN Label:** M_PCIE1
- CN Type:** PCIe Mini slot
- CN Location:** See **Figure 3-21**
- CN Pinouts:** See **Table 3-23**

The PCIe Mini slot is for installing a full-size/half-size PCIe Mini expansion card.

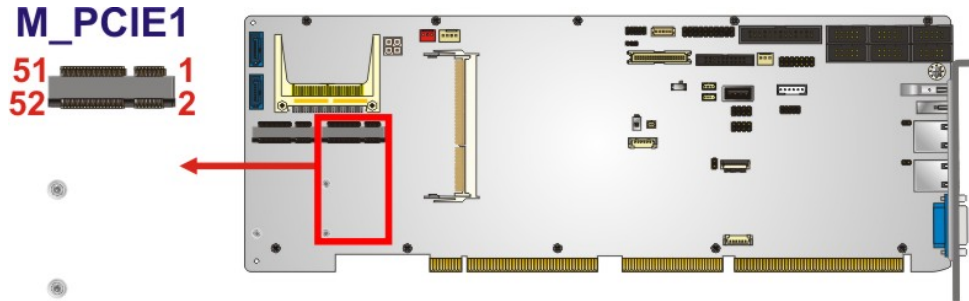

Figure 3-21: PCIe Mini Slot Location

Pin	Description	Pin	Description
1	PCIE_WAKE#	2	+3.3V
3	N/C	4	GND
5	N/C	6	1.5V
7	N/C	8	N/C
9	GND	10	N/C
11	PCIe_CLK-	12	N/C
13	PCIe_CLK+	14	N/C

WSB-BT CPU Card

Pin	Description	Pin	Description
15	GND	16	N/C
17	N/C	18	GND
19	N/C	20	+3.3V
21	GND	22	PLTRST_N
23	PCIe_RX+	24	+3.3V
25	PCIe_RX-	26	GND
27	GND	28	+1.5V
29	GND	30	SMB_CLK
31	PCIe_TX+	32	SMB_DATA
33	PCIe_TX-	34	GND
35	GND	36	USB_DATA-
37	GND	38	USB_DATA+
39	+3.3V	40	GND
41	+3.3V	42	N/C
43	+3.3V	44	N/C
45	N/C	46	N/C
47	N/C	48	+1.5V
49	N/C	50	GND
51	N/C	52	+3.3V

Table 3-23: PCIe Mini Slot Pinouts

3.2.21 SATA 3Gb/s Drive Connectors

**NOTE:**

1. The user can use either the mSATA slot or the **SATA1** connector. If an mSATA device is installed to the mSATA slot, the **SATA1** connector will be disabled.
2. The user can use either the **SATA2** connector or the CF slot. The selection is made through the BIOS option described in **Section 5.4.2**.

- CN Label:** SATA1, SATA2
- CN Type:** 7-pin SATA drive connector
- CN Location:** See **Figure 3-22**
- CN Pinouts:** See **Table 3-24**

The SATA drive connectors can be connected to SATA drives and supports up to 3Gb/s data transfer rate.

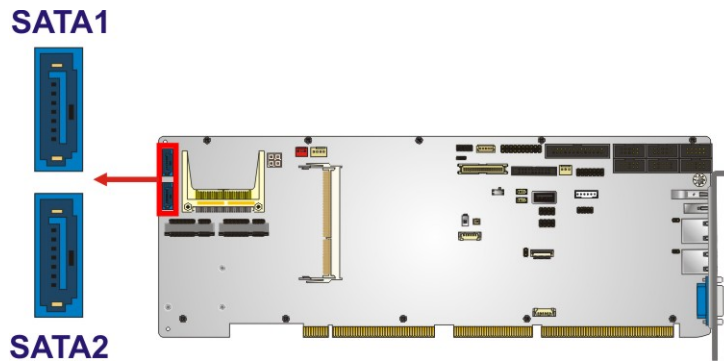

Figure 3-22: SATA 3Gb/s Drive Connector Locations

Pin	Description	Pin	Description
1	GND	2	TX +
3	TX -	4	GND
5	RX -	6	RX +
7	GND		

Table 3-24: SATA 3Gb/s Drive Connector Pinouts

WSB-BT CPU Card

3.2.22 Serial Port Connectors, RS-232/422/485

- CN Label:** COM1, COM2
- CN Type:** 10-pin box header, p=2.54 mm
- CN Location:** See **Figure 3-23**
- CN Pinouts:** See **Table 3-25**

This connector provides RS-232, RS-422 or RS-485 communications.



NOTE:

The communication protocol of the serial ports is set through the BIOS menu in “Advanced → Super IO Configuration → Serial Port 1/2 Configuration”. Use the **Transfer Mode** BIOS option to configure the correspondent serial ports (refer to **Sections 5.3.2.1.1** and **5.3.2.1.2** for detailed information).

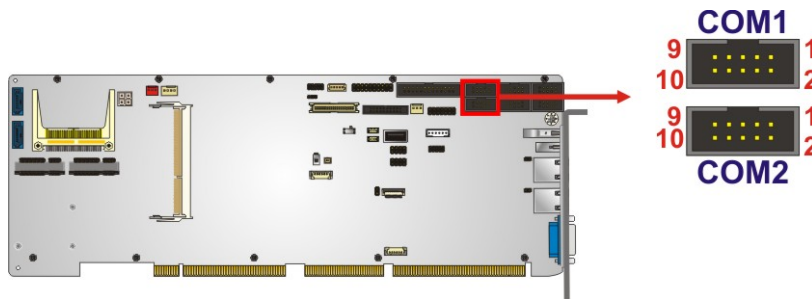

Figure 3-23: RS-232/422/485 Connector Locations

Pin	Description	Pin	Description
1	DCD	2	DSR
3	RXD	4	RTS
5	TXD	6	CTS
7	DTR	8	RI
9	GND	10	GND

Table 3-25: RS-232/422/485 Connector Pinouts

Use the optional RS-232/422/485 cable to connect to a serial device. The pinouts of the DB-9 connector are listed below.

RS-232 Pinouts	RS-422 Pinouts	RS-485 Pinouts
		

Table 3-26: DB-9 RS-422/485 Pinouts

3.2.23 Serial Port Connectors, RS-232

- CN Label:** COM3, COM4, COM5, COM6
- CN Type:** 10-pin box header, p=2.54 mm
- CN Location:** See **Figure 3-24**
- CN Pinouts:** See **Table 3-27**

Each of these connectors provides RS-232 connections.

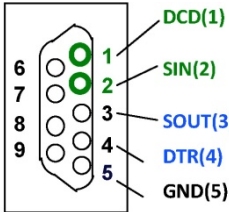
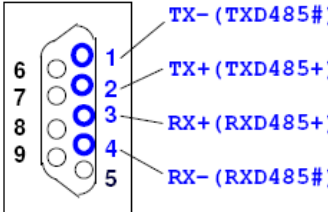
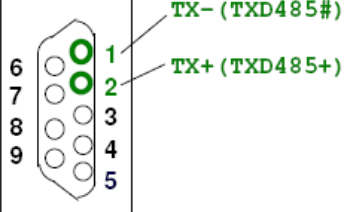
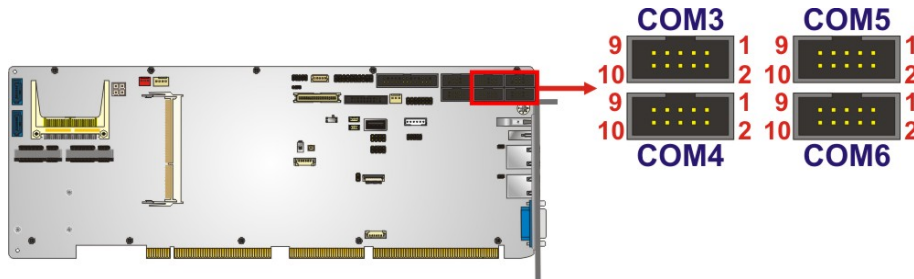

Figure 3-24: RS-232 Serial Port Connector Locations

Pin	Description	Pin	Description
1	DCD	2	DSR
3	RXD	4	RTS
5	TXD	6	CTS
7	DTR	8	RI
9	GND	10	GND

Table 3-27: RS-232 Serial Port Connector Pinouts

WSB-BT CPU Card

3.2.24 SMBus Connector

- CN Label:** SMBUS1
- CN Type:** 4-pin wafer, p=1.25 mm
- CN Location:** See **Figure 3-25**
- CN Pinouts:** See **Table 3-28**

The SMBus (System Management Bus) connector provides low-speed system management communications.

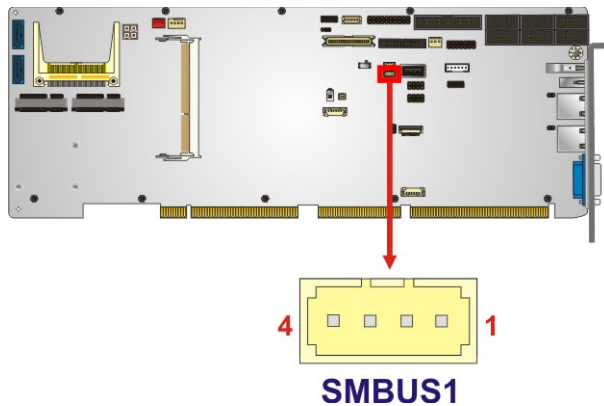

Figure 3-25: SMBus Connector Location

Pin	Description
1	GND
2	SMB_DATA
3	SMB_CLK
4	+5V

Table 3-28: SMBus Connector Pinouts

3.2.25 SO-DIMM Slot

- CN Label:** DIMM1
- CN Type:** DDR3L SO-DIMM slot
- CN Location:** See **Figure 3-26**

The SO-DIMM slot is for installing a DDR3L SO-DIMM.

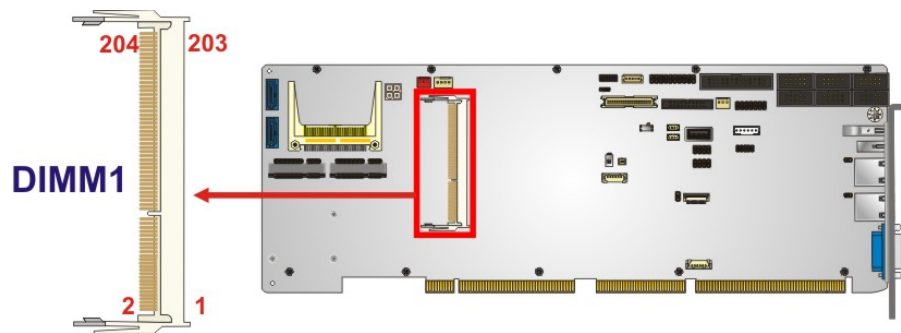

Figure 3-26: SO-DIMM Slot Location

3.2.26 SPI Flash Connector

- CN Label:** JSPI1
- CN Type:** 6-pin wafer, p=1.25 mm
- CN Location:** See **Figure 3-27**
- CN Pinouts:** See **Table 3-29**

The SPI flash connector is used to flash the SPI ROM.

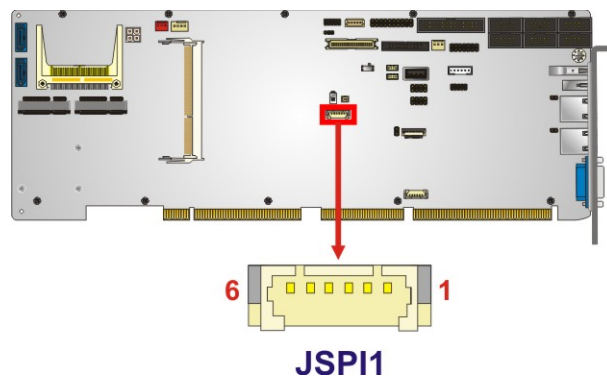

Figure 3-27: SPI Flash Connector Location

WSB-BT CPU Card

Pin	Description	Pin	Description
1	+1.8V	2	SPI_CS#
3	SPI_SO	4	SPI_CLK
5	SPI_SI	6	GND

Table 3-29: SPI Flash Connector Pinouts

3.2.27 SPI Flash Connector, EC

- CN Label:** JSPI2
- CN Type:** 6-pin wafer, p=1.25 mm
- CN Location:** See Figure 3-28
- CN Pinouts:** See Table 3-30

The SPI flash connector is used to flash the EC ROM.

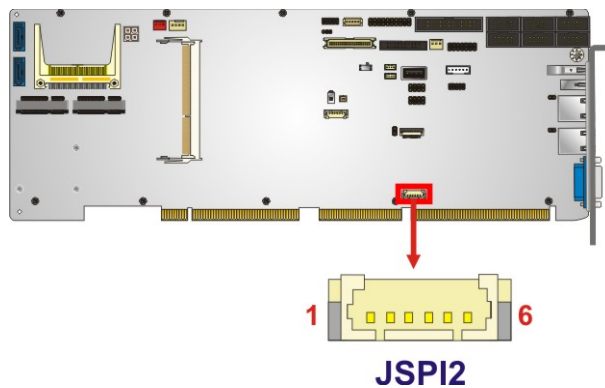

Figure 3-28: SPI EC Flash Connector Location

Pin	Description	Pin	Description
1	+3.3V	2	SPI_CS#
3	SPI_SO	4	SPI_CLK
5	SPI_SI	6	GND

Table 3-30: SPI EC Flash Connector Pinouts

3.2.28 TPM Connector

- CN Label:** TPM1
- CN Type:** 20-pin header, p=2.54 mm
- CN Location:** See **Figure 3-29**
- CN Pinouts:** See **Table 3-31**

The TPM connector connects to a TPM module.

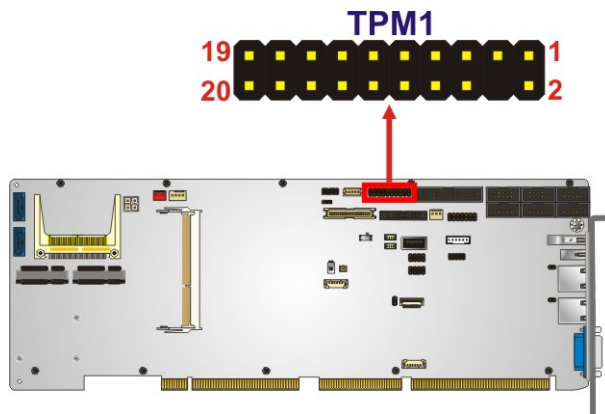

Figure 3-29: TPM Connector Location

Pin	Description	Pin	Description
1	LCLK	2	GND
3	LFRAME#	4	KEY
5	LRERST#	6	+5V
7	LAD3	8	LAD2
9	+3.3V	10	LAD1
11	LAD0	12	GND
13	SCL	14	SDA
15	SB3V	16	SERIRQ
17	GND	18	GLKRUN#
19	LPCPD#	20	LDRQ#

Table 3-31: TPM Connector Pinouts

WSB-BT CPU Card

3.2.29 USB 2.0 Connector (Type A)

- CN Label:** USB2
- CN Type:** USB Type A
- CN Location:** See **Figure 3-30**
- CN Pinouts:** See **Table 3-32**

The USB Type A connector connects to a USB 2.0/1.1 device.

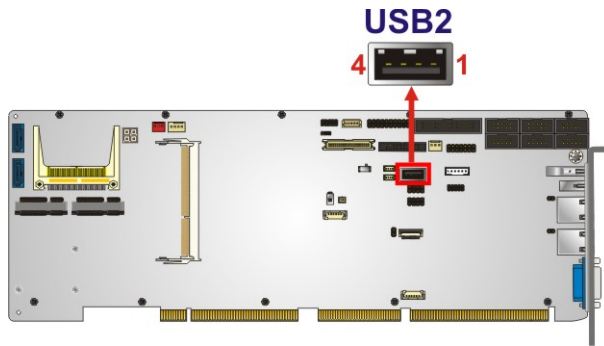

Figure 3-30: USB 2.0 Connector (Type A) Location

Pin	Description
1	VCC
2	DATA-
3	DATA+
4	GROUND

Table 3-32: USB 2.0 Connector (Type A) Pinouts

3.2.30 USB 2.0 Connectors

- CN Label:** USB2-1, USB2-2
- CN Type:** 8-pin header, p=2.54 mm
- CN Location:** See **Figure 3-31**
- CN Pinouts:** See **Table 3-33**

The USB 2.0 connectors connect to USB 2.0 devices. Each pin header provides two USB 2.0 ports.

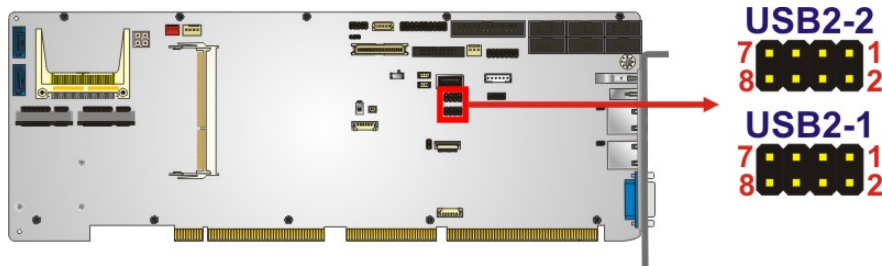

Figure 3-31: USB 2.0 Connector Locations

Pin	Description	Pin	Description
1	VCC	2	GND
3	USB_DATA-	4	USB_DATA+
5	USB_DATA+	6	USB_DATA-
7	GND	8	VCC

Table 3-33: USB 2.0 Connector Pinouts

WSB-BT CPU Card

3.3 External Peripheral Interface Connector Panel

The figure below shows the external peripheral interface connector (EPIC) panel. The EPIC panel consists of the following:

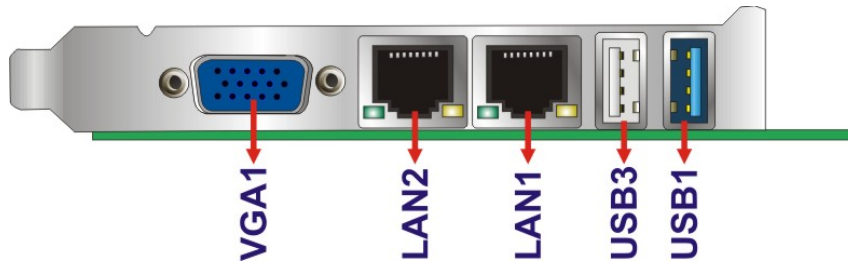

Figure 3-32: External Peripheral Interface Connector

3.3.1 Ethernet Connectors

- CN Label:** LAN1, LAN2
- CN Type:** RJ-45
- CN Location:** See Figure 3-32
- CN Pinouts:** See Table 3-34

Each LAN connector connects to a local network

Pin	Description	Pin	Description
1	MDI0+	5	MDI2+
2	MDI0-	6	MDI2-
3	MDI1+	7	MDI3+
4	MDI1-	8	MDI3-

Table 3-34: LAN Pinouts

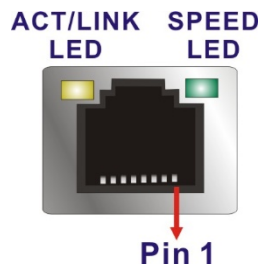

Figure 3-33: Ethernet Connector

3.3.2 USB 2.0 Connector

- CN Label:** USB3
- CN Type:** USB 2.0
- CN Location:** See **Figure 3-32**
- CN Pinouts:** See **Table 3-35**

There is one external USB 2.0 connector on the WSB-BT.

Pin	Description	Pin	Description
1	VCC	3	USB_DATA+
2	USB_DATA-	4	GND

Table 3-35: USB 2.0 Port Pinouts

3.3.3 USB 3.1 Gen 1 Connector

- CN Label:** USB1
- CN Type:** USB 3.1 Gen 1
- CN Location:** See **Figure 3-32**
- CN Pinouts:** See **Table 3-36**

There is one external USB 3.1 Gen 1 (5 Gb/s) connector on the WSB-BT.

Pin	Description	Pin	Description
1	+5V	6	USB3.0RX+
2	USB_DATA-	7	AGND

WSB-BT CPU Card

Pin	Description	Pin	Description
3	USB_DATA+	8	USB3.0 TX+
4	GND	9	USB3.0 TX-
5	USB3.0RX-		

Table 3-36: USB 3.1 Gen 1 Port Pinouts

3.3.4 VGA Connector

- CN Label:** VGA1
- CN Type:** 15-pin VGA
- CN Location:** See **Figure 3-32**
- CN Pinouts:** See **Table 3-37**

The 15-pin VGA connector connects to a monitor that accepts a standard VGA input.

Pin	Description	Pin	Description
1	RED	2	GREEN
3	BLUE	4	NC
5	GND	6	GND
7	GND	8	GND
9	VCC	10	GND
11	NC	12	DDCDA
13	HSYNC	14	VSYNC
15	DDCCLK		

Table 3-37: VGA Connector Pinouts

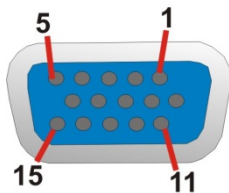

Figure 3-34: VGA Connector

Chapter

4

Installation

WSB-BT CPU Card

4.1 Anti-static Precautions



WARNING:

Failure to take ESD precautions during the installation of the WSB-BT may result in permanent damage to the WSB-BT and severe injury to the user.

Electrostatic discharge (ESD) can cause serious damage to electronic components, including the WSB-BT. Dry climates are especially susceptible to ESD. It is therefore critical that whenever the WSB-BT or any other electrical component is handled, the following anti-static precautions are strictly adhered to.

- **Wear an anti-static wristband:** - Wearing a simple anti-static wristband can help to prevent ESD from damaging the board.
- **Self-grounding:**- Before handling the board touch any grounded conducting material. During the time the board is handled, frequently touch any conducting materials that are connected to the ground.
- **Use an anti-static pad:** When configuring the WSB-BT, place it on an anti-static pad. This reduces the possibility of ESD damaging the WSB-BT.
- **Only handle the edges of the PCB:-:** When handling the PCB, hold the PCB by the edges.

4.2 Installation Considerations



NOTE:

The following installation notices and installation considerations should be read and understood before installation. All installation notices must be strictly adhered to. Failing to adhere to these precautions may lead to severe damage and injury to the person performing the installation.

**WARNING:**

The installation instructions described in this manual should be carefully followed in order to prevent damage to the components and injury to the user.

Before and during the installation please **DO** the following:

- Read the user manual:
 - The user manual provides a complete description of the WSB-BT installation instructions and configuration options.
- Wear an electrostatic discharge cuff (ESD):
 - Electronic components are easily damaged by ESD. Wearing an ESD cuff removes ESD from the body and helps prevent ESD damage.
- Place the WSB-BT on an anti-static pad:
 - When installing or configuring the motherboard, place it on an anti-static pad. This helps to prevent potential ESD damage.
- Turn all power to the WSB-BT off:
 - When working with the WSB-BT, make sure that it is disconnected from all power supplies and that no electricity is being fed into the system.

Before and during the installation of the WSB-BT, **DO NOT:**

- Remove any of the stickers on the PCB board. These stickers are required for warranty validation.
- Use the product before verifying all the cables and power connectors are properly connected.
- Allow screws to come in contact with the PCB circuit, connector pins, or its components.

WSB-BT CPU Card

4.3 SO-DIMM Installation

To install a SO-DIMM, please follow the steps below and refer to **Figure 4-1**.

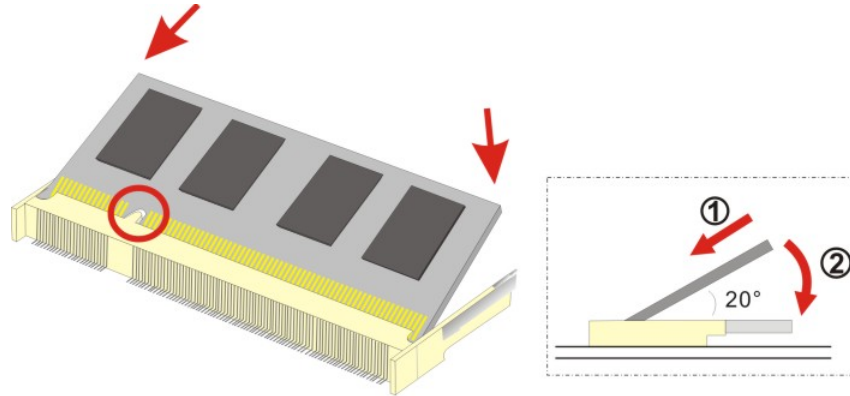

Figure 4-1: SO-DIMM Installation

- Step 1:** Locate the **SO-DIMM socket** on the solder side of the WSB-BT. Place the board on an anti-static mat.
- Step 2:** Align the **SO-DIMM with the socket**. Align the notch on the memory with the notch on the memory socket.
- Step 3:** Insert the **SO-DIMM**. Push the memory in at a 20° angle. (See **Figure 4-1**)
- Step 4:** Seat the **SO-DIMM**. Gently push downwards and the arms clip into place. (See **Figure 4-1**)

4.4 Half-size PCIe Mini Card Installation

The PCIe Mini card slot allows installation of either a full-size or half-size PCIe Mini card. To install a half-size PCIe Mini card, please follow the steps below.

Step 1: Locate the PCIe Mini card slot. See **Figure 3-21**.

Step 2: Remove the retention screw. Remove the retention screw as shown in **Figure 4-2**.

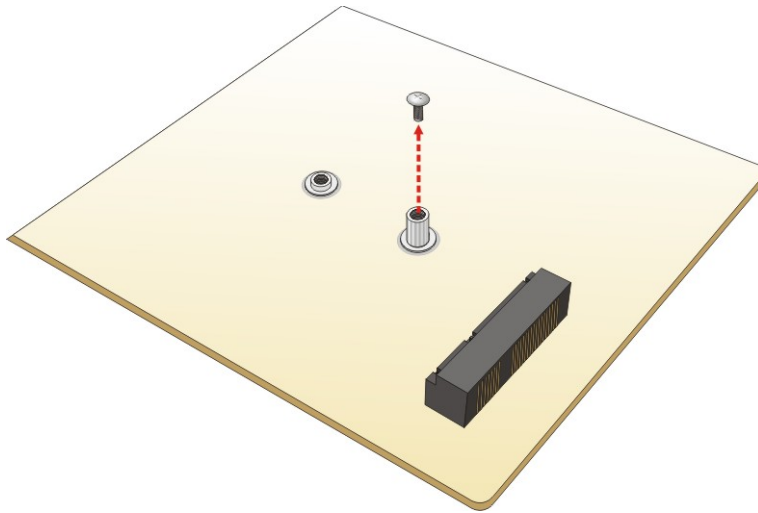

Figure 4-2: Removing the Retention Screw

Step 3: Insert into the socket at an angle. Line up the notch on the card with the notch on the slot. Slide the PCIe Mini card into the slot at an angle of about 20° (**Figure 4-3**).

WSB-BT CPU Card

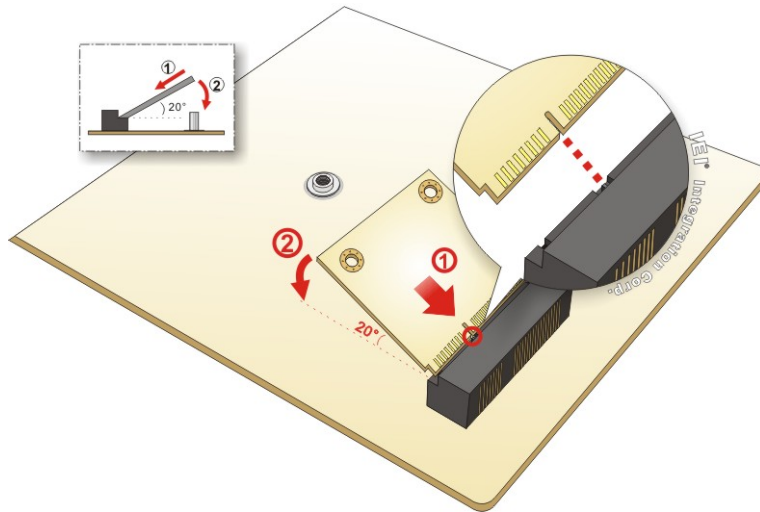

Figure 4-3: Inserting the Half-size PCIe Mini Card into the Slot at an Angle

Step 4: Secure the half-size PCIe Mini card. Secure the half-size PCIe Mini card with the retention screw previously removed (Figure 4-4).

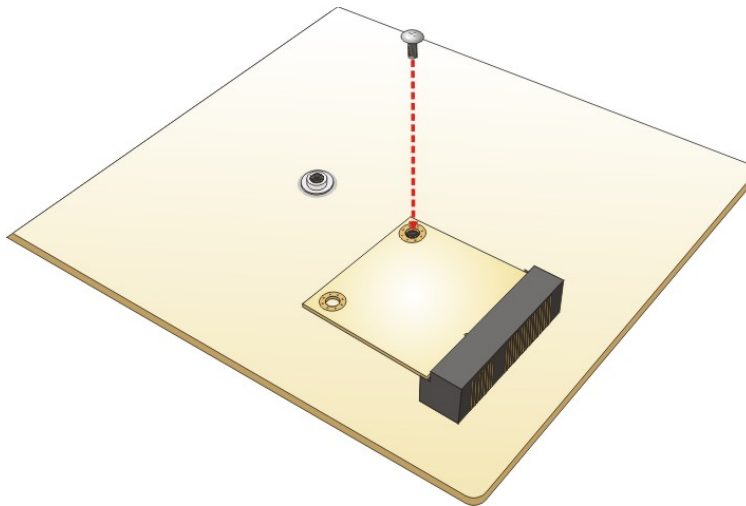

Figure 4-4: Securing the Half-size PCIe Mini Card

4.5 Full-size PCIe Mini Card Installation

The PCIe Mini card slot allows installation of either a full-size or half-size PCIe Mini card. To install a full-size PCIe Mini card, please follow the steps below.

Step 1: Locate the PCIe Mini card slot. See Figure 3-21.

Step 2: Remove the retention screw and the standoff. Remove the retention screw.

Unscrew and remove the standoff secured on the motherboard as shown in

Figure 4-5.

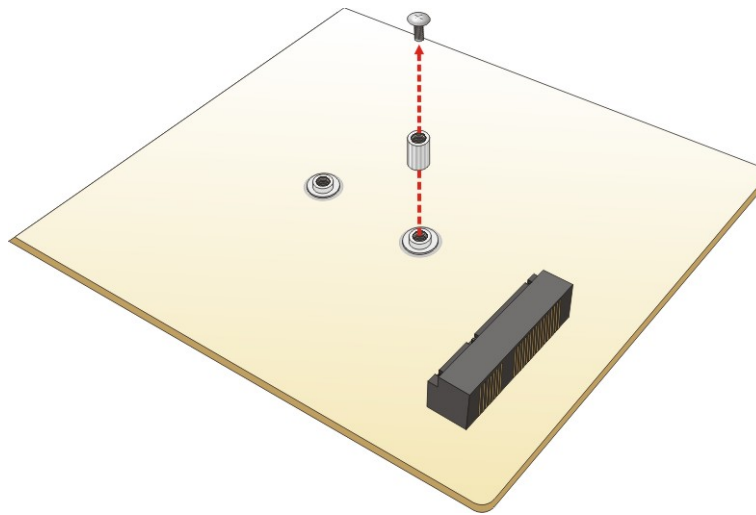

Figure 4-5: Removing the Retention Screw and the Standoff

Step 3: Install the standoff to the screw hole for the full-size PCIe Mini card. Install the previously removed standoff to the screw hole for the full-size PCIe Mini card (Figure 4-6).

WSB-BT CPU Card

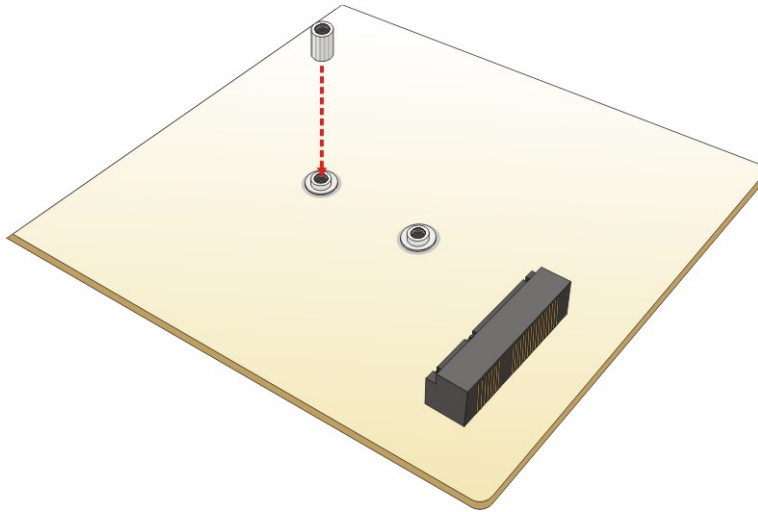

Figure 4-6: Installing the Standoff

Step 4: Insert into the socket at an angle. Line up the notch on the card with the notch on the slot. Slide the PCIe Mini card into the socket at an angle of about 20° (Figure 4-7).

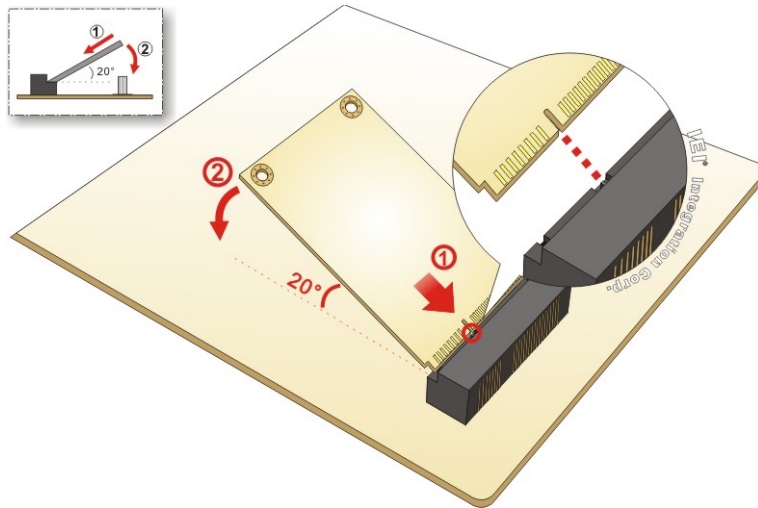

Figure 4-7: Inserting the Full-size PCIe Mini Card into the Slot at an Angle

Step 5: Secure the full-size PCIe Mini card. Secure the full-size PCIe Mini card with the retention screw previously removed (Figure 4-8).

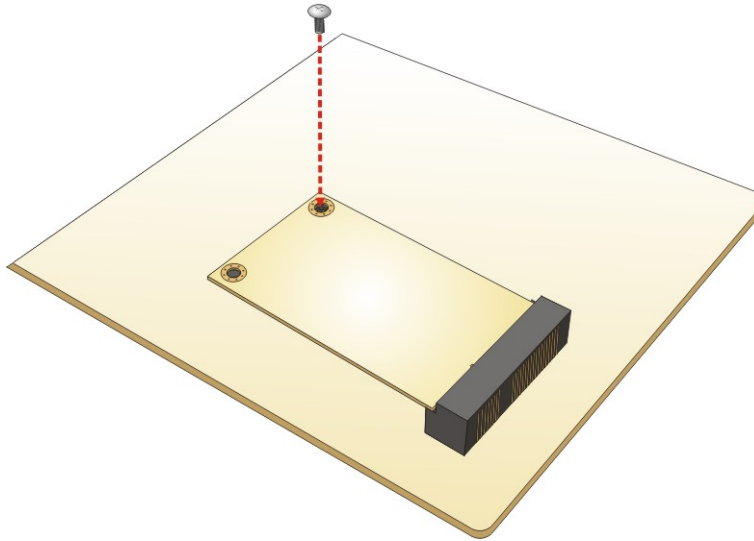

Figure 4-8: Securing the Full-size PCIe Mini Card

4.6 mSATA Module Installation



NOTE:

The user can use either the mSATA slot or the **SATA1** connector. If an mSATA device is installed to the mSATA slot (**M_SATA1**), the **SATA1** connector will be disabled.

To install an mSATA module, please follow the steps below.

Step 1: Locate the mSATA slot (Figure 3-19).

Step 2: Remove the retention screw. Remove the retention screw secured on the motherboard as shown in Figure 4-9.

WSB-BT CPU Card

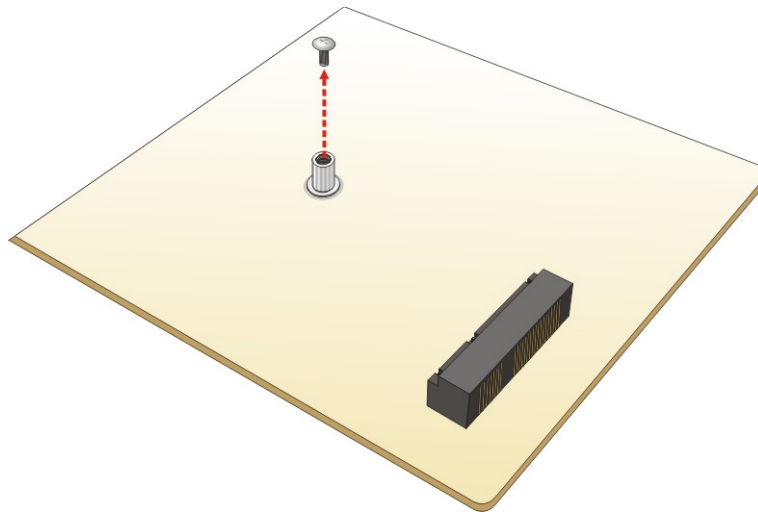

Figure 4-9: Removing the Retention Screw for the mSATA Module

Step 3: Insert into the socket at an angle. Line up the notch on the module with the notch on the connector. Slide the mSATA module into the socket at an angle of about 20° (Figure 4-10).

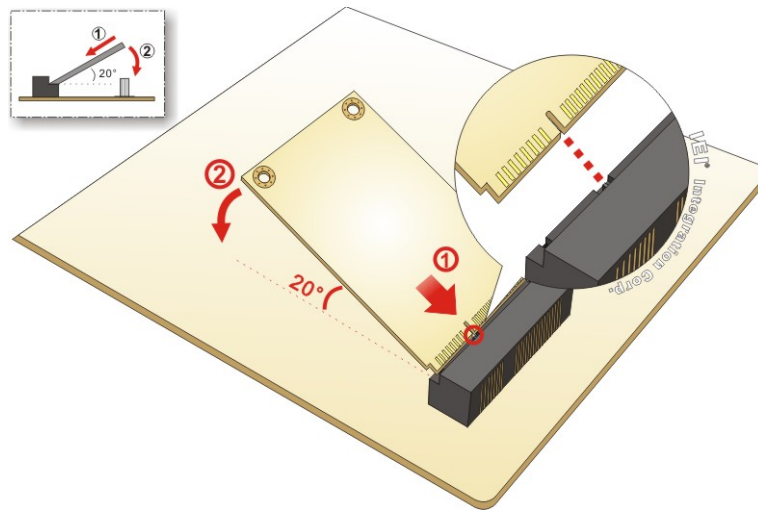

Figure 4-10: Inserting the mSATA Module into the Socket at an Angle

Step 4: Secure the mSATA module. Secure the mSATA module with the retention screws previously removed (Figure 4-11).

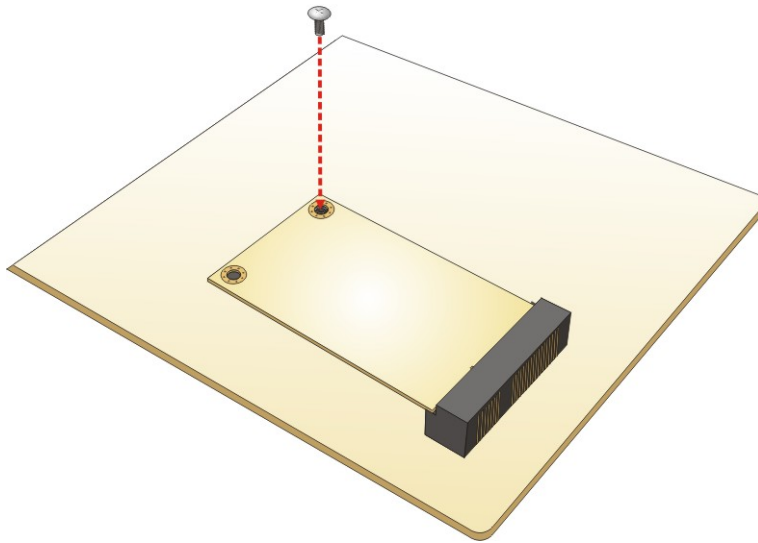

Figure 4-11: Securing the mSATA Module

4.7 CompactFlash® Installation



NOTE:

1. Both CompactFlash® Type I and Type II cards are supported.
2. The CompactFlash® card slot is disabled by default. Before the installation, please enable the CF slot by configuring the BIOS option (SATA CF Switch Setting). See **Section 5.4.2**.

To install the CompactFlash® card, please follow the steps below.

- Step 1: Locate the CF card socket.** Locate the CompactFlash® slot.
- Step 2: Align the CF card.** Align the CompactFlash® card. The label side should be facing away from the board. The grooves on the CompactFlash® slot ensure that the card cannot be inserted the wrong way.
- Step 3: Insert the CF card.** Push until the CompactFlash® card is firmly seated in the slot. See **Figure 4-12**.

WSB-BT CPU Card

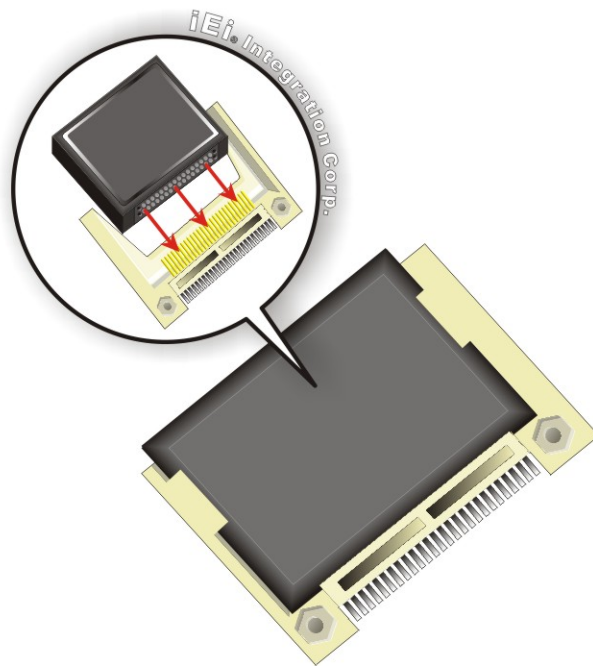

Figure 4-12: CompactFlash® Card Installation

4.8 System Configuration

The system configuration should be performed before installation.

4.8.1 AT/ATX Power Mode Setting

The AT and ATX power mode selection is made through the AT/ATX power mode switch which is shown in **Figure 4-13**.

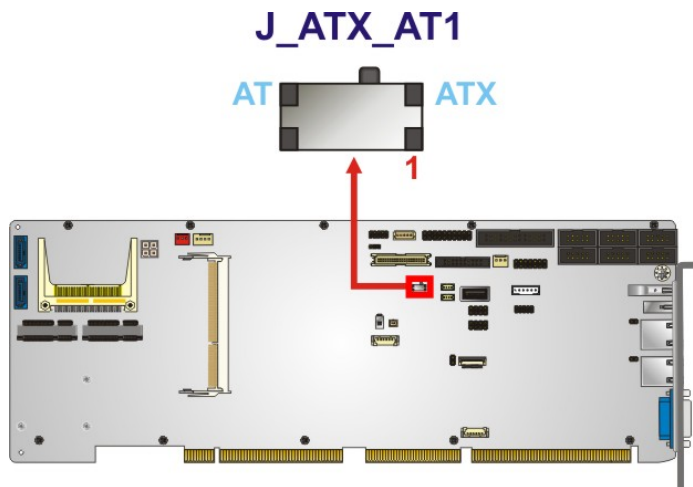

Figure 4-13: AT/ATX Power Mode Switch Location

Setting	Description
1-2	ATX power mode (default)
2-3	AT power mode

Table 4-1: AT/ATX Power Mode Switch Settings

4.8.2 Clear CMOS Button

To reset the BIOS, remove the on-board battery and press the clear CMOS button for three seconds or more. The clear CMOS button location is shown in **Figure 4-14**.

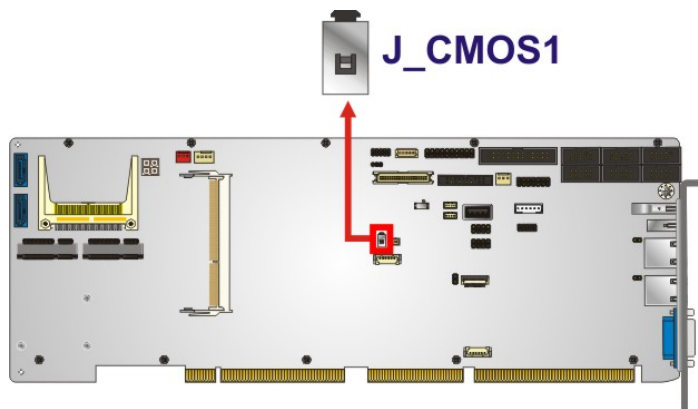

Figure 4-14: Clear CMOS Button Location

WSB-BT CPU Card

4.8.3 LVDS Voltage Selection



WARNING:

Permanent damage to the screen and WSB-BT may occur if the wrong voltage is selected with this jumper. Please refer to the user guide that came with the monitor to select the correct voltage.

Jumper Label:	JP1
Jumper Type:	3-pin header
Jumper Settings:	See Table 4-2
Jumper Location:	See Figure 4-15

The LVDS voltage selection jumper allows setting the voltage provided to the monitor connected to the LVDS connector.

Setting	Description
Short 1-2	3.3V (Default)
Short 2-3	5V

Table 4-2: LVDS Voltage Selection Jumper Settings

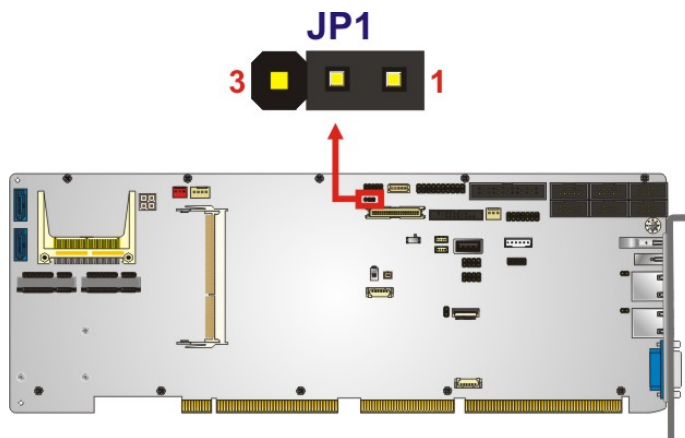

Figure 4-15: LVDS Voltage Selection Jumper Location

4.9 Internal Peripheral Device Connections

This section outlines the installation of peripheral devices to the onboard connectors.

4.9.1 SATA Drive Connection

The WSB-BT is shipped with two SATA drive cables. To connect the SATA drives to the connectors, please follow the steps below.

Step 1: Locate the connectors. The locations of the SATA drive connectors are shown in **Chapter 3**.

Step 2: Insert the cable connector. Insert the cable connector into the on-board SATA drive connector until it clips into place. See **Figure 4-16**.

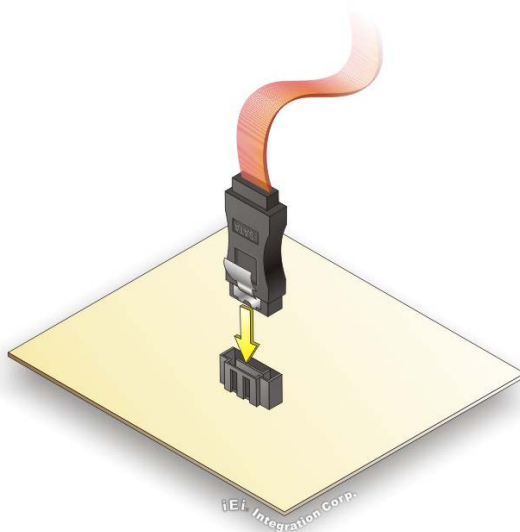

Figure 4-16: SATA Drive Cable Connection

Step 3: Connect the cable to the SATA disk. Connect the connector on the other end of the cable to the connector at the back of the SATA drive. See **Figure 4-17**.

Step 4: Connect the SATA power cable. Connect the SATA power connector to the back of the SATA drive. See **Figure 4-17**.

WSB-BT CPU Card

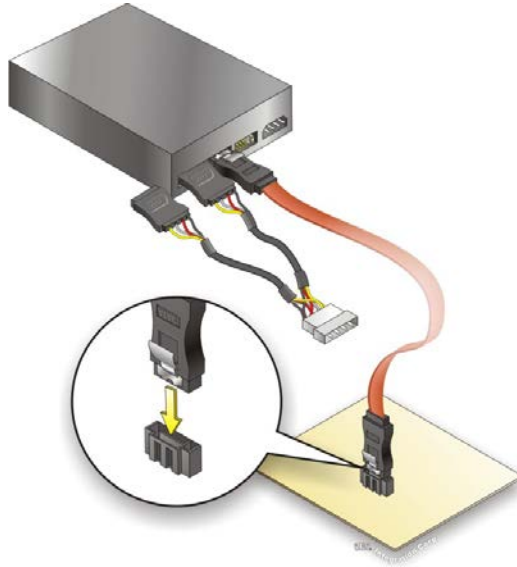

Figure 4-17: SATA Power Drive Connection

The SATA power cable can be bought from IEI. See Optional Items in Section 2.4.

4.10 OS Installation



WARNING:

Before installing the operating system, the user must enter the **Boot** BIOS menu first and choose which operating system will be installed. Otherwise, the OS installation may fail. Please refer to **Figure 4-18** and **Section 5.6**.

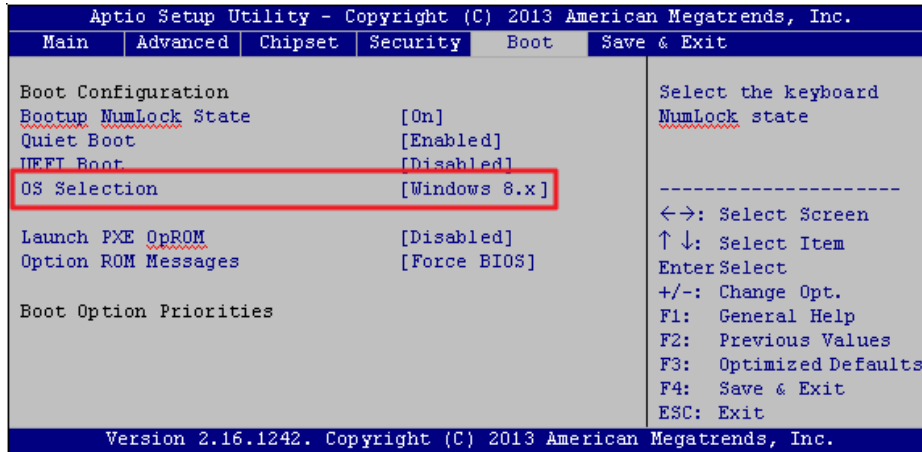

Figure 4-18: BIOS Option – OS Selection

Chapter

5

BIOS

5.1 Introduction

The BIOS is programmed onto the BIOS chip. The BIOS setup program allows changes to certain system settings. This chapter outlines the options that can be changed.



NOTE:

Some of the BIOS options may vary throughout the life cycle of the product and are subject to change without prior notice.

5.1.1 Starting Setup

The UEFI BIOS is activated when the computer is turned on. The setup program can be activated in one of two ways.

1. Press the **DEL** or **F2** key as soon as the system is turned on or
2. Press the **DEL** or **F2** key when the “**Press DEL or F2 to enter SETUP**” message appears on the screen.

If the message disappears before the **DEL** or **F2** key is pressed, restart the computer and try again.

5.1.2 Using Setup

Use the arrow keys to highlight items, press **ENTER** to select, use the PageUp and PageDown keys to change entries, press **F1** for help and press **ESC** to quit. Navigation keys are shown in the following table.

Key	Function
Up arrow	Move to previous item
Down arrow	Move to next item
Left arrow	Move to the item on the left hand side
Right arrow	Move to the item on the right hand side
+	Increase the numeric value or make changes
-	Decrease the numeric value or make changes

WSB-BT CPU Card

Key	Function
Page Up	Move to the previous page
Page Dn	Move to the next page
Esc	Main Menu – Quit and not save changes into CMOS Status Page Setup Menu and Option Page Setup Menu -- Exit current page and return to Main Menu
F1	General help, only for Status Page Setup Menu and Option Page Setup Menu
F2	Load previous values
F3	Load optimized defaults
F4	Save changes and Exit BIOS

Table 5-1: BIOS Navigation Keys

5.1.3 Getting Help

When **F1** is pressed, a small help window describing the appropriate keys to use and the possible selections for the highlighted item appears. To exit the Help Window, press **Esc**.

5.1.4 Unable to Reboot after Configuration Changes

If the computer cannot boot after changes to the system configuration is made, CMOS defaults. Use the clear CMOS button described in **Chapter 4**.

5.1.5 BIOS Menu Bar

The **menu bar** on top of the BIOS screen has the following main items:

- Main – Changes the basic system configuration.
- Advanced – Changes the advanced system settings.
- Chipset – Changes the chipset settings.
- Security – Sets User and Supervisor Passwords.
- Boot – Changes the system boot configuration.
- Save & Exit – Selects exit options and loads default settings

The following sections completely describe the configuration options found in the menu items at the top of the BIOS screen and listed above.

5.2 Main

The **Main** BIOS menu (**BIOS Menu 1**) appears when the **BIOS Setup** program is entered.

The **Main** menu gives an overview of the basic system information.

Aptio Setup Utility - Copyright (C) 2013 American Megatrends, Inc.		
Main	Advanced	Chipset Security Boot Save & Exit
BIOS Information		Set the Date. Use Tab to switch between Date elements.
BIOS Vendor	American Megatrends	
Core Version	5.009	
Compliance	UEFI 2.3; PI 1.2	
Project Version	B3471AI10.ROM	
Build Date and Time	03/23/2018 14:48:20	

iWDD Vendor	iEi	→←: Select Screen
iWDD Version	B471ET18.bin	↑ ↓: Select Item

CPU Configuration		Enter: Select
Microcode Patch	90a	+/-: Change Opt.
BayTrail SoC	D0 Stepping	F1: General Help

Memory Information		F2: Previous Values
Total Memory	4096 MB (LPDDR3)	F3: Optimized Defaults

TXE Information		F4: Save & Exit
Sec RC Version	00.05.00.00	ESC: Exit
TXE FW Version	01.00.02.1060	

System Date	[Fri 01/01/2010]	
System Time	[00:10:27]	

Access Level	Administrator	

Version 2.16.1242. Copyright (C) 2013 American Megatrends, Inc.		

BIOS Menu 1: Main

The **Main** menu has two user configurable fields:

➔ **System Date [xx/xx/xx]**

Use the **System Date** option to set the system date. Manually enter the day, month and year.

➔ **System Time [xx:xx:xx]**

Use the **System Time** option to set the system time. Manually enter the hours, minutes and seconds.

WSB-BT CPU Card

5.3 Advanced

Use the **Advanced** menu (**BIOS Menu 2**) to configure the CPU and peripheral devices through the following sub-menus:



WARNING!

Setting the wrong values in the sections below may cause the system to malfunction. Make sure that the settings made are compatible with the hardware.

```

Aptio Setup Utility - Copyright (C) 2013 American Megatrends, Inc.
Main  Advanced  Chipset  Security  Boot  Save & Exit
-----
> Trusted Computing
> F81866 Super IO Configuration
> iWDD H/M Monitor
> Serial Port Console Redirection
> iEi Feature
> CPU Configuration
> IDE Configuration
> USB Configuration

System ACPI Parameters
-----
-><: Select Screen
↑↓: Select Item
Enter: Select
+/-: Change Opt.
F1: General Help
F2: Previous Values
F3: Optimized Defaults
F4: Save & Exit
ESC: Exit

Version 2.16.1242. Copyright (C) 2013 American Megatrends, Inc.

```

BIOS Menu 2: Advanced

5.3.1 Trusted Computing

Use the **Trusted Computing** menu (**BIOS Menu 3**) to configure settings related to the Trusted Computing Group (TCG) Trusted Platform Module (TPM).

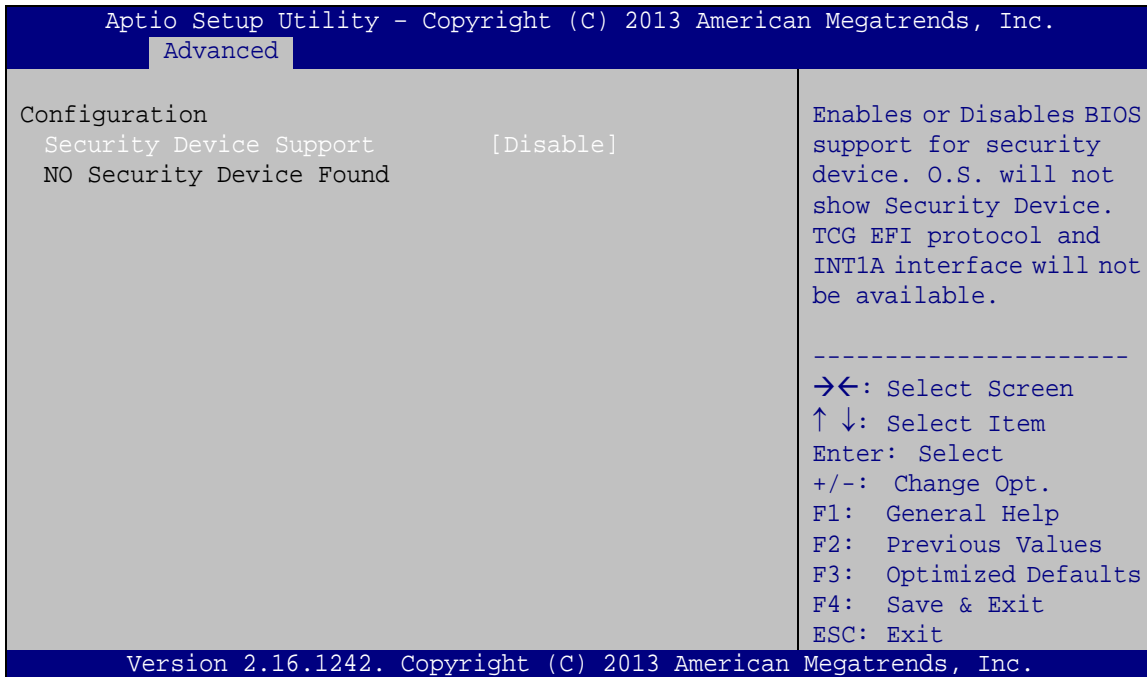

BIOS Menu 3: Trusted Computing

→ Security Device Support [Disable]

Use the **Security Device Support** option to configure support for the TPM.

- **Disable** DEFAULT TPM support is disabled.
- **Enable** TPM support is enabled.

WSB-BT CPU Card

5.3.2 F81866 Super IO Configuration

Use the **F81866 Super IO Configuration** menu (**BIOS Menu 4**) to set or change the configurations for the serial ports and parallel port.

```

Aptio Setup Utility - Copyright (C) 2013 American Megatrends, Inc.
  Advanced
F81866 Super IO Configuration                               Set Parameters of Serial
                                                           Port 1 (COMA)
F81866 Super IO Chip                                     F81866
> Serial Port 1 Configuration
> Serial Port 2 Configuration
> Serial Port 3 Configuration
> Serial Port 4 Configuration
> Serial Port 5 Configuration
> Serial Port 6 Configuration
> Parallel Port Configuration

-----
-><: Select Screen
↑ ↓: Select Item
Enter: Select
+/-: Change Opt.
F1: General Help
F2: Previous Values
F3: Optimized Defaults
F4: Save & Exit
ESC: Exit

Version 2.16.1242. Copyright (C) 2013 American Megatrends, Inc.
  
```

BIOS Menu 4: F81866 Super IO Configuration

5.3.2.1 Serial Port n Configuration

Use the **Serial Port n Configuration** menu (**BIOS Menu 5**) to configure the serial port n.

```

Aptio Setup Utility - Copyright (C) 2013 American Megatrends, Inc.
  Advanced
Serial Port n Configuration                               Enable or Disable Serial
                                                           Port (COM)
Serial Port                                             [Enabled]
Device Settings                                         IO=3F8h; IRQ=4

-----
-><: Select Screen
↑ ↓: Select Item
Enter: Select
+/-: Change Opt.
F1: General Help
F2: Previous Values
F3: Optimized Defaults
F4: Save & Exit
ESC: Exit

Version 2.16.1242. Copyright (C) 2013 American Megatrends, Inc.
  
```

BIOS Menu 5: Serial Port n Configuration Menu

5.3.2.1.1 Serial Port 1 Configuration

→ **Serial Port [Enabled]**

Use the **Serial Port** option to enable or disable the serial port.

- **Disabled** Disable the serial port
- **Enabled** **DEFAULT** Enable the serial port

→ **Change Settings [Auto]**

Use the **Change Settings** option to change the serial port IO port address and interrupt address.

- **Auto** **DEFAULT** The serial port IO port address and interrupt address are automatically detected.
- **IO=3F8h;**
IRQ=4 Serial Port I/O port address is 3F8h and the interrupt address is IRQ4
- **IO=3F8h;**
IRQ=3, 4 Serial Port I/O port address is 3F8h and the interrupt address is IRQ3, 4
- **IO=2F8h;**
IRQ=3, 4 Serial Port I/O port address is 2F8h and the interrupt address is IRQ3, 4
- **IO=3E8h;**
IRQ=3, 4 Serial Port I/O port address is 3E8h and the interrupt address is IRQ3, 4
- **IO=2E8h;**
IRQ=3, 4 Serial Port I/O port address is 2E8h and the interrupt address is IRQ3, 4

WSB-BT CPU Card

→ Transfer Mode [RS232]

Use the **Transfer Mode** option to select the Serial Port 1 signaling mode.

- **RS422** Serial Port 1 signaling mode is RS-422
- **RS232** **DEFAULT** Serial Port 1 signaling mode is RS-232
- **RS485** Serial Port 1 signaling mode is RS-485

5.3.2.1.2 Serial Port 2 Configuration

→ Serial Port [Enabled]

Use the **Serial Port** option to enable or disable the serial port.

- **Disabled** Disable the serial port
- **Enabled** **DEFAULT** Enable the serial port

→ Change Settings [Auto]

Use the **Change Settings** option to change the serial port IO port address and interrupt address.

- **Auto** **DEFAULT** The serial port IO port address and interrupt address are automatically detected.
- **IO=2F8h;
IRQ=3** Serial Port I/O port address is 2F8h and the interrupt address is IRQ3
- **IO=3F8h;
IRQ=3, 4** Serial Port I/O port address is 3F8h and the interrupt address is IRQ3, 4
- **IO=2F8h;
IRQ=3, 4** Serial Port I/O port address is 2F8h and the interrupt address is IRQ3, 4
- **IO=3E8h;
IRQ=3, 4** Serial Port I/O port address is 3E8h and the interrupt address is IRQ3, 4
- **IO=2E8h;
IRQ=3, 4** Serial Port I/O port address is 2E8h and the interrupt address is IRQ3, 4

→ **Transfer Mode [RS232]**

Use the **Transfer Mode** option to select the Serial Port 2 signaling mode.

- **RS422** Serial Port 2 signaling mode is RS-422
- **RS232** **DEFAULT** Serial Port 2 signaling mode is RS-232
- **RS485** Serial Port 2 signaling mode is RS-485

5.3.2.1.3 Serial Port 3 Configuration

→ **Serial Port [Enabled]**

Use the **Serial Port** option to enable or disable the serial port.

- **Disabled** Disable the serial port
- **Enabled** **DEFAULT** Enable the serial port

→ **Change Settings [Auto]**

Use the **Change Settings** option to change the serial port IO port address and interrupt address.

- **Auto** **DEFAULT** The serial port IO port address and interrupt address are automatically detected.
- **IO=3E8h;**
IRQ=10 Serial Port I/O port address is 3E8h and the interrupt address is IRQ10
- **IO=3F8h;**
IRQ=10 Serial Port I/O port address is 3F8h and the interrupt address is IRQ10
- **IO=2F8h;**
IRQ=10 Serial Port I/O port address is 2F8h and the interrupt address is IRQ10
- **IO=3E8h;**
IRQ=10 Serial Port I/O port address is 3E8h and the interrupt address is IRQ10
- **IO=2E8h;**
IRQ=10 Serial Port I/O port address is 2E8h and the interrupt address is IRQ10

WSB-BT CPU Card

- ➔ **IO=2E0h;**
IRQ=10 Serial Port I/O port address is 2E0h and the interrupt address is IRQ10

5.3.2.1.4 Serial Port 4 Configuration

➔ Serial Port [Enabled]

Use the **Serial Port** option to enable or disable the serial port.

- ➔ **Disabled** Disable the serial port
- ➔ **Enabled** **DEFAULT** Enable the serial port

➔ Change Settings [Auto]

Use the **Change Settings** option to change the serial port IO port address and interrupt address.

- ➔ **Auto** **DEFAULT** The serial port IO port address and interrupt address are automatically detected.
- ➔ **IO=2E8h;**
IRQ=10 Serial Port I/O port address is 2E8h and the interrupt address is IRQ10
- ➔ **IO=3F8h;**
IRQ=10 Serial Port I/O port address is 3F8h and the interrupt address is IRQ10
- ➔ **IO=2F8h;**
IRQ=10 Serial Port I/O port address is 2F8h and the interrupt address is IRQ10
- ➔ **IO=3E8h;**
IRQ=10 Serial Port I/O port address is 3E8h and the interrupt address is IRQ10
- ➔ **IO=2E8h;**
IRQ=10 Serial Port I/O port address is 2E8h and the interrupt address is IRQ10
- ➔ **IO=2E0h;**
IRQ=10 Serial Port I/O port address is 2E0h and the interrupt address is IRQ10

5.3.2.1.5 Serial Port 5 Configuration

→ **Serial Port [Enabled]**

Use the **Serial Port** option to enable or disable the serial port.

- **Disabled** Disable the serial port
- **Enabled DEFAULT** Enable the serial port

→ **Change Settings [Auto]**

Use the **Change Settings** option to change the serial port IO port address and interrupt address.

- **Auto DEFAULT** The serial port IO port address and interrupt address are automatically detected.
- **IO=2D0h;
IRQ=10** Serial Port I/O port address is 2D0h and the interrupt address is IRQ10
- **IO=3F8h;
IRQ=10** Serial Port I/O port address is 3F8h and the interrupt address is IRQ10
- **IO=2F8h;
IRQ=10** Serial Port I/O port address is 2F8h and the interrupt address is IRQ10
- **IO=3E8h;
IRQ=10** Serial Port I/O port address is 3E8h and the interrupt address is IRQ10
- **IO=2E8h;
IRQ=10** Serial Port I/O port address is 2E8h and the interrupt address is IRQ10
- **IO=2D0h;
IRQ=10** Serial Port I/O port address is 2D0h and the interrupt address is IRQ10
- **IO=2E0h;
IRQ=10** Serial Port I/O port address is 2E0h and the interrupt address is IRQ10

WSB-BT CPU Card

5.3.2.1.6 Serial Port 6 Configuration

→ Serial Port [Enabled]

Use the **Serial Port** option to enable or disable the serial port.

- **Disabled** Disable the serial port
- **Enabled DEFAULT** Enable the serial port

→ Change Settings [Auto]

Use the **Change Settings** option to change the serial port IO port address and interrupt address.

- **Auto DEFAULT** The serial port IO port address and interrupt address are automatically detected.
- **IO=2E0h;
IRQ=10** Serial Port I/O port address is 2E0h and the interrupt address is IRQ10
- **IO=3F8h;
IRQ=10** Serial Port I/O port address is 3F8h and the interrupt address is IRQ10
- **IO=2F8h;
IRQ=10** Serial Port I/O port address is 2F8h and the interrupt address is IRQ10
- **IO=3E8h;
IRQ=10** Serial Port I/O port address is 3E8h and the interrupt address is IRQ10
- **IO=2E8h;
IRQ=10** Serial Port I/O port address is 2E8h and the interrupt address is IRQ10
- **IO=2D0h;
IRQ=10** Serial Port I/O port address is 2D0h and the interrupt address is IRQ10
- **IO=2E0h;
IRQ=10** Serial Port I/O port address is 2E0h and the interrupt address is IRQ10

5.3.2.2 Parallel Port Configuration

Use the **Parallel Port Configuration** menu (**BIOS Menu 6**) to configure the serial port n.

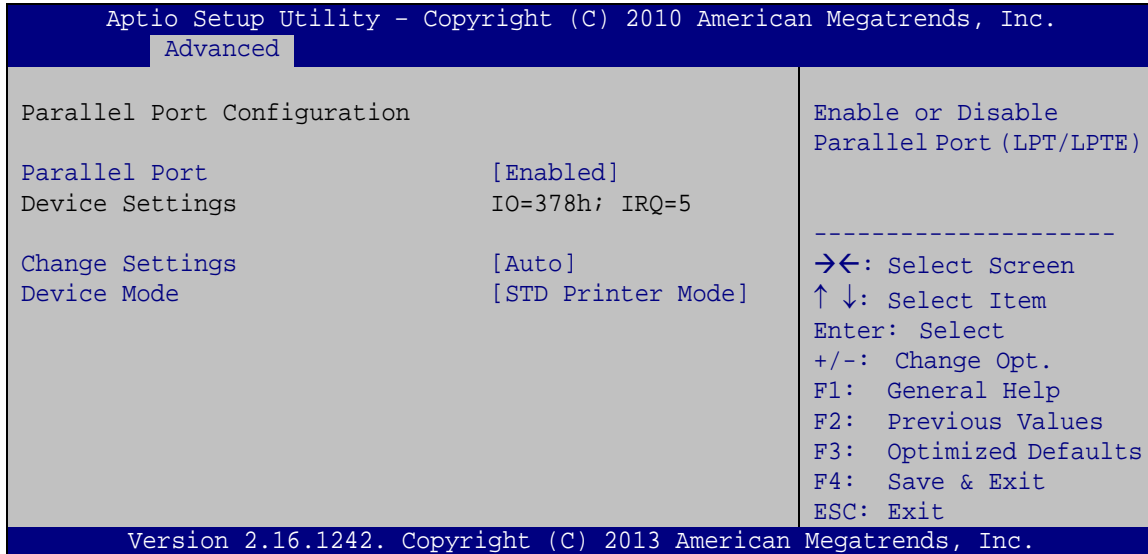

BIOS Menu 6: Parallel Port Configuration Menu

→ Parallel Port [Enabled]

Use the **Parallel Port** option to enable or disable the parallel port.

- **Disabled** Disable the parallel port
- **Enabled DEFAULT** Enable the parallel port

→ Change Settings [Auto]

Use the **Change Settings** option to change the parallel port IO port address and interrupt address.

- **Auto DEFAULT** The parallel port IO port address and interrupt address are automatically detected.
- **IO=378h; Parallel Port I/O port address is 378h and the
IRQ=5 interrupt address is IRQ5.**

WSB-BT CPU Card

- **IO=378h;** Parallel Port I/O port address is 378h and the
IRQ=5, 6, interrupt address is IRQ5, 6, 7, 9, 10, 11 12
7, 9, 10, 11,
12
- **IO=278h;** Parallel Port I/O port address is 278h and the
IRQ=5, 6, interrupt address is IRQ5, 6, 7, 9, 10, 11, 12
7, 9, 10, 11,
12
- **IO=3BCh;** Parallel Port I/O port address is 3BCh and the
IRQ=5, 6, interrupt address is IRQ5, 6, 7, 9, 10, 11, 12.
7, 9, 10, 11,
12

→ **Device Mode [STD Printer Mode]**

Use the **Device Mode** option to select the mode the parallel port operates in. Configuration options are listed below.

- STD Printer Mode **Default**
- SPP Mode
- EPP-1.9 and SPP Mode
- EPP-1.7 and SPP Mode
- ECP Mode
- ECP and EPP 1.9 Mode
- ECP and EPP 1.7 Mode

5.3.3 iWDD H/W Monitor

The **iWDD H/W Monitor** menu (**BIOS Menu 7**) contains the fan configuration submenu, and displays operating temperature, fan speeds and system voltages..

```

Aptio Setup Utility - Copyright (C) 2013 American Megatrends, Inc.
Advanced
PC Health Status
CPU temperature           : +40°C
System temperature       : +31°C

CPU_FAN1 Speed           : N/A
SYS_FAN1 Speed           : N/A

CPU_CORE                  : +0.888 V
+5V                       : +5.104 V
+12V                      : +12.480 V
DDR                       : +1.360 V
+5VSB                     : +5.016 V
+3.3V                     : +3.294 V
+3.3VSB                   : +3.253 V

> Smart Fan Mode Configuration

Smart Fan Mode Select

-----
-><: Select Screen
↑↓: Select Item
Enter: Select
+/-: Change Opt.
F1: General Help
F2: Previous Values
F3: Optimized Defaults
F4: Save & Exit
ESC: Exit

Version 2.16.1242. Copyright (C) 2013 American Megatrends, Inc.
    
```

BIOS Menu 7: iWDD H/W Monitor

➔ PC Health Status

The following system parameters and values are shown. The system parameters that are monitored are:

- System Temperatures:
 - CPU Temperature
 - System Temperature
- Fan Speeds:
 - CPU Fan Speed
 - System Fan Speed
- Voltages:
 - CPU_CORE
 - +5V
 - +12V
 - DDR

WSB-BT CPU Card

- +5VSB
- +3.3V
- +3.3VSB

5.3.3.1 Smart Fan Mode Configuration

Use the **Smart Fan Mode Configuration** submenu (**BIOS Menu 8**) to configure fan speed settings.

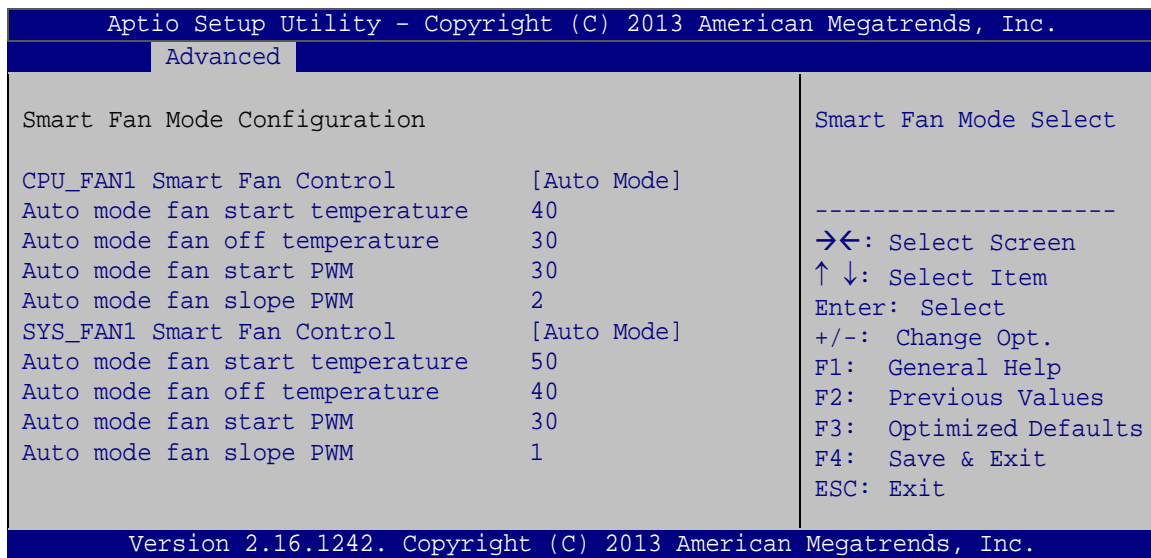

BIOS Menu 8: Smart Fan Mode Configuration

→ CPU_FAN1 Smart Fan Control/SYS_FAN1 Smart Fan Control [Auto Mode]

Use the **CPU_FAN1 Smart Fan Control/SYS_FAN1 Smart Fan Control** option to configure the CPU/System Smart Fan.

- **Manual Mode** The fan spins at the speed set in Manual Mode settings.
- **Auto Mode** **DEFAULT** The fan adjusts its speed using Auto Mode settings.

→ Auto mode fan start/off temperature

Use the + or – key to change the **Auto mode fan start/off temperature** value. Enter a decimal number between 1 and 100.

➔ **Auto mode fan start PWM**

Use the + or – key to change the **Auto mode fan start PWM** value. Enter a decimal number between 1 and 100.

➔ **Auto mode fan slope PWM**

Use the + or – key to change the **Auto mode fan slope PWM** value. Enter a decimal number between 1 and 8.

5.3.4 Serial Port Console Redirection

The **Serial Port Console Redirection** menu (**BIOS Menu 9**) allows the console redirection options to be configured. Console redirection allows users to maintain a system remotely by re-directing keyboard input and text output through the serial port.

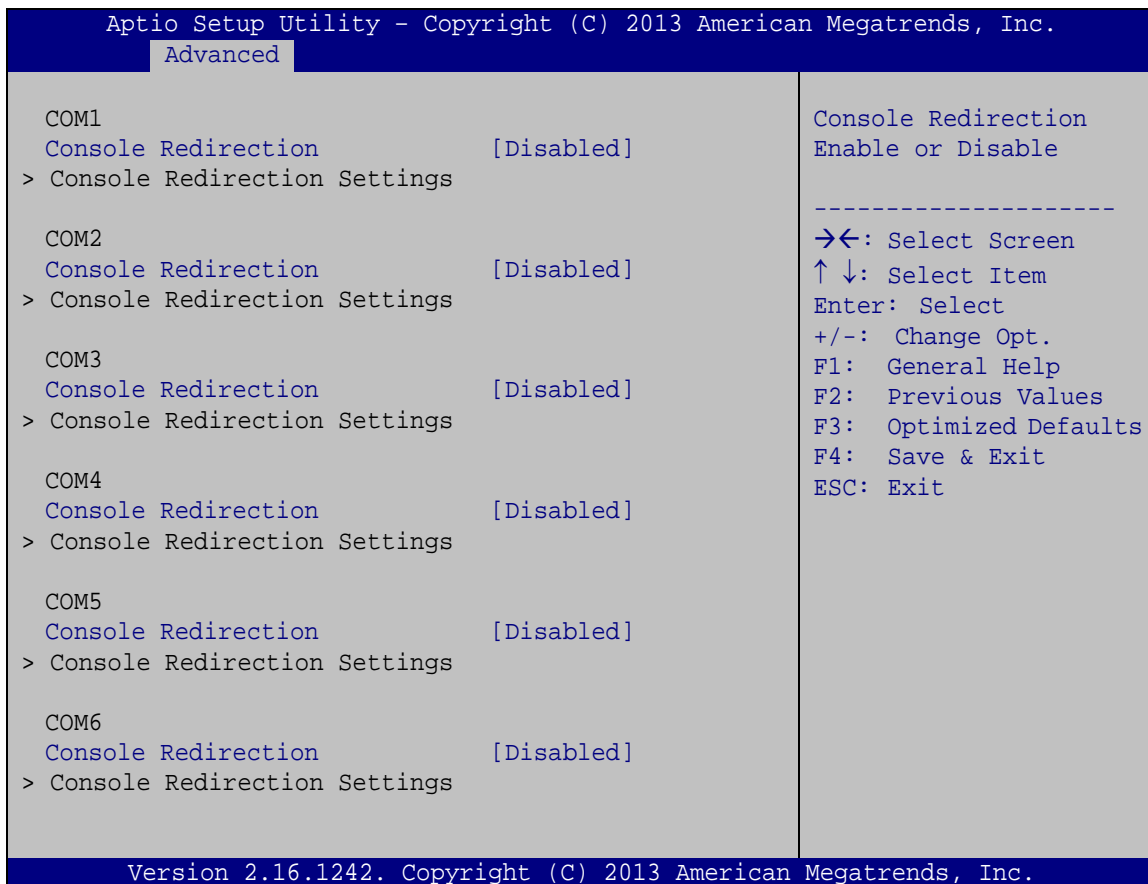

BIOS Menu 9: Serial Port Console Redirection

WSB-BT CPU Card

→ Console Redirection [Disabled]

Use **Console Redirection** option to enable or disable the console redirection function.

- **Disabled** **DEFAULT** Disabled the console redirection function
- **Enabled** Enabled the console redirection function

The following options are available in the **Console Redirection Settings** submenu when the **Console Redirection** option is enabled.

→ Terminal Type [ANSI]

Use the **Terminal Type** option to specify the remote terminal type.

- **VT100** The target terminal type is VT100
- **VT100+** The target terminal type is VT100+
- **VT-UTF8** The target terminal type is VT-UTF8
- **ANSI** **DEFAULT** The target terminal type is ANSI

→ Bits per second [115200]

Use the **Bits per second** option to specify the serial port transmission speed. The speed must match the other side. Long or noisy lines may require lower speeds.

- **9600** Sets the serial port transmission speed at 9600.
- **19200** Sets the serial port transmission speed at 19200.
- **38400** Sets the serial port transmission speed at 38400.
- **57600** Sets the serial port transmission speed at 57600.
- **115200** **DEFAULT** Sets the serial port transmission speed at 115200.

→ Data Bits [8]

Use the **Data Bits** option to specify the number of data bits.

- **7** Sets the data bits at 7.
- **8** **DEFAULT** Sets the data bits at 8.

→ Parity [None]

Use the **Parity** option to specify the parity bit that can be sent with the data bits for detecting the transmission errors.

- | | | |
|----------------|----------------|---|
| → None | DEFAULT | No parity bit is sent with the data bits. |
| → Even | | The parity bit is 0 if the number of ones in the data bits is even. |
| → Odd | | The parity bit is 0 if the number of ones in the data bits is odd. |
| → Mark | | The parity bit is always 1. This option does not provide error detection. |
| → Space | | The parity bit is always 0. This option does not provide error detection. |

→ Stop Bits [1]

Use the **Stop Bits** option to specify the number of stop bits used to indicate the end of a serial data packet. Communication with slow devices may require more than 1 stop bit.

- | | | |
|------------|----------------|------------------------------------|
| → 1 | DEFAULT | Sets the number of stop bits at 1. |
| → 2 | | Sets the number of stop bits at 2. |

WSB-BT CPU Card

5.3.5 iEi Feature

Use the **iEi Feature** menu (**BIOS Menu 10**) to configure One Key Recovery function.

```

Aptio Setup Utility - Copyright (C) 2013 American Megatrends, Inc.
  Advanced
iEi Feature
Auto Recovery Function          [Disabled]
                                Auto Recovery Function
                                Reboot and recover
                                system automatically
                                within 10 min, when OS
                                crashes. Please install
                                Auto Recovery API
                                service before enabling
                                this function.
                                -----
                                →←: Select Screen
                                ↑ ↓: Select Item
                                Enter: Select
                                +/-: Change Opt.
                                F1:  General Help
                                F2:  Previous Values
                                F3:  Optimized Defaults
                                F4:  Save & Exit
                                ESC: Exit
Version 2.16.1242. Copyright (C) 2013 American Megatrends, Inc.

```

BIOS Menu 10: iEi Feature

→ Auto Recovery Function [Disabled]

Use the **Auto Recovery Function** BIOS option to enable or disable the auto recovery function of the IEI One Key Recovery.

- **Disabled** **DEFAULT** Auto recovery function disabled
- **Enabled** Auto recovery function enabled

5.3.6 CPU Configuration

Use the **CPU Configuration** menu (**BIOS Menu 11**) to view detailed CPU specifications or enable the Intel Virtualization Technology.

```

Aptio Setup Utility - Copyright (C) 2013 American Megatrends, Inc.
  Advanced
CPU Information
Intel(R) Atom(TM) CPU E3845 @ 1.91GHz
CPU Signature           30679
Microcode Patch        90a
Max CPU Speed          1910 MHz
Min CPU Speed          500 MHz
Processor Cores        4
Intel HT Technology     Not Supported
Intel VT-x Technology   Supported

L1 Data Cache          24 kB x 4
L1 Code Cache          32 kB x 4
L2 Cache               1024 kB x 2
L3 Cache               Not Present
64-bit                 Supported

Intel Virtualization Technology [Disabled]
EIST                   [Enabled]
CPU C state Report     [Disabled]

When enabled, a VMM can utilize the additional hardware capabilities provided by Vanderpool Technology.

-----
-><: Select Screen
↑ ↓: Select Item
Enter: Select
+/-: Change Opt.
F1: General Help
F2: Previous Values
F3: Optimized Defaults
F4: Save & Exit
ESC: Exit

Version 2.16.1242. Copyright (C) 2013 American Megatrends, Inc.
  
```

BIOS Menu 11: CPU Configuration

➔ Intel Virtualization Technology [Disabled]

Use the **Intel Virtualization Technology** option to enable or disable virtualization on the system. When combined with third party software, Intel® Virtualization technology allows several OSs to run on the same system at the same time.

- ➔ **Disabled** **DEFAULT** Disables Intel Virtualization Technology.
- ➔ **Enabled** Enables Intel Virtualization Technology.

➔ **Serial-ATA (SATA) [Enabled]**

Use the **Serial-ATA (SATA)** option to configure the SATA controller.

- ➔ **Enabled** **DEFAULT** Enables the on-board SATA controller.
- ➔ **Disabled** Disables the on-board SATA controller.

➔ **SATA Mode [AHCI Mode]**

Use the **SATA Mode** option to configure SATA devices as normal IDE devices.

- ➔ **IDE Mode** Configures SATA devices as normal IDE device.
- ➔ **AHCI Mode** **DEFAULT** Configures SATA devices as AHCI device.

5.3.8 USB Configuration

Use the **USB Configuration** menu (**BIOS Menu 13**) to read USB configuration information and configure the USB settings.

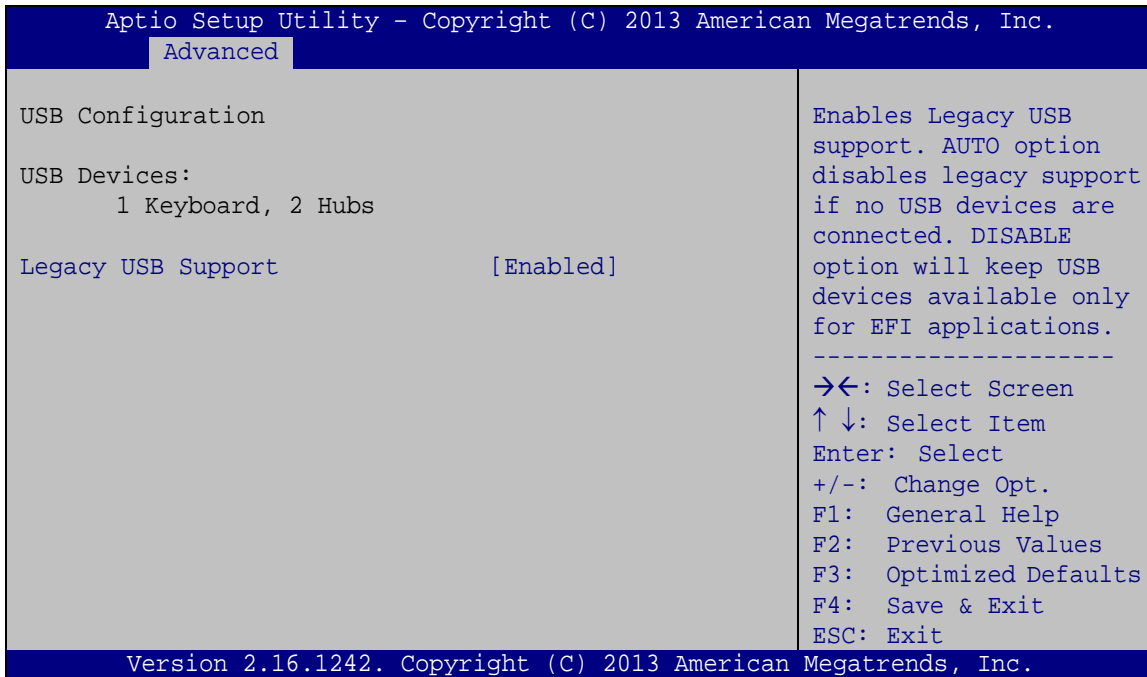

BIOS Menu 13: USB Configuration

WSB-BT CPU Card

→ USB Devices

The **USB Devices** field lists the USB devices that are enabled on the system

→ Legacy USB Support [Enabled]

Use the **Legacy USB Support** BIOS option to enable USB mouse and USB keyboard support. Normally if this option is not enabled, any attached USB mouse or USB keyboard does not become available until a USB compatible operating system is fully booted with all USB drivers loaded. When this option is enabled, any attached USB mouse or USB keyboard can control the system even when there is no USB driver loaded onto the system.

- | | | | |
|---|-----------------|----------------|---|
| → | Enabled | DEFAULT | Legacy USB support enabled |
| → | Disabled | | Legacy USB support disabled |
| → | Auto | | Legacy USB support disabled if no USB devices are connected |

5.4 Chipset

Use the **Chipset** menu (**BIOS Menu 14**) to access the North Bridge and South Bridge configuration menus.



WARNING!

Setting the wrong values for the Chipset BIOS selections in the Chipset BIOS menu may cause the system to malfunction.

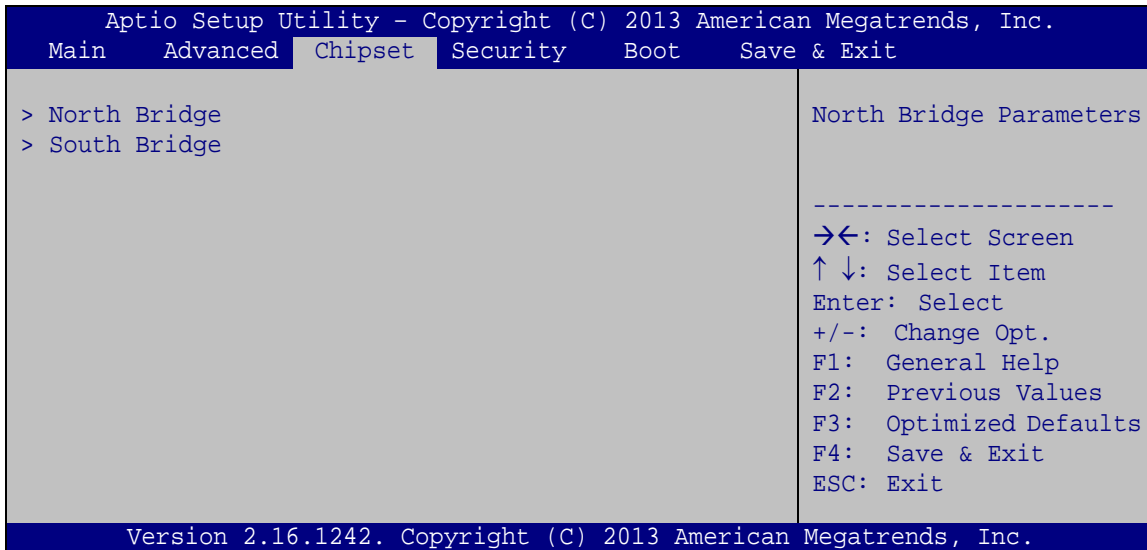

BIOS Menu 14: Chipset

5.4.1 North Bridge

Use the **North Bridge** menu (**BIOS Menu 15**) to configure the north bridge parameters.

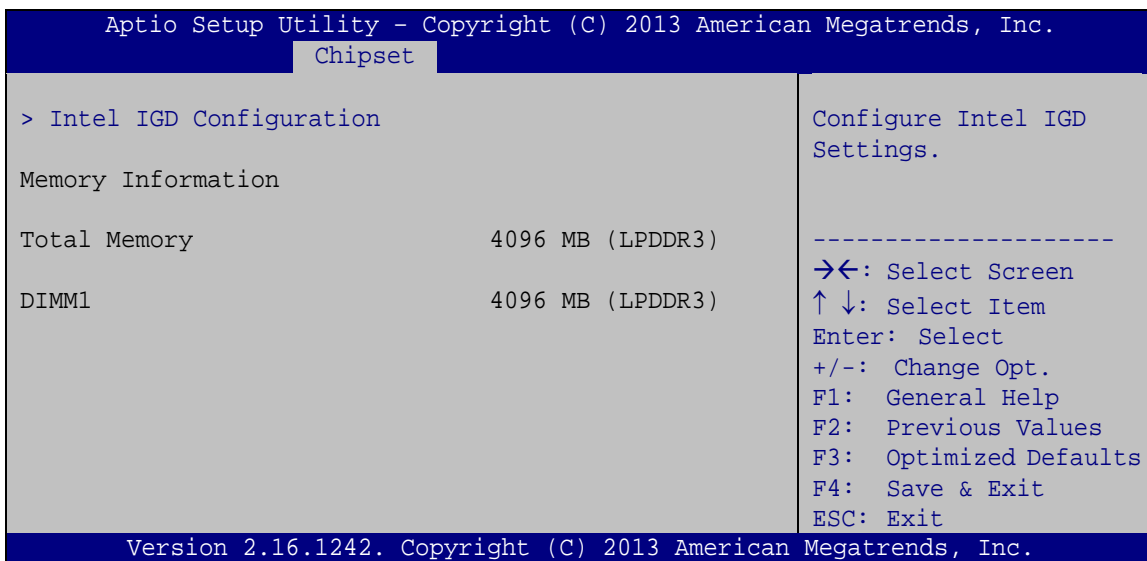

BIOS Menu 15: North Bridge

WSB-BT CPU Card

5.4.1.1 Intel IGD Configuration

Use the **Intel IGD Configuration** submenu (**BIOS Menu 16**) to configure the graphics settings.

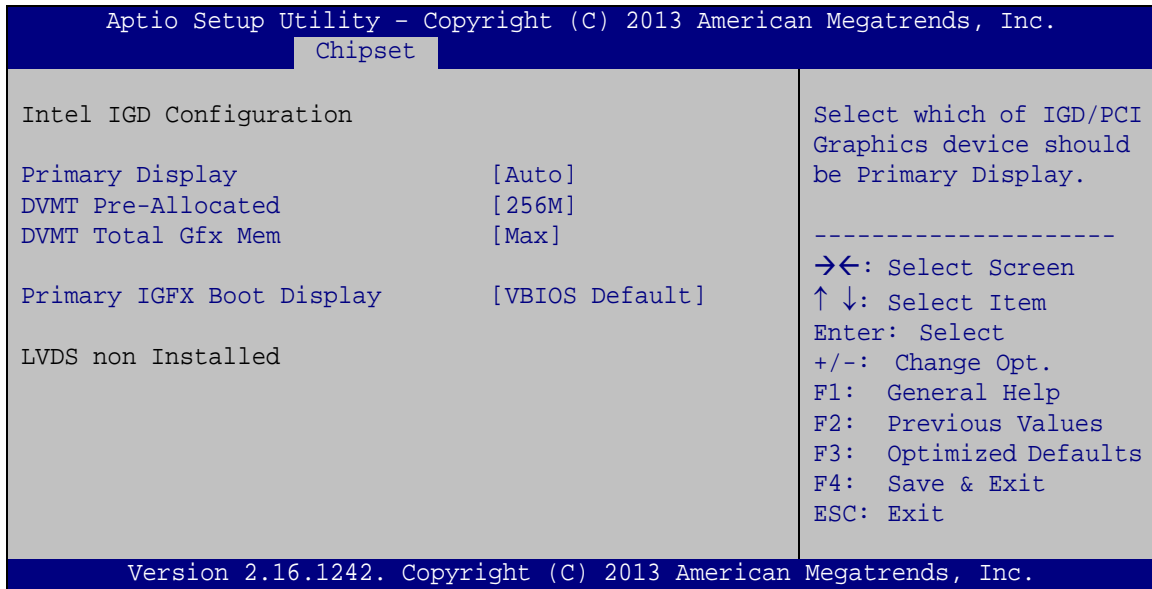

BIOS Menu 16: Intel IGD Configuration

→ Primary Display [Auto]

Use the **Primary Display** option to select the display device used by the system when it boots. Configuration options are listed below.

- Auto **DEFAULT**
- IGD
- PCI

→ DVMT Pre-Allocated [256M]

Use the **DVMT Pre-Allocated** option to specify the amount of system memory that can be used by the internal graphics device.

- **64M** 64 MB of memory used by internal graphics device
- **128M** 128 MB of memory used by internal graphics device

→ **256M** **DEFAULT** 256 MB of memory used by internal graphics device

→ **512M** 512 MB of memory used by internal graphics device

→ **DVMT Total Gfx Mem [Max]**

Use the **DVMT Total Gfx Mem** option to specify the maximum amount of memory that can be allocated as graphics memory. Configuration options are listed below.

- 128MB
- 256MB
- Max **DEFAULT**

→ **Primary IGFX Boot Display [VBIOS Default]**

Use the **Primary IGFX Boot Display** option to select the display device used by the system when it boots. Configuration options are listed below.

- VBIOS Default **DEFAULT**
- CRT
- DP1
- LVDS

WSB-BT CPU Card

5.4.2 South Bridge

Use the **South Bridge** menu (**BIOS Menu 17**) to configure the south bridge parameters.

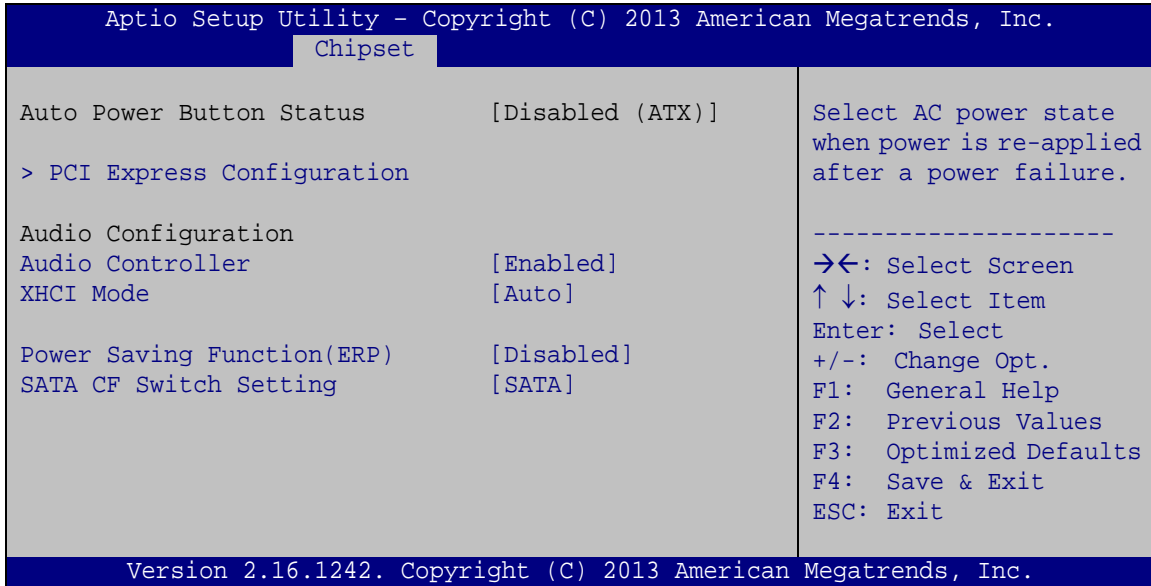

BIOS Menu 17: South Bridge

→ Audio Controller [Enabled]

Use the **Audio Controller** BIOS option to enable or disable the High Definition Audio controller.

- **Disabled** The High Definition Audio controller is disabled.
- **Enabled** **DEFAULT** The High Definition Audio controller is enabled.

→ XHCI Mode [Auto]

Use the **XHCI Mode** BIOS option to configure the USB xHCI (USB 3.1) controller.

- **Enabled** Enable the xHCI controller.
- **Disabled** Disable the xHCI controller.
- **Auto** **DEFAULT** Allow the use of USB 3.1 devices prior to OS boot. USB 3.1 ports function as USB 3.1 ports even during a reboot.

➔ **Power Saving Function(ERP) [Disabled]**

Use the **Power Saving Function(ERP)** BIOS option to enable or disable the power saving function.

- ➔ **Enabled** Power saving function is enabled. It will reduce power consumption when the system is off.
- ➔ **Disabled** **DEFAULT** Power saving function is disabled.

➔ **SATA CF Switch Setting [SATA]**

Use the **SATA CF Switch Setting** BIOS option to enable SATA2 device or CF card.

- ➔ **SATA** **DEFAULT** Enable SATA2 connector. The CompactFlash card slot will be disabled.
- ➔ **CF Card** Enable CompactFlash card slot. The SATA2 connector will be disabled.

5.4.2.1 PCI Express Configuration

Use the **PCI Express Configuration** submenu (**BIOS Menu 18**) to configure the PCIe Mini slot.

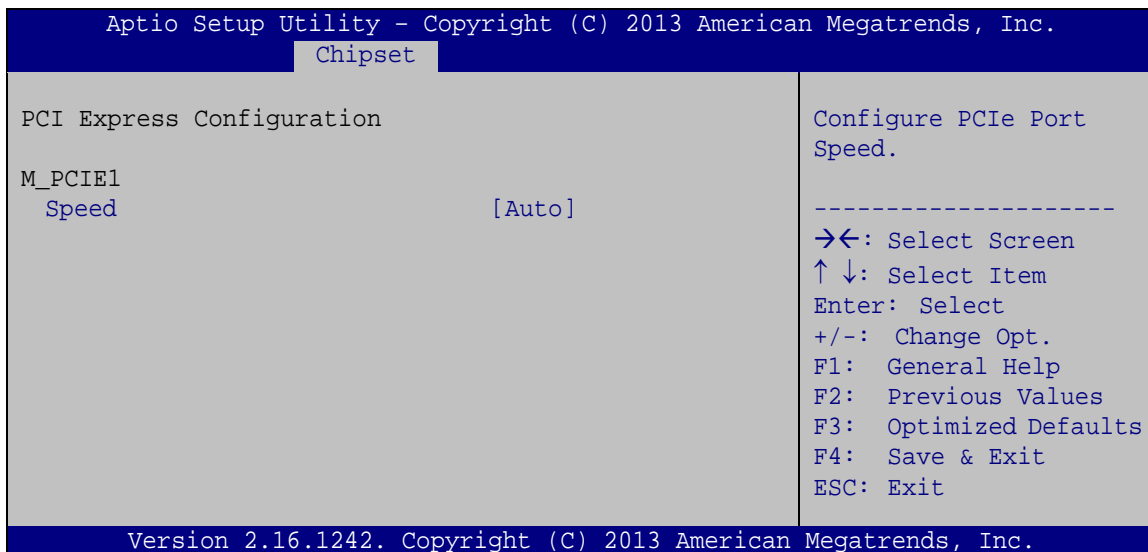

BIOS Menu 18: PCI Express Configuration

WSB-BT CPU Card

→ Speed [Auto]

Use the **Speed** option to configure the speed of PCIe Mini slot.

- Auto **DEFAULT**
- Gen 2
- Gen 1

5.5 Security

Use the **Security** menu (**BIOS Menu 19**) to set system and user passwords.

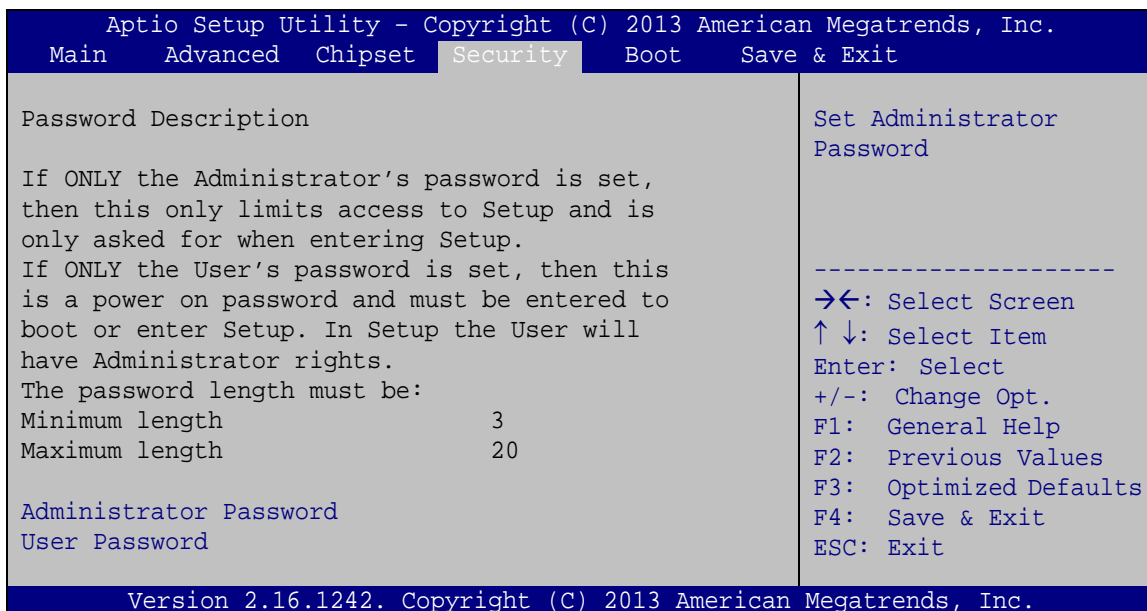

BIOS Menu 19: Security

→ Administrator Password

Use the **Administrator Password** to set or change a administrator password.

→ User Password

Use the **User Password** to set or change a user password.

5.6 Boot

Use the **Boot** menu (**BIOS Menu 20**) to configure system boot options.

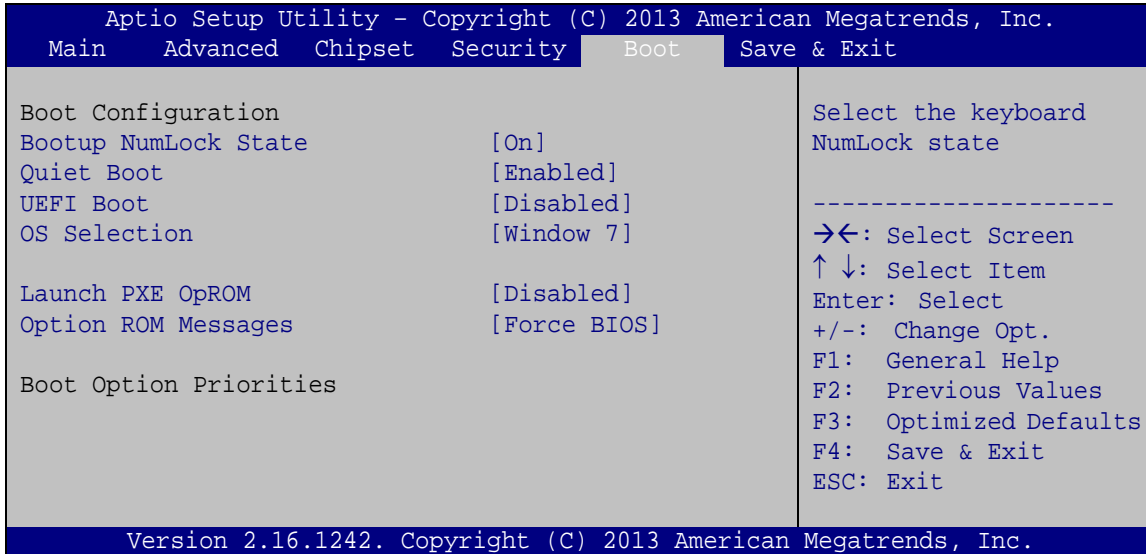

BIOS Menu 20: Boot

→ Bootup NumLock State [On]

Use the **Bootup NumLock State** BIOS option to specify if the number lock setting must be modified during boot up.

- **On** **DEFAULT** Allows the Number Lock on the keyboard to be enabled automatically when the computer system boots up. This allows the immediate use of the 10-key numeric keypad located on the right side of the keyboard. To confirm this, the Number Lock LED light on the keyboard is lit.

- **Off** Does not enable the keyboard Number Lock automatically. To use the 10-keys on the keyboard, press the Number Lock key located on the upper left-hand corner of the 10-key pad. The Number Lock LED on the keyboard lights up when the Number Lock is engaged.

WSB-BT CPU Card

→ Quiet Boot [Enabled]

Use the **Quiet Boot** BIOS option to select the screen display when the system boots.

- **Disabled** Normal POST messages displayed
- **Enabled** **DEFAULT** OEM Logo displayed instead of POST messages

→ UEFI Boot [Disabled]

Use the **UEFI Boot** option to enable or disable to boot from the UEFI devices.

- **Enabled** Boot from UEFI devices is enabled.
- **Disabled** **DEFAULT** Boot from UEFI devices is disabled.

→ OS Selection [Windows 7]

Use the **OS Selection** BIOS option to select an operating system (OS) before installing OS.

- **Windows 8.x** The system will be installed with Windows 8.x operating system.
- **Android** The system will be installed with Android operating system.
- **Windows 7** **DEFAULT** The system will be installed with Windows 7 operating system.



WARNING:

Before installing the operating system, the user must enter the **Boot** BIOS menu and choose which operating system will be installed. Otherwise, the OS installation may fail.

➔ **Launch PXE OpROM [Disabled]**

Use the **Launch PXE OpROM** option to enable or disable boot option for legacy network devices.

- ➔ **Disabled** **DEFAULT** Ignore all PXE Option ROMs
- ➔ **Enabled** Load PXE Option ROMs.

➔ **Option ROM Messages [Force BIOS]**

Use the **Option ROM Messages** option to set the Option ROM display mode.

- ➔ **Force BIOS** **DEFAULT** Sets display mode to force BIOS.
- ➔ **Keep Current** Sets display mode to current.

5.7 Save & Exit

Use the **Safe & Exit** menu (**BIOS Menu 21**) to load default BIOS values, optimal failsafe values and to save configuration changes.

```

Aptio Setup Utility - Copyright (C) 2013 American Megatrends, Inc.
Main   Advanced  Chipset  Security  Boot   Save & Exit
-----
Save Changes and Reset
Discard Changes and Reset

Restore Defaults
Save as User Defaults
Restore User Defaults

Exit the system after
saving the changes.

-----
-><: Select Screen
↑ ↓: Select Item
Enter: Select
+/-: Change Opt.
F1: General Help
F2: Previous Values
F3: Optimized Defaults
F4: Save & Exit
ESC: Exit

Version 2.16.1242. Copyright (C) 2013 American Megatrends, Inc.
    
```

BIOS Menu 21: Save & Exit

WSB-BT CPU Card

→ Save Changes and Reset

Use the **Save Changes and Reset** option to save the changes made to the BIOS options and reset the system.

→ Discard Changes and Reset

Use the **Discard Changes and Reset** option to exit the system without saving the changes made to the BIOS configuration setup program.

→ Restore Defaults

Use the **Restore Defaults** option to load the optimal default values for each of the parameters on the Setup menus. **F3 key can be used for this operation.**

→ Save as User Defaults

Use the **Save as User Defaults** option to save the changes done so far as user defaults.

→ Restore User Defaults

Use the **Restore User Defaults** option to restore the user defaults to all the setup options.

Chapter

6

Software Drivers

WSB-BT CPU Card

6.1 Available Drivers

All the drivers for the WSB-BT are available on IEI Resource Download Center (<https://download.ieiworld.com>). Type WSB-BT and press Enter to find all the relevant software, utilities, and documentation.

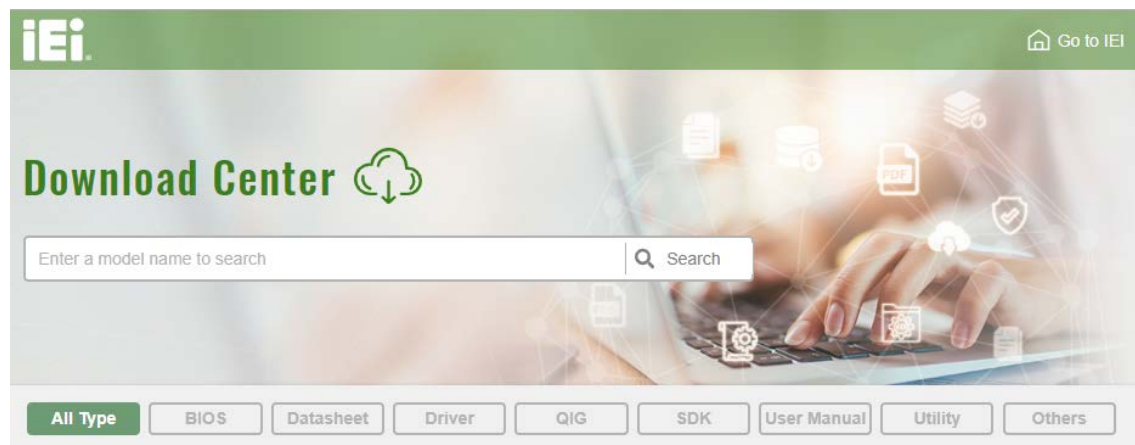
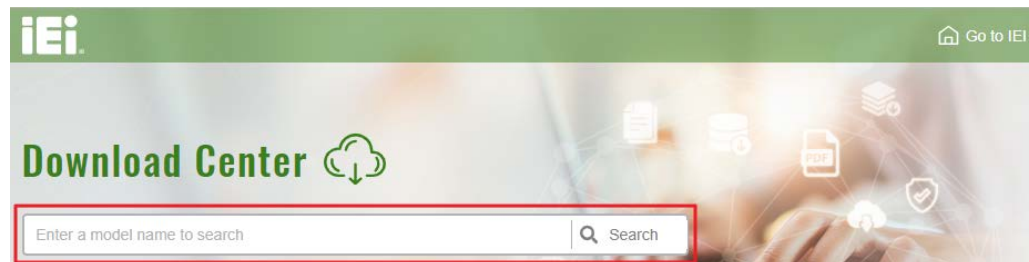

Figure 6-1: IEI Resource Download Center

6.2 Driver Download

To download drivers from IEI Resource Download Center, follow the steps below.

Step 1: Go to <https://download.ieiworld.com>. Type WSB-BT and press Enter.



Step 2: All product-related software, utilities, and documentation will be listed. You can choose **Driver** to filter the result.

[All Type](#)
[BIOS](#)
[Datasheet](#)
[Driver](#)
[QIG](#)
[SDK](#)
[User Manual](#)
[Utility](#)
[Others](#)

WAFER-BT-i1 [Product Info](#)

[Embedded Computer](#) ▶ [Single Board Computer](#) ▶ [Embedded Board](#)
 3.5" SBC with Intel® 22nm Atom™/Celeron® on-board SoC

Driver

File Name	Published	Version	File Checksum
7B000-001033-RS V2.3.iso (2.23 GB)	2017/10/03	2.30	3B2DB1F792779A93A8F50DDBC3943E30

Step 3: Click the driver file name on the page and you will be prompted with the following window. You can download the entire ISO file (❶), or click the small arrow to find an individual driver and click the file name to download (❷).

7B000-001168-RS_V1.4.iso

❶ [Click here to download entire ISO file. \(2.99 GB\)](#)

* Download individual file *

- Docs
 - 1.Chipset
 - 10.1.1.12.zip (2.7 MB)
 - 2.VGA
 - 3.Audio
 - 4.Lan
 - 5.USB 3.0
 - 6.Serial IO
 - 7.TXE
 - 8.Manual

❷



NOTE:

To install software from the downloaded ISO image file in Windows 8, 8.1 or 10, double-click the ISO file to mount it as a virtual drive to view its content. On Windows 7 system, an additional tool (such as Virtual CD-ROM Control Panel from Microsoft) is needed to mount the file.

WSB-BT CPU Card



NOTE:

The Intel TXE requires that Microsoft's "Kernel-Mode Driver Framework (KMDF) version 1.11 update for Windows 7" is installed first. If the KMDF is not installed, either error 37 or error 28 may appear on the Intel TXE device in Device Manager.

Click the following link to download the KMDF version 1.11 update for Windows 7:

<http://www.microsoft.com/en-us/download/details.aspx?id=38423>

Appendix

A

Regulatory Compliance

DECLARATION OF CONFORMITY



This equipment has been tested and found to comply with specifications for CE marking. If the user modifies and/or installs other devices in the equipment, the CE conformity declaration may no longer apply.

FCC WARNING



This equipment complies with Part 15 of the FCC Rules. Operation is subject to the following two conditions:

- This device may not cause harmful interference, and
- This device must accept any interference received, including interference that may cause undesired operation.

This equipment has been tested and found to comply with the limits for a Class A digital device, pursuant to part 15 of the FCC Rules. These limits are designed to provide reasonable protection against harmful interference when the equipment is operated in a commercial environment. This equipment generates, uses, and can radiate radio frequency energy and, if not installed and used in accordance with the instruction manual, may cause harmful interference to radio communications. Operation of this equipment in a residential area is likely to cause harmful interference in which case the user will be required to correct the interference at his own expense.

Appendix

B

Product Disposal

WSB-BT CPU Card



CAUTION:

Risk of explosion if battery is replaced by an incorrect type. Only certified engineers should replace the on-board battery.

Dispose of used batteries according to instructions and local regulations.

- Outside the European Union–If you wish to dispose of used electrical and electronic products outside the European Union, please contact your local authority so as to comply with the correct disposal method.
- Within the European Union–The device that produces less waste and is easier to recycle is classified as electronic device in terms of the European Directive 2012/19/EU (WEEE), and must not be disposed of as domestic garbage.

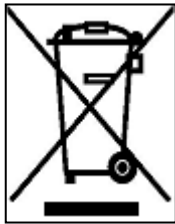

EU-wide legislation, as implemented in each Member State, requires that waste electrical and electronic products carrying the mark (left) must be disposed of separately from normal household waste. This includes monitors and electrical accessories, such as signal cables or power cords. When you need to dispose of your device, please follow the guidance of your local authority, or ask the shop where you purchased the product. The mark on electrical and electronic products only applies to the current European Union Member States.

Please follow the national guidelines for electrical and electronic product disposal.

Appendix

C

BIOS Options

WSB-BT CPU Card

Below is a list of BIOS configuration options in the BIOS chapter.

<input type="checkbox"/>	System Date [xx/xx/xx]	72
<input type="checkbox"/>	System Time [xx:xx:xx]	72
<input type="checkbox"/>	Security Device Support [Disable]	74
<input type="checkbox"/>	Serial Port [Enabled]	76
<input type="checkbox"/>	Change Settings [Auto]	76
<input type="checkbox"/>	Transfer Mode [RS232]	77
<input type="checkbox"/>	Serial Port [Enabled]	77
<input type="checkbox"/>	Change Settings [Auto]	77
<input type="checkbox"/>	Transfer Mode [RS232]	78
<input type="checkbox"/>	Serial Port [Enabled]	78
<input type="checkbox"/>	Change Settings [Auto]	78
<input type="checkbox"/>	Serial Port [Enabled]	79
<input type="checkbox"/>	Change Settings [Auto]	79
<input type="checkbox"/>	Serial Port [Enabled]	80
<input type="checkbox"/>	Change Settings [Auto]	80
<input type="checkbox"/>	Serial Port [Enabled]	81
<input type="checkbox"/>	Change Settings [Auto]	81
<input type="checkbox"/>	Parallel Port [Enabled]	82
<input type="checkbox"/>	Change Settings [Auto]	82
<input type="checkbox"/>	Device Mode [STD Printer Mode]	83
<input type="checkbox"/>	PC Health Status	84
<input type="checkbox"/>	CPU_FAN1 Smart Fan Control/SYS_FAN1 Smart Fan Control [Auto Mode]	85
<input type="checkbox"/>	Auto mode fan start/off temperature	85
<input type="checkbox"/>	Auto mode fan start PWM	86
<input type="checkbox"/>	Auto mode fan slope PWM	86
<input type="checkbox"/>	Console Redirection [Disabled]	87
<input type="checkbox"/>	Terminal Type [ANSI]	87
<input type="checkbox"/>	Bits per second [115200]	87
<input type="checkbox"/>	Data Bits [8]	87
<input type="checkbox"/>	Parity [None]	88
<input type="checkbox"/>	Stop Bits [1]	88
<input type="checkbox"/>	Auto Recovery Function [Disabled]	89
<input type="checkbox"/>	Intel Virtualization Technology [Disabled]	90

<input type="checkbox"/> EIST [Enabled].....	91
<input type="checkbox"/> CPU C State Report [Disabled].....	91
<input type="checkbox"/> Serial-ATA (SATA) [Enabled].....	92
<input type="checkbox"/> SATA Mode [AHCI Mode].....	92
<input type="checkbox"/> USB Devices.....	93
<input type="checkbox"/> Legacy USB Support [Enabled].....	93
<input type="checkbox"/> Primary Display [Auto].....	95
<input type="checkbox"/> DVMT Pre-Allocated [256M].....	95
<input type="checkbox"/> DVMT Total Gfx Mem [Max].....	96
<input type="checkbox"/> Primary IGFX Boot Display [VBIOS Default].....	96
<input type="checkbox"/> Audio Controller [Enabled].....	97
<input type="checkbox"/> XHCI Mode [Auto].....	97
<input type="checkbox"/> Power Saving Function(ERP) [Disabled].....	98
<input type="checkbox"/> SATA CF Switch Setting [SATA].....	98
<input type="checkbox"/> Speed [Auto].....	99
<input type="checkbox"/> Administrator Password.....	99
<input type="checkbox"/> User Password.....	99
<input type="checkbox"/> Bootup NumLock State [On].....	100
<input type="checkbox"/> Quiet Boot [Enabled].....	101
<input type="checkbox"/> UEFI Boot [Disabled].....	101
<input type="checkbox"/> OS Selection [Windows 7].....	101
<input type="checkbox"/> Launch PXE OpROM [Disabled].....	102
<input type="checkbox"/> Option ROM Messages [Force BIOS].....	102
<input type="checkbox"/> Save Changes and Reset.....	103
<input type="checkbox"/> Discard Changes and Reset.....	103
<input type="checkbox"/> Restore Defaults.....	103
<input type="checkbox"/> Save as User Defaults.....	103
<input type="checkbox"/> Restore User Defaults.....	103

Appendix

D

Digital I/O Interface

D.1 Introduction

The DIO connector on the WSB-BT is interfaced to GPIO ports on the Super I/O chipset. The digital inputs and digital outputs are generally control signals that control the on/off circuit of external devices or TTL devices. Data can be read or written to the selected address to enable the DIO functions.



NOTE:

For further information, please refer to the datasheet for the Super I/O chipset.

The BIOS interrupt call **INT 15H** controls the digital I/O.

INT 15H:

AH – 6FH	
<u>Sub-function:</u>	
AL – 8	: Set the digital port as INPUT
AL	: Digital I/O input value

WSB-BT CPU Card

D.2 Assembly Language Sample 1

```

MOV     AX, 6F08H      ;setting the digital port as input
INT     15H           ;

```

AL low byte = value

AH – 6FH
<u>Sub-function:</u>
AL – 9 : Set the digital port as OUTPUT
BL : Digital I/O input value

D.3 Assembly Language Sample 2

```

MOV     AX, 6F09H      ;setting the digital port as output
MOV     BL, 09H        ;digital value is 09H
INT     15H           ;

```

Digital Output is 1001b

Appendix

E

Watchdog Timer

WSB-BT CPU Card



NOTE:

The following discussion applies to DOS environment. Contact IEI support or visit the IEI website for specific drivers for other operating systems.

The Watchdog Timer is provided to ensure that standalone systems can always recover from catastrophic conditions that cause the CPU to crash. This condition may have occurred by external EMIs or a software bug. When the CPU stops working correctly, Watchdog Timer either performs a hardware reset (cold boot) or a Non-Maskable Interrupt (NMI) to bring the system back to a known state.

A BIOS function call (INT 15H) is used to control the Watchdog Timer.

INT 15H:

AH – 6FH Sub-function:	
AL – 2:	Sets the Watchdog Timer's period.
BL:	Time-out value (Its unit-second is dependent on the item "Watchdog Timer unit select" in CMOS setup).

Table E-1: AH-6FH Sub-function

Call sub-function 2 to set the time-out period of Watchdog Timer first. If the time-out value is not zero, the Watchdog Timer starts counting down. When the timer value reaches zero, the system resets. To ensure that this reset condition does not occur, calling sub-function 2 must periodically refresh the Watchdog Timer. However, the watchdog timer is disabled if the time-out value is set to zero.

A tolerance of at least 10% must be maintained to avoid unknown routines within the operating system (DOS), such as disk I/O that can be very time-consuming.

**NOTE:**

When exiting a program it is necessary to disable the Watchdog Timer, otherwise the system resets.

EXAMPLE PROGRAM:

```
; INITIAL TIMER PERIOD COUNTER
```

```
;
```

```
W_LOOP:
```

```
;
```

```
    MOV     AX, 6F02H      ;setting the time-out value  
    MOV     BL, 30        ;time-out value is 48 seconds  
    INT     15H
```

```
;
```

```
; ADD THE APPLICATION PROGRAM HERE
```

```
;
```

```
    CMP     EXIT_AP, 1    ;is the application over?  
    JNE     W_LOOP       ;No, restart the application
```

```
    MOV     AX, 6F02H     ;disable Watchdog Timer  
    MOV     BL, 0        ;  
    INT     15H
```

```
;
```

```
; EXIT ;
```

Appendix

F

Hazardous Materials Disclosure

The details provided in this appendix are to ensure that the product is compliant with the Peoples Republic of China (China) RoHS standards. The table below acknowledges the presences of small quantities of certain materials in the product, and is applicable to China RoHS only.

A label will be placed on each product to indicate the estimated “Environmentally Friendly Use Period” (EFUP). This is an estimate of the number of years that these substances would “not leak out or undergo abrupt change.” This product may contain replaceable sub-assemblies/components which have a shorter EFUP such as batteries and lamps. These components will be separately marked.

Please refer to below table.

Part Name	Toxic or Hazardous Substances and Elements					
	Lead (Pb)	Mercury (Hg)	Cadmium (Cd)	Hexavalent Chromium (CR(VI))	Polybrominated Biphenyls (PBB)	Polybrominated Diphenyl Ethers (PBDE)
Housing	O	O	O	O	O	O
Display	O	O	O	O	O	O
Printed Circuit Board	O	O	O	O	O	O
Metal Fasteners	O	O	O	O	O	O
Cable Assembly	O	O	O	O	O	O
Fan Assembly	O	O	O	O	O	O
Power Supply Assemblies	O	O	O	O	O	O
Battery	O	O	O	O	O	O

O: This toxic or hazardous substance is contained in all of the homogeneous materials for the part is below the limit requirement in SJ/T11363-2006 (now replaced by GB/T 26572-2011).

X: This toxic or hazardous substance is contained in at least one of the homogeneous materials for this part is above the limit requirement in SJ/T11363-2006 (now replaced by GB/T 26572-2011).

WSB-BT CPU Card

此附件旨在确保本产品符合中国 RoHS 标准。以下表格标示此产品中某有毒物质的含量符合中国 RoHS 标准规定的限量要求。

本产品上会附有“环境友好使用期限”的标签，此期限是估算这些物质“不会有泄漏或突变”的年限。本产品可能包含有较短的环境友好使用期限的可替换元件，像是电池或灯管，这些元件将会单独标示出来。

部件名称	有毒有害物质或元素					
	铅 (Pb)	汞 (Hg)	镉 (Cd)	六价铬 (CR(VI))	多溴联苯 (PBB)	多溴二苯 醚 (PBDE)
壳体	○	○	○	○	○	○
显示	○	○	○	○	○	○
印刷电路板	○	○	○	○	○	○
金属螺帽	○	○	○	○	○	○
电缆组装	○	○	○	○	○	○
风扇组装	○	○	○	○	○	○
电力供应组装	○	○	○	○	○	○
电池	○	○	○	○	○	○

○: 表示该有毒有害物质在该部件所有物质材料中的含量均在 SJ/T11363-2006 (现由 GB/T 26572-2011 取代) 标准规定的限量要求以下。

X: 表示该有毒有害物质至少在该部件的某一均质材料中的含量超出 SJ/T11363-2006 (现由 GB/T 26572-2011 取代) 标准规定的限量要求。