



MODEL:
PUZZLE-IN001

1U Network Appliance with 8th Gen. Intel® Core™ i3, Pentium®, Celeron® and Intel® Xeon® E Processor, DDR4, Eight GbE Ports, Two PCIe Slots, M.2, PCIe Mini, Redundant PSU, Rack Mount, and RoHS Compliant

User Manual

Revision

Date	Version	Changes
October 15, 2021	1.10	Updated for R11 version. Modified Section 3.15.1: Power Supply Unit Replacement
November 6, 2020	1.04	Modified Section 1.4 Front Panel Updated Section 3.7 IEI Networking Module Installation
September 1, 2020	1.03	Added Section 3.4 CPU Installation (PUZZLE-IN001-R Only) Added username and password information for system login in Section 3.13 Power-On Procedure. Added Section 3.11.1 Enable Console Port When Booting Modified Section 3.12 Rack Mount Modified storage temperature
November 19, 2019	1.02	Added: Section 1.6.1 Expansion Slot Block Diagram Section 3.7.1 Bypass Configuration in BIOS Section 5.2.18 IEI Networking Module Slot A Section 5.2.19 IEI Networking Module Slot B Updated: Section 3.7 IEI Networking Module Installation
February 19, 2019	1.01	Minor update
January 8, 2019	1.00	Initial release

Copyright

COPYRIGHT NOTICE

The information in this document is subject to change without prior notice in order to improve reliability, design and function and does not represent a commitment on the part of the manufacturer.

In no event will the manufacturer be liable for direct, indirect, special, incidental, or consequential damages arising out of the use or inability to use the product or documentation, even if advised of the possibility of such damages.

This document contains proprietary information protected by copyright. All rights are reserved. No part of this manual may be reproduced by any mechanical, electronic, or other means in any form without prior written permission of the manufacturer.

TRADEMARKS

All registered trademarks and product names mentioned herein are used for identification purposes only and may be trademarks and/or registered trademarks of their respective owners.

Manual Conventions



WARNING

Warnings appear where overlooked details may cause damage to the equipment or result in personal injury. Warnings should be taken seriously.



CAUTION

Cautionary messages should be heeded to help reduce the chance of losing data or damaging the product.



NOTE

These messages inform the reader of essential but non-critical information. These messages should be read carefully as any directions or instructions contained therein can help avoid making mistakes.

Table of Contents

1 INTRODUCTION.....	11
1.1 OVERVIEW.....	12
1.2 MODEL VARIATIONS	13
1.3 FEATURES.....	13
1.4 FRONT PANEL.....	14
1.5 REAR PANEL	14
1.6 TECHNICAL SPECIFICATIONS	15
1.6.1 <i>Expansion Slot Block Diagram</i>	17
1.7 DIMENSIONS.....	18
2 UNPACKING	19
2.1 ANTI-STATIC PRECAUTIONS.....	20
2.2 UNPACKING PRECAUTIONS.....	20
2.3 PACKING LIST	21
2.4 OPTIONAL ITEMS.....	22
3 INSTALLATION	23
3.1 INSTALLATION PRECAUTIONS	24
3.2 TOP COVER REMOVAL.....	25
3.3 DIMM INSTALLATION	26
3.4 CPU INSTALLATION (PUZZLE-IN001-R ONLY).....	27
3.4.1 <i>CPU Heatsink Installation (PUZZLE-IN001-R Only)</i>	30
3.5 HDD INSTALLATION.....	31
3.6 PCIe EXPANSION CARD INSTALLATION	33
3.7 IEI NETWORKING MODULE INSTALLATION	37
3.7.1 <i>Bypass Configuration in BIOS</i>	38
3.8 M.2 MODULE INSTALLATION.....	40
3.9 PCIe MINI CARD INSTALLATION	41
3.9.1 <i>Half-size PCIe Mini Card Installation</i>	42
3.10 LAN CONNECTION.....	42
3.11 CONSOLE CONNECTION.....	43

3.11.1 Enable Console Port When Booting.....	44
3.12 RACK MOUNT	46
3.13 POWER-ON PROCEDURE.....	47
3.14 AVAILABLE DRIVERS.....	48
3.14.1 Driver Download	49
3.15 MAINTENANCE.....	50
3.15.1 Power Supply Unit Replacement	51
3.15.2 Jumper Settings.....	52
3.15.2.1 Clear CMOS.....	52
3.15.2.2 Flash Descriptor Security Override Jumper.....	53
4 BIOS.....	55
4.1 INTRODUCTION.....	56
4.1.1 Starting Setup.....	56
4.1.2 Using Setup	56
4.1.3 Getting Help.....	57
4.1.4 Unable to Reboot after Configuration Changes	57
4.1.5 BIOS Menu Bar.....	57
4.2 MAIN.....	58
4.3 ADVANCED.....	59
4.3.1 CPU Configuration	60
4.3.2 Trusted Computing.....	61
4.3.3 iWDD H/W Monitor.....	62
4.3.3.1 Smart Fan Mode Configuration	63
4.3.4 IT8528 Super IO Configuration	65
4.3.4.1 Serial Port 1 Configuration	65
4.3.5 Serial Port Console Redirection	66
4.3.5.1 Legacy Console Redirection Settings	68
4.3.6 NVMe Configuration.....	69
4.4 CHIPSET	70
4.4.1 System Agent (SA) Configuration	71
4.4.1.1 Memory Configuration	72
4.4.1.2 Graphics Configuration.....	72
4.4.1.3 PEG Port Configuration.....	74
4.4.2 PCH-IO Configuration	75

PUZZLE-IN001

4.4.2.1 PCI Express Configuration	76
4.4.2.2 SATA and RST Configuration.....	78
4.4.2.3 Network Configuration (Bypass Setting).....	80
4.5 SECURITY.....	81
4.6 BOOT.....	82
4.7 SAVE & EXIT	84
5 INTERFACE CONNECTORS	85
5.1 PERIPHERAL INTERFACE CONNECTORS.....	86
5.2 INTERNAL PERIPHERAL CONNECTORS	87
5.2.1 ATX Power Connector (ATX1).....	88
5.2.2 ATX PSU SMBus Connector (CN3).....	88
5.2.3 CPU Power Connector (CPU12V1)	88
5.2.4 Chassis Intrusion Connector (CHASSIS1).....	89
5.2.5 DIO Connector (DIO1).....	89
5.2.6 EC Debug Connector (CN1).....	89
5.2.7 Fan Connectors (CPU_FAN1/2/3/4).....	90
5.2.8 LCM Connector (CN2)	90
5.2.9 LAN LED Connector (LED_LAN1/2/3/4/5/6/7/8)	90
5.2.10 M.2 Slot (M2_1).....	91
5.2.11 PCIe Mini Card Slot (MPCIE1).....	92
5.2.12 Power Button Connector (PWR_BTN2)	93
5.2.13 SATA Connector (PCIEX1_SLOT1).....	93
5.2.14 SPI Flash Connector (JSPI1).....	94
5.2.15 SPI Flash Connector - EC (JSPI2)	94
5.2.16 TPM Connector (TPM1).....	95
5.2.17 USB 2.0 Connector (USB1)	95
5.2.18 IEI Networking Module Slot A.....	96
5.2.19 IEI Networking Module Slot B.....	98
A REGULATORY COMPLIANCE	100
B SAFETY PRECAUTIONS	105
B.1 SAFETY PRECAUTIONS.....	106
B.1.1 General Safety Precautions	106
B.1.2 Anti-static Precautions	107

<i>B.1.3 Product Disposal</i>	108
B.2 MAINTENANCE AND CLEANING PRECAUTIONS	109
<i>B.2.1 Maintenance and Cleaning</i>	109
<i>B.2.2 Cleaning Tools</i>	109
C ERROR BEEP CODE	111
C.1 PEI BEEP CODES	112
C.2 DXE BEEP CODES	112
D HAZARDOUS MATERIALS DISCLOSURE	113
D.1 RoHS II DIRECTIVE (2015/863/EU)	114
D.2 CHINA RoHS.....	115

List of Figures

Figure 1-1: PUZZLE-IN001 Series.....	12
Figure 1-2: PUZZLE-IN001 Front Panel.....	14
Figure 1-3: PUZZLE-IN001 Rear Panel.....	14
Figure 1-4: Expansion Slot Block Diagram.....	17
Figure 1-5: Physical Dimensions (millimeters).....	18
Figure 3-1: Top Cover Removal	25
Figure 3-2: DIMM Slot Locations.....	26
Figure 3-3: Disengage the CPU Socket Load Lever.....	27
Figure 3-4: Remove Protective Cover.....	28
Figure 3-5: Insert the Socket LGA1155 CPU.....	29
Figure 3-6: Close the Socket LGA1155	29
Figure 3-7: CPU Heatsink Installation.....	31
Figure 3-8: HDD Bracket Retention Screws.....	32
Figure 3-9: Secure HDD to the Bracket	32
Figure 3-10: HDD Installation	33
Figure 3-11: Expansion Slot Module Retention Screws	34
Figure 3-12: Disconnect the Expansion Slot Module.....	34
Figure 3-13: Blank Bracket Screw.....	35
Figure 3-14: PCIe Expansion Card Installation.....	35
Figure 3-15: Expansion Slot Module Installation	36
Figure 3-16: Networking Module Slot Cover Screws	37
Figure 3-17: Networking Module Installation.....	38
Figure 3-18: PCIe Mini Slot Location	41
Figure 3-19: RJ-45 Ethernet Connector.....	42
Figure 3-20: Rack Mount Bracket Installation	46
Figure 3-21: Power-on.....	47
Figure 3-22: IEI Resource Download Center.....	48
Figure 3-23: Clear CMOS Button Location.....	53
Figure 3-24: Flash Descriptor Security Override Jumper Location	54

List of Tables

Table 1-1: PUZZLE-IN001 Model Variations	13
Table 1-2: Technical Specifications.....	16
Table 3-1: LAN Pinouts	42
Table 3-2: RJ-45 Ethernet Connector LEDs	43
Table 3-3: RJ-45 Serial Port Pinouts.....	43
Table 3-4: Flash Descriptor Security Override Jumper Settings.....	53
Table 4-1: BIOS Navigation Keys	57
Table 5-1: Peripheral Interface Connectors	87
Table 5-2: ATX Power Connector Pinouts	88
Table 5-3: ATX PSU SMBus Connector (CN3) Pinouts.....	88
Table 5-4: CPU Power Connector (CPU12V1) Pinouts.....	89
Table 5-5: Chassis Intrusion Connector (CHASSIS1) Pinouts.....	89
Table 5-6: DIO Connector (DIO1) Pinouts	89
Table 5-7: EC Debug Connector (CN1) Pinouts.....	90
Table 5-8: Fan Connectors (CPU_FAN1/2/3/4) Pinouts.....	90
Table 5-9: LCM Connector (CN2) Pinouts	90
Table 5-10: LAN LED Connector (LED_LAN1/2/3/4/5/6/7/8) Pinouts.....	91
Table 5-11: M.2 Slot (M2_1) Pinouts	92
Table 5-12: PCIe Mini Card Slot (MPCIE1) Pinouts	93
Table 5-13: Power Button Connector (PWR_BTN2) Pinouts.....	93
Table 5-14: SATA 6Gb/s Connector (PCIEX1_SLOT1) Pinouts.....	94
Table 5-15: SPI Flash Connector (JSPI1) Pinouts	94
Table 5-16: SPI Flash Connector - EC (JSPI2) Pinouts.....	94
Table 5-17: TPM Connector (TPM1) Pinouts.....	95
Table 5-18: USB 2.0 Connector (USB1) Pinouts.....	95
Table 5-19: IEI Networking Module Slot A Pinouts	97
Table 5-20: IEI Networking Module Slot B Pinouts	99
Table 5-21: PCIe Link Configuration.....	99

Chapter

1

Introduction

1.1 Overview



Figure 1-1: PUZZLE-IN001 Series

The PUZZLE-IN001 is a 1 U network appliance series powered by the 8th generation Intel® Xeon®, Core™ i3, Pentium® or Celeron® processor. It is optimized to host VNFs (Virtual Network Functions) and is ideal for SD-WAN.

The PUZZLE-IN001 supports 8 copper GbE ports for high-speed network applications, and it is equipped with a PCIe x8 slot and a PCIe x4 slot for upgrading with expansion cards, such as NIC cards or accelerator cards. Multiple storage interfaces for fast and stable data transmission are offered through two SATA 6Gb/s connectors and one PCIe Mini slot that supports mSATA module.



WARNING:

This equipment is not suitable for use in locations where children are likely to be present.

PUZZLE-IN001

1.2 Model Variations

The model variations of the PUZZLE-IN001 are listed below.

PUZZLE-IN001	CPU	Memory	SSD
-R*	N/A	N/A	N/A
-i3T/R	Intel® Core™ i3-8100T	N/A	N/A
-i3T/16G/R	Intel® Core™ i3-8100T	16 GB	256 GB
-XE/R	Intel® Xeon® E-2136	N/A	N/A
-XE/16G/R	Intel® Xeon® E-2136	16 GB	256 GB
*A CPU heatsink must be purchased separately for the PUZZLE-IN001-R. Refer to Section 2.4.			

Table 1-1: PUZZLE-IN001 Model Variations

1.3 Features

The PUZZLE-IN001 features are listed below:

- Powered by 8th gen Intel® Xeon®, Core™ i3, Pentium® or Celeron® processor
- Support two 2400 MHz DDR4 ECC/non-ECC RDIMMs (system max. 32 GB)
- Support two 2.5" SATA SSD/HDD
- Support up to eight GbE connections via Intel® I211 controllers
- Upgradable with future expansion cards by one PCIe x8 slot, one PCIe x4 slot, one M.2 B-key slot and one PCIe Mini card slot
- One RJ-45 console port
- Supports two USB 3.2 Gen 1 (5 Gb/s) ports
- 1U chassis for rack mounting
- CE, FCC and RoHS compliant

1.4 Front Panel

The overview of the front panel is shown in **Figure 1-2**.

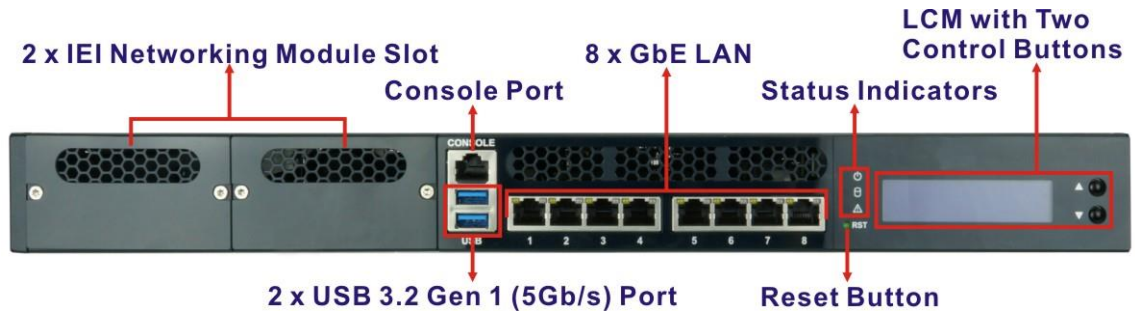

Figure 1-2: PUZZLE-IN001 Front Panel

The states of the LED indicators located on the front panel are listed below.

 Power LED	Off	The system is turned off.
	Blue	The system is turned on.
 HDD Status LED	Off	No HDD activity
	Blinking Green	HDD activity
 Alert LED	Off	No alert
	Red	Alert message

1.5 Rear Panel

An overview of the PUZZLE-IN001 rear panel is shown in **Figure 1-3** below.

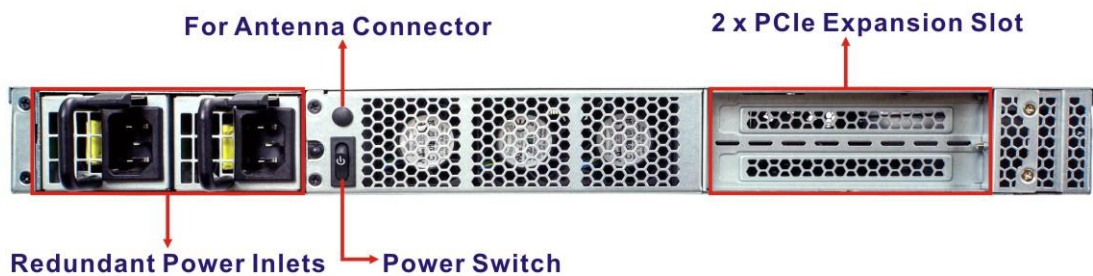

Figure 1-3: PUZZLE-IN001 Rear Panel

PUZZLE-IN001

1.6 Technical Specifications

The PUZZLE-IN001 technical specifications are listed in **Table 1-2**.

System	
Form Factor	1U
CPU (SoC)	8 th gen Intel® Xeon®, Core™ i3, Pentium® or Celeron® processor XE SKU: 8 th gen Intel® Xeon® E-2136 processor i3T SKU: 8 th gen Intel® Core™ i3-8100T processor
Chipset	Intel® C246
Memory	Two 288-pin 2400 MHz DDR4 ECC/non-ECC RDIMM slots (system max. 32 GB) (16G SKUs are pre-installed with two 8 GB memory modules)
Networking	Intel® I211-AT Ethernet controller 8 x Copper 1GbE LAN port 2 x PCIe slot for IEI networking module (Slot A & Slot B)
Network Acceleration and Security	Intel® AES New Instructions Intel® Software Guard Extensions (Intel® SGX) Intel® Memory Protection Extensions (Intel® MPX) Intel® Trusted Execution Technology
Storage	2 x 2.5" SATA 6Gb/s HDD/SSD bay
Expansion	
PCIe	1 x PCIe 3.0 x4 slot (FHHL) 1 x PCIe 3.0 x8 slot (FHHL)
PCIe Mini	1 x Full-size/Half-size PCIe Mini slot (PCIe 3.0 & SATA 6Gb/s, USB 2.0)
M.2	1 x M.2 B-key 2260/3042 slot (SATA 6Gb/s, USB 3.2 Gen 1) Support SATA SSD and 4G LTE module
I/O and Indicators	
Console	1 x RJ-45
USB	2 x USB 3.2 Gen 1 (5 Gb/s) port (external) 4 x USB 2.0 internal pin-header (8-pin, p=2.54)

Indicator	LCM (with two control buttons) Power status (blue) HDD status (green) Alert LED (programmable, red)
Switch/Button	Power switch (rear panel) Reset button (front panel)
TPM	1 x TPM 2.0 (2x10 pin header)
Antenna Connector	1 x Knockout hole for antenna connector
Power	
Power Input	100 V ~ 240 V, 5 A ~ 2.5 A, 60 Hz ~ 50 Hz
Type/Watt	300 W redundant power
Thermal Solution	1 x Passive heat sink for CPU 3 x Smart fan for CPU 1 x Smart fan for system
Environmental and Mechanical	
Mounting	1U rack mount
Operating Temperature	0°C~40°C (32°F~104°F)
Storage Temperature	-20°C~75°C (-4°F~167°F)
Operating Humidity	5%~90%, non-condensing
Safety	CE, FCC
Weight	7 kg
Physical Dimensions	430 mm x 426 mm x 44.2 mm (W x D x H)
Operating System	Linux Ubuntu 18.04.04 / CentOS 7 / Red Hat / Fedora EPEL / Microsoft Windows 10

Table 1-2: Technical Specifications

PUZZLE-IN001

1.6.1 Expansion Slot Block Diagram

The block diagram of the expansion slots is shown below:

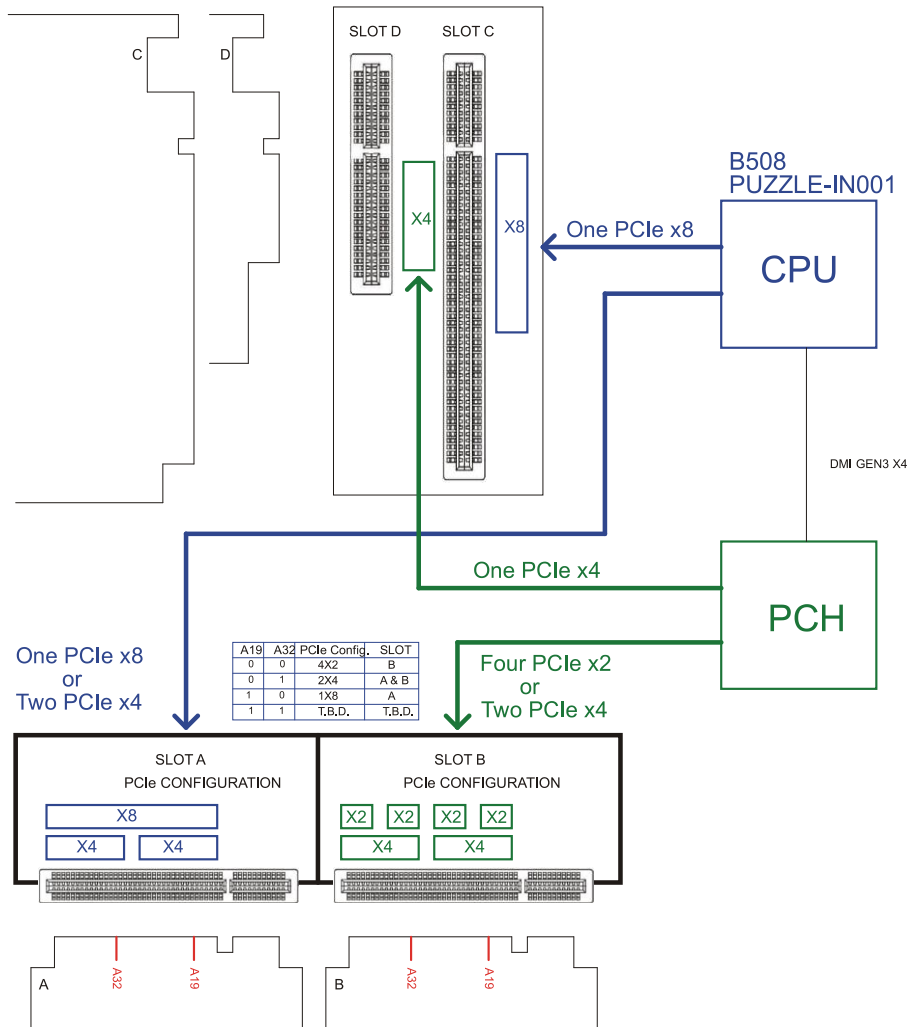

Figure 1-4: Expansion Slot Block Diagram

1.7 Dimensions

The physical dimensions are shown below:

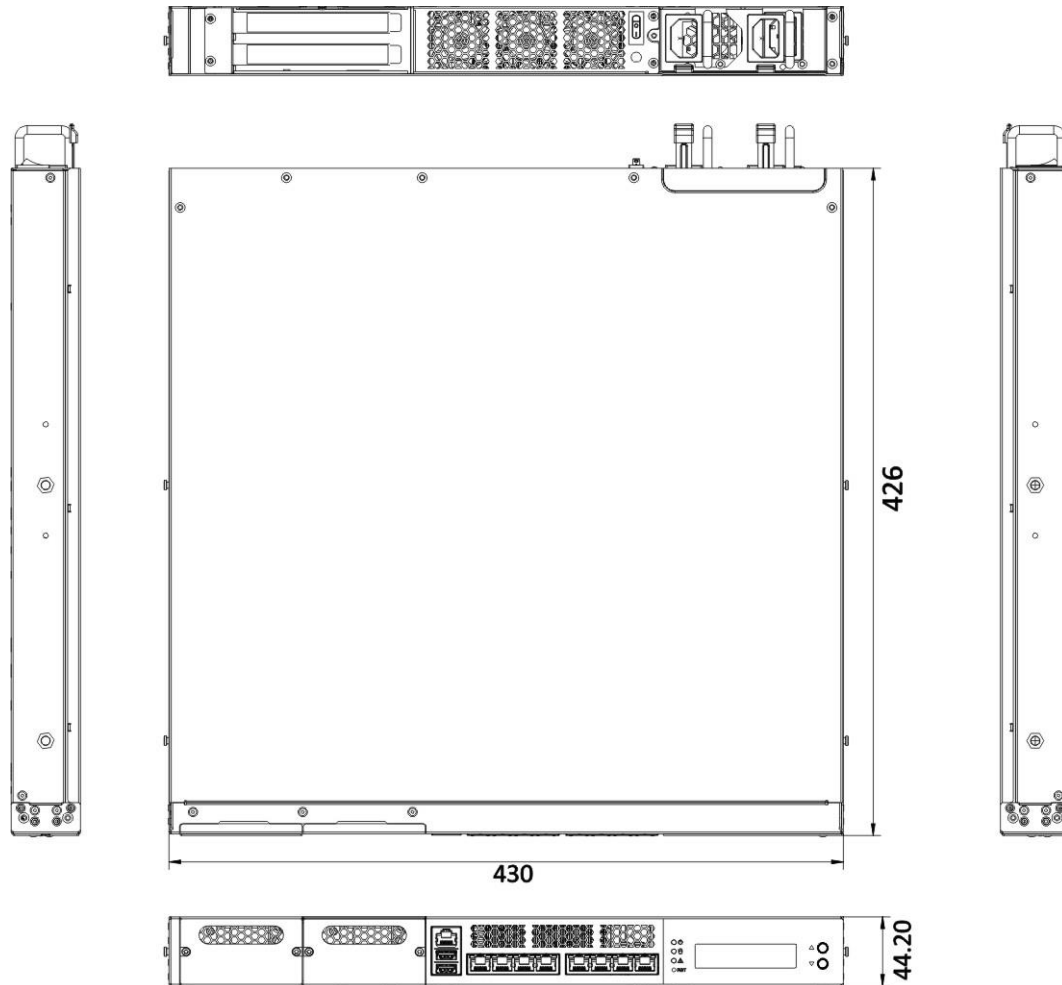

Figure 1-5: Physical Dimensions (millimeters)

Chapter

2

Unpacking

2.1 Anti-static Precautions



WARNING:

Failure to take ESD precautions during installation may result in permanent damage to the PUZZLE-IN001 and severe injury to the user.

Electrostatic discharge (ESD) can cause serious damage to electronic components, including the PUZZLE-IN001. Dry climates are especially susceptible to ESD. It is therefore critical that whenever the PUZZLE-IN001 or any other electrical component is handled, the following anti-static precautions are strictly adhered to.

- **Wear an anti-static wristband:** Wearing a simple anti-static wristband can help to prevent ESD from damaging the board.
- **Self-grounding:** Before handling the board, touch any grounded conducting material. During the time the board is handled, frequently touch any conducting materials that are connected to the ground.
- **Use an anti-static pad:** When configuring the PUZZLE-IN001, place it on an anti-static pad. This reduces the possibility of ESD damaging the PUZZLE-IN001.

2.2 Unpacking Precautions

When the PUZZLE-IN001 is unpacked, please do the following:

- Follow the anti-static precautions outlined in **Section 2.1**.
- Make sure the packing box is facing upwards so the PUZZLE-IN001 does not fall out of the box.
- Make sure all the components shown in **Section 2.3** are present.

PUZZLE-IN001



2.3 Packing List



NOTE:

If some of the components listed in the checklist below are missing, please do not proceed with the installation. Contact the IEI reseller or vendor you purchased the PUZZLE-IN001 from or contact an IEI sales representative directly. To contact an IEI sales representative, please send an email to sales@ieiworld.com.

The PUZZLE-IN001 is shipped with the following components:

Quantity	Item	Image
1	PUZZLE-IN001	
2	Power cord	
2	Rack mount brackets <i>(Note: The brackets must be used with sliding rails.)</i>	
6	Mounting bracket screw (M4*6)	
1	USB to console cable <i>(only for SKUs with memory)</i>	
1	RS-232 to console cable <i>(only for SKUs without memory)</i>	

2.4 Optional Items

The following table lists the optional items that can be purchased separately.

Optional Item	Image
Sliding rails for rack mount (P/N: RAIL-B02)	
USB to console cable (P/N: 32013-004000-100-RS)	
RS-232 to console cable (P/N: 32005-005100-100-RS)	
20-pin Infineon TPM 2.0 module, software management tool, firmware v5.5 (P/N: TPM-IN02-R20)	
CPU heatsink (80W) (P/N: 34000-000722-RS)	
CPU heatsink (35W) (P/N: 34000-000731-RS)	

Chapter

3

Installation

3.1 Installation Precautions



CAUTION!

The PUZZLE-IN001 series has more than one power supply connection point.

To reduce the risk of electric shock, disconnect all power sources before installing or servicing the PUZZLE-IN001 series.

During installation, be aware of the precautions below:

- **Read the user manual:** The user manual provides a complete description of the PUZZLE-IN001, installation instructions and configuration options.
- **DANGER! Disconnect Power:** Power to the PUZZLE-IN001 must be disconnected during the installation process. Failing to disconnect the power may cause severe injury to the body and/or damage to the system.
- **Qualified Personnel:** The PUZZLE-IN001 must be installed and operated only by trained and qualified personnel. Maintenance, upgrades, or repairs may only be carried out by qualified personnel who are familiar with the associated dangers.
- **Air Circulation:** Make sure there is sufficient air circulation when installing the PUZZLE-IN001. The PUZZLE-IN001's cooling vents must not be obstructed by any objects. Blocking the vents can cause overheating of the PUZZLE-IN001. Leave at least 5 cm of clearance around the PUZZLE-IN001 to prevent overheating.
- **Grounding:** The PUZZLE-IN001 should be properly grounded. The voltage feeds must not be overloaded. Adjust the cabling and provide external overcharge protection per the electrical values indicated on the label attached to the back of the PUZZLE-IN001.

PUZZLE-IN001

3.2 Top Cover Removal

**WARNING:**

Never open the equipment. For safety reasons, the equipment should be opened only by qualified skilled person.

Before installing or maintaining the internal components, the top cover must be removed from the PUZZLE-IN001. Follow the steps below to complete the task.

Step 1: Remove the five retention screws indicated in **Figure 3-1**.

Step 2: Slide the top cover towards the rear side and gently lift the top cover (**Figure 3-1**).



Figure 3-1: Top Cover Removal

3.3 DIMM Installation



CAUTION:

For dual channel configuration, always install two identical memory modules that feature the same capacity, timings, voltage, number of ranks and the same brand.

To install the DIMM module, please follow the steps below.

Step 1: Remove the top cover from the PUZZLE-IN001. Please follow the instruction described in **Section 3.2**.

Step 2: Locate the DIMM slots on the motherboard.

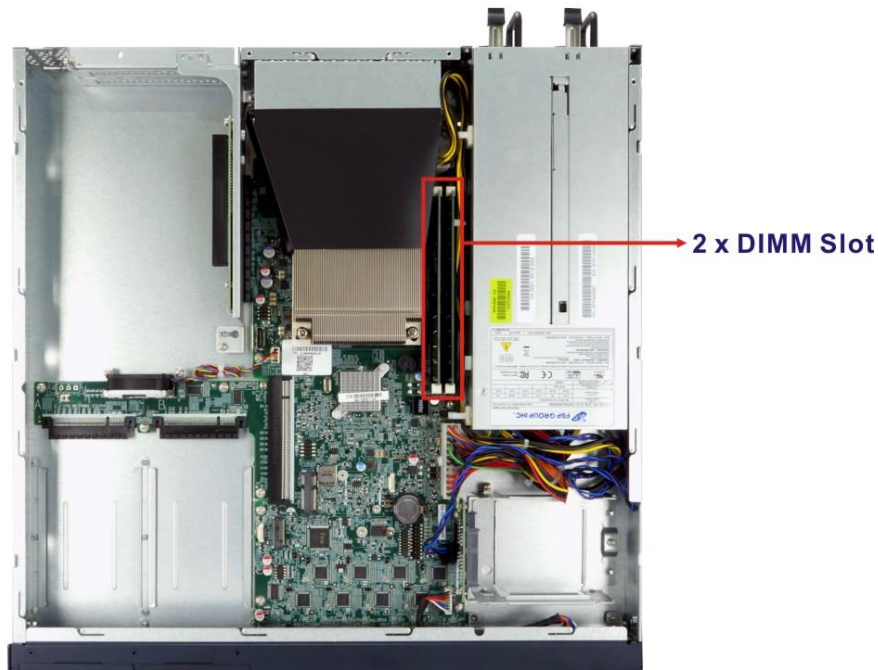

Figure 3-2: DIMM Slot Locations

Step 3: Open the DIMM socket handles. Open the two handles outwards as far as they can.

PUZZLE-IN001

Step 4: Align the DIMM so the notch on the memory lines up with the notch on the memory socket.

Step 5: Once aligned, press down until the DIMM is properly seated. Clip the two handles into place.

To remove a DIMM, push both handles outward. The memory module is ejected by a mechanism in the socket.

3.4 CPU Installation (PUZZLE-IN001-R Only)



WARNING:

CPUs are expensive and sensitive components. When installing the CPU please be careful not to damage it in anyway. Make sure the CPU is installed properly and ensure the correct cooling kit is properly installed.

DO NOT touch the pins at the bottom of the CPU. When handling the CPU, only hold it on the sides.

To install the CPU, follow the steps below.

Step 1: **Disengage the load lever** by pressing the lever down and slightly outward to clear the retention tab. Fully open the lever. See **Figure 3-3**.

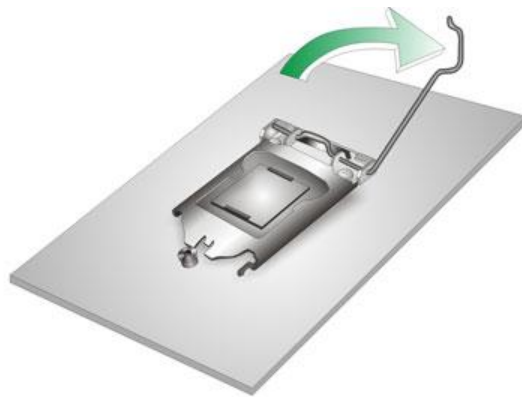

Figure 3-3: Disengage the CPU Socket Load Lever

Step 2: Open the socket and remove the protective cover. The black protective cover can be removed by pulling up on the tab labeled "Remove". See

Figure 3-4.

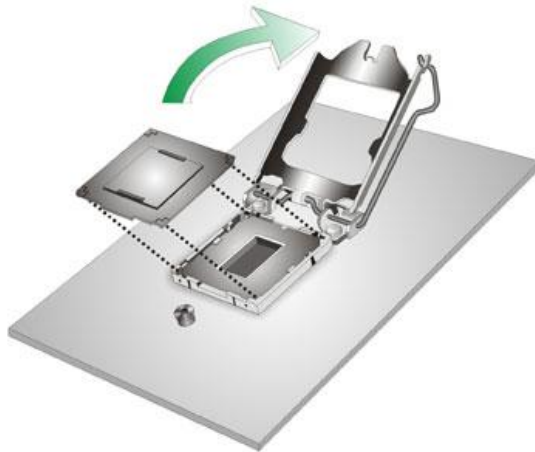

Figure 3-4: Remove Protective Cover

Step 3: **Inspect the CPU socket.** Make sure there are no bent pins and make sure the socket contacts are free of foreign material. If any debris is found, remove it with compressed air.

Step 4: **Orientate the CPU properly.** The contact array should be facing the CPU socket.

Step 5: **Correctly position the CPU.** Match the Pin 1 mark with the cut edge on the CPU socket.

Step 6: **Align the CPU pins.** Locate pin 1 and the two orientation notches on the CPU. Carefully match the two orientation notches on the CPU with the socket alignment keys.

Step 7: **Insert the CPU.** Gently insert the CPU into the socket. If the CPU pins are properly aligned, the CPU should slide into the CPU socket smoothly. See

Figure 3-5.

PUZZLE-IN001

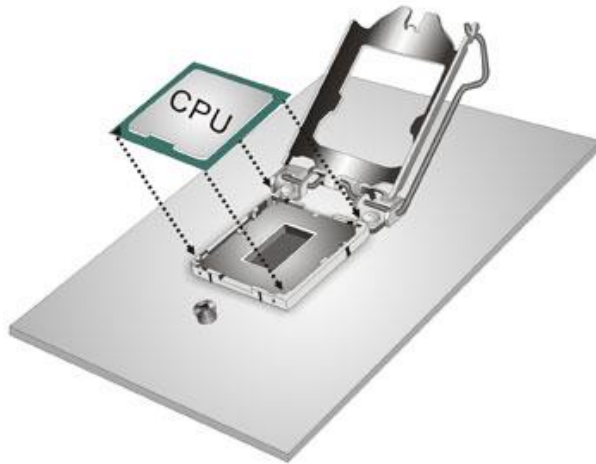

Figure 3-5: Insert the Socket LGA1155 CPU

Step 8: Close the CPU socket. Close the load plate and pull the load lever back a little to have the load plate be able to secure to the knob. Engage the load lever by pushing it back to its original position (**Figure 3-6**). There will be some resistance, but will not require extreme pressure.

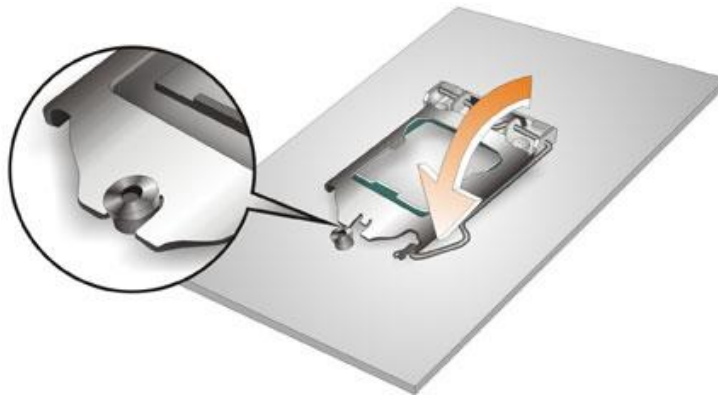

Figure 3-6: Close the Socket LGA1155

3.4.1 CPU Heatsink Installation (PUZZLE-IN001-R Only)

**WARNING:**

Do not wipe off (accidentally or otherwise) the pre-sprayed layer of thermal paste on the bottom of the heat sink. The thermal paste between the CPU and the heat sink is important for optimum heat dissipation.

A CPU heatsink must be installed in the PUZZLE-IN001-R after the CPU installation. The CPU heatsink can be bought from IEI. To install the heatsink, follow the instructions below.

- Step 1:** A heatsink bracket is pre-installed on the rear of the motherboard
- Step 2: Properly orient the CPU heatsink.** The CPU heatsink must be oriented as shown in **Figure 3-7** so that thermal convection currents can carry the heat away from the heatsink.
- Step 3: Place the CPU heatsink onto the CPU.** Push down the heatsink with some pressure to secure the heatsink with the support bracket.
- Step 4: Tighten the screws.** Use a screwdriver to tighten the four screws. In a diagonal pattern, tighten each screw a few turns then move to the next one, until they are all secured. Do not overtighten the screws.
- Step 5: Install the hood.** Peel off the backing of the double-sided tapes attached inside the hood. Attach the hood to the chassis and the heatsink as shown in **Figure 3-7**.

PUZZLE-IN001

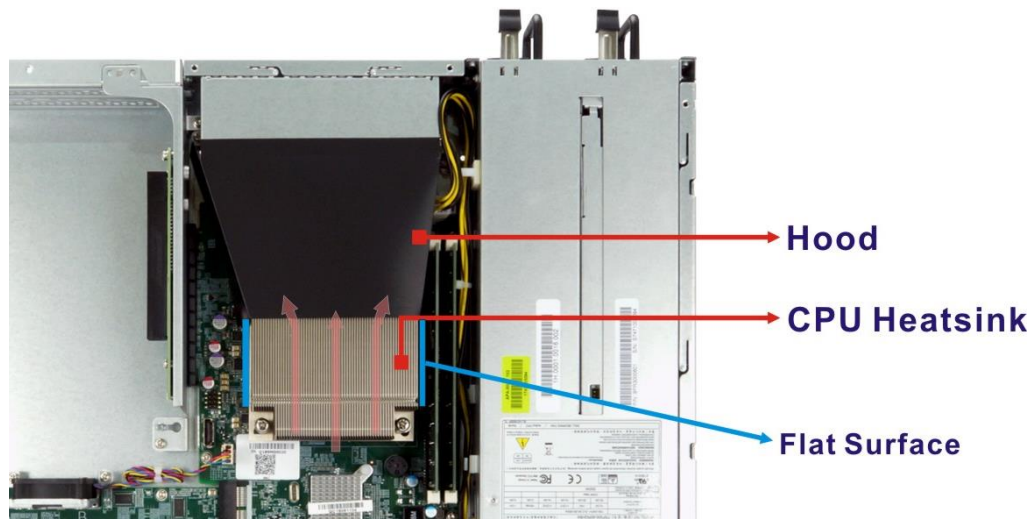

Figure 3-7: CPU Heatsink Installation

3.5 HDD Installation

The PUZZLE-IN001 allows installation of two 2.5" SATA HDD/SSD. To install HDDs into the system, please follow the steps below.

- Step 1:** Remove the top cover from the PUZZLE-IN001. Please follow the instruction described in **Section 3.2**.
- Step 2:** Remove the HDD bracket from the system. To do this, remove the three retention screws indicated below and disconnect the SATA connector module from the motherboard.

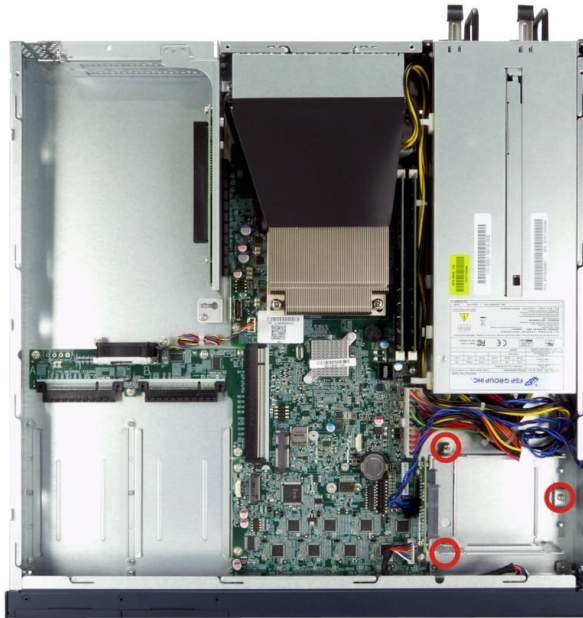

Figure 3-8: HDD Bracket Retention Screws

Step 3: Insert an HDD into the bracket until the HDD is properly connected to the SATA connector. Secure the HDD with four retention screws (M3*4). See **Figure 3-10**.



Figure 3-9: Secure HDD to the Bracket

Step 4: Re-connect the SATA connector module to the motherboard. Make sure the two positioning studs on the chassis go through the two small holes on the HDD

PUZZLE-IN001

bracket (**Figure 3-10**). Secure the bracket to the chassis with three screws removed previously.



Figure 3-10: HDD Installation

Step 5: Re-install and secure the top cover to the system.

3.6 PCIe Expansion Card Installation

The PUZZLE-IN001 allows installation of one PCIe x4 card and one PCIe x8 card. To install a PCIe expansion card, please follow the steps below.

Step 1: Remove the top cover from the PUZZLE-IN001 (refer to **Section 3.2**).

Step 2: Remove the four expansion slot module retention screws indicated below.

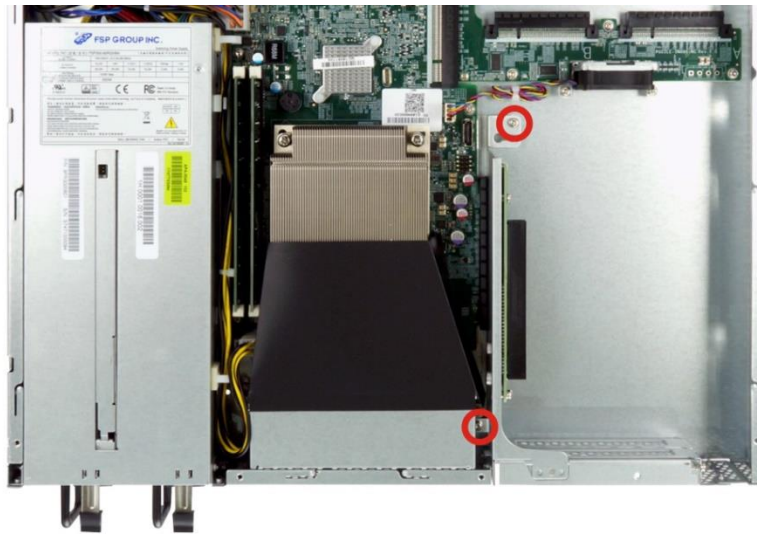

Figure 3-11: Expansion Slot Module Retention Screws

Step 3: Push the expansion slot module with strength to disconnect the module from the edge connector of the motherboard.

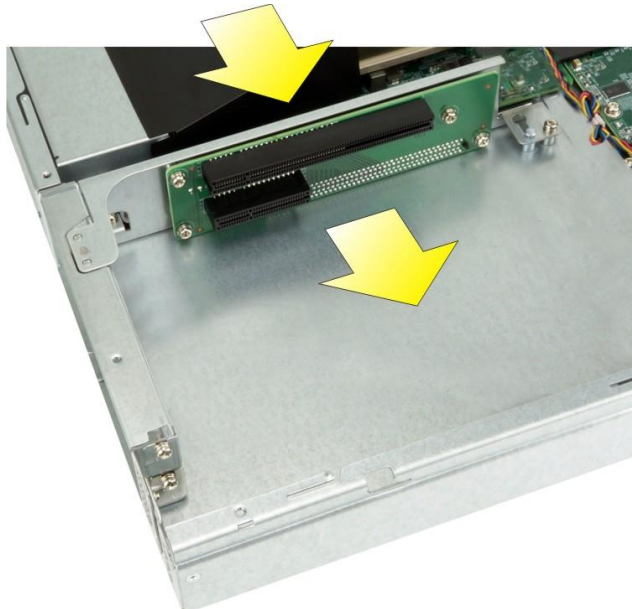

Figure 3-12: Disconnect the Expansion Slot Module

PUZZLE-IN001

Step 4: Remove the blank bracket panel that aligns with the PCIe slot for installing the expansion card. Save the bracket screw.



Figure 3-13: Blank Bracket Screw

Step 5: Align the expansion card to the PCIe slot. Press gently, but firmly, to seat the expansion card correctly in the slot. Install the bracket screw to secure the card to the expansion slot module.



Figure 3-14: PCIe Expansion Card Installation

Step 6: Place the expansion slot module back to the original position by hooking the slotted hole into the positioning stud in the chassis (**Figure 3-15 A**). Push the connector of the expansion slot module into the edge connector to install it.

During installation, ensure that

1. the connector on the slot module is properly aligned and connected to the edge connector;
2. the two studs on the side is going through the two holes in the chassis;
3. the slot module tab is going under the chassis tab.

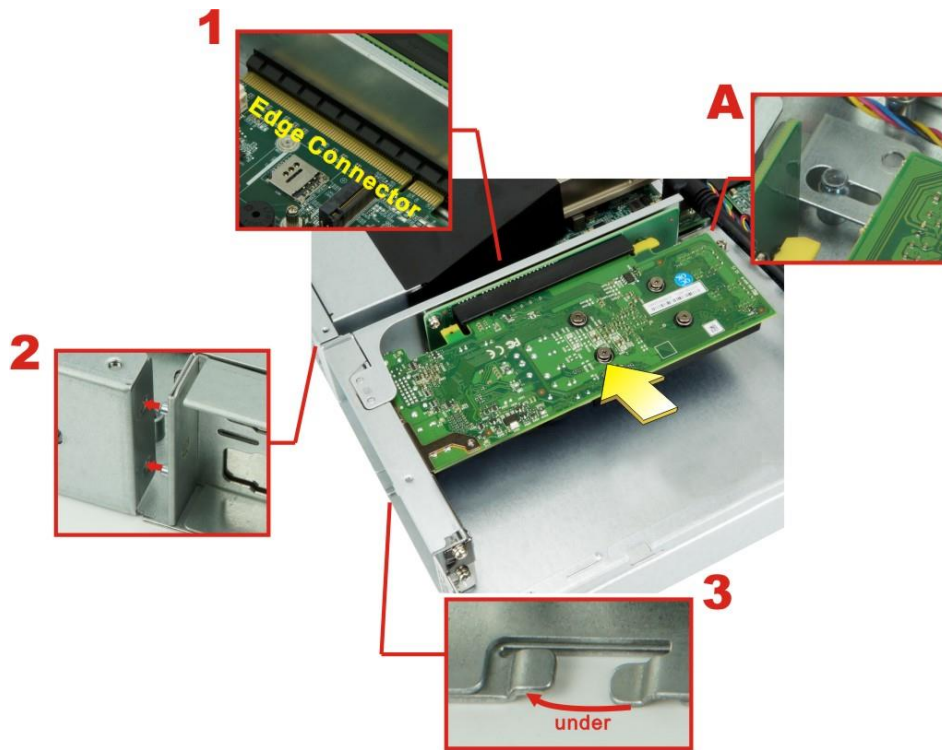

Figure 3-15: Expansion Slot Module Installation

Step 7: Secure the expansion slot module with the four retention screws previously removed.

PUZZLE-IN001

3.7 IEI Networking Module Installation

The PUZZLE-IN001 allows installation of two IEI PulM networking modules. To install a networking module, please follow the steps below.

- Step 1:** Disconnect all power sources from the system. **NOTE:** To install or replace the networking module, the power supply must be fully disconnected before installation.
- Step 2:** Remove the two Torx (star) screws indicated below to remove the slot cover. Save the slot cover screws. The Slot A supports 8 lanes from CPU (1 PCIe x8 or 2 PCIe x4); the Slot B supports 8 lanes from PCH (2 PCIe x4 or 4 PCIe x2). For pinouts of the Slot A/B, refer to **Section 5.2.18** and **Section 5.2.19**.



Figure 3-16: Networking Module Slot Cover Screws

- Step 3:** Slide an IEI networking module into the slot until the module is seated in the slot correctly and securely. Install the previously-removed Torx screws to secure the module to the chassis.

**CAUTION:**

When inserting the module, the bottom of the networking module must be as close to the system base as possible so that the module can be slid into the guide rails.

When removing the module, slide the module horizontally all the way until it is completely out of the system. Lifting up the module before completely sliding out may cause the components on the module to be damaged by the chassis structure.



Figure 3-17: Networking Module Installation

Step 4: Re-install the top cover.

3.7.1 Bypass Configuration in BIOS

Some PulM modules support bypass. To enable/disable bypass function, configure the BIOS menu of the PUZZLE-IN001 as described below.

Step 1: Go to **Chipset** → **PCH - IO Configuration** → **NETWORK Configuration (Bypass Setting)**.

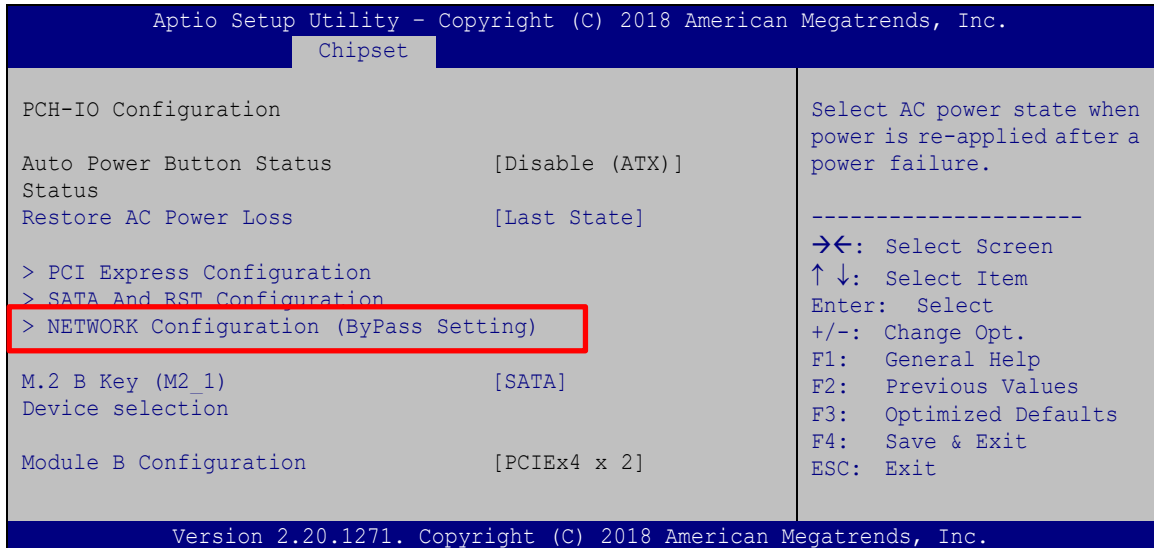

PUZZLE-IN001

Step 2: The **Network ByPass Setting** menu appears. The model names of the PulM module installed in the PUZZLE-IN001 are shown.

```

Aptio Setup Utility - Copyright (C) 2018 American Megatrends, Inc.
Chipset
Network ByPass setting
Slot_A Model Name          PulM-10G4SF-XL710
Power_ON ByPass Mode       [Disabled]
Power_OFF ByPass Mode      [Enabled]
Slot_B Model Name          PulM-1G4T-I211-BP
Power_ON ByPass Mode       [Disabled]
Power_OFF ByPass Mode      [Enabled]
Switch all ByPass Mode to
Enable/Disable after power
on.
-----
-><: Select Screen
↑↓: Select Item
Enter: Select
+/-: Change Opt.
F1: General Help
F2: Previous Values
F3: Optimized Defaults
F4: Save & Exit
ESC: Exit
Version 2.20.1271. Copyright (C) 2018 American Megatrends, Inc.
  
```

Step 3: Configure the **Power_ON ByPass Mode** and the **Power_OFF ByPass Mode** BIOS options to enable/disable bypass function of the installed PulM modules.

PUZZLE BIOS Setting	Power_ON ByPass Mode		Power_OFF ByPass Mode	
	Disabled	Enabled	Disabled	Enabled
PulM Bypass Function	Disable bypass when system on	Enable bypass when system on	Disable bypass when system off	Enable bypass when system off

Step 4: Press **F4** to save and exit the BIOS menu. The PUZZLE-IN001 will reboot with the new settings.

3.8 M.2 Module Installation

**NOTE:**

The M.2 B-key slot is configured as SATA device by default. To change the M.2 slot to PCIe device, go to **Chipset → PCH-IO Configuration** BIOS menu and configure the **M.2 B Key (M2_1) device selection** BIOS option (see Section 4.4.2).

The M.2 slot is keyed in the B position and provides mounting screw position for 2260-size/3042-size M.2 module. To install an M.2 module, please follow the steps below.

Step 1: Remove the top cover from the PUZZLE-IN001. See **Section 3.2**.

Step 2: Locate the M.2 slot on the motherboard.

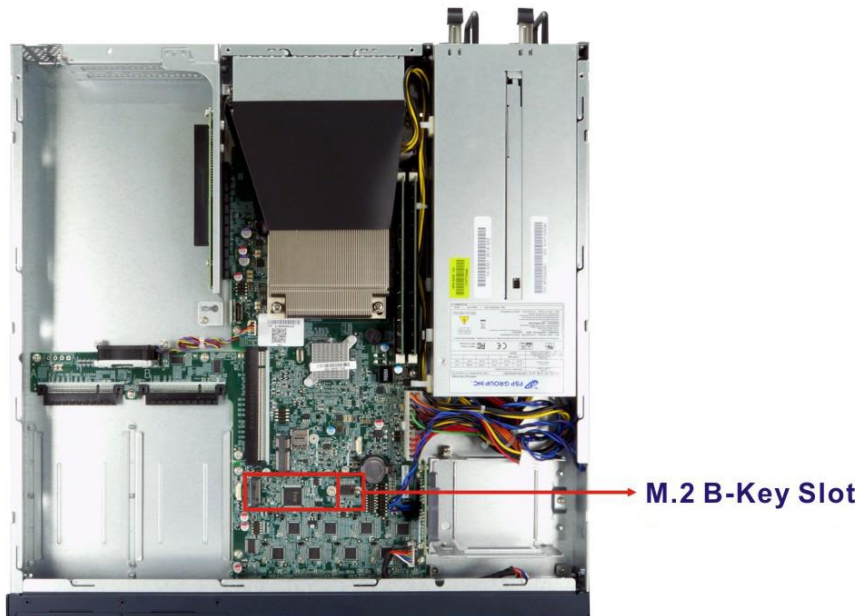

Step 3: Remove the on-board retention screw. **NOTE:** For 2260-size module installation, the screw and the standoff for the 3042 module must also be removed to avoid interference.

PUZZLE-IN001

Step 4: Line up the notch on the module with the notch on the slot. Slide the M.2 module into the socket at an angle of about 20°.

Step 5: Push the M.2 module down and secure it with the previously removed retention screw.

3.9 PCIe Mini Card Installation

The PUZZLE-IN001 has one full-size/half-size PCIe Mini slot on the motherboard. To install a full-size module, follow the instructions below.

Step 1: Remove the top cover from the PUZZLE-IN001. See **Section 3.2**.

Step 2: Locate the PCIe Mini slot on the motherboard (Figure 3-18).

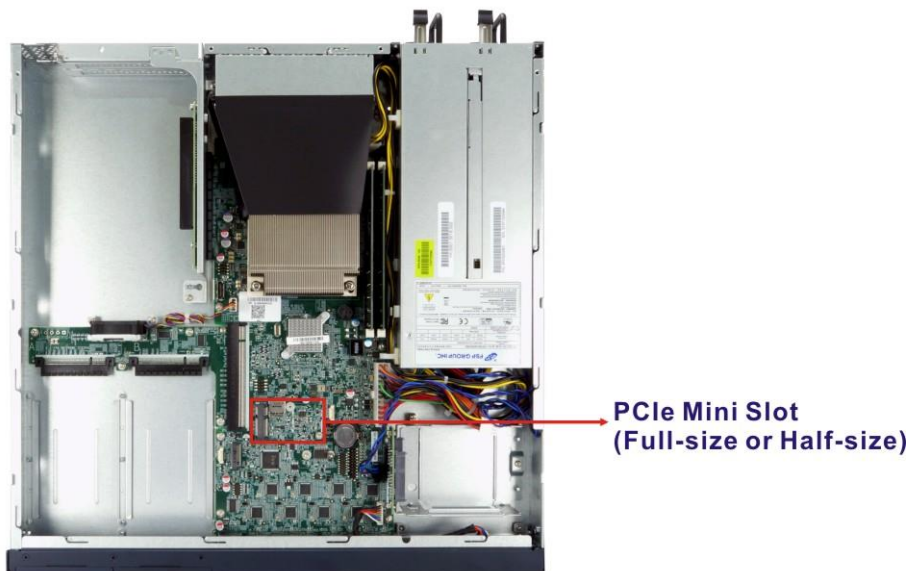

Figure 3-18: PCIe Mini Slot Location

Step 3: Remove the pre-installed retention screw from the standoff.

Step 4: Line up the notch on the card with the notch on the slot. Slide the PCIe Mini card into the socket at an angle of about 20°.

Step 5: Secure the full-size PCIe Mini card with the retention screw previously removed.

3.9.1 Half-size PCIe Mini Card Installation

The PCIe Mini slot also allows installation of a half-size PCIe Mini card. To install a half-size PCIe Mini card, please follow the steps below.

- Step 1:** Remove the pre-installed retention screw and the standoff from the motherboard.
- Step 2:** Install the previously removed standoff to the screw hole for the half-size PCIe Mini card.
- Step 3:** Line up the notch on the card with the notch on the slot. Slide the PCIe Mini card into the socket at an angle of about 20°.
- Step 4:** Secure the half-size PCIe Mini card with the retention screw previously removed.

3.10 LAN Connection

The LAN connectors on the front panel allow connection to an external network. The pinouts of the LAN connectors are listed below.

Pin	Description	Pin	Description
1	TRD0+	5	TRD2-
2	TRD0-	6	TRD1-
3	TRD1+	7	TRD3+
4	TRD2+	8	TRD3-

Table 3-1: LAN Pinouts

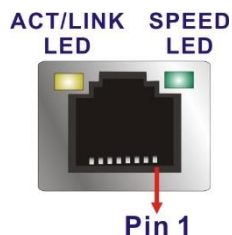

Figure 3-19: RJ-45 Ethernet Connector

PUZZLE-IN001

The RJ-45 Ethernet connector has two status LEDs, one yellow and one green/orange. The yellow LED indicates activity on the port and the green/orange LED indicates the speed. See **Table 3-2**.

Activity/Link LED		Speed LED	
STATUS	DESCRIPTION	STATUS	DESCRIPTION
Off	No link	Off	10 Mbps connection
Yellow	Linked	Green	100 Mbps connection
Blinking	TX/RX activity	Orange	1 Gbps connection

Table 3-2: RJ-45 Ethernet Connector LEDs

3.11 Console Connection

The PUZZLE-IN001 has one RJ-45 serial device connector on the front panel. The RJ-45 connector for the serial port can be identified easily as the RJ-45 for the network has two LEDs on the port, while the connectors for the serial cables don't. The pinouts of the serial port are listed below.

Pin	Description	Pin	Description
1	-NRTS1	5	GND
2	-NDTR1	6	NSIN1
3	NSOUT1	7	-NDSR1
4	GND	8	-NCTS1

Table 3-3: RJ-45 Serial Port Pinouts

The console port (RJ-45) connects to a cable with a standard D-sub 9 connector or a USB connector (varied from SKU) at the other end.

3.11.1 Enable Console Port When Booting

To configure the PUZZLE-IN001 to make it auto enable the console port when booting, follow the steps below.



NOTE:

This method only works in Linux Ubuntu, the default operating system.

- Step 1:** Use the console cable shipped with the product to connect the RJ-45 console port of the PUZZLE-IN001 with your PC.
- Step 2:** In your PC, go to Windows **Device Manager** and check for the serial line of the connected USB serial port. In this case, it is COM3.

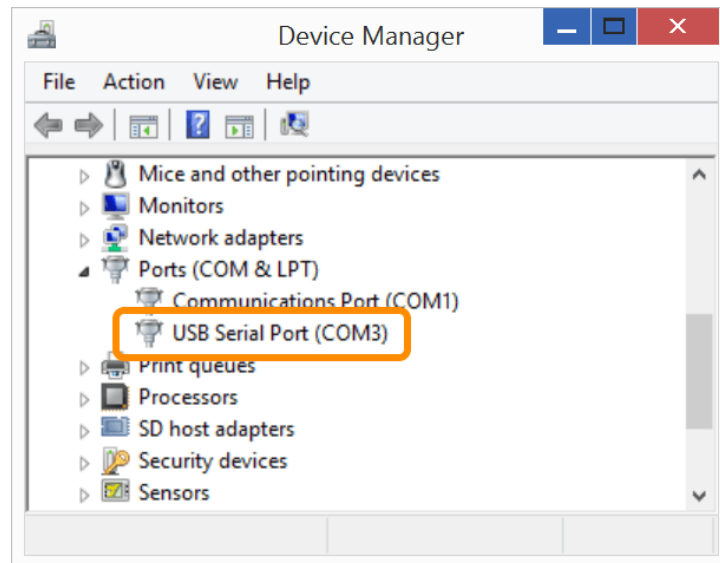

- Step 3:** Open a serial console application, PuTTY, as an example.
- Step 4:** Set the speed of the serial connection to “115200”, and choose “Serial” for Connection Type.
- Step 5:** Click “Open” on PuTTY.

PUZZLE-IN001

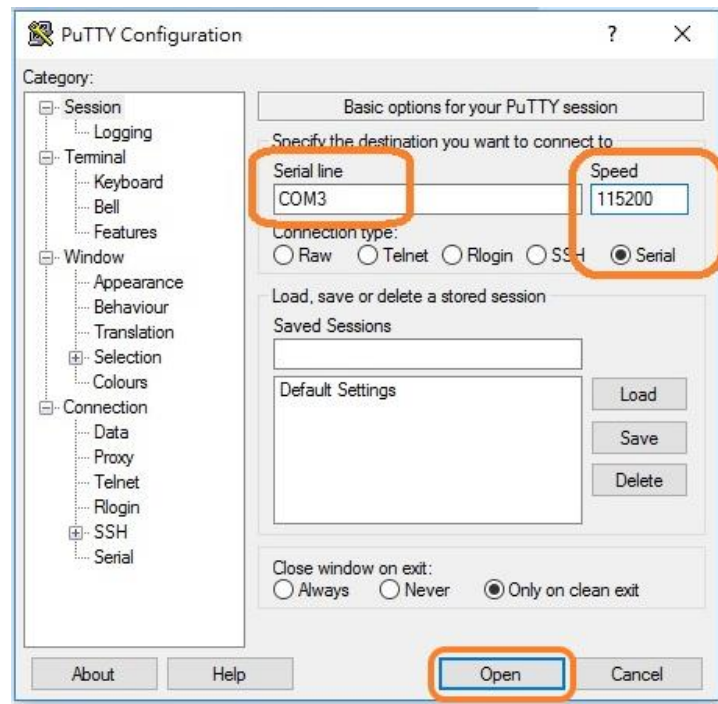

Step 6: Enter the following command:

```
sudo vi /lib/systemd/system/ttyS0.service
```

Step 7: Ensure the information shown match the followings:

[Unit]

Description=Serial Console Service

[Service]

ExecStart=/sbin/getty -L 115200 ttyS0 vt102

Restart=always

[Install]

WantedBy=multi-user.target

Step 8: Run the following commands one by one:

```
sudo systemctl daemon-reload
```

```
sudo systemctl enable ttyS0
```

```
sudo systemctl start ttyS0
```

3.12 Rack Mount

The PUZZLE-IN001 is shipped with two rack mount brackets that could be used to secure the system to the rack after mounting it with the optional sliding rails. To install the PUZZLE-IN001 into a rack, please follow the steps below.



WARNING:

The provided rack mount brackets must be used with sliding rails. Using only the rack mount brackets to mount the system on a rack may cause damage to the system.

- Step 1:** Install the rack mount brackets to the sides of the PUZZLE-IN001 by inserting three retention screws (M4*6) into each bracket (**Figure 3-20**). Make sure the screws are tight and on the right positions.

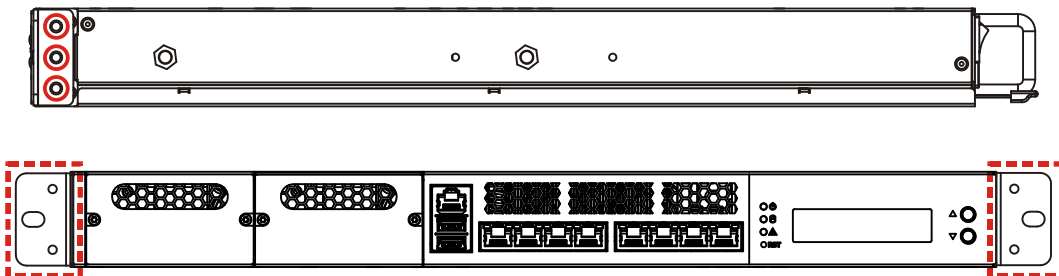

Figure 3-20: Rack Mount Bracket Installation

- Step 2:** Install the sliding rails according to the instruction came with the sliding rails.
Note: The sliding rails must be purchased separately.
- Step 3:** Slide the PUZZLE-IN001 all the way into the rack enclosure.
- Step 4:** Secure the front of the rack mount brackets that are attached to the sides of the PUZZLE-IN001 to the front of the rack.

PUZZLE-IN001

3.13 Power-On Procedure

**WARNING:**

1. Make sure a power supply with the correct input voltage is being fed into the system. Incorrect voltages applied to the system may cause damage to the internal electronic components and may also cause injury to the user.
 2. Ensure to connect the power cord to a socket-outlet with earthing connection.
-

To power-on the PUZZLE-IN001 please follow the steps below:

Step 1: Connect the power source to the power inlets on the rear panel.

Ensure to connect the power cord to a socket-outlet with earthing connection.

Step 2: Turn on the power switch to power up the system.

Step 3: The power LED indicator on the front panel turns to green.

Step 4: Use the following information when prompted for the username and password for login to the system.

Username: puzzle

Password: admin

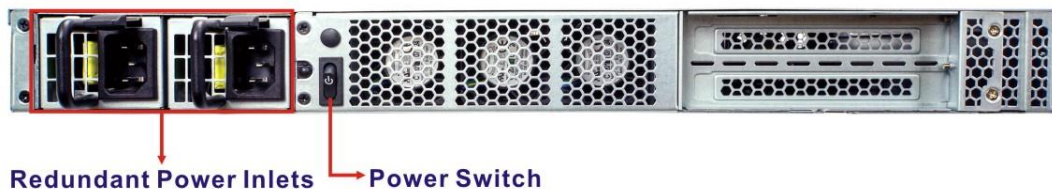

Figure 3-21: Power-on

3.14 Available Drivers

All the drivers for the PUZZLE-IN001 are available on IEI Resource Download Center (<https://download.ieiworld.com>). Type PUZZLE-IN001 and press Enter to find all the relevant software, utilities, and documentation.

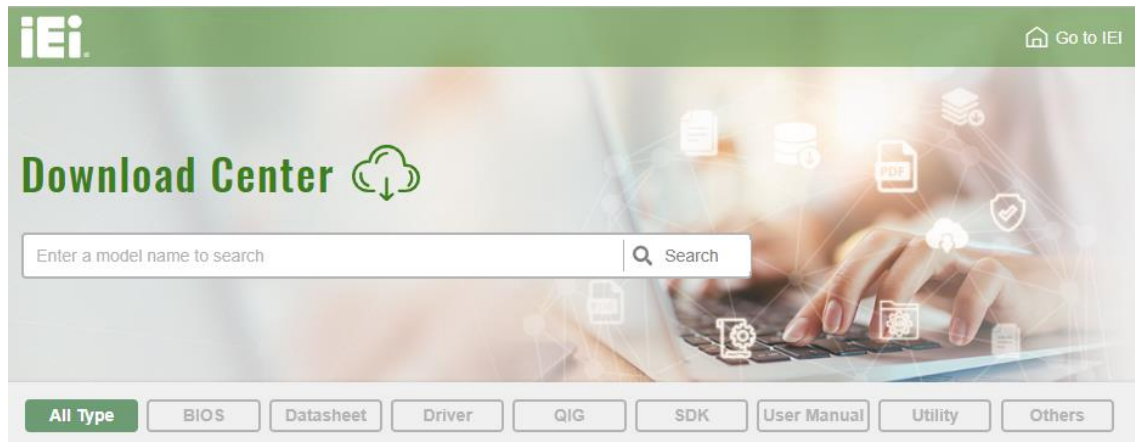

Figure 3-22: IEI Resource Download Center



NOTE:

To install software from the downloaded ISO image file in Windows 10, double-click the ISO file to mount it as a virtual drive to view its content.

PUZZLE-IN001

3.14.1 Driver Download

To download drivers from IEI Resource Download Center, follow the steps below.

Step 1: Go to <https://download.ieiworld.com>. Type PUZZLE-IN001 and press Enter.

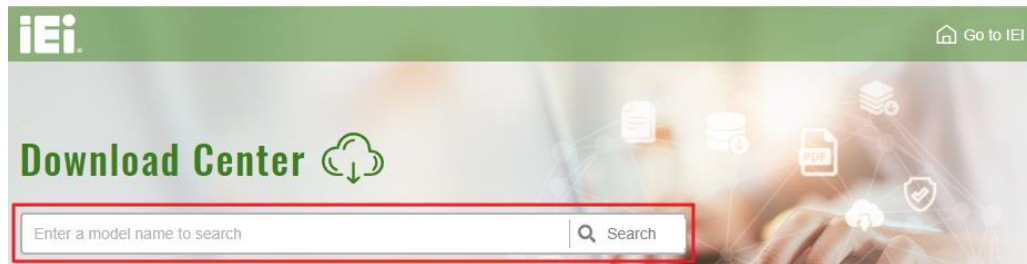

Step 2: All product-related software, utilities, and documentation will be listed. You can choose **Driver** to filter the result.

Keyword: "PUZZLE-IN001", Searching Result : 8 Records.

PUZZLE-IN001 Product Info ▶

Networking & Data Storage ▶ Networking ▶ x86 Rackmount Network Appliances

1U Rackmount Network Appliance with Intel® Xeon® E, 8th Generation Intel® Core™/Pentium®/Celeron® Processor, up to 2 NMS and 2 PCIe slots

Driver

File Name	Published	Version	File Checksum
PUZZLE-IN001_V1.0.iso (1.4 GB)	2019/01/08	1.00	034F39D144AA6C6A3F0198238CA063A4

Step 3: Click the driver file name on the page and you will be prompted with the following window. You can download the entire ISO file (❶), or double click an individual item to find its driver file and click the file name to download (❷).

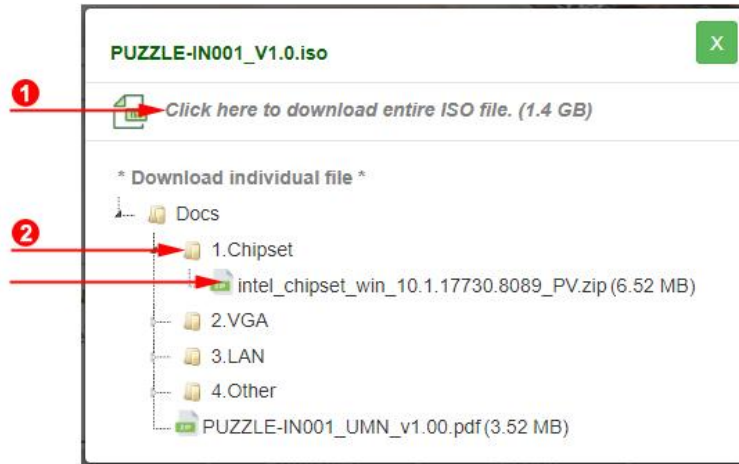

3.15 Maintenance



WARNING:

The following instructions should only be performed by an authorized and trained technician.

Before starting, please ensure that you turn off the PUZZLE-IN001, disconnect the power cords, network cable(s), and also remove any other device/cable that is attached to the server.

Take Anti-Static precautions whenever maintenance is being carried out on the system components. Failure to take anti-static precautions can cause permanent system damage. For more details on anti-static precautions, please refer to **Section 2.1**.

PUZZLE-IN001

3.15.1 Power Supply Unit Replacement

The two power supply units (PSU) of the PUZZLE-IN001 series are hot-swappable, which means users can replace the PSU when the system is up and running. To replace a failed power supply unit, please follow the steps below.

Step 1: Firmly press and hold the black button on back of PSU downwards. Pull out power supply by pulling the black handle.

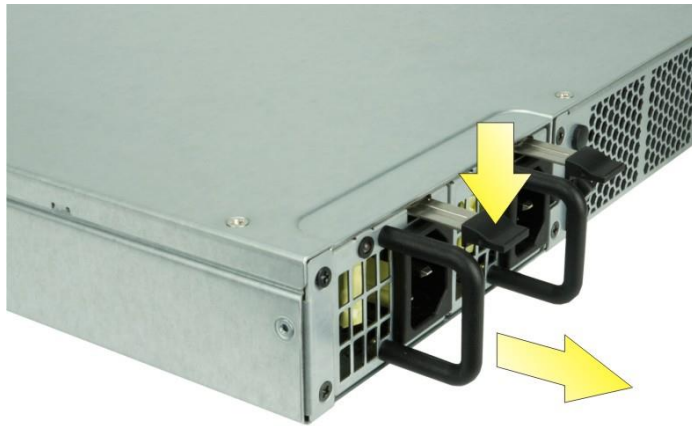

Step 2: Insert new power supply into the PUZZLE-IN001.

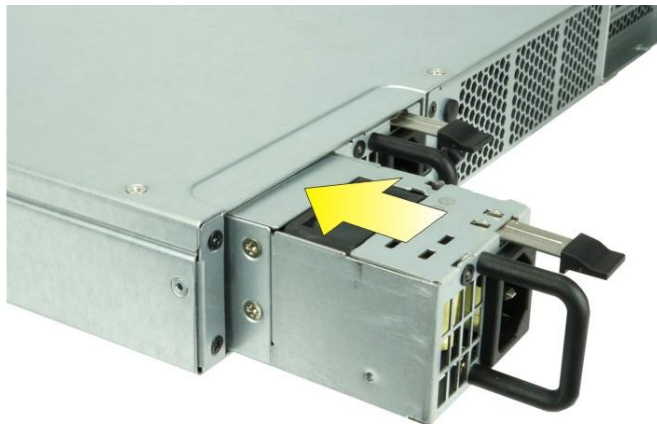

Step 3: Connect the power cord to the PUZZLE-IN001.

Step 4: Power on the system.

3.15.2 Jumper Settings

To configure the jumper settings, please follow the steps below.

Step 1: Remove the top cover. See **Section 3.2**.

Step 2: Locate the jumper/button on the embedded motherboard.

Step 3: Make the jumper settings in accordance with the settings described and defined in the following sections.

3.15.2.1 Clear CMOS

If the PUZZLE-IN001 fails to boot due to improper BIOS settings, the clear CMOS button clears the CMOS data and resets the system BIOS information. To do this, push the clear CMOS button for a few seconds.

If the “CMOS Settings Wrong” message is displayed during the boot up process, the fault may be corrected by pressing the F1 to enter the CMOS Setup menu. Do one of the following:

- Enter the correct CMOS setting
- Load Optimal Defaults
- Load Failsafe Defaults.

After having done one of the above, save the changes and exit the CMOS Setup menu.

The clear CMOS button location is shown in **Figure 3-23** below.

PUZZLE-IN001

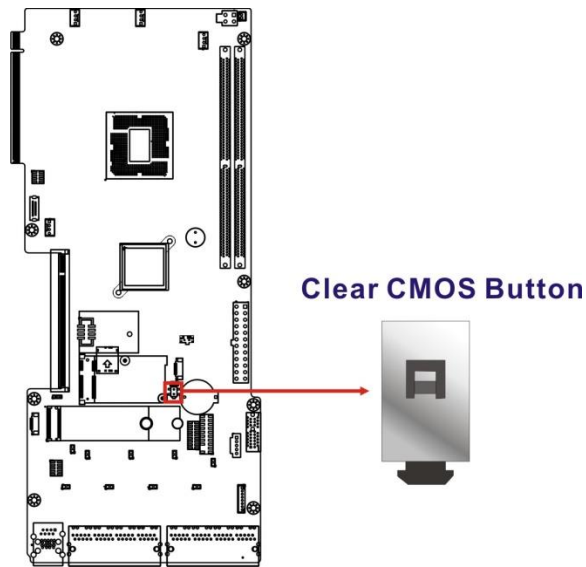

Figure 3-23: Clear CMOS Button Location

3.15.2.2 Flash Descriptor Security Override Jumper

The Flash Descriptor Security Override jumper (J_FLASH1) allows users to enable or disable the ME firmware update. Refer to **Figure 3-24** and **Table 3-4** for the jumper location and settings.

Setting	Description
Short 1-2	Disabled (default)
Short 2-3	Enabled

Table 3-4: Flash Descriptor Security Override Jumper Settings

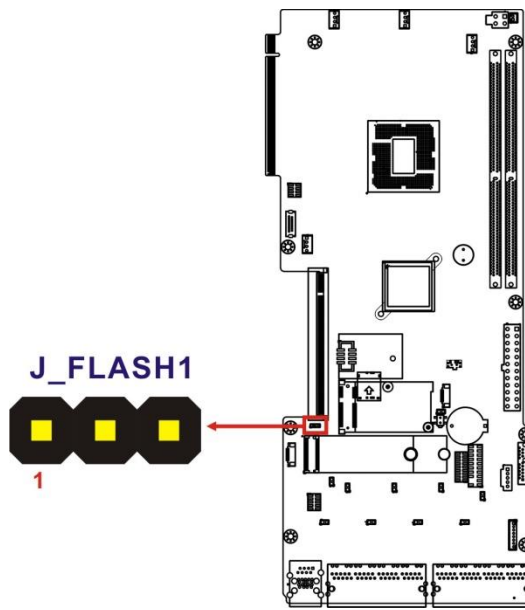

Figure 3-24: Flash Descriptor Security Override Jumper Location

To update the ME firmware, please follow the steps below.

- Step 1:** Before turning on the system power, short pin 2-3 of the jumper.
- Step 2:** Update the BIOS and ME firmware, and then turn off the system power.
- Step 3:** Remove the metal clip on the jumper or return to its default setting (short pin 1-2).
- Step 4:** Restart the system. The system will reboot 2~3 times to complete the ME firmware update.

PUZZLE-IN001

Chapter

4

BIOS

4.1 Introduction

The BIOS is programmed onto the BIOS chip. The BIOS setup program allows changes to certain system settings. This chapter outlines the options that can be changed.



NOTE:

Some of the BIOS options may vary throughout the life cycle of the product and are subject to change without prior notice.

4.1.1 Starting Setup

The UEFI BIOS is activated when the computer is turned on. The setup program can be activated in one of two ways.

1. Press the **DEL** or **F2** key as soon as the system is turned on or
2. Press the **DEL** or **F2** key when the “**Press DEL or F2 to enter SETUP**” message appears on the screen.

If the message disappears before the **DEL** or **F2** key is pressed, restart the computer and try again.

4.1.2 Using Setup

Use the arrow keys to highlight items, press **ENTER** to select, use the PageUp and PageDown keys to change entries, press **F1** for help and press **ESC** to quit. Navigation keys are shown in **Table 4-1**.

Key	Function
Up arrow	Move to previous item
Down arrow	Move to next item
Left arrow	Move to the item on the left hand side
Right arrow	Move to the item on the right hand side
+	Increase the numeric value or make changes

PUZZLE-IN001

Key	Function
-	Decrease the numeric value or make changes
Esc key	Main Menu – Quit and not save changes into CMOS Status Page Setup Menu and Option Page Setup Menu -- Exit current page and return to Main Menu
F1 key	General help, only for Status Page Setup Menu and Option Page Setup Menu
F2 key	Load previous values
F3 key	Load optimized defaults
F4 key	Save changes and exit BIOS

Table 4-1: BIOS Navigation Keys

4.1.3 Getting Help

When **F1** is pressed a small help window describing the appropriate keys to use and the possible selections for the highlighted item appears. To exit the Help Window press **Esc** or the **F1** key again.

4.1.4 Unable to Reboot after Configuration Changes

If the computer cannot boot after changes to the system configuration is made, CMOS defaults. Use the clear CMOS button described in **Chapter 3**.

4.1.5 BIOS Menu Bar

The **menu bar** on top of the BIOS screen has the following main items:

- Main – Changes the basic system configuration.
- Advanced – Changes the advanced system settings.
- Chipset – Changes the chipset settings.
- Security – Sets User and Supervisor Passwords.
- Boot – Changes the system boot configuration.
- Save & Exit – Selects exit options and loads default settings

The following sections completely describe the configuration options found in the menu items at the top of the BIOS screen and listed above.

4.2 Main

The **Main** BIOS menu (**BIOS Menu 1**) appears when the **BIOS Setup** program is entered.

The **Main** menu gives an overview of the basic system information.

```

Aptio Setup Utility - Copyright (C) 2018 American Megatrends, Inc.
Main  Advanced  Chipset  Security  Boot  Save & Exit

BIOS Information
BIOS Vendor                American Megatrends
Core Version                5.13
Compliance                 UEFI 2.6; PI 1.4
Project Version             Z532AR11.R01
Build Date and Time         09/06/2018 16:11:46

iWDD Vendor                 iEi
iWDD Version                Z532ER11.bin

Processor Information
Name                       CoffeeLake DT
Brand String                Intel(R) Core(TM)
                             i3-8100T CPU @ 3.10GHz
Frequency                  3100 MHz
ID                          0x906EB
Stepping                   B0
Number of Processors        4Core(s) / 4Thread(s)
Microcode Revision          8E
GT Info                     GT2 (0x3E91)

IGFX VBIOS Version          1010
Memory RC Version           0.7.1.58
Total Memory                16384 MB
Memory Frequency            2400 MHz

PCH Information
Name                       CNL PCH-H
PCH SKU                     C246
Stepping                    B0

ME FW Version               12.0.0.1068
ME Firmware SKU             Corporate SKU

Access Level                 Administrator

System Date                 [Thu 01/01/2018]
System Time                  [01:10:27]

-----
-><: Select Screen
^ v: Select Item
Enter: Select
+/-: Change Opt.
F1: General Help
F2: Previous Values
F3: Optimized Defaults
F4: Save & Exit
ESC: Exit

Version 2.20.1271. Copyright (C) 2018 American Megatrends, Inc.
    
```

BIOS Menu 1: Main

PUZZLE-IN001

The **Main** menu has two user configurable fields:

→ **System Date [xx/xx/xx]**

Use the **System Date** option to set the system date. Manually enter the day, month and year.

→ **System Time [xx:xx:xx]**

Use the **System Time** option to set the system time. Manually enter the hours, minutes and seconds.

4.3 Advanced

Use the **Advanced** menu (**BIOS Menu 2**) to configure the CPU and peripheral devices through the following sub-menus:



WARNING!

Setting the wrong values in the sections below may cause the system to malfunction. Make sure that the settings made are compatible with the hardware.

```

Aptio Setup Utility - Copyright (C) 2018 American Megatrends, Inc.
Main  Advanced  Chipset  Security  Boot  Save & Exit
-----
> CPU Configuration
> Trusted Computing
> iWDD H/M Monitor
> IT8528 Super IO Configuration
> Serial Port Console Redirection
> NVMe Configuration

Trusted Computing
Settings

-----
→←: Select Screen
↑ ↓: Select Item
Enter: Select
+/-: Change Opt.
F1: General Help
F2: Previous Values
F3: Optimized Defaults
F4: Save & Exit
ESC: Exit

Version 2.20.1271. Copyright (C) 2018 American Megatrends, Inc.
    
```

BIOS Menu 2: Advanced

4.3.1 CPU Configuration

Use the **CPU Configuration** menu (**BIOS Menu 3**) to view detailed CPU specifications or enable the Intel Virtualization Technology.

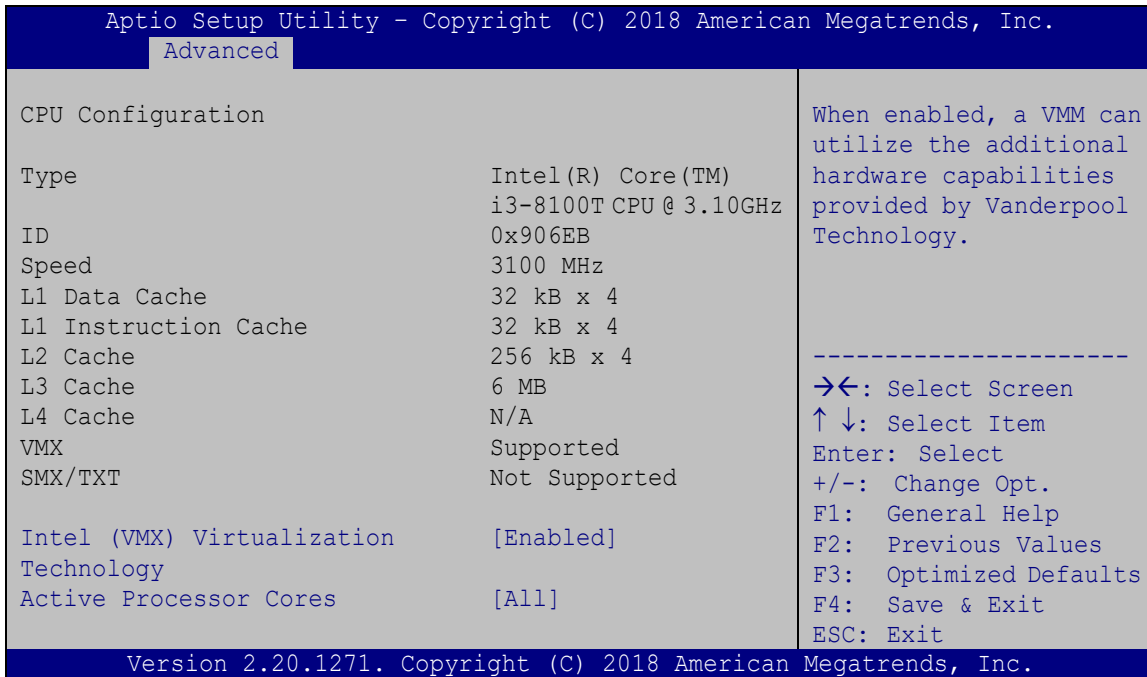

BIOS Menu 3: CPU Configuration

→ Intel (VMX) Virtualization Technology [Enabled]

Use the **Intel (VMX) Virtualization Technology** option to enable or disable virtualization on the system. When combined with third party software, Intel® Virtualization technology allows several OSs to run on the same system at the same time.

- **Disabled** Disables Intel Virtualization Technology.
- **Enabled** **DEFAULT** Enables Intel Virtualization Technology.

→ Active Processor Cores [All]

Use the **Active Processor Cores** BIOS option to enable numbers of cores in the processor package.

- **All** **DEFAULT** Enable all cores in the processor package.

PUZZLE-IN001

- ➔ 1 Enable one core in the processor package.
- ➔ 2 Enable two cores in the processor package.
- ➔ 3 Enable three cores in the processor package.

4.3.2 Trusted Computing

Use the **Trusted Computing** menu (**BIOS Menu 4**) to configure settings related to the Trusted Computing Group (TCG) Trusted Platform Module (TPM).

```

Aptio Setup Utility - Copyright (C) 2018 American Megatrends, Inc.
  Advanced
-----
Configuration
Security Device Support          [Disable]
NO Security Device Found

Enables or Disables BIOS
support for security
device. O.S. will not
show Security Device.
TCG EFI protocol and
INT1A interface will not
be available.

-----
➔←: Select Screen
↑↓: Select Item
Enter: Select
+/-: Change Opt.
F1: General Help
F2: Previous Values
F3: Optimized Defaults
F4: Save & Exit
ESC: Exit

Version 2.20.1271. Copyright (C) 2018 American Megatrends, Inc.
  
```

BIOS Menu 4: Trusted Computing

➔ Security Device Support [Disable]

Use the **Security Device Support** option to configure support for the TPM.

- ➔ **Disable** **DEFAULT** TPM support is disabled.
- ➔ **Enable** TPM support is enabled.

4.3.3 iWDD H/W Monitor

The **iWDD H/W Monitor** menu (**BIOS Menu 5**) contains the fan configuration submenu, and displays the system temperature and CPU fan speed.

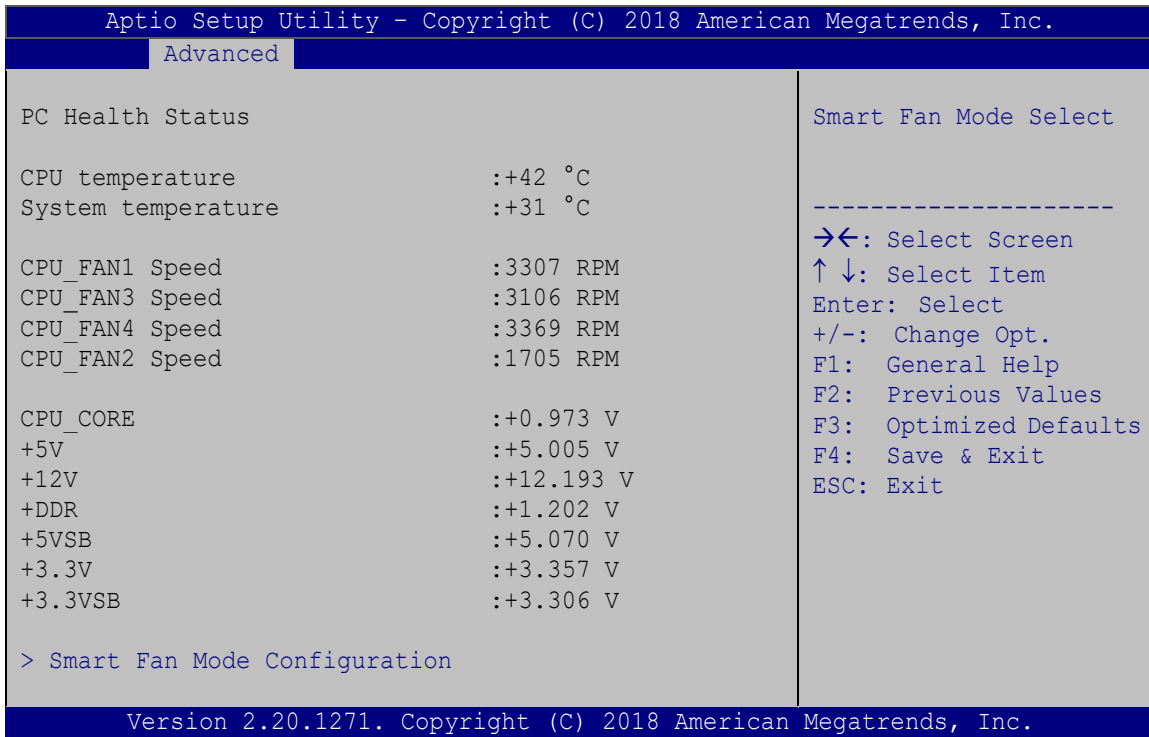

BIOS Menu 5: iWDD H/W Monitor

➔ PC Health Status

The following system parameters and values are shown. The system parameters that are monitored are:

- System Temperatures:
 - CPU Temperature
 - System Temperature
- Fan Speeds:
 - CPU Fan Speed
- Voltages:
 - CPU_CORE
 - +5V

PUZZLE-IN001

- +12V
- DDR
- +5VSB
- +3.3V
- +3.3VSB

4.3.3.1 Smart Fan Mode Configuration

Use the **Smart Fan Mode Configuration** submenu (**BIOS Menu 6**) to configure the CPU/system fan temperature and speed settings.

```

Aptio Setup Utility - Copyright (C) 2018 American Megatrends, Inc.
-----
Advanced
-----
Smart Fan Mode Configuration
CPU_FAN1 Smart Fan Control      [Auto Mode]
Auto mode fan start temperature 60
Auto mode fan off temperature  40
Auto mode fan start PWM        30
Auto mode fan slope PWM        3

CPU_FAN3 Smart Fan Control      [Auto Mode]
Auto mode fan start temperature 60
Auto mode fan off temperature  40
Auto mode fan start PWM        30
Auto mode fan slope PWM        1

Smart Fan Mode Select
-----
-><-: Select Screen
↑ ↓: Select Item
Enter: Select
+/-: Change Opt.
F1: General Help
F2: Previous Values
F3: Optimized Defaults
F4: Save & Exit
ESC: Exit

Version 2.20.1271. Copyright (C) 2018 American Megatrends, Inc.
    
```

BIOS Menu 6: Smart Fan Mode Configuration

→ CPU_FAN Smart Fan Control [Auto Mode]

Use the **CPU_FAN Smart Fan Control** options to configure the CPU Smart Fans.

- **Manual Mode** The fan spins at the speed set in Manual Mode settings.
- **Auto Mode** **DEFAULT** The fan adjusts its speed using Auto Mode settings.

The following options can only be set if the CPU Smart Fan Control option is set to Auto Mode.

→ **Auto mode fan start temperature**

If the CPU temperature is between **fan off** and **fan start**, the fan speed change to **fan start PWM**. To set a value, Use the + or – key to change the value or enter a decimal number between 1 and 100.

→ **Auto mode fan off temperature**

If the CPU temperature is lower than the value set this option, the fan speed change to be lowest. To set a value, Use the + or – key to change the value or enter a decimal number between 1 and 100.

→ **Auto mode fan start PWM**

Use the **Auto mode fan start PWM** option to set the PWM start value. Use the + or – key to change the value or enter a decimal number between 1 and 100.

→ **Auto mode fan slope PWM**

Use the **Auto mode fan slope PWM** option to select the linear rate at which the PWM mode increases with respect to an increase in temperature. Use the + or – key to change the value or enter a decimal number between 1 and 8.

PUZZLE-IN001

4.3.4 IT8528 Super IO Configuration

Use the **IT8528 Super IO Configuration** menu (**BIOS Menu 7**) to set or change the configurations for the parallel ports and serial ports.

```

Aptio Setup Utility - Copyright (C) 2018 American Megatrends, Inc.
  Advanced
Super IO Configuration
Super IO Chip                IT8528
> Serial Port 1 Configuration

Set Parameters of Serial
Port 1 (COMA)
-----
-><: Select Screen
↑↓: Select Item
Enter: Select
+/-: Change Opt.
F1: General Help
F2: Previous Values
F3: Optimized Defaults
F4: Save & Exit
ESC: Exit

Version 2.20.1271. Copyright (C) 2018 American Megatrends, Inc.
  
```

BIOS Menu 7: IT8528 Super IO Configuration

4.3.4.1 Serial Port 1 Configuration

Use the **Serial Port 1 Configuration** menu (**BIOS Menu 8**) to configure the serial port n.

```

Aptio Setup Utility - Copyright (C) 2018 American Megatrends, Inc.
  Advanced
Serial Port n Configuration
Serial Port                [Enabled]
Device Settings            IO=3F8h; IRQ=4

Enable or Disable Serial
Port (COM)
-----
-><: Select Screen
↑↓: Select Item
Enter: Select
+/-: Change Opt.
F1: General Help
F2: Previous Values
F3: Optimized Defaults
F4: Save & Exit
ESC: Exit

Version 2.20.1271. Copyright (C) 2018 American Megatrends, Inc.
  
```

BIOS Menu 8: Serial Port 1 Configuration Menu

➔ **Serial Port [Enabled]**

Use the **Serial Port** option to enable or disable the serial port.

- ➔ **Disabled** Disable the serial port
- ➔ **Enabled** **DEFAULT** Enable the serial port

4.3.5 Serial Port Console Redirection

The **Serial Port Console Redirection** menu (**BIOS Menu 9**) allows the console redirection options to be configured. Console redirection allows users to maintain a system remotely by re-directing keyboard input and text output through the serial port.

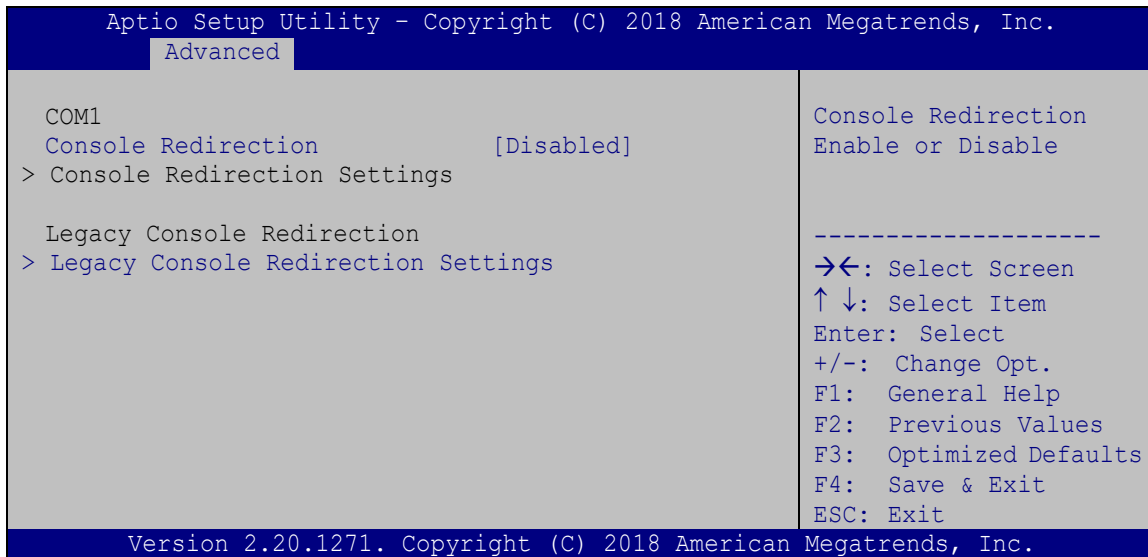

BIOS Menu 9: Serial Port Console Redirection

➔ **Console Redirection [Enabled]**

Use **Console Redirection** option to enable or disable the console redirection function.

- ➔ **Disabled** Disabled the console redirection function
- ➔ **Enabled** **DEFAULT** Enabled the console redirection function

The following options are available in the **Console Redirection Settings** submenu when the **Console Redirection** option is enabled.

PUZZLE-IN001**→ Terminal Type [ANSI]**

Use the **Terminal Type** option to specify the remote terminal type.

- **VT100** The target terminal type is VT100
- **VT100+** The target terminal type is VT100+
- **VT-UTF8** The target terminal type is VT-UTF8
- **ANSI** **DEFAULT** The target terminal type is ANSI

→ Bits per second [115200]

Use the **Bits per second** option to specify the serial port transmission speed. The speed must match the other side. Long or noisy lines may require lower speeds.

- **9600** Sets the serial port transmission speed at 9600.
- **19200** Sets the serial port transmission speed at 19200.
- **57600** Sets the serial port transmission speed at 57600.
- **115200** **DEFAULT** Sets the serial port transmission speed at 115200.

→ Data Bits [8]

Use the **Data Bits** option to specify the number of data bits.

- **7** Sets the data bits at 7.
- **8** **DEFAULT** Sets the data bits at 8.

→ Parity [None]

Use the **Parity** option to specify the parity bit that can be sent with the data bits for detecting the transmission errors.

- **None** **DEFAULT** No parity bit is sent with the data bits.
- **Even** The parity bit is 0 if the number of ones in the data bits is even.

- ➔ **Odd** The parity bit is 0 if the number of ones in the data bits is odd.
- ➔ **Mark** The parity bit is always 1. This option does not provide error detection.
- ➔ **Space** The parity bit is always 0. This option does not provide error detection.

➔ **Stop Bits [1]**

Use the **Stop Bits** option to specify the number of stop bits used to indicate the end of a serial data packet. Communication with slow devices may require more than 1 stop bit.

- ➔ **1** **DEFAULT** Sets the number of stop bits at 1.
- ➔ **2** Sets the number of stop bits at 2.

4.3.5.1 Legacy Console Redirection Settings

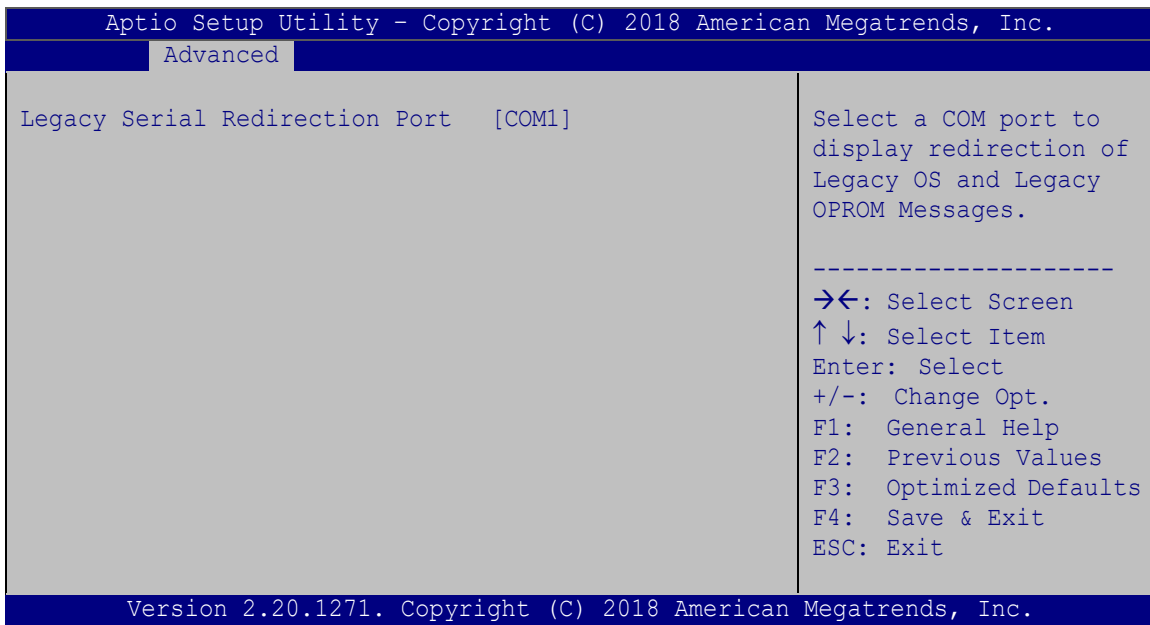

BIOS Menu 10: Legacy Console Redirection Settings

PUZZLE-IN001

→ Legacy Serial Redirection Port [COM1]

Use the **Legacy Serial Redirection Port** option to select a COM port to display redirection of legacy OS and legacy OPRM messages. Configuration option is listed below.

- COM1 **Default**

4.3.6 NVMe Configuration

Use the **NVMe Configuration (BIOS Menu 11)** menu to display the NVMe controller and device information.

```
Aptio Setup Utility - Copyright (C) 2018 American Megatrends, Inc.
  Advanced
NVMe Configuration
No NVMe Device Found

-----
→←: Select Screen
↑↓: Select Item
Enter: Select
+/-: Change Opt.
F1: General Help
F2: Previous Values
F3: Optimized Defaults
F4: Save & Exit
ESC: Exit
Version 2.20.1271. Copyright (C) 2018 American Megatrends, Inc.
```

BIOS Menu 11: NVMe Configuration

4.4 Chipset

Use the **Chipset** menu (**BIOS Menu 12**) to access the PCH IO and System Agent (SA) configuration menus.



WARNING!

Setting the wrong values for the Chipset BIOS selections in the Chipset BIOS menu may cause the system to malfunction.

```
Aptio Setup Utility - Copyright (C) 2018 American Megatrends, Inc.
Main   Advanced  Chipset  Security  Boot   Save & Exit
-----
> System Agent (SA) Configuration      System Agent (SA)
> PCH-IO Configuration                 Parameters
-----
-><: Select Screen
↑↓: Select Item
Enter: Select
+/-: Change Opt.
F1: General Help
F2: Previous Values
F3: Optimized Defaults
F4: Save & Exit
ESC: Exit

Version 2.20.1271. Copyright (C) 2018 American Megatrends, Inc.
```

BIOS Menu 12: Chipset

PUZZLE-IN001

4.4.1 System Agent (SA) Configuration

Use the **System Agent (SA) Configuration** menu (**BIOS Menu 13**) to configure the System Agent (SA) parameters.

```

Aptio Setup Utility - Copyright (C) 2018 American Megatrends, Inc.
  Chipset
System Agent (SA) Configuration
VT-d                Supported
VT-d                [Enabled]
> Memory Configuration
> Graphics Configuration
> PEG Port Configuration
VT-d capability
-----
-><: Select Screen
↑ ↓: Select Item
Enter: Select
+/-: Change Opt.
F1:  General Help
F2:  Previous Values
F3:  Optimized Defaults
F4:  Save & Exit
ESC: Exit
Version 2.20.1271. Copyright (C) 2018 American Megatrends, Inc.
  
```

BIOS Menu 13: System Agent (SA) Configuration

→ VT-d [Enabled]

Use the **VT-d** option to enable or disable VT-d capability.

- **Disabled** Disables VT-d capability.
- **Enabled** **DEFAULT** Enables VT-d capability.

4.4.1.1 Memory Configuration

Use the **Memory Configuration** submenu (**BIOS Menu 14**) to view memory information.

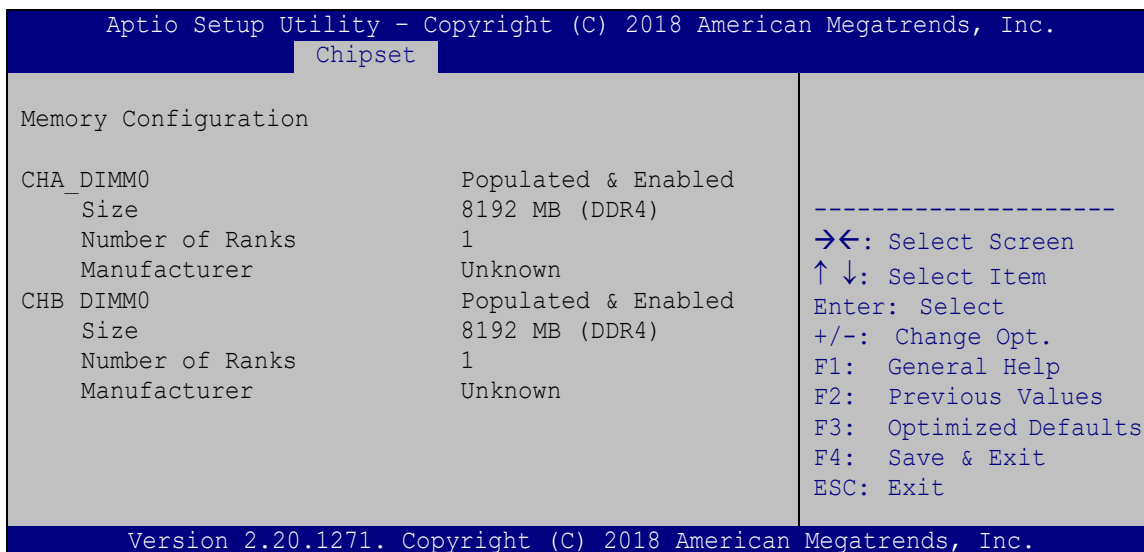

BIOS Menu 14: Memory Configuration

4.4.1.2 Graphics Configuration

Use the **Graphics Configuration (BIOS Menu 15)** menu to configure the video device connected to the system.

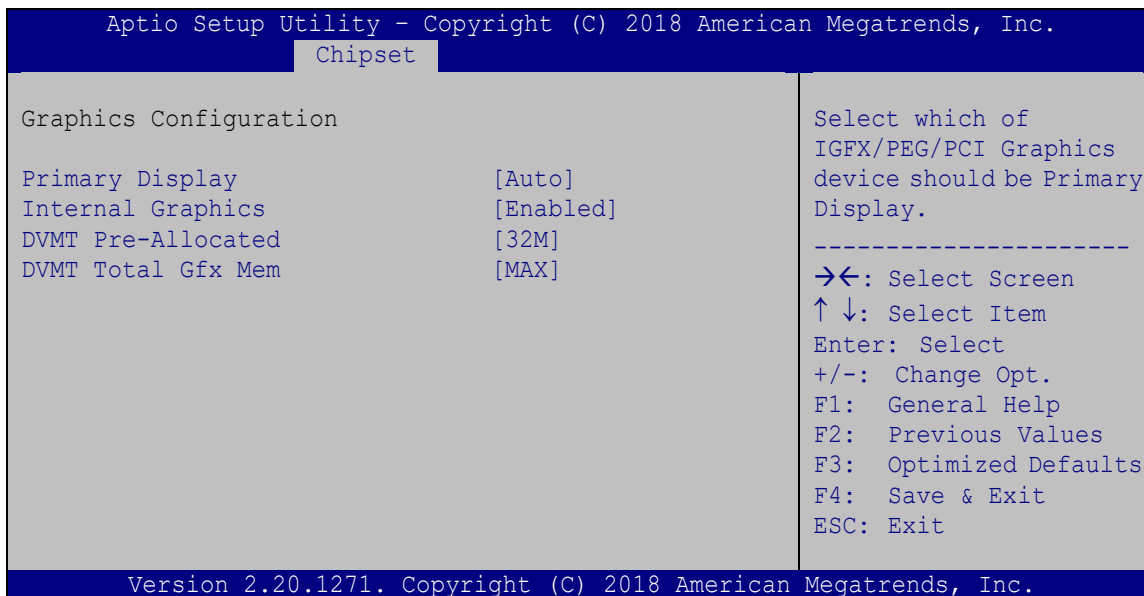

BIOS Menu 15: Graphics Configuration

PUZZLE-IN001**→ Primary Display [Auto]**

Use the **Primary Display** option to select the primary graphics controller the system uses.

The following options are available:

- Auto **Default**
- IGFX
- PEG
- PCIe

→ Internal Graphics [Enabled]

Use the **Internal Graphics** option to keep IGFX enabled basing on the setup options. The following options are available:

- Auto
- Disabled
- Enabled **Default**

→ DVMT Pre-Allocated [32M]

Use the **DVMT Pre-Allocated** option to set the amount of system memory allocated to the integrated graphics processor when the system boots. The system memory allocated can then only be used as graphics memory, and is no longer available to applications or the operating system. Configuration options are listed below:

- 32M **Default**
- 64M

→ DVMT Total Gfx Mem [MAX]

Use the **DVMT Total Gfx Mem** option to select DVMT5.0 total graphic memory size used by the internal graphic device. The following options are available:

- 128M
- 256M
- MAX **Default**

4.4.1.3 PEG Port Configuration

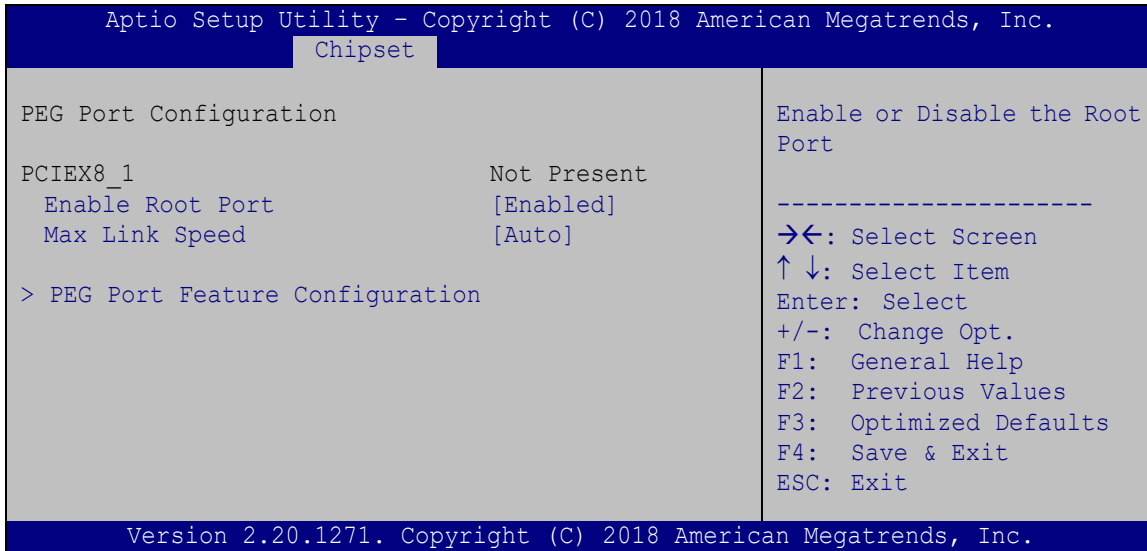

BIOS Menu 16: PEG Port Configuration

→ Enable Root Port [Enabled]

Use the **Enable Root Port** option to enable or disable the PCI Express (PEG) controller.

- **Disabled** Disables the PCI Express (PEG) controller.
- **Enabled** **DEFAULT** Enables the PCI Express (PEG) controller.

→ Max Link Speed [Auto]

Use the **Max Link Speed** option to select the maximum link speed of the PCI Express slot.

The following options are available:

- Auto **Default**
- Gen1
- Gen2
- Gen3

PUZZLE-IN001

4.4.2 PCH-IO Configuration

Use the **PCH-IO Configuration** menu (**BIOS Menu 17**) to configure the PCH parameters.

```

Aptio Setup Utility - Copyright (C) 2018 American Megatrends, Inc.
Chipset
PCH-IO Configuration
Auto Power Button Status      [Disable (ATX)]
Restore AC Power Loss         [Last State]

> PCI Express Configuration
> SATA And RST Configuration
> NETWORK Configuration (ByPass Setting)

M.2 B Key (M2_1) device selection [SATA]

Module B Configuration        [PCIEx4 x 2]

Select AC power state
when power is re-applied
after a power failure.

-----
-><: Select Screen
↑↓: Select Item
Enter: Select
+/-: Change Opt.
F1: General Help
F2: Previous Values
F3: Optimized Defaults
F4: Save & Exit
ESC: Exit

Version 2.20.1271. Copyright (C) 2018 American Megatrends, Inc.
  
```

BIOS Menu 17: PCH-IO Configuration

→ Restore AC Power Loss [Last State]

Use the **Restore AC Power Loss** BIOS option to specify what state the system returns to if there is a sudden loss of power to the system.

- **Power Off** The system remains turned off
- **Power On** The system turns on
- **Last State** **DEFAULT** The system returns to its previous state. If it was on, it turns itself on. If it was off, it remains off.

→ M.2 B Key (M2_1) device selection [SATA]

Use the **M.2 B Key (M2_1) device selection [SATA]** BIOS option to configure M.2 device as SATA or PCIe device.

- **SATA** **DEFAULT** Configure M.2 device as SATA device.
- **PCIe** Configure M.2 device as PCIe device.

4.4.2.1 PCI Express Configuration

Use the **PCI Express Configuration** menu (**BIOS Menu 18**) to configure the PCI Express slot.

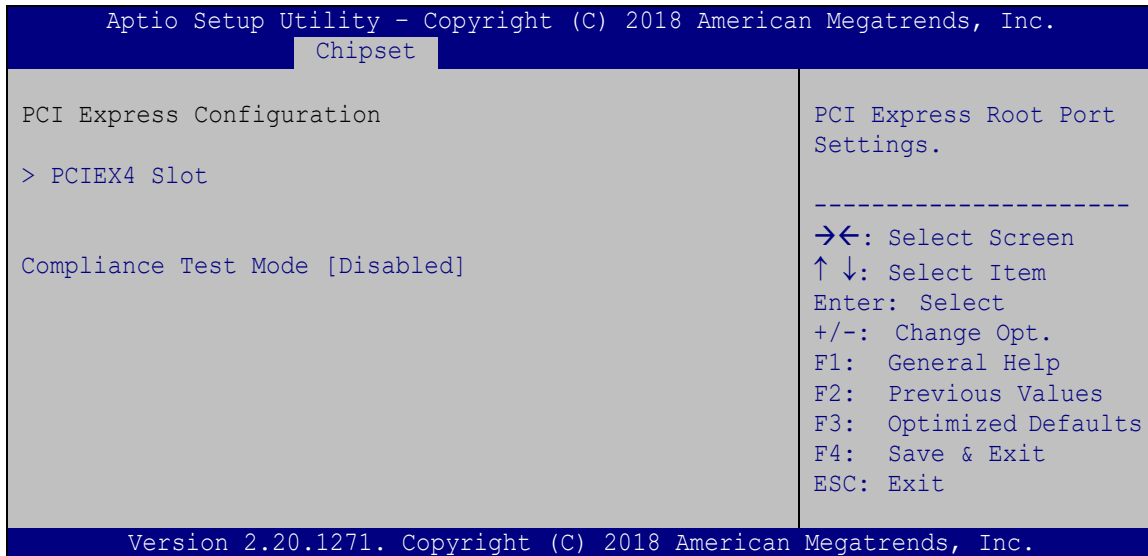

BIOS Menu 18: PCI Express Configuration

→ Compliance Test Mode [Disabled]

Use the **Compliance Test Mode** option to enable or disable detecting if a non-compliance PCI Express device is connected to the PCI Express slot.

- **Disabled** **DEFAULT** Disables to detect if a non-compliance PCI Express device is connected to the PCI Express slot.
- **Enabled** Enables to detect if a non-compliance PCI Express device is connected to the PCI Express slot.

PUZZLE-IN001

4.4.2.1.1 PCIEX4 Slot

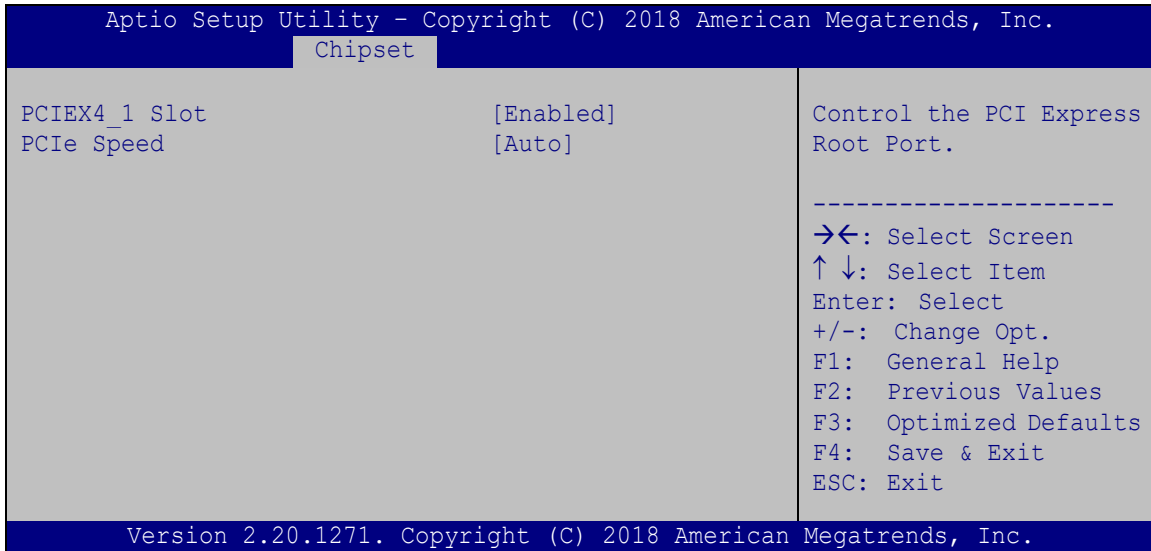

BIOS Menu 19: PCIEX4 Slot

→ PCIEX4_1 Slot [Enabled]]

Use the **PCIEX4_1 Slot** option to enable or disable the PCIe x4 slot (PCIEX4_1).

- **Disabled** Disables the PCIe x4 slot.
- **Enabled** **DEFAULT** Enables the PCIe x4 slot.

→ PCIe Speed [Auto]

Use this option to select the support type of the PCI Express slots. The following options are available:

- Auto **Default**
- Gen1
- Gen2
- Gen3

4.4.2.2 SATA and RST Configuration

Use the **SATA and RST Configuration** menu (**BIOS Menu 20**) to change and/or set the configuration of the SATA devices installed in the system.

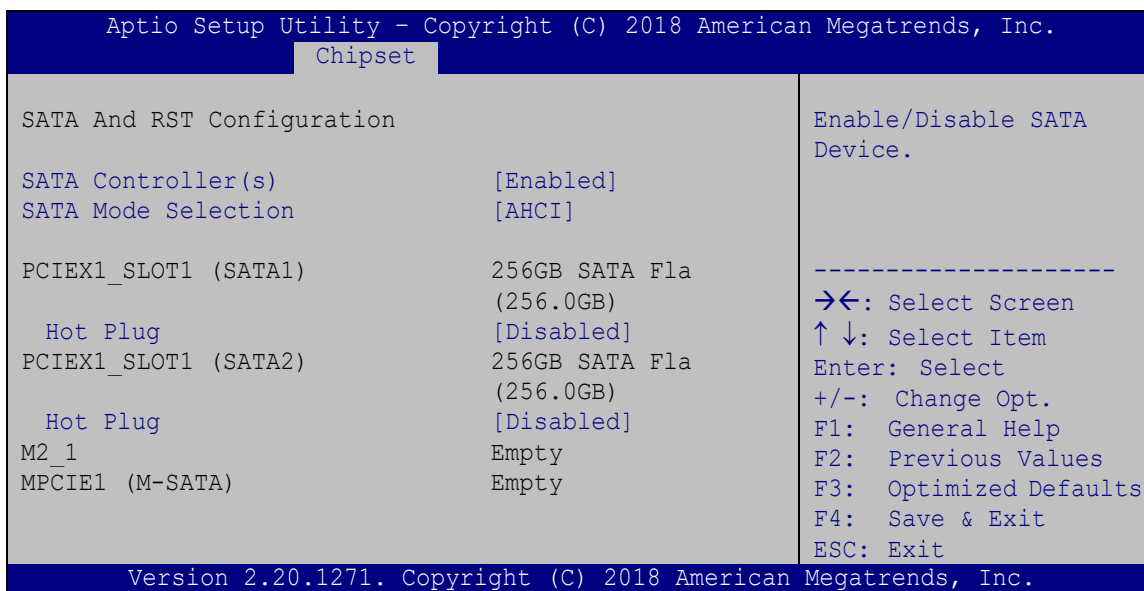

BIOS Menu 20: SATA and RST Configuration

→ SATA Controller(s) [Enabled]

Use the **SATA Controller(s)** option to configure the SATA controller(s).

- **Enabled** **DEFAULT** Enables the on-board SATA controller(s).
- **Disabled** Disables the on-board SATA controller(s).

PUZZLE-IN001**→ SATA Mode Selection [AHCI]**

Use the **SATA Mode Selection** option to determine how the SATA devices operate.

- AHCI** **DEFAULT** Configures SATA devices as AHCI device.
- Intel RST Premium With Intel Optane System Acceleration** Configures SATA devices to the Intel RST Premium With Intel Optane System Acceleration mode.

→ Hot Plug

Use the **Hot Plug** option to enable or disable the hot plug function.

- Disabled** **DEFAULT** Disables the hot plug function.
- Enabled** Enables the hot plug function.

4.4.2.3 Network Configuration (Bypass Setting)

Use the **Network Configuration (Bypass Setting)** menu (**BIOS Menu 21**) to configure the bypass settings of the IEI networking module slots.

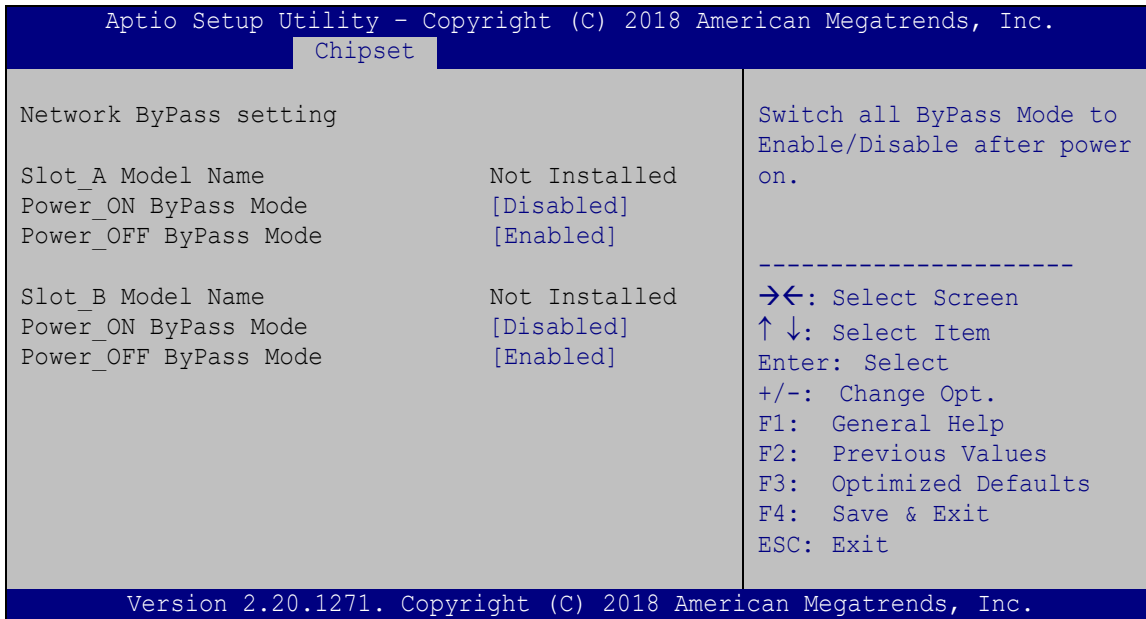

BIOS Menu 21: Network Configuration (Bypass Setting)

→ Power_ON ByPass Mode [Disabled]

Use the **Power_ON ByPass Mode** option to enable or disable bypass function of the installed PuIM module when the PUZZLE-IN001 is on.

- **Disabled** **DEFAULT** Bypass is disabled when the system is on.
- **Enabled** Bypass is enabled when the system is on.

→ Power_OFF ByPass Mode [Enabled]

Use the **Power_OFF ByPass Mode** option to enable or disable bypass function of the installed PuIM module when the PUZZLE-IN001 is off.

- **Disabled** **DEFAULT** Bypass is disabled when the system is off.
- **Enabled** Bypass is enabled when the system is off.

PUZZLE-IN001

4.5 Security

Use the **Security** menu (**BIOS Menu 22**) to set system and user passwords.

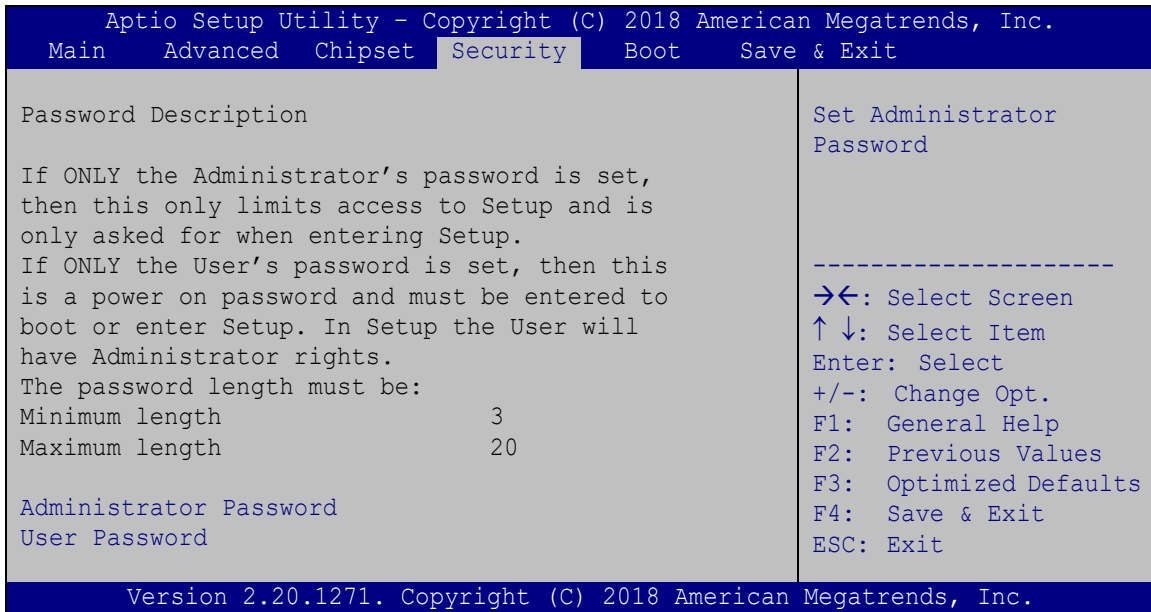

BIOS Menu 22: Security

→ Administrator Password

Use the **Administrator Password** to set or change a administrator password.

→ User Password

Use the **User Password** to set or change a user password.

4.6 Boot

Use the **Boot** menu (**BIOS Menu 23**) to configure system boot options.

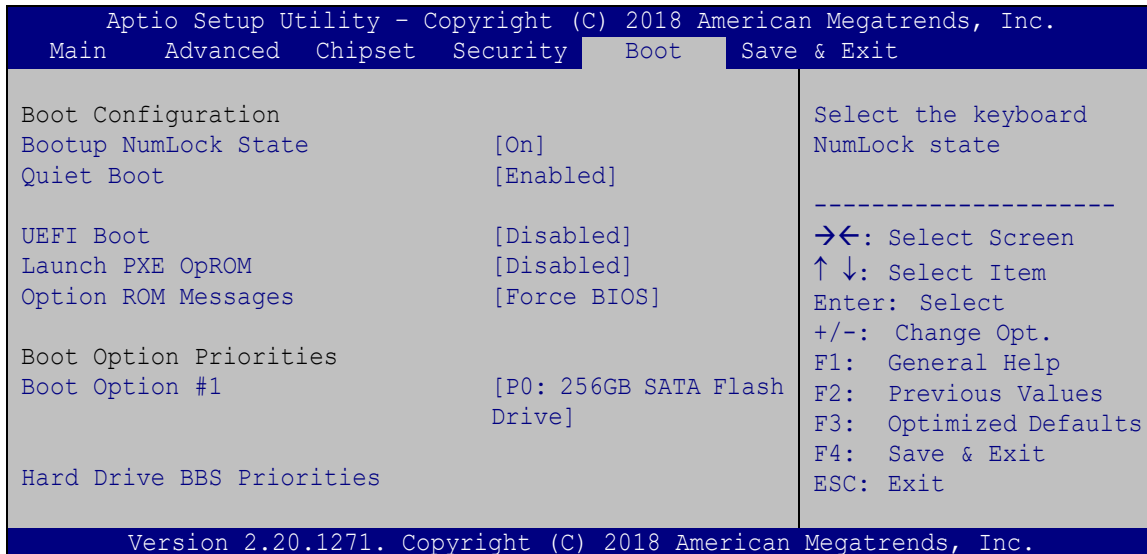

BIOS Menu 23: Boot

→ Bootup NumLock State [On]

Use the **Bootup NumLock State** BIOS option to specify if the number lock setting must be modified during boot up.

- **On** **DEFAULT** Allows the Number Lock on the keyboard to be enabled automatically when the computer system boots up. This allows the immediate use of the 10-key numeric keypad located on the right side of the keyboard. To confirm this, the Number Lock LED light on the keyboard is lit.

- **Off** Does not enable the keyboard Number Lock automatically. To use the 10-keys on the keyboard, press the Number Lock key located on the upper left-hand corner of the 10-key pad. The Number Lock LED on the keyboard lights up when the Number Lock is engaged.

PUZZLE-IN001**→ Quiet Boot [Enabled]**

Use the **Quiet Boot** BIOS option to select the screen display when the system boots.

- **Disabled** Normal POST messages displayed
- **Enabled** **DEFAULT** OEM Logo displayed instead of POST messages

→ UEFI Boot [Disabled]

Use the **UEFI Boot** option to enable or disable to boot from the UEFI devices.

- **Disabled** **DEFAULT** Boot from UEFI devices is disabled.
- **Enabled** Boot from UEFI devices is enabled.

→ Launch PXE OpROM [Disabled]

Use the **Launch PXE OpROM** option to enable or disable boot option for legacy network devices.

- **Disabled** **DEFAULT** Ignore all PXE Option ROMs
- **Enabled** Load PXE Option ROMs.

→ Option ROM Messages [Force BIOS]

Use the **Option ROM Messages** option to set the Option ROM display mode.

- **Force BIOS** **DEFAULT** Sets display mode to force BIOS.
- **Keep Current** Sets display mode to current.

4.7 Save & Exit

Use the **Safe & Exit** menu (**BIOS Menu 24**) to load default BIOS values, optimal failsafe values and to save configuration changes.

```
Aptio Setup Utility - Copyright (C) 2018 American Megatrends, Inc.
Main   Advanced  Chipset  Security  Boot   Save & Exit
-----
Save Changes and Reset
Discard Changes and Reset

Restore Defaults
Save as User Defaults
Restore User Defaults

Exit the system after
saving the changes.

-----
-><: Select Screen
↑↓: Select Item
Enter: Select
+/-: Change Opt.
F1: General Help
F2: Previous Values
F3: Optimized Defaults
F4: Save & Exit
ESC: Exit

Version 2.20.1271. Copyright (C) 2018 American Megatrends, Inc.
```

BIOS Menu 24: Save & Exit

→ Save Changes and Reset

Use the **Save Changes and Reset** option to save the changes made to the BIOS options and reset the system.

→ Discard Changes and Reset

Use the **Discard Changes and Reset** option to exit the system without saving the changes made to the BIOS configuration setup program.

→ Restore Defaults

Use the **Restore Defaults** option to load the optimal default values for each of the parameters on the Setup menus. **F3 key can be used for this operation.**

→ Save as User Defaults

Use the **Save as User Defaults** option to save the changes done so far as user defaults.

→ Restore User Defaults

Use the **Restore User Defaults** option to restore the user defaults to all the setup options.

Chapter

5

Interface Connectors

5.1 Peripheral Interface Connectors

The connector locations of the PUZZLE-IN001's motherboard are shown below. The connector pinouts for these connectors are listed in the following sections.

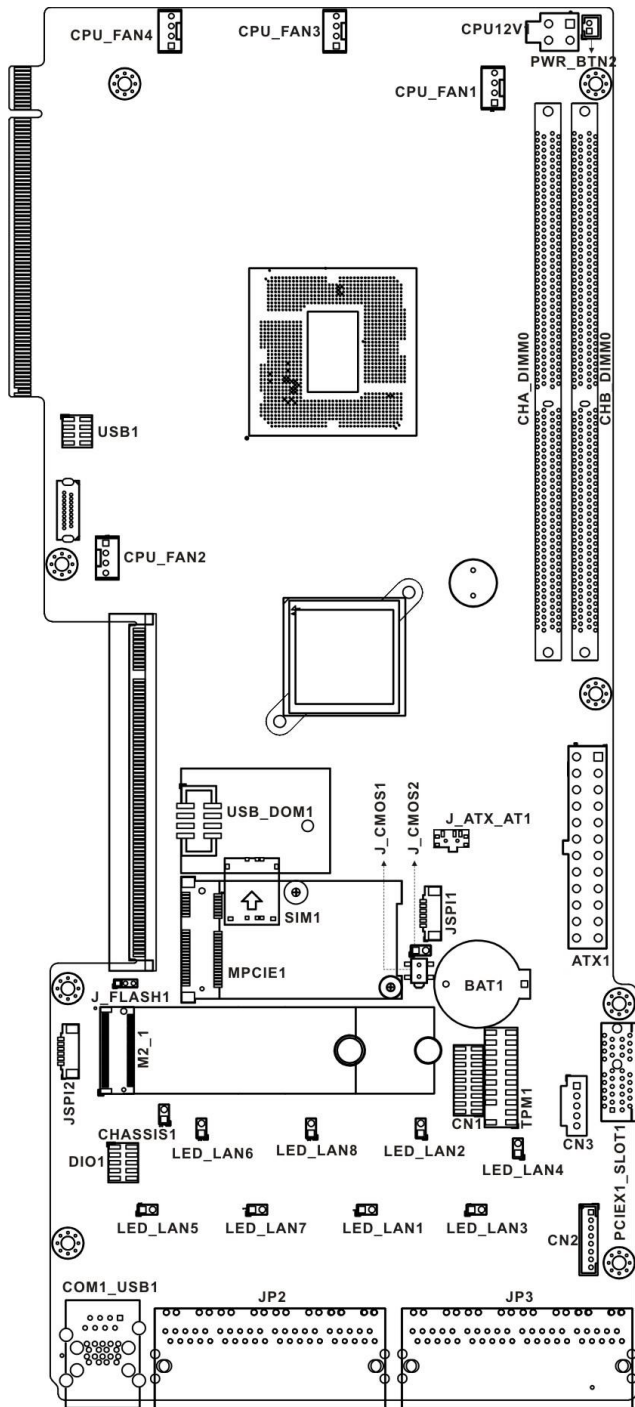

PUZZLE-IN001

5.2 Internal Peripheral Connectors

Internal peripheral connectors on the motherboard and are only accessible when the motherboard is outside of the chassis. The table below shows a list of the connectors on the motherboard. Pinouts of these connectors can be found in the following sections.

Connector	Type	Label
ATX power connector	24-pin connector	ATX1
ATX PSU SMBus connector	5-pin wafer	CN3
CPU power connector	4-pin connector	CPU12V1
Chassis intrusion connector	2-pin header	CHASSIS1
Digital I/O connector	10-pin header	DIO1
EC debug connector	18-pin header	CN1
Fan connectors	4-pin wafer	CPU_FAN1, CPU_FAN2, CPU_FAN3, CPU_FAN4
LCM connector	8-pin wafer	CN2
LAN LED connector	2-pin header	LED_LAN1, LED_LAN2, LED_LAN3, LED_LAN4, LED_LAN5, LED_LAN6, LED_LAN7, LED_LAN8
M.2 B-key slot	M.2 B-key 2260/3042	M2_1
Memory slots	DDR4 DIMM slot	CHA_DIMM0, CHB_DIMM0
PCIe Mini slot	Full/Half-size PCIe Mini	MPCIE1
Power button connector	2-pin wafer	PWR_BTN2
SATA 6Gb/s socket	36-pin socket	PCIEX1_SLOT1
SPI flash connector	6-pin wafer	JSPI1
SPI flash connector (EC)	6-pin wafer	JSPI2
TPM connector	20-pin header	TPM1
USB 2.0 connector	8-pin header	USB1

Table 5-1: Peripheral Interface Connectors

5.2.1 ATX Power Connector (ATX1)

Pin	Description	Pin	Description
1	+3.3 V	13	+3.3 V
2	+3.3 V	14	-12 V
3	GND	15	GND
4	+5 V	16	PS-ON
5	GND	17	GND
6	+5 V	18	GND
7	GND	19	GND
8	PW-OK	20	N/C
9	+5VSB	21	+5 V
10	+12V	22	+5 V
11	+12V	23	+5 V
12	+3.3 V	24	GND

Table 5-2: ATX Power Connector Pinouts

5.2.2 ATX PSU SMBus Connector (CN3)

PIN NO.	DESCRIPTION
1	SMCLK0_EC
2	SMDAT0_EC
3	NC
4	GND
5	NC

Table 5-3: ATX PSU SMBus Connector (CN3) Pinouts

5.2.3 CPU Power Connector (CPU12V1)

Pin	Description
1	GND
2	GND
3	+12 V

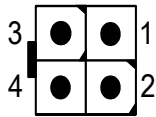

The diagram shows a square connector with four pins arranged in a 2x2 grid. The top-left pin is labeled '3', the top-right pin is labeled '1', the bottom-left pin is labeled '4', and the bottom-right pin is labeled '2'.

PUZZLE-IN001

Pin	Description
4	+12 V

Table 5-4: CPU Power Connector Pinouts

5.2.4 Chassis Intrusion Connector (CHASSIS1)

PIN NO.	DESCRIPTION
1	+3.3VSB
2	CHASSIS OPEN

Table 5-5: Chassis Intrusion Connector (CHASSIS1) Pinouts

5.2.5 DIO Connector (DIO1)

PIN NO.	DESCRIPTION	PIN NO.	DESCRIPTION
1	GND	2	VCC
3	Output 3	4	Output 2
5	Output 1	6	Output 0
7	Input 3	8	Input 2
9	Input 1	10	Input 0

Table 5-6: DIO Connector (DIO1) Pinouts

5.2.6 EC Debug Connector (CN1)

PIN NO.	DESCRIPTION	PIN NO.	DESCRIPTION
1	EC_EPP_STB#	2	EC_EPP_AFD#
3	EC_EPP_PD0	4	NC
5	EC_EPP_PD1	6	EC_EPP_INIT#
7	EC_EPP_PD2	8	EC_EPP_SLIN#
9	EC_EPP_PD3	10	GND
11	EC_EPP_PD4	12	NC
13	EC_EPP_PD5	14	EC_EPP_BUSY
15	EC_EPP_PD6	16	EC_EPP_KSI5

PIN NO.	DESCRIPTION	PIN NO.	DESCRIPTION
17	EC_EPP_PD7	18	EC_EPP_KSI4

Table 5-7: EC Debug Connector (CN1) Pinouts

5.2.7 Fan Connectors (CPU_FAN1/2/3/4)

PIN NO.	DESCRIPTION
1	GND
2	+12V
3	FANIO
4	PWM

Table 5-8: Fan Connectors (CPU_FAN1/2/3/4) Pinouts

5.2.8 LCM Connector (CN2)

PIN NO.	DESCRIPTION
1	VCC5V
2	Power button
3	LCM RX
4	LCM TX
5	HDD LED
6	Alert LED
7	Reset button
8	GND

Table 5-9: LCM Connector (CN2) Pinouts

5.2.9 LAN LED Connector (LED_LAN1/2/3/4/5/6/7/8)

PIN NO.	DESCRIPTION
1	+3.3V
2	LAN1_LED_LNK#_ACT

Table 5-10: LAN LED Connector (LED_LAN1/2/3/4/5/6/7/8) Pinouts

5.2.10 M.2 Slot (M2_1)

PIN NO.	DESCRIPTION	PIN NO.	DESCRIPTION
1	CONFIG_3	2	+3.3V
3	GND	4	+3.3V
5	GND	6	N/C
7	USB_D+	8	N/C
9	USB_D-	10	N/C
11	Notch	12	Notch
13	Notch	14	Notch
15	Notch	16	Notch
17	Notch	18	Notch
19	Notch	20	N/C
21	CONFIG_0	22	N/C
23	N/C	24	N/C
25	N/C	26	N/C
27	GND	28	N/C
29	USB3.0-RX-	30	N/C
31	USB3.0-RX+	32	N/C
33	GND	34	N/C
35	USB3.0-TX-	36	N/C
37	USB3.0-TX+	38	N/C
39	GND	40	N/C
41	PETN0/SATA-B+	42	N/C
43	PETP0/SATA-B-	44	N/C
45	GND	46	N/C
47	PERN0/SATA-A-	48	N/C
49	PERP0/SATA-A+	50	PERST#
51	GND	52	CLKREQ#
53	REFCLKN	54	PEWAKE
55	REFCLKP	56	N/C

PIN NO.	DESCRIPTION	PIN NO.	DESCRIPTION
57	GND	58	N/C
59	N/C	60	N/C
61	N/C	62	N/C
63	N/C	64	N/C
65	N/C	66	N/C
67	PESET_N	68	N/C
69	N/C	70	+3.3V
71	GND	72	+3.3V
73	GND	74	+3.3V
75	N/C		

Table 5-11: M.2 Slot (M2_1) Pinouts

5.2.11 PCIe Mini Card Slot (MPCIE1)

PIN NO.	DESCRIPTION	PIN NO.	DESCRIPTION
1	PCIE_WAKE#	2	+3.3V
3	N/C	4	GND
5	N/C	6	1.5V
7	N/C	8	N/C
9	GND	10	N/C
11	MSATA_CLK#	12	N/C
13	MSATA_CLK	14	N/C
15	GND	16	N/C
17	PLTRST_N	18	GND
19	N/C	20	+3.3V
21	GND	22	PLTRST_N
23	PERN0/SATA_RX+	24	+3.3V
25	PERP0/SATA_RX-	26	GND
27	GND	28	1.5V
29	GND	30	SMB_CLK
31	PETN0/SATA_TX-	32	SMB_DATA

PUZZLE-IN001

PIN NO.	DESCRIPTION	PIN NO.	DESCRIPTION
33	PETP0/SATA_TX+	34	GND
35	GND	36	USB_DATA-
37	GND	38	USB_DATA+
39	+3.3V	40	GND
41	+3.3V	42	N/C
43	+3.3V	44	N/C
45	CLINK_CLK	46	N/C
47	CLINK_DATA	48	1.5V
49	CLINK_RST#	50	GND
51	MSATA_DET	52	+3.3V

Table 5-12: PCIe Mini Card Slot (MPCIE1) Pinouts

5.2.12 Power Button Connector (PWR_BTN2)

PIN NO.	DESCRIPTION
1	PWRBTN_SW#
2	GND

Table 5-13: Power Button Connector (PWR_BTN2) Pinouts

5.2.13 SATA Connector (PCIEX1_SLOT1)

PIN NO.	DESCRIPTION	PIN NO.	DESCRIPTION
B1	+V12S	A1	N/C
B2	+V12S	A2	+V12S
B3	+V12S	A3	+V12S
B4	GND	A4	GND
B5	SATA_TX2-	A5	+V5S
B6	SATA_TX2+	A6	+V5S
B7	GND	A7	SATA_RX2-
B8	+V3.3S	A8	SATA RX2+
B9	+V5S	A9	+V3.3S
B10	N/C	A10	+V3.3S

PIN NO.	DESCRIPTION	PIN NO.	DESCRIPTION
B11	+V5S	A11	+V5S
B12	+V5S	A12	GND
B13	GND	A13	N/C
B14	SATA_TX1-	A14	N/C
B15	SATA_TX1+	A15	GND
B16	GND	A16	SATA_RX1-
B17	+V5S	A17	SATA RX1+
B18	GND	A18	GND

Table 5-14: SATA 6Gb/s Connector (PCIEX1_SLOT1) Pinouts

5.2.14 SPI Flash Connector (JSPI1)

PIN NO.	DESCRIPTION
1	+3.3V
2	SPI_CS
3	SPI_SO
4	SPI_CLK
5	SPI_SI
6	GND

Table 5-15: SPI Flash Connector (JSPI1) Pinouts

5.2.15 SPI Flash Connector - EC (JSPI2)

PIN NO.	DESCRIPTION
1	+3.3V
2	SPI_CS#0_CN_EC
3	SPI_SO_SW_EC
4	SPI_CLK_SW_EC
5	SPI_SI_SW_EC
6	GND

Table 5-16: SPI Flash Connector - EC (JSPI2) Pinouts

PUZZLE-IN001

5.2.16 TPM Connector (TPM1)

PIN NO.	DESCRIPTION	PIN NO.	DESCRIPTION
1	LCLK	2	GND
3	LFRAME#	4	KEY
5	LRERST#	6	+5V
7	LAD3	8	LAD2
9	+3.3V	10	LAD1
11	LAD0	12	GND
13	SCL	14	SDA
15	SB3V	16	SERIRQ
17	GND	18	GLKRUN#
19	LPCPD#	20	LDRQ#

Table 5-17: TPM Connector (TPM1) Pinouts

5.2.17 USB 2.0 Connector (USB1)

PIN NO.	DESCRIPTION	PIN NO.	DESCRIPTION
1	VCC	2	GND
3	USB_DATA-	4	USB_DATA+
5	USB_DATA+	6	USB_DATA-
7	GND	8	VCC

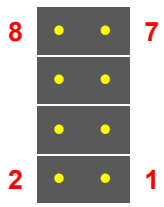

Table 5-18: USB 2.0 Connector (USB1) Pinouts

5.2.18 IEI Networking Module Slot A

PIN NO.	DESCRIPTION	PIN NO.	DESCRIPTION
B1	+12v	A1	NC
B2	+12v	A2	+12v
B3	+12v	A3	+12v
B4	GND	A4	GND
B5	SMCLK	A5	NC
B6	SMDAT	A6	NC
B7	GND	A7	NC
B8	+3.3v	A8	NC
B9	NC	A9	+3.3v
B10	3.3Vaux	A10	+3.3v
B11	WAKE#	A11	PWRGD
B12	NC	A12	GND
B13	GND	A13	REFCLK+
B14	HSOp(0)	A14	REFCLK-
B15	HSOn(0)	A15	GND
B16	GND	A16	HSIp(0)
B17	RLYCTL1*	A17	HSIn(0)
B18	GND	A18	GND
B19	HSOp(1)	A19	LANID1**
B20	HSOn(1)	A20	GND
B21	GND	A21	HSIp(1)
B22	GND	A22	HSIn(1)
B23	HSOp(2)	A23	GND
B24	HSOn(2)	A24	GND
B25	GND	A25	HSIp(2)
B26	GND	A26	HSIn(2)
B27	HSOp(3)	A27	GND
B28	HSOn(3)	A28	GND
B29	GND	A29	HSIp(3)
B30	RLYCTL2*	A30	HSIn(3)

PUZZLE-IN001

B31	NC	A31	GND
B32	GND	A32	LANID2**
B33	HSOp(4)	A33	NC
B34	HSOn(4)	A34	GND
B35	GND	A35	HSIp(4)
B36	GND	A36	HSIn(4)
B37	HSOp(5)	A37	GND
B38	HSOn(5)	A38	GND
B39	GND	A39	HSIp(5)
B40	GND	A40	HSIn(5)
B41	HSOp(6)	A41	GND
B42	HSOn(6)	A42	GND
B43	GND	A43	HSIp(6)
B44	GND	A44	HSIn(6)
B45	HSOp(7)	A45	GND
B46	HSOn(7)	A46	GND
B47	GND	A47	HSIp(7)
B48	NC	A48	HSIn(7)
B49	GND	A49	GND

*PIN B17 & B30 is assigned to Relay control signal; it is only active when inserting a specific LAN module that supports LAN bypass function.

PIN A19 & A32 is identification of PCIe Link configuration. See **Table 5-21 for PCIe Link configuration.

Table 5-19: IEI Networking Module Slot A Pinouts

5.2.19 IEI Networking Module Slot B

PIN NO.	DESCRIPTION	PIN NO.	DESCRIPTION
B1	+12v	A1	NC
B2	+12v	A2	+12v
B3	+12v	A3	+12v
B4	GND	A4	GND
B5	SMCLK	A5	NC
B6	SMDAT	A6	NC
B7	GND	A7	NC
B8	+3.3v	A8	NC
B9	NC	A9	+3.3v
B10	3.3Vaux	A10	+3.3v
B11	WAKE#	A11	PWRGD
B12	NC	A12	GND
B13	GND	A13	REFCLK+
B14	HSOp(0)	A14	REFCLK-
B15	HSOn(0)	A15	GND
B16	GND	A16	HSIp(0)
B17	RLYCTL1*	A17	HSIn(0)
B18	GND	A18	GND
B19	HSOp(1)	A19	LANID1**
B20	HSOn(1)	A20	GND
B21	GND	A21	HSIp(1)
B22	GND	A22	HSIn(1)
B23	HSOp(2)	A23	GND
B24	HSOn(2)	A24	GND
B25	GND	A25	HSIp(2)
B26	GND	A26	HSIn(2)
B27	HSOp(3)	A27	GND
B28	HSOn(3)	A28	GND
B29	GND	A29	HSIp(3)
B30	RLYCTL2*	A30	HSIn(3)

PUZZLE-IN001

B31	NC	A31	GND
B32	GND	A32	LANID2**
B33	HSOp(4)	A33	NC
B34	HSOn(4)	A34	GND
B35	GND	A35	HSIp(4)
B36	GND	A36	HSIn(4)
B37	HSOp(5)	A37	GND
B38	HSOn(5)	A38	GND
B39	GND	A39	HSIp(5)
B40	GND	A40	HSIn(5)
B41	HSOp(6)	A41	GND
B42	HSOn(6)	A42	GND
B43	GND	A43	HSIp(6)
B44	GND	A44	HSIn(6)
B45	HSOp(7)	A45	GND
B46	HSOn(7)	A46	GND
B47	GND	A47	HSIp(7)
B48	NC	A48	HSIn(7)
B49	GND	A49	GND

*PIN B17 & B30 is assigned to Relay control signal; it is only active when inserting a specific LAN module that supports LAN bypass function.

PIN A19 & A32 is identification of PCIe Link configuration. See **Table 5-21 for PCIe Link configuration.

Table 5-20: IEI Networking Module Slot B Pinouts

A19	A32	PCIe Config.
0	0	Four x2
0	1	Two x4
1	0	One x8

Table 5-21: PCIe Link Configuration

Appendix

A

Regulatory Compliance

DECLARATION OF CONFORMITY



This equipment is in conformity with the following EU directives:

- EMC Directive 2014/30/EU
- Low-Voltage Directive 2014/35/EU
- RoHS II Directive 2011/65/EU

If the user modifies and/or install other devices in the equipment, the CE conformity declaration may no longer apply.

If this equipment has telecommunications functionality, it also complies with the requirements of the R&TTE Directive 1999/5/EC.

English

IEI Integration Corp declares that this equipment is in compliance with the essential requirements and other relevant provisions of Directive 1999/5/EC.

Български [Bulgarian]

IEI Corp. декларира, че този оборудване е в съответствие със съществените изисквания и другите приложими правила на Директива 1999/5/EC.

Česky [Czech]

IEI prohlašuje, že tento zařzení je ve shodě se základními požadavky a dalšími příslušnými směrnice 1999/5/ES.

Deutsch [German]

IEI Integration Corp, erklärt dieses Gerät entspricht den grundlegenden Anforderungen und den weiteren entsprechenden Vorgaben der Richtlinie 1999/5/EU.

Eesti [Estonian]

IEI Integration Corp deklareerib seadme vastavust direktiivi 1999/5/EÜ põhinõuetele ja nimetatud direktiivist tulenevatele teistele asjakohastele sätetele.

Español [Spanish]

IEI Integration Corp declara que el equipo cumple con los requisitos esenciales y cualesquiera otras disposiciones aplicables o exigibles de la Directiva 1999/5/CE.

Ελληνική [Greek]

IEI Integration Corp ΔΗΛΩΝΕΙ ΟΤΙ ΕΞΟΠΛΙΣΜΟΣ ΣΥΜΜΟΡΦΩΝΕΤΑΙ ΠΡΟΣ ΤΙΣ ΟΥΣΙΩΔΕΙΣ ΑΠΑΙΤΗΣΕΙΣ ΚΑΙ ΤΙΣ ΛΟΙΠΕΣ ΣΧΕΤΙΚΕΣ ΔΙΑΤΑΞΕΙΣ ΤΗΣ ΟΔΗΓΙΑΣ 1999/5/ΕΚ.

Français [French]

IEI Integration Corp déclare que l'appareil est conforme aux exigences essentielles et aux autres dispositions pertinentes de la directive 1999/5/CE.

Italiano [Italian]

IEI Integration Corp dichiara che questo apparecchio è conforme ai requisiti essenziali ed alle altre disposizioni pertinenti stabilite dalla direttiva 1999/5/CE.

Latviski [Latvian]

IEI Integration Corp deklarē, ka iekārta atbilst būtiskajām prasībām un citiem ar to saistītajiem noteikumiem Direktīvas 1999/5/ΕΚ.

Lietuvių [Lithuanian]

IEI Integration Corp deklaruoja, kad šis įranga atitinka esminius reikalavimus ir kitas 1999/5/EB Direktyvos nuostatas.

Nederlands [Dutch]

IEI Integration Corp dat het toestel toestel in overeenstemming is met de essentiële eisen en de andere relevante bepalingen van richtlijn 1999/5/EG.

Malti [Maltese]

IEI Integration Corp jiddikjara li dan prodott jikkonforma mal-ħtiġijiet essenzjali u ma provvedimenti oħrajn relevanti li hemm fid-Dirrettiva 1999/5/EC.

Magyar [Hungarian]

IEI Integration Corp nyilatkozom, hogy a berendezés megfelel a vonatkozó alapvető követelményeknek és az 1999/5/EC irányelv egyéb előírásainak.

Polski [Polish]

IEI Integration Corp oświadcza, że wyrobu jest zgodny z zasadniczymi wymogami oraz pozostałymi stosownymi postanowieniami Dyrektywy 1999/5/EC.

Português [Portuguese]

IEI Integration Corp declara que este equipamento está conforme com os requisitos essenciais e outras disposições da Directiva 1999/5/CE.

Româna [Romanian]

IEI Integration Corp declară că acest echipament este în conformitate cu cerințele esențiale și cu celelalte prevederi relevante ale Directivei 1999/5/CE.

PUZZLE-IN001

Slovensko [Slovenian]

IEI Integration Corp izjavlja, da je ta opreme v skladu z bistvenimi zahtevami in ostalimi relevantnimi določili direktive 1999/5/ES.

Slovensky [Slovak]

IEI Integration Corp týmto vyhlasuje, že zariadenia spĺňa základné požiadavky a všetky príslušné ustanovenia Smernice 1999/5/ES.

Suomi [Finnish]

IEI Integration Corp vakuuttaa täten että laitteet on direktiivin 1999/5/EY oleellisten vaatimusten ja sitä koskevien direktiivin muiden ehtojen mukainen.

Svenska [Swedish]

IEI Integration Corp förklarar att denna utrustningstyp står i överensstämmelse med de väsentliga egenskapskrav och övriga relevanta bestämmelser som framgår av direktiv 1999/5/EG.

FCC WARNING

This equipment complies with Part 15 of the FCC Rules. Operation is subject to the following two conditions:

- This device may not cause harmful interference, and
- This device must accept any interference received, including interference that may cause undesired operation.

This equipment has been tested and found to comply with the limits for a Class A digital device, pursuant to part 15 of the FCC Rules. These limits are designed to provide reasonable protection against harmful interference when the equipment is operated in a commercial environment. This equipment generates, uses, and can radiate radio frequency energy and, if not installed and used in accordance with the instruction manual, may cause harmful interference to radio communications. Operation of this equipment in a residential area is likely to cause harmful interference in which case the user will be required to correct the interference at his own expense.

ROHS STATEMENT

The label on the product indicates this product conforms to European (EU) Restriction of Hazardous Substances (RoHS) that set maximum concentration limits on hazardous materials used in electrical and electronic equipment.

CHINA ROHS

The label on the product indicates the estimated “Environmentally Friendly Use Period” (EFUP). This is an estimate of the number of years that these substances would “not leak out or undergo abrupt change.” This product may contain replaceable sub-assemblies/components which have a shorter EFUP such as batteries and lamps. These components will be separately marked.

Appendix

B

Safety Precautions

B.1 Safety Precautions



WARNING:

The precautions outlined in this appendix should be strictly followed. Failure to follow these precautions may result in permanent damage to the PUZZLE-IN001.

Please follow the safety precautions outlined in the sections that follow:

B.1.1 General Safety Precautions

Please ensure the following safety precautions are adhered to at all times.

- ***Make sure the power is turned off and the power cord is disconnected*** when moving, installing or modifying the system.
- ***Do not apply voltage levels that exceed the specified voltage range.*** Doing so may cause fire and/or an electrical shock.
- ***Electric shocks can occur*** if opened while still powered on.
- ***Do not drop or insert any objects*** into the ventilation openings.
- ***If considerable amounts of dust, water, or fluids enter the system***, turn off the power supply immediately, unplug the power cord, and contact the system vendor.
- **DO NOT:**
 - Drop the system against a hard surface.
 - In a site where the ambient temperature exceeds the rated temperature

PUZZLE-IN001

B.1.2 Anti-static Precautions



WARNING:

Failure to take ESD precautions during the installation of the PUZZLE-IN001 may result in permanent damage to the PUZZLE-IN001 and severe injury to the user.

Electrostatic discharge (ESD) can cause serious damage to electronic components, including the PUZZLE-IN001. Dry climates are especially susceptible to ESD. It is therefore critical that whenever the PUZZLE-IN001 is opened and any of the electrical components are handled, the following anti-static precautions are strictly adhered to.

- ***Wear an anti-static wristband:*** Wearing a simple anti-static wristband can help to prevent ESD from damaging any electrical component.
- ***Self-grounding:*** Before handling any electrical component, touch any grounded conducting material. During the time the electrical component is handled, frequently touch any conducting materials that are connected to the ground.
- ***Use an anti-static pad:*** When configuring or working with an electrical component, place it on an anti-static pad. This reduces the possibility of ESD damage.
- ***Only handle the edges of the electrical component:*** When handling the electrical component, hold the electrical component by its edges.

B.1.3 Product Disposal

**CAUTION:**

Risk of explosion if the battery is replaced by an incorrect type;

Replacement of a battery with an incorrect type that can defeat a safeguard (for example, in the case of some lithium battery types);

Disposal of a battery into fire or a hot oven, or mechanically crushing or cutting of a battery, that can result in an explosion;

Leaving a battery in an extremely high temperature surrounding environment that can result in an explosion or the leakage of flammable liquid or gas;

A battery subjected to extremely low air pressure that may result in an explosion or the leakage of flammable liquid or gas.

Dispose of used batteries according to instructions and local regulations.

- Outside the European Union - If you wish to dispose of used electrical and electronic products outside the European Union, please contact your local authority so as to comply with the correct disposal method.
- Within the European Union:

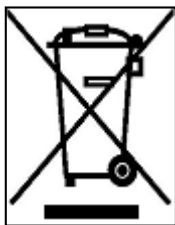

EU-wide legislation, as implemented in each Member State, requires that waste electrical and electronic products carrying the mark (left) must be disposed of separately from normal household waste. This includes monitors and electrical accessories, such as signal cables or power cords. When you need to dispose of your display products, please follow the guidance of your local authority, or ask the shop where you purchased the product. The mark on electrical and electronic products only applies to the current European Union Member States.

Please follow the national guidelines for electrical and electronic product disposal.

PUZZLE-IN001

B.2 Maintenance and Cleaning Precautions

When maintaining or cleaning the PUZZLE-IN001, please follow the guidelines below.

B.2.1 Maintenance and Cleaning

Prior to cleaning any part or component of the PUZZLE-IN001, please read the details below.

- The interior of the PUZZLE-IN001 does not require cleaning. Keep fluids away from the PUZZLE-IN001 interior.
- Be cautious of all small removable components when vacuuming the PUZZLE-IN001.
- Turn the PUZZLE-IN001 off before cleaning the PUZZLE-IN001.
- Never drop any objects or liquids through the openings of the PUZZLE-IN001.
- Be cautious of any possible allergic reactions to solvents or chemicals used when cleaning the PUZZLE-IN001.
- Avoid eating, drinking and smoking within vicinity of the PUZZLE-IN001.

B.2.2 Cleaning Tools

Some components in the PUZZLE-IN001 may only be cleaned using a product specifically designed for the purpose. In such case, the product will be explicitly mentioned in the cleaning tips. Below is a list of items to use when cleaning the PUZZLE-IN001.

- **Cloth** – Although paper towels or tissues can be used, a soft, clean piece of cloth is recommended when cleaning the PUZZLE-IN001.
- **Water or rubbing alcohol** – A cloth moistened with water or rubbing alcohol can be used to clean the PUZZLE-IN001.
- **Using solvents** – The use of solvents is not recommended when cleaning the PUZZLE-IN001 as they may damage the plastic parts.
- **Vacuum cleaner** – Using a vacuum specifically designed for computers is one of the best methods of cleaning the PUZZLE-IN001. Dust and dirt can restrict the airflow in the PUZZLE-IN001 and cause its circuitry to corrode.
- **Swabs** - Swabs moistened with rubbing alcohol or water are excellent tools for wiping hard to reach areas. Whenever possible, it is best to use lint free swabs such as foam swabs for cleaning.

Appendix

C

Error Beep Code

C.1 PEI Beep Codes

Number of Beeps	Description
1	Memory not Installed
1	Memory was installed twice (InstallPeiMemory routine in PEI Core called twice)
2	Recovery started
3	DXE IPL was not found
3	DXE Core Firmware Volume was not found
4	Recovery failed
4	S3 Resume failed
7	Reset PPI is not available

C.2 DXE Beep Codes

Number of Beeps	Description
1	Invalid password
4	Some of the Architectural Protocols are not available
5	No Console Output Devices are found
5	No Console Input Devices are found
6	Flash update is failed
7	Reset protocol is not available
8	Platform PCI resource requirements cannot be met



NOTE:

If you have any question, please contact IEI for further assistance.

Appendix

D

Hazardous Materials Disclosure

D.1 RoHS II Directive (2015/863/EU)

The details provided in this appendix are to ensure that the product is compliant with the RoHS II Directive (2015/863/EU). The table below acknowledges the presences of small quantities of certain substances in the product, and is applicable to RoHS II Directive (2015/863/EU).

Please refer to the following table.

Part Name	Toxic or Hazardous Substances and Elements									
	Lead (Pb)	Mercury (Hg)	Cadmium (Cd)	Hexavalent Chromium (CR(VI))	Polybrominated Biphenyls (PBB)	Polybrominated Diphenyl Ethers (PBDE)	Bis(2-ethylhexyl) phthalate (DEHP)	Butyl benzyl phthalate (BBP)	Dibutyl phthalate (DBP)	Diisobutyl phthalate (DIBP)
Housing	O	O	O	O	O	O	O	O	O	O
Display	O	O	O	O	O	O	O	O	O	O
Printed Circuit Board	O	O	O	O	O	O	O	O	O	O
Metal Fasteners	O	O	O	O	O	O	O	O	O	O
Cable Assembly	O	O	O	O	O	O	O	O	O	O
Fan Assembly	O	O	O	O	O	O	O	O	O	O
Power Supply Assemblies	O	O	O	O	O	O	O	O	O	O
Battery	O	O	O	O	O	O	O	O	O	O

O: This toxic or hazardous substance is contained in all of the homogeneous materials for the part is below the limit requirement in Directive (EU) 2015/863.

X: This toxic or hazardous substance is contained in at least one of the homogeneous materials for this part is above the limit requirement in Directive (EU) 2015/863.

PUZZLE-IN001

D.2 China RoHS

此附件旨在确保本产品符合中国 RoHS 标准。以下表格标示此产品中某有毒物质的含量符合中国 RoHS 标准规定的限量要求。

本产品上会附有“环境友好使用期限”的标签，此期限是估算这些物质“不会有泄漏或突变”的年限。本产品可能包含有较短的环境友好使用期限的可替换元件，像是电池或灯管，这些元件将会单独标示出来。

部件名称	有毒有害物质或元素					
	铅 (Pb)	汞 (Hg)	镉 (Cd)	六价铬 (Cr(VI))	多溴联苯 (PBB)	多溴二苯醚 (PBDE)
壳体	○	○	○	○	○	○
显示	○	○	○	○	○	○
印刷电路板	○	○	○	○	○	○
金属螺帽	○	○	○	○	○	○
电缆组装	○	○	○	○	○	○
风扇组装	○	○	○	○	○	○
电力供应组装	○	○	○	○	○	○
电池	○	○	○	○	○	○

○: 表示该有毒有害物质在该部件所有物质材料中的含量均在 SJ/T11364-2014 與 GB/T26572-2011 标准规定的限量要求以下。

X: 表示该有毒有害物质至少在该部件的某一均质材料中的含量超出 SJ/T11364-2014 與 GB/T26572-2011 标准规定的限量要求。