



MODEL:

TANK-630-EHL Series

Fanless embedded system with Intel® Celeron® J6412 2.0GHz (up to 2.6GHz, 4-Core, TDP 10W), 8GB DDR4 pre-installed memory, 10V~28V DC, with RS-232, RS-232/422/485, USB 3.2, USB 2.0, HDMI, 2.5GbE LAN and RoHS

User Manual

Revision

Date	Version	Changes
Nov. 13, 2023	1.00	Initial release
June 24, 2024	1.01	Added DEVICE MODE option description for serial port 7 and serial port 8
August 1, 2024	1.02	Corrected system board COM port connector identification number and upgraded OS image version to R11

Copyright

COPYRIGHT NOTICE

The information in this document is subject to change without prior notice in order to improve reliability, design and function and does not represent a commitment on the part of the manufacturer.

In no event will the manufacturer be liable for direct, indirect, special, incidental, or consequential damages arising out of the use or inability to use the product or documentation, even if advised of the possibility of such damages.

This document contains proprietary information protected by copyright. All rights are reserved. No part of this manual may be reproduced by any mechanical, electronic, or other means in any form without prior written permission of the manufacturer.

TRADEMARKS

All registered trademarks and product names mentioned herein are used for identification purposes only and may be trademarks and/or registered trademarks of their respective owners.

Manual Conventions



WARNING

Warnings appear where overlooked details may cause damage to the equipment or result in personal injury. Warnings should be taken seriously.



CAUTION

Cautionary messages should be heeded to help reduce the chance of losing data or damaging the product.



NOTE

These messages inform the reader of essential but non-critical information. These messages should be read carefully as any directions or instructions contained therein can help avoid making mistakes.



HOT SURFACE

This symbol indicates a hot surface that should not be touched without taking care.

Table of Content

1 INTRODUCTION.....	1
1.1 OVERVIEW.....	2
1.2 FEATURES.....	2
1.3 TECHNICAL SPECIFICATIONS	3
1.4 FRONT PANEL.....	5
1.5 REAR PANEL.....	6
1.6 PHYSICAL DIMENSIONS	7
2 UNPACKING	8
2.1 ANTI-STATIC PRECAUTIONS	9
2.2 UNPACKING PRECAUTIONS.....	9
2.3 PACKING LIST.....	10
2.4 OPTIONAL ITEMS	11
3 INSTALLATION	12
3.1 INSTALLATION PRECAUTIONS	13
3.2 HARD DISK DRIVE (HDD) INSTALLATION.....	14
3.3 WIRELESS LAN MODULE INSTALLATION (OPTIONAL).....	16
3.4 MOUNTING THE SYSTEM	19
3.4.1 <i>Mounting with Mounting Brackets (Optional)</i>	19
3.4.2 <i>DIN rail Mount Kit Installation (Optional)</i>	19
3.5 AT/ATX MODE SELECTION	21
3.5.1 <i>AT Power Mode</i>	21
3.5.2 <i>ATX Power Mode</i>	22
3.6 EXTERNAL PERIPHERAL MAIN INTERFACE CONNECTORS.....	23
3.6.1 <i>HDMI Connector</i>	23
3.6.2 <i>LAN Connectors</i>	23
3.6.3 <i>DB9 Serial Port Connectors</i>	25
3.6.4 <i>USB Connectors</i>	25
3.6.5 <i>DIO Connector</i>	26

3.7 POWERING ON/OFF THE SYSTEM	27
3.8 RESET THE SYSTEM	28
3.9 AVAILABLE DRIVERS	29
3.9.1 Driver Download	29
4 SYSTEM MOTHERBOARD	31
4.1 OVERVIEW.....	32
4.2 LAYOUT.....	32
4.3 EXTERNAL INTERFACE CONNECTORS	33
4.3.1 AT//ATX Power Mode Setting	34
4.3.2 Reset Button Mode Setting	35
4.4 INTERNAL INTERFACE CONNECTORS	35
4.4.1 Clear CMOS Button Connector	36
4.4.2 DNX Mode Setting Jumper	38
4.4.3 Flash Descriptor Override Setting Jumper.....	39
4.4.4 RTC Battery Connector.....	40
4.4.5 DDR4 SO-DIMM Socket.....	41
4.4.6 Mini SATA Connector.....	43
4.4.7 Flash SPI ROM Connector	44
4.4.8 Flash EC ROM Connector.....	45
4.4.9 I ² C Connector	46
4.4.10 Internal USB 2.0 Connectors.....	47
4.4.11 HDD LED Connector.....	48
4.4.12 SPI TPM Connector	49
4.4.13 Digital Input / Output Connector.....	50
4.4.14 Case Open Circuit Setting.....	52
4.4.15 M.2 A-key Slot.....	53
4.4.16 M.2 B-key Slot.....	55
4.4.17 M.2 M-key Slot.....	57
5 BIOS	60
5.1 INTRODUCTION.....	61
5.1.1 Starting Setup.....	61
5.1.2 Using Setup	62
5.1.2.1 Keyboard Navigation	62

TANK-630-EHL

5.1.2.2 Touch Navigation	63
5.1.3 Getting Help	64
5.1.4 Unable to Reboot after Configuration Changes	64
5.1.5 BIOS Menu Bar	64
5.2 MAIN	65
5.3 ADVANCED	68
5.3.1 CPU Configuration	69
5.3.2 Trusted Computing	73
5.3.3 RTC Wake Settings	75
5.3.4 F81966 Super IO Configuration	77
5.3.4.1 Serial Port 3 Configuration	78
5.3.4.2 Serial Port 4 Configuration	79
5.3.4.3 Serial Port 5 Configuration	80
5.3.4.4 Serial Port 6 Configuration	81
5.3.4.5 Serial Port 7 Configuration	82
5.3.4.6 Serial Port 8 Configuration	83
5.3.5 IT5571SEC Super IO Configuration	85
5.3.5.1 Serial Port 1 Configuration	85
5.3.5.2 Serial Port 2 Configuration	86
5.3.6 IT5571 H/W Monitor	87
5.3.7 Serial Port Console Redirection	88
5.3.7.1 Console Redirection Settings	88
5.3.8 NVMe Configuration	91
5.4 CHIPSET	92
5.4.1 System Agent (SA) Configuration	92
5.4.1.1 Memory Configuration	94
5.4.1.2 Graphics Configuration	95
5.4.2 PCH-IO Configuration	96
5.4.2.1 PCI Express Configuration	98
5.4.2.2 PCI Express Root Port Setting	99
5.4.2.3 SATA Configuration	101
5.4.2.4 HD Audio Configuration	102
5.5 SECURITY	103
5.6 BOOT	104
5.6.1 Boot Configuration	104

5.6.2 *Boot Option Priorities*..... 105

5.7 **SAVE & EXIT** 106

A.1 **SAFETY PRECAUTIONS** 109

A.1.1 General Safety Precautions 109

A.1.2 Anti-static Precautions 110

List of Figures

Figure 1-1: TANK-630-EHL Series	2
Figure 1-2: Front Panel	5
Figure 1-3: Rear Panel.....	6
Figure 1-4: Physical Dimensions	7
Figure 3-1: Remove Retention Screws (Bottom Panel)	14
Figure 3-2: HDD Bracket Retention Screws	14
Figure 3-3: Inserting HDD	15
Figure 3-4: Reinstall the bottom cover	15
Figure 3-5: Knockout Holes for Wireless Antenna.....	16
Figure 3-6: M.2 A-key Location	16
Figure 3-7: Removing the Retention Screw	17
Figure 3-8: Inserting the WLAN Module	17
Figure 3-9: Securing WLAN Module and Connecting RF Cables	18
Figure 3-10: Securing SMA Connector and External Antenna Installation	18
Figure 3-11: Mounting Bracket Retention Screw	19
Figure 3-12: DIN Rail Mounting Bracket Installation.....	20
Figure 3-13: Attach the Mounting Bracket to the DIN Rail	20
Figure 3-14: Mounting the System.....	21
Figure 3-15: AT/ATX Switch Location.....	21
Figure 3-16: HDMI Connection	23
Figure 3-17: LAN Connection	24
Figure 3-18: RJ-45 Ethernet Connector	24
Figure 3-19: USB Connection.....	26
Figure 3-20: Power Button	27
Figure 3-21: Reset Button Location.....	28
Figure 4-1: System Motherboard (Front).....	32
Figure 4-2: System Motherboard (Rear).....	33
Figure 4-3: AT/ATX Power Mode Switch Locations	34
Figure 4-4: Reset Button Location.....	35
Figure 4-5: Clear CMOS Location	37

Figure 4-6: DNX Mode Setting Jumper Location	38
Figure 4-7: Flash Descriptor Override Setting Jumper Locations	39
Figure 4-8: Battery Connector Location.....	41
Figure 4-9: DDR4 SO-DIMM Connectors Location	42
Figure 4-10: Mini SATA Connectors Location	43
Figure 4-11: Flash SPI ROM Connector Location	44
Figure 4-12: Flash EC ROM Connector Location	46
Figure 4-13: I ² C Connector Location	46
Figure 4-14: Internal USB 2.0 Connectors Locations	47
Figure 4-15: HDD LED Connector Location	48
Figure 4-16: SPI TPM Connectors Location.....	49
Figure 4-17: Digital I/O Connector Location	51
Figure 4-18: Case Open Circuit Setting Location.....	52
Figure 4-19: M.2 A-key Slot Location.....	53
Figure 4-20: M.2 B-key Slot Location.....	55
Figure 4-21: M.2 M-key Slot Location	57
Figure 5-1: BIOS Starting Menu	61
Figure 5-2: BIOS Navigation Keys	62
Figure 5-3: BIOS On-screen Navigation Keys	63
Figure 5-4: BIOS Options and Configured LAN_USB Ports.....	97

List of Tables

Table 1-1: Technical Specifications	4
Table 2-1: Optional Items	11
Table 3-1: LAN1-3 2.5GbE RJ-45 Ethernet Connector LEDs	24
Table 3-2: Serial Ports Connector Pinouts	25
Table 3-3: Digital IO Connector Pinouts	26
Table 4-1: Peripheral Interface Connectors	34
Table 4-2: AT/ATX Power Mode Switch Pinouts	34
Table 4-3: Reset Button Pinouts	35
Table 4-4: Peripheral Interface Connectors	36
Table 4-5: Clear CMOS Pinouts	37
Table 4-6: DNX Mode setting Jumper Pinouts	38
Table 4-7: Flash Descriptor Override Setting Jumper Pinouts	39
Table 4-8: Battery Connector Pinouts	41
Table 4-9: SATA 6Gb/s Drive Connectors Pinouts	44
Table 4-10: Flash SPI ROM Connector Pinouts	45
Table 4-11: Flash EC ROM Connector Pinouts	46
Table 4-12: I ² C Connector Pinouts	47
Table 4-13: Internal USB 2.0 Connectors Pinouts	48
Table 4-14: HDD LED Connector Pinouts	49
Table 4-15: SPI TPM Connector (TPM1) Pinouts	50
Table 4-16: Digital I/O Connector Pinouts	51
Table 4-17: Case Open Circuit Setting Location Pinouts	52
Table 4-18: M.2 A-Key Slot Pinouts	55
Table 4-19: M.2 B-Key Slot Pinouts	57
Table 4-20: M.2 M-key Slot Pinouts	59

BIOS Menus

BIOS Menu 1: Main (1/2).....	65
BIOS Menu 2: Main (2/2).....	65
BIOS Menu 3: Advanced	68
BIOS Menu 4: CPU Configuration (1/3).....	69
BIOS Menu 5: CPU Configuration (2/3).....	69
BIOS Menu 6: CPU Configuration (3/3).....	70
BIOS Menu 7: Trusted Computing	73
BIOS Menu 8: RTC Wake Settings (1/2).....	75
BIOS Menu 9: RTC Wake Settings (2/2).....	75
BIOS Menu 10: F81966 Super IO Configuration	77
BIOS Menu 11: Serial Port 3 Configuration Menu	78
BIOS Menu 12: Serial Port 4 Configuration Menu	79
BIOS Menu 13: Serial Port 5 Configuration Menu	80
BIOS Menu 14: Serial Port 6 Configuration Menu	81
BIOS Menu 15: Serial Port 7 Configuration Menu	82
BIOS Menu 16: Serial Port 8 Configuration Menu	83
BIOS Menu 17: IT5571 Super IO Configuration	85
BIOS Menu 18: Serial Port 1 Configuration Menu	85
BIOS Menu 19: Serial Port 2 Configuration Menu	86
BIOS Menu 20: IT5571 H/W Monitor.....	87
BIOS Menu 21: Serial Port Console Redirection	88
BIOS Menu 22: COM Console Redirection Settings	89
BIOS Menu 23: NVMe configuration	91
BIOS Menu 24: Chipset	92
BIOS Menu 25: System Agent (SA) Configuration	93
BIOS Menu 26: Memory Configuration.....	94
BIOS Menu 27: Graphics Configuration	95
BIOS Menu 28: PCH-IO Configuration	96
BIOS Menu 29: PCI Express Configuration	98
BIOS Menu 30: PCIe Slot Configuration Submenu (1/2).....	99

TANK-630-EHL

BIOS Menu 31: PCIe Slot Configuration Submenu (2/2)	99
BIOS Menu 32: SATA Configuration	101
BIOS Menu 33: HD Audio Configuration	102
BIOS Menu 34: Security	103
BIOS Menu 35: Boot	104
BIOS Menu 36: Save & Exit	106

Chapter

1

Introduction

1.1 Overview



Figure 1-1: TANK-630-EHL Series

The TANK-630-EHL Series is a fanless embedded system for wide range temperature environments. It is powered by the Intel® Celeron® J6412 processor and supports two 204-pin DDR4 SO-DIMMs, 8GB pre-installed (up to 32GB). The TANK-630-EHL Series supports two independent display with HDMI ports. The TANK-630-EHL Series has three 2.5GbE LAN ports, two USB 3.2 ports, four USB 2.0 ports, six RS-232 connectors via DB-9 and two RS-232/422/485 connectors via DB-9.

1.2 Features

The TANK-630-EHL Series features are listed below:

- Intel® Celeron® J6412 processor
- Multiple COM ports: six RS-232 and two RS-232/422/485
- Two HDMI independent display ports
- Three M.2 and one 2.5" SATA storage device
- Wide range temperature

TANK-630-EHL

1.3 Technical Specifications

The TANK-630-EHL Series technical specifications listed in (Table 1-1)

Specifications		TANK-630-EHL
Chassis	Color	Black C
	Dimension (WxDxH) (mm)	184 x 200 x 53
	System Fan	Fanless
	Chassis Construction	Extruded aluminum alloy
Processor	CPU	Intel® Celeron® J6412 2.0GHz (up to 2.6GHz, quad-core, TDP 10W)
	Chipset	SoC
Memory	System Memory	2 x DDR4 3200MHz SO-DIMM (8GB pre-installed, up to 32GB)
Storage	HDD Drive	1 x 2.5" SATA 6Gb/s HDD/SSD Bay
I/O Interfaces	USB	2 x USB 3.2 Gen2 Type A
		4 x USB 2.0 Type A
	Ethernet	3 x 2.5 GbE by Intel® I225-V/I226-V controller
	Audio	1 x Line-out
		1 x Mic-in
	Wireless	1 x 802.11a/b/g/n/ac (M.2 A Key optional)
	Display	2 x HDMI (up to 4K@30Hz)
	Resolution	VGA: Up to 2560 x 1600
		HDMI: Up to 3840 x 2160
COM	6 x DB9 RS-232	
	2 x DB9 RS-232/422/485 with AFC	
TPM 2.0	1 x TPM (2 x10 pin)	
	Intel PTT	
Other	1 x Power Button	
	1 x Reset Button	
	1 x AT/ATX Switch	
	1 x Power LED (green)	
	1 x HDD LED (yellow)	
Expansions	M.2	1 x M.2 M-Key (2280 PCIe x2)
		1 x M.2 A-Key 2230(Pcie x1 & USB)

		1 x M.2 B-Key 2242/52/80 (SATA Only)
Power	Power Input	DC jack: 12 V~28 V DC Terminal Block: 12 ~ 28V DC
	Power Consumption	+12V@3.36A (Intel® Celeron® J6412 with 8GB memory)
Reliability	Mounting	Wall mount, VESA 100
	Operating Temperature	-20°C ~ 60°C with air flow (SSD), 10% ~ 95%, non-condensing
	Storage Temperature	-40°C ~ 80°C with air flow (SSD), 10% ~ 95%, non-condensing
	Operating Shock	Half-sine wave shock 5G, 11ms, 100 shocks per axis (SSD)
	Operation Vibration	MIL-STD-810G 514.6C-1 (SSD)
	Watchdog timer	Programmable 1~255 sec/min
	Weight (Net/Gross)	2.04 kg /2.29 kg
	Safety / EMC	CE, FCC, UKCA
OS	Supported OS	Microsoft® Windows® 10/11, Linux

Table 1-1: Technical Specifications

TANK-630-EHL

1.4 Front Panel

The front panel of the TANK-630-EHL Series has the following features (**Figure 1-2**):

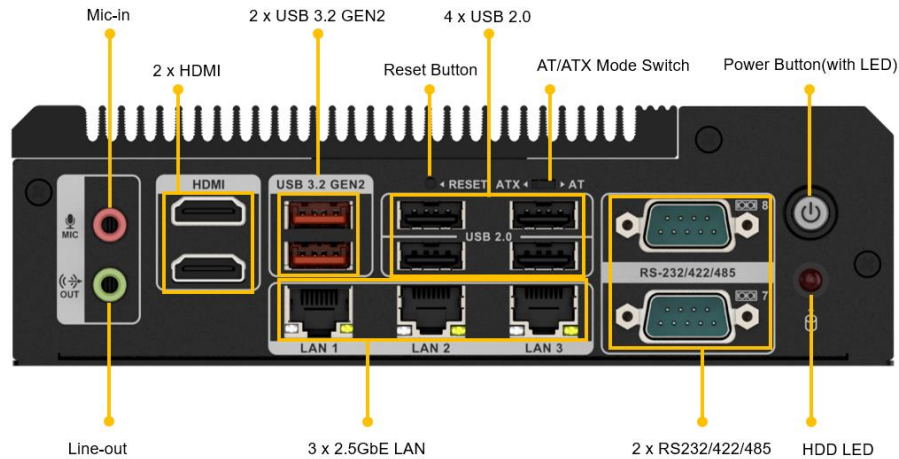

Figure 1-2: Front Panel

Connectors and buttons on the front panel include the following:

- 1 x AT/ATX mode switch
- 1 x HDD LED
- 2 x HDMI port
- 3 x LAN ports by RJ-45
- 1 x Line-out port (green)
- 1 x Mic-in port (pink)
- 1 x Power button
- 1 x Reset button
- 2 x RS-232/422/485 serial ports by DB-9
- 2 x USB 3.2 ports
- 4 x USB 2.0 ports

1.5 Rear Panel

The rear panel of the TANK-630-EHL Series is shown below (**Figure 1-3**):

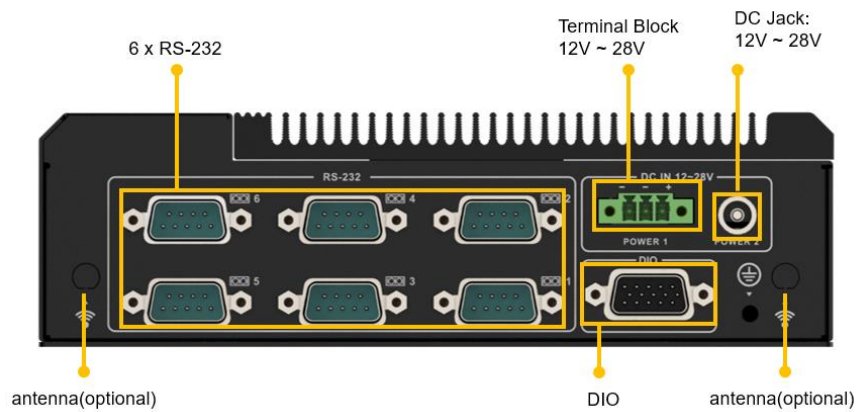

Figure 1-3: Rear Panel

Connectors and buttons on the front panel include the following:

- 1 x 12 V ~ 28 V DC Jack
- 1 x 12 V ~ 28 V Terminal Block
- 6 x RS-232 serial ports by DB-9
- 1 x DIO

TANK-630-EHL

1.6 Physical Dimensions

The physical dimensions of the TANK-630-EHL Series are shown in (Figure 1-4).

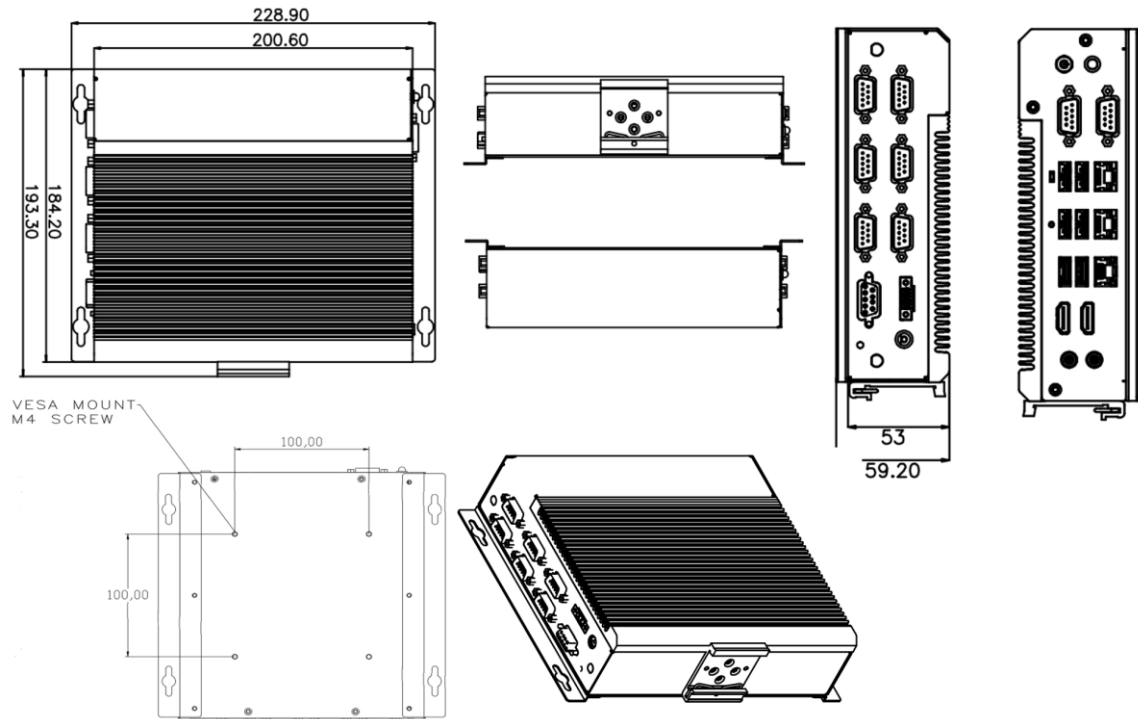

TANK-630-EHL

Figure 1-4: Physical Dimensions

Chapter

2

Unpacking

TANK-630-EHL

2.1 Anti-static Precautions



WARNING:

Failure to take ESD precautions during installation may result in permanent damage to the TANK-630-EHL Series and severe injury to the user.

Electrostatic discharge (ESD) can cause serious damage to electronic components, including the TANK-630-EHL Series. Dry climates are especially susceptible to ESD. It is therefore critical that whenever the TANK-630-EHL Series or any other electrical component is handled, the following anti-static precautions are strictly adhered to.

- **Wear an anti-static wristband:** Wearing a simple anti-static wristband can help to prevent ESD from damaging the board.
- **Self-grounding:** Before handling the board touch any grounded conducting material. During the time the board is handled, frequently touch any conducting materials that are connected to the ground.
- **Use an anti-static pad:** When configuring the TANK-630-EHL Series, place it on an anti-static pad. This reduces the possibility of ESD damaging the TANK-630-EHL Series.

2.2 Unpacking Precautions

When the TANK-630-EHL Series is unpacked, please do the following:



- Follow the anti-static precautions outlined in **Section 2.1**.
- Make sure the packing box is facing upwards that the TANK-630-EHL Series does not fall out of the box.
- Make sure all the components shown in **Section 2.2** are present.

2.3 Packing List

 **NOTE:**

If some of the components listed in the checklist below are missing, please do not proceed with the installation. Contact the IEI reseller or vendor you purchased the TANK-630-EHL Series from or contact an IEI sales representative directly. To contact an IEI sales representative, please send an email to sales@ieiworld.com.

The TANK-630-EHL Series is shipped with the following components:

Quantity	Item and Part Number	Image
Standard		
1	TANK-630-EHL Series	
1	Chassis screws	

TANK-630-EHL

2.4 Optional Items

The following are optional component(s) which may be separately purchased:

Optional	
Power Adapter (P/N: 63040-430084-000-RS)	
DIN-Rail mounting kit (P/N: 42311-0042E4-00-RS)	
Wall mounting kit (P/N: 41420-0581C2-00-HF *2)	
Power cord, European standard, 1830 mm (P/N: 32702-000202-100-RS)	
Wireless kit (P/N: EMB-WIFI-KIT02I3-R10)	
20-pin Infineon SPI TPM2.0 module (P/N: TPM-IN03-R10)	
OS Image with Windows® 10 Enterprise Entry 64-bit 2021 LTSC for TANK-630-EHL Series (P/N: TANK-630-EHL-W10IoT21-E-R11)	

Table 2-1: Optional Items

Chapter

3

Installation

TANK-630-EHL

3.1 Installation Precautions



WARNING:

The TANK-630-EHL Series has more than one power supply connection point.

To reduce the risk of electric shock, disconnect all power sources before installing or servicing the TANK-630-EHL Series.

During installation, be aware of the precautions below:

- **Read the user manual:** The user manual provides a complete description of the TANK-630-EHL Series, installation instructions and configuration options.
- **DANGER! Disconnect Power:** Power to the TANK-630-EHL Series must be disconnected during the installation process, or before any attempt is made to access the rear panel. Electric shock and personal injury might occur if the rear panel of the TANK-630-EHL Series is opened while the power cord is still connected to an electrical outlet.
- **Qualified Personnel:** The TANK-630-EHL Series must be installed and operated only by trained and qualified personnel. Maintenance, upgrades, or repairs may only be carried out by qualified personnel who are familiar with the associated dangers.
- **Air Circulation:** Make sure there is sufficient air circulation when installing the TANK-630-EHL Series. The TANK-630-EHL Series' cooling vents must not be obstructed by any objects. Blocking the vents can cause overheating of the TANK-630-EHL Series. Leave at least 5 cm of clearance around the TANK-630-EHL Series to prevent overheating.
- **Grounding:** The TANK-630-EHL Series should be properly grounded. The voltage feeds must not be overloaded. Adjust the cabling and provide external overcharge protection per the electrical values indicated on the label attached to the back of the TANK-630-EHL Series.

3.2 Hard Disk Drive (HDD) Installation

To install the hard drive, please follow the steps below:

Step 1: Remove eight retention screws from the bottom panel, as shown in **Figure 3-1**.



Figure 3-1: Remove Retention Screws (Bottom Panel)

Step 2: Remove the bottom cover from the device and turn it over. Remove the HDD brackets by removing the four screws (**Figure 3-2**)

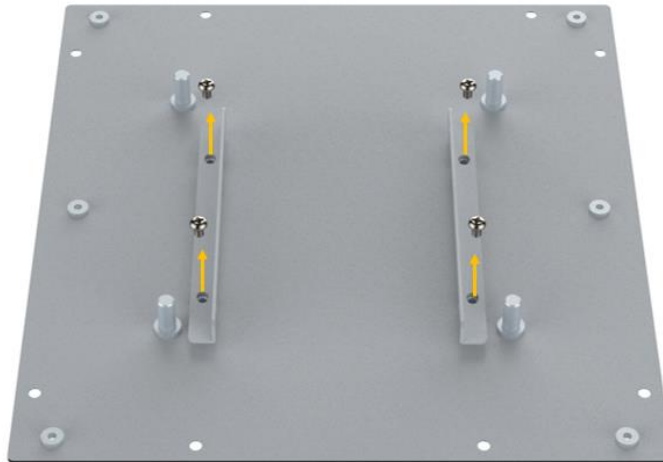

Figure 3-2: HDD Bracket Retention Screws

Step 1: Attach the HDD brackets to the sides of the HDD, and secure the brackets to the HDD by using four retention screws, then connect the HDD cable (**Figure 3-3**).

TANK-630-EHL

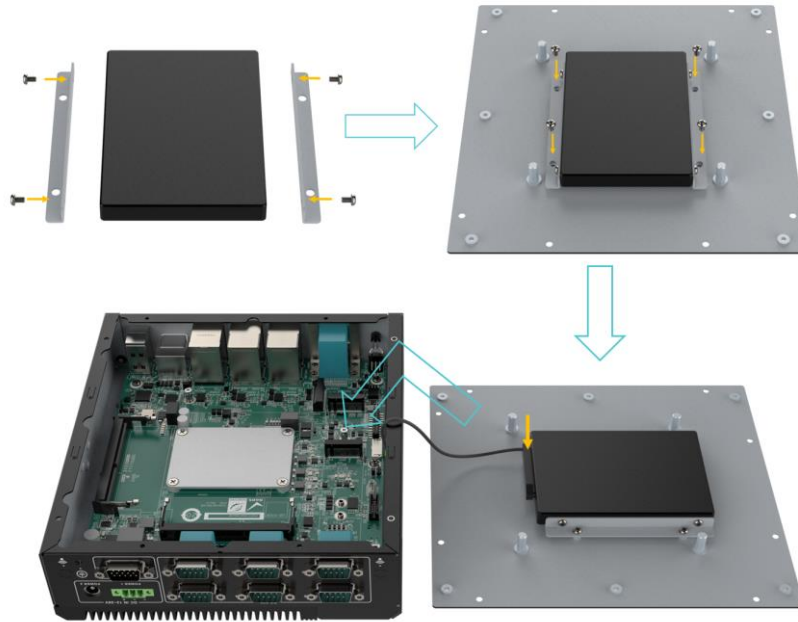

Figure 3-3: Inserting HDD

Step 2: Reinstall the bottom cover. (.Figure 3-4)



Figure 3-4: Reinstall the bottom cover

3.3 Wireless LAN Module Installation (Optional)

To install the optional wireless LAN (WLAN) module, please follow the steps below.

- Step 1:** Remove the bottom surface (see **section 3.2**).
- Step 2:** Remove the two knockout holes for antenna installation. The two knockout holes are located on the rear panel of the TANK-630-EHL Series as shown in **Figure 3-5**.

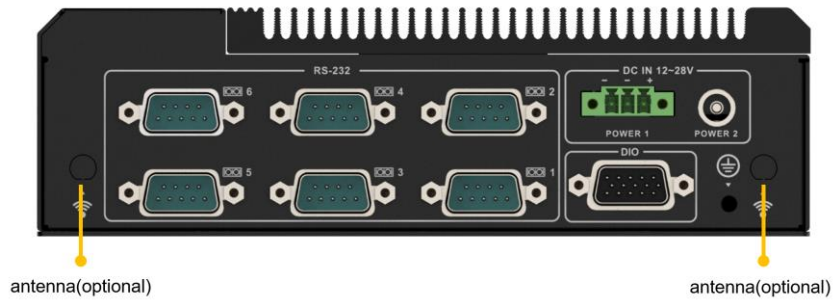

Figure 3-5: Knockout Holes for Wireless Antenna

- Step 3:** Locate the M.2 A-key slot (Figure 3-6).

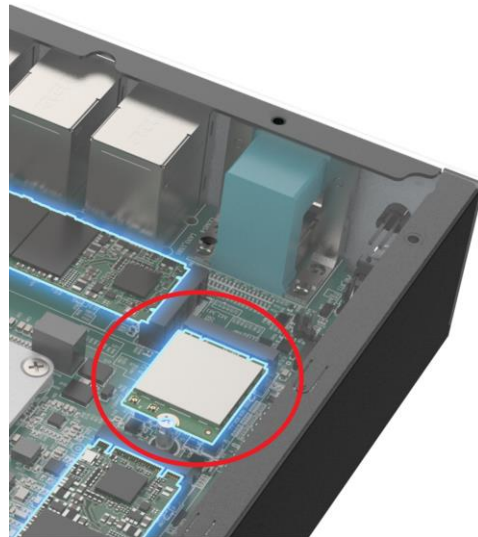

Figure 3-6: M.2 A-key Location

- Step 4:** **Remove the retention screw.** Remove the retention screw for M.2 card installation as shown in **Figure 3-7**.

TANK-630-EHL

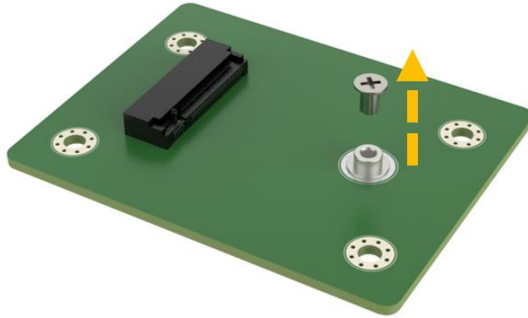

Figure 3-7: Removing the Retention Screw

Step 5: Insert into the socket at an angle. Line up the notch on the WLAN module with the notch on the slot. Slide the WLAN module into the slot at an angle of about 20° (Figure 3-8).

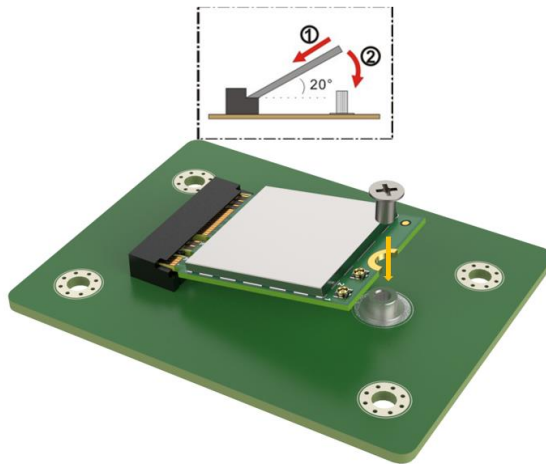

Figure 3-8: Inserting the WLAN Module

Step 6: Secure the WLAN module. Secure the WLAN module with the retention screw previously removed (Figure 3-9).

Step 7: Connect the two RF cables to the antenna connectors on the WLAN module (Figure 3-9).

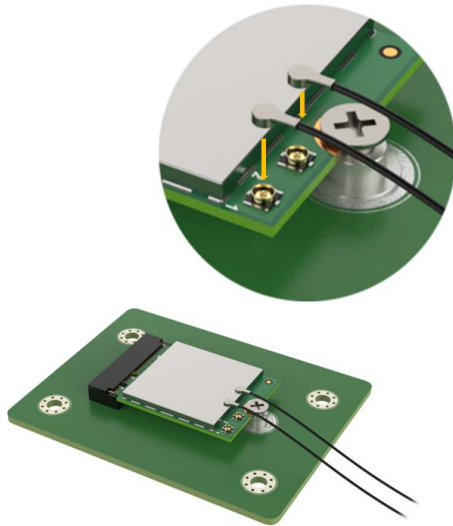

Figure 3-9: Securing WLAN Module and Connecting RF Cables

Step 8: Remove the nut and washer from the SMA connector at the other end of the RF cable.

Step 9: Insert the SMA connector to the antenna connector holes on the rear panel.

Step 10: Secure the SMA connector by inserting the washer and tightening it with nut.

Step 11: Install the external antenna.

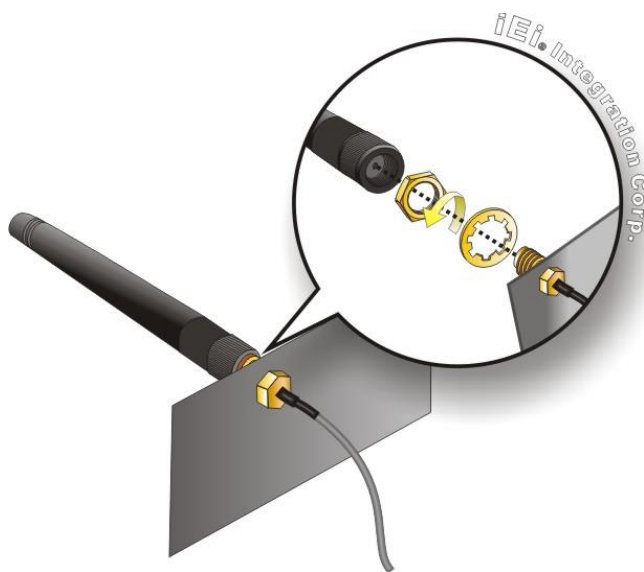

Figure 3-10: Securing SMA Connector and External Antenna Installation

TANK-630-EHL

3.4 Mounting the System

There are two ways to mount the TANK-630-EHL Series. The mounting instructions are described below.

3.4.1 Mounting with Mounting Brackets (Optional)

To mount the embedded system onto a wall or some other surface using the two mounting brackets, please follow the steps below.

Step 1: Turn the embedded system over.

Step 2: Align the mounting screw holes on each bracket with the corresponding mounting screw holes on the panel.

Step 3: Insert the retention screws into each bracket to lock the brackets to the system.

(Figure 3-11)



Figure 3-11: Mounting Bracket Retention Screw

3.4.2 DIN rail Mount Kit Installation (Optional)

Step 1: Attach the supplied DIN rail mounting bracket to the rear panel of the embedded system. Secure the bracket to the embedded system with three retention screws

(Figure 3-12)

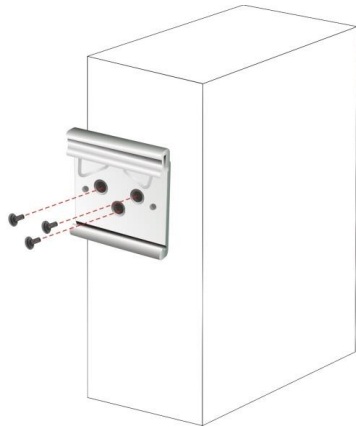

Figure 3-12: DIN Rail Mounting Bracket Installation



NOTE:

In the diagrams below, the DIN rail is already installed on a surface or on a chassis.

Step 2: Attach the upper edge of the mounting bracket to the DIN rail as shown in **Figure 3-13**

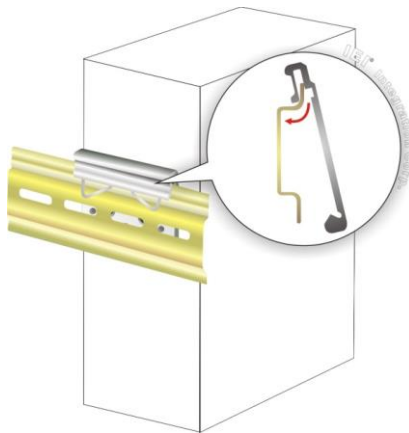

Figure 3-13: Attach the Mounting Bracket to the DIN Rail

Step 3: Push the system toward the DIN rail until the mounting bracket clips into place firmly (**Figure 3-14**)

TANK-630-EHL

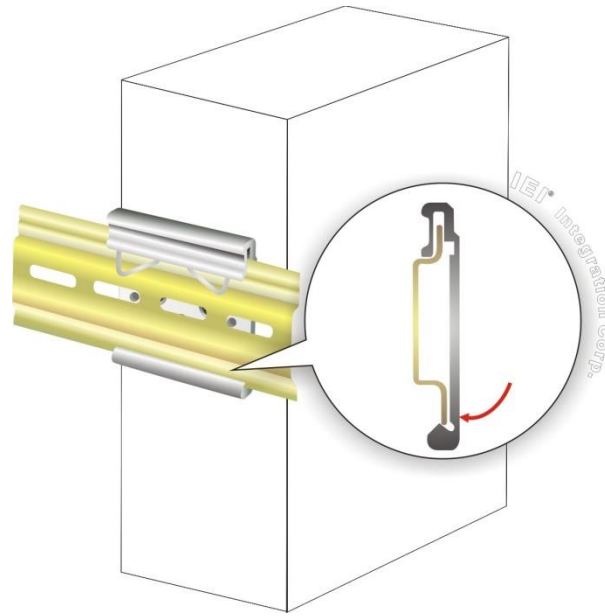

Figure 3-14: Mounting the System

3.5 AT/ATX Mode Selection

AT or ATX power mode can be used on the TANK-630-EHL Series. The selection is made through an AT/ATX switch located on the front panel. To select AT mode or ATX mode, follow the steps below.

Step 1: Locate the AT/ATX switch on the front panel (Figure 3-15).

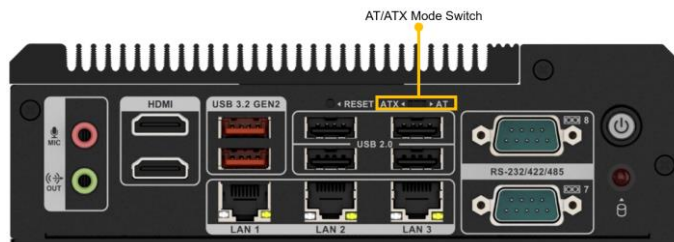

Figure 3-15: AT/ATX Switch Location

Step 2: Adjust the AT/ATX switch.

3.5.1 AT Power Mode

With the AT mode selected, the power is controlled by a central power unit rather than a power switch. The TANK-630-EHL Series system turns on automatically when the power

is connected. The AT mode benefits a production line to control multiple systems from a central management center and other applications including:

- ATM
- Self-service kiosk
- Plant environment monitoring system
- Factory automation platform
- Manufacturing shop flow

3.5.2 ATX Power Mode

With the ATX mode selected, the TANK-630-EHL Series system goes in a standby mode when it is turned off. The system can be easily turned on via network or a power switch in standby mode. Remote power control is perfect for advertising applications since the broadcasting time for each system can be set individually and controlled remotely. Other possible application includes

- Security surveillance
- Point-of-Sale (POS)
- Advertising terminal

TANK-630-EHL

3.6 External Peripheral Main Interface Connectors

The TANK-630-EHL Series has the following main connectors. Detailed descriptions of the connectors can be found in the subsections below.

- HDMI
- Ethernet
- USB
- Serial Ports
- DIO

3.6.1 HDMI Connector

To connect the HDMI devices, please plug in HDMI connector in the right direction as shown below:

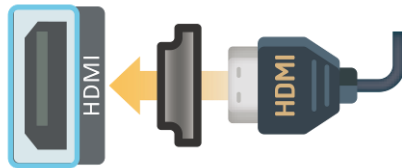

Figure 3-16: HDMI Connection

3.6.2 LAN Connectors

The LAN connectors allow connection to an external network

Step 1: Locate the RJ-45 connectors. The locations of the RJ-45 connectors are shown in **Chapter 1**

Step 2: Align the connectors. Align the RJ-45 connector on the LAN cable with one of the RJ-45 connectors on the TANK-630-EHL Series. See Figure 3-17

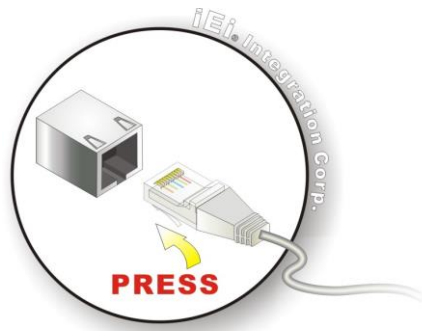

Figure 3-17: LAN Connection

Step 3: Insert the LAN cable RJ-45 connector. Once aligned, gently insert the LAN cable RJ-45 connector into the on-board RJ-45 connector

The RJ-45 Ethernet connector has two status LEDs, one green and one yellow. The green LED indicates activity on the port and the yellow LED indicates the port is linked.



Figure 3-18: RJ-45 Ethernet Connector

Activity/Link LED		Speed LED	
STATUS	DESCRIPTION	STATUS	DESCRIPTION
Off	No link	Off	10 Mbps connection
Yellow	Linked	Orange	1000 Mbps connection
Blinking	TX/RX activity	Green	2.5 Gbps connection

Table 3-1: LAN1-3 2.5GbE RJ-45 Ethernet Connector LEDs

TANK-630-EHL

3.6.3 DB9 Serial Port Connectors

The TANK-630-EHL Series has two RS-232/422/485 serial ports (COM7-8) and six RS-232 serial ports (COM1-COM6). The pinouts for the serial ports are listed in the **Table 3-2**.

PIN NO.	RS232	RS422	RS485
1	DCD#	TX-	TX-
2	RXD	TX+	TX+
3	TXD	RX+	
4	DTR#	RX-	
5	GND		
6	DSR#		
7	RTS#		
8	CTS#		
9	RI#		

Table 3-2: Serial Ports Connector Pinouts

3.6.4 USB Connectors

The TANK-630-EHL has two USB 3.2 ports and four USB 2.0 Ports. To connect a USB device, please follow the instructions below

Step 1: Located the USB connectors. The locations of the USB connectors are shown in **Chapter 1**

Step 2: Align the connectors. Align the USB device connector with one of the connectors on the I/O panel.

Step 3: Insert the device connector. Once aligned, gently insert the USB device connector into the onboard connector.

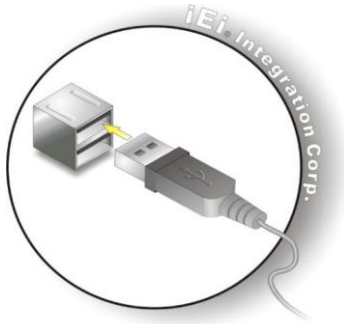

Figure 3-19: USB Connection

3.6.5 DIO Connector

The digital I/O connector provides programmable input and output for external devices. The digital I/O provides 4-bit output and 4-bit input. The pinouts of the D-sub 9 male connector are listed below (**Table 3-3**).

Pin	Description	Pin	Description
1	DIN0	6	DOUT2
2	DOUT0	7	DIN3
3	DIN1	8	DOUT3
4	DOUT1	9	+V5
5	DIN2		

Table 3-3: Digital IO Connector Pinouts

TANK-630-EHL

3.7 Powering On/Off the System

**WARNING:**

Make sure a power supply with the correct input voltage is being fed into the system. Incorrect voltages applied to the system may cause damage to the internal electronic components and may also cause injury to the user.

- **Power on** the system: press the power button for 3 seconds
- **Power off** the system: press the power button for 6 seconds

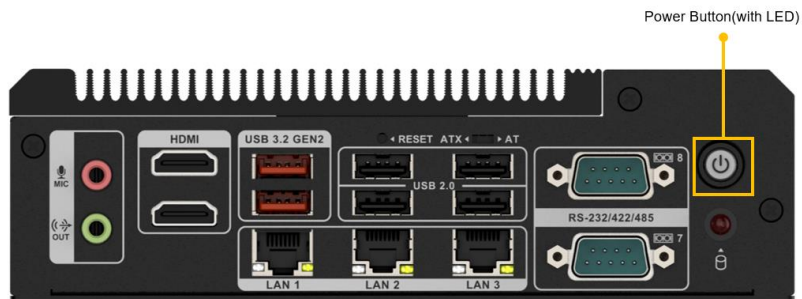

Figure 3-20: Power Button

3.8 Reset the System

The reset button enables user to reboot the system when the system is turned on. To reboot the system, follow the steps below.

Step 3: Locate the reset button on the front panel (**Figure 3-21**).

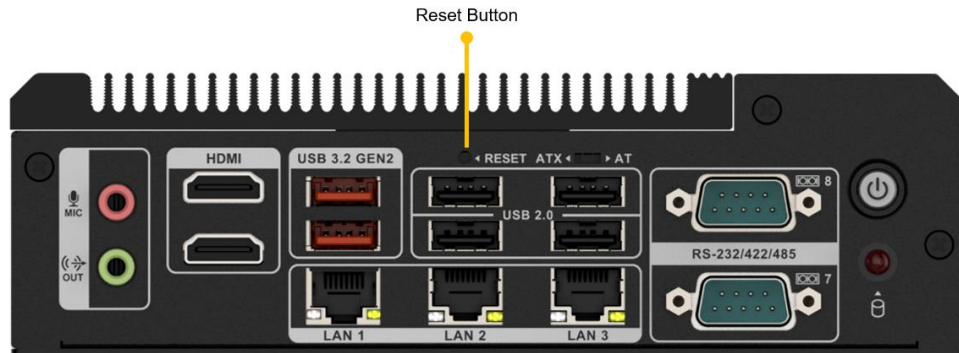

Figure 3-21: Reset Button Location

Step 4: Press the reset button.

TANK-630-EHL

3.9 Available Drivers

All the drivers for the TANK-630-EHL Series are available on IEI Resource Download Center (<https://download.ieiworld.com>). Type TANK-630-EHL Series and press Enter to find all the relevant software, utilities, and documentation.

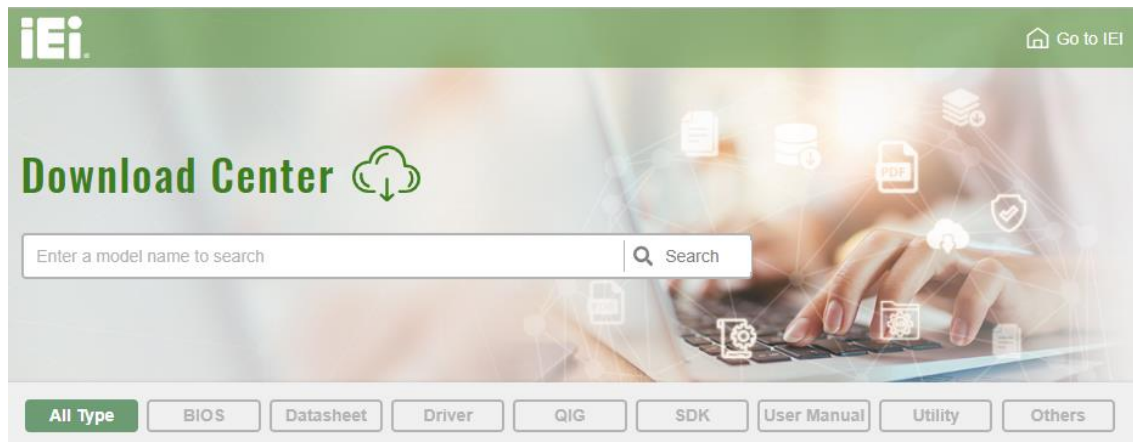

IEI Resource Download Center

3.9.1 Driver Download

To download drivers from IEI Resource Download Center, follow the steps below.

Step 5: Go to <https://download.ieiworld.com>. Type TANK-630-EHL Series and press Enter.

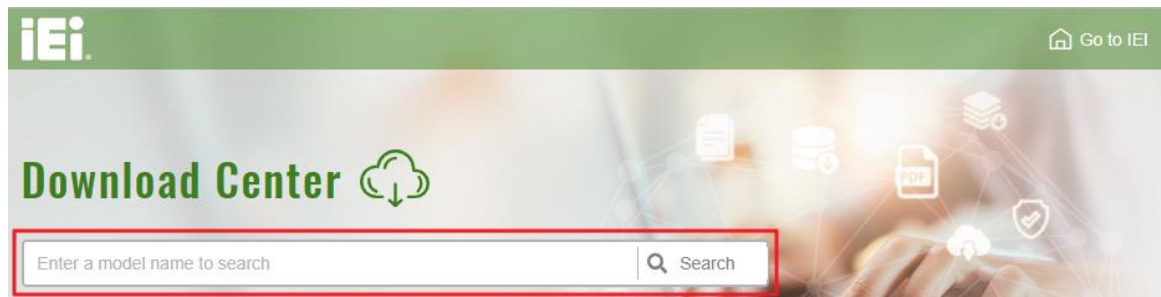

Step 6: All product-related software, utilities, and documentation will be listed. You can choose **Driver** to filter the result.

[All Type](#)
[BIOS](#)
[Datasheet](#)
[Driver](#)
[QIG](#)
[SDK](#)
[User Manual](#)
[Utility](#)
[Others](#)

WAFER-BT-i1 Product Info ▶

[Embedded Computer](#) ▶ [Single Board Computer](#) ▶ [Embedded Board](#)
 3.5" SBC with Intel® 22nm Atom™/Celeron® on-board SoC

Driver

File Name	Published	Version	File Checksum
7B000-001033-RS V2.3.iso (2.23 GB)	2017/10/03	2.30	3B2DB1F792779A93A8F50DDBC3943E30

Step 7: Click the driver file name on the page and you will be prompted with the following window. You can download the entire ISO file (❶), or click the small arrow to find an individual driver and click the file name to download (❷).

7B000-001168-RS_V1.4.iso

❶ [Click here to download entire ISO file. \(2.99 GB\)](#)

* Download individual file *

- Docs
 - 1.Chipset
 - 10.1.1.12.zip (2.7 MB)
 - 2.VGA
 - 3.Audio
 - 4.Lan
 - 5.USB 3.0
 - 6.Serial IO
 - 7.TXE
 - 8.Manual

NOTE:

To install software from the downloaded ISO image file in Windows 10 (or later), double-click the ISO file to mount it as a virtual drive to view its content.

Chapter

4

System Motherboard

4.1 Overview

The connectors and jumpers of the system motherboard are listed in the following sections.

4.2 Layout

The following diagram shows the locations of the internal/external connectors and jumpers on the motherboard.

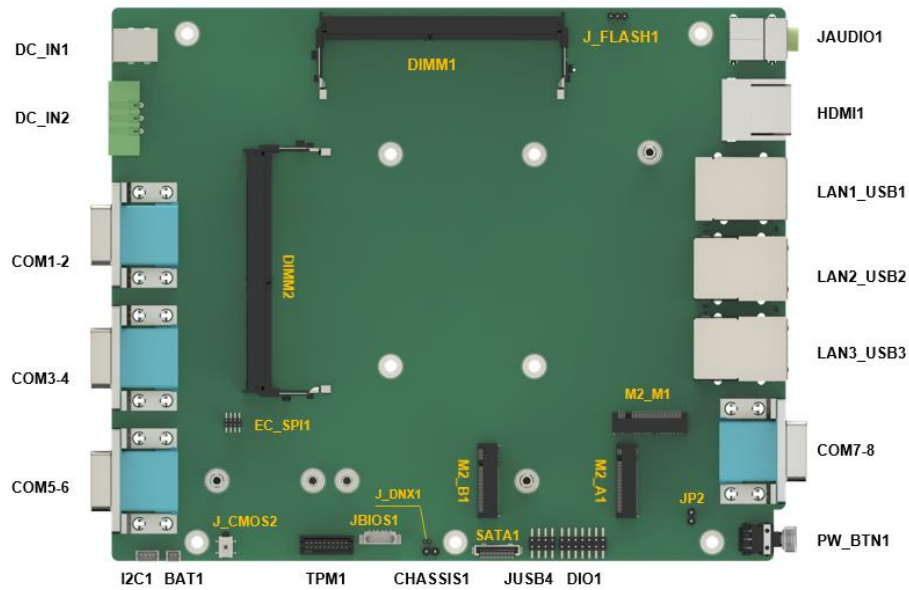

Figure 4-1: System Motherboard (Front)

TANK-630-EHL

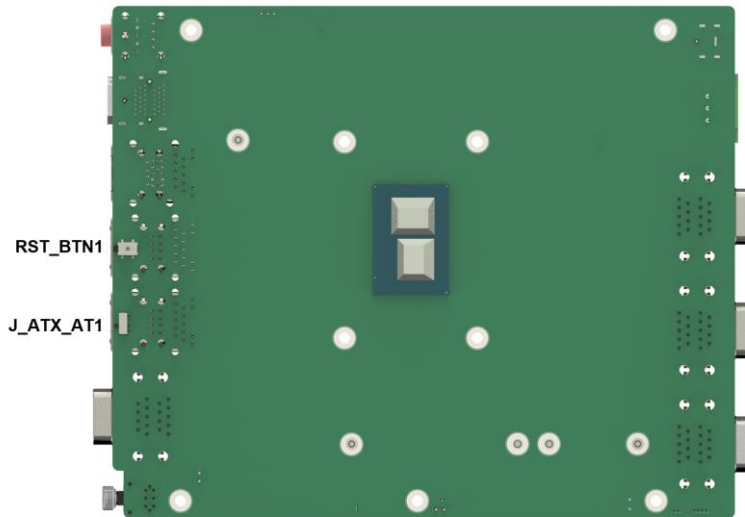

Figure 4-2: System Motherboard (Rear)

4.3 External Interface Connectors

The table below lists all the external connectors.

Connector	Type	Label
Reset button	Button	RST_BTN1
AT/ATX power mode setting	Switch	J_ATX_AT1
LAN+USB connector	RJ45+USB 3.1 GEN2	LAN1_USB1 LAN2_USB2 LAN3_USB3
RS-232/422/485 serial port connectors	DB9 male	COM7-8
RS-232 serial port connectors	DB9 male	COM1-2 COM3-4 COM5-6
DC power in (12V input)	4-pin jack	DC_IN1
Audio jack (mic-in, line-out)	4-pin jack	JAUDIO1
DC power in (12-28V input)	3-pin terminal	DC_IN2

PWR button	2-pin TACT switch	PW_BTN1
HDMI connector	19-pin female	HDMI1, HDMI2

Table 4-1: Peripheral Interface Connectors

4.3.1 AT//ATX Power Mode Setting

- CN Label:** J_ATX_AT1
- CN Type:** 3-pin switch
- CN Location:** See Figure 4-3
- CN Pinouts:** See Table 4-2

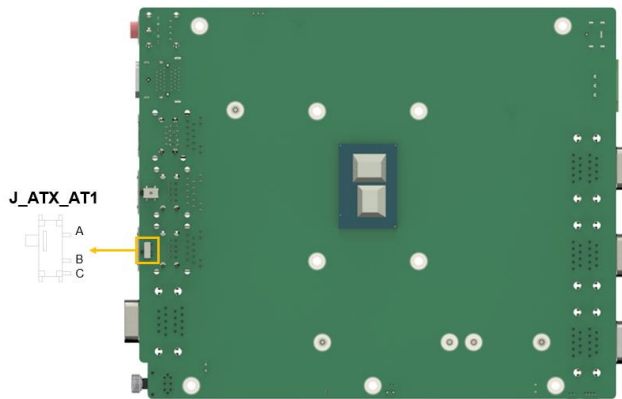

Figure 4-3: AT/ATX Power Mode Switch Locations

PIN NO.	DESCRIPTION
Short A - B	ATX Power Mode (default)
Short B - C	AT Power Mode

Table 4-2: AT/ATX Power Mode Switch Pinouts

TANK-630-EHL

4.3.2 Reset Button Mode Setting

- CN Label:** RST_BTN1
- CN Type:** Electronic Switch
- CN Location:** See **Figure 4-4**
- CN Pinouts:** See **Table 4-3**

The Reset Button is commonly used in electronic devices and computers to solve problems with the device or system and reset it to default or factory settings.

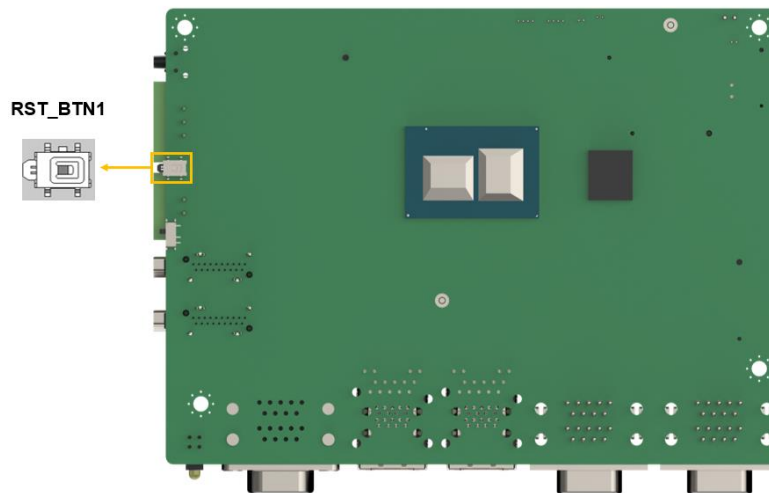

Figure 4-4: Reset Button Location

PIN NO.	DESCRIPTION
NC (default)	
Press button	Reset Button

Table 4-3: Reset Button Pinouts

4.4 Internal Interface Connectors

The table below lists all the connectors on the board.

Connector	Type	Label
Clear CMOS button	Button	J_CMOS2
DDR4 SO-DIMM Socket	260-pin socket	DIMM1 DIMM2
SPI TPM Connector	20-pin header	TPM1
Flash descriptor override setting jumper	3-pin header	J_FLASH1
DNX mode setting jumper	2-pin header	J_DNX1
Flash SPI ROM connector	6-pin wafer	JBIOS1
Internal USB 2.0 connector	8-pin header	JUSB4
SATA 6Gb/s connector	20-pin SATA connector	ISATA1
I2C connector	4-pin wafer	I2C1
Flash EC ROM connector	8-pin header	EC_SPI1
Battery connector	2-pin wafer	BAT1
DIO Connector	14-pin header	DIO1
HDD LED Connector	2-pin header	JP2
Front panel connector	2-pin header	CHASSIS1
M.2 B-key slot	M.2 B-key slot	M2_B1,
M.2 M-key slot	M.2 M-key slot	M2_M1
M.2 A-key slot	M.2 A-key slot	M2_A1

Table 4-4: Peripheral Interface Connectors

4.4.1 Clear CMOS Button Connector

- CN Label:** J_CMOS2
- CN Type:** Button
- CN Location:** See **Figure 4-5**
- CN Pinouts:** See **Table 4-5**

TANK-630-EHL

To clear the CMOS Setup (for example if you have forgotten the password, you should clear the CMOS and then reset the password), you should disconnect the RTC battery and press the button for about 3 seconds. This will set back to normal operation mode.

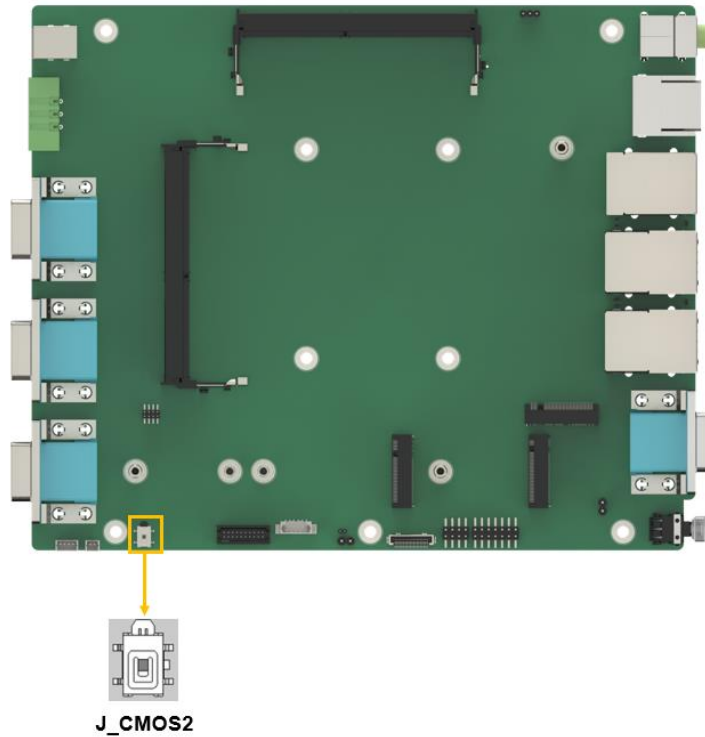

Figure 4-5: Clear CMOS Location

PIN NO.	DESCRIPTION
NC (default)	Keep CMOS Setup (Normal Operation)
Press button	Clear CMOS Setup

Table 4-5: Clear CMOS Pinouts

4.4.2 DNX Mode Setting Jumper

- CN Label:** J_DNX1
- CN Type:** 2-pin header, P=1.27mm
- CN Location:** See **Figure 4-6**
- CN Pinouts:** See **Table 4-6**

The J_DNX1 connector is used for set DNX mode.

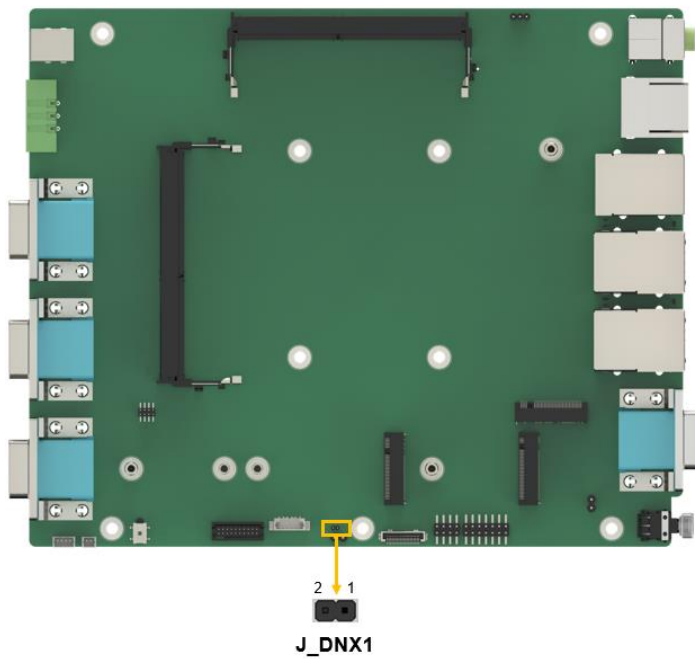

Figure 4-6: DNX Mode Setting Jumper Location

PIN NO.	DESCRIPTION
Open	Normal (default)
Short	Enable DNX Boot

Table 4-6: DNX Mode setting Jumper Pinouts

TANK-630-EHL

4.4.3 Flash Descriptor Override Setting Jumper

- CN Label:** J_FLASH1
- CN Type:** 3-pin header, P=2.00mm
- CN Location:** See **Figure 4-7**
- CN Pinouts:** See **Table 4-7**

The J_FLASH1 connector is used for Flash Descriptor Security Override.

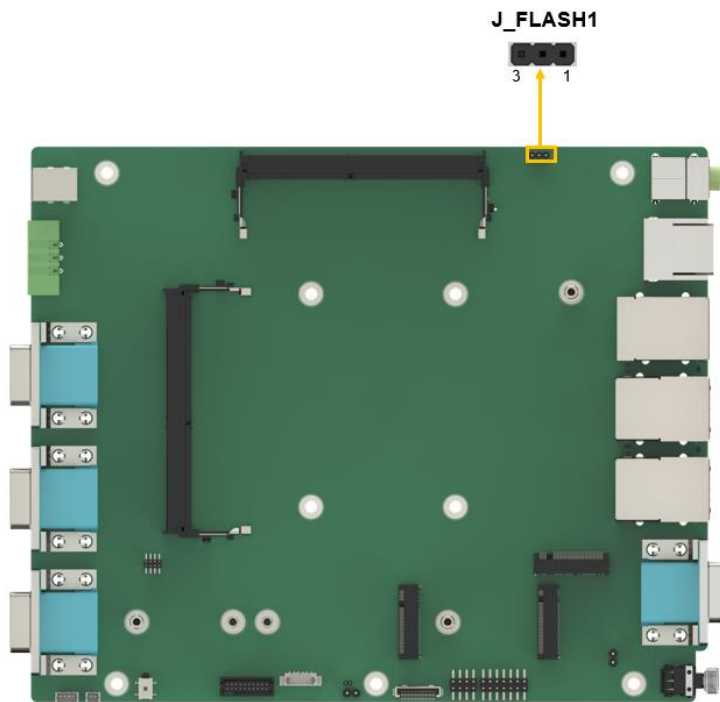

Figure 4-7: Flash Descriptor Override Setting Jumper Locations

PIN NO.	DESCRIPTION
Short 1 - 2	Disable (Default)
Short 2 - 3	Enable

Table 4-7: Flash Descriptor Override Setting Jumper Pinouts

To update the ME firmware, please follow the steps below.

- Step 1:** Before turning on the system power, short the Flash Descriptor Security Override jumper.
- Step 2:** Update the BIOS and ME firmware, and then turn off the system power.
- Step 3:** Remove the metal clip on the Flash Descriptor Security Override jumper to its default setting.
- Step 4:** Restart the system. The system will reboot 2 ~ 3 times to complete the ME firmware update.

4.4.4 RTC Battery Connector



CAUTION:

Risk of explosion if battery is replaced by an incorrect type. Only certified engineers should replace the on-board battery.

Dispose of used batteries according to instructions and local regulations.



NOTE:

It is recommended to attach the RTC battery onto the system chassis in which the TANK-630-EHL Series is installed.

CN Label:	BAT1
CN Type:	2-pin wafer, p=1.25 mm
CN Location:	See Figure 4-8
CN Pinouts:	See Table 4-8

The battery connector is connected to the system battery. The battery provides power to the system clock to retain the time when power is turned off.

TANK-630-EHL

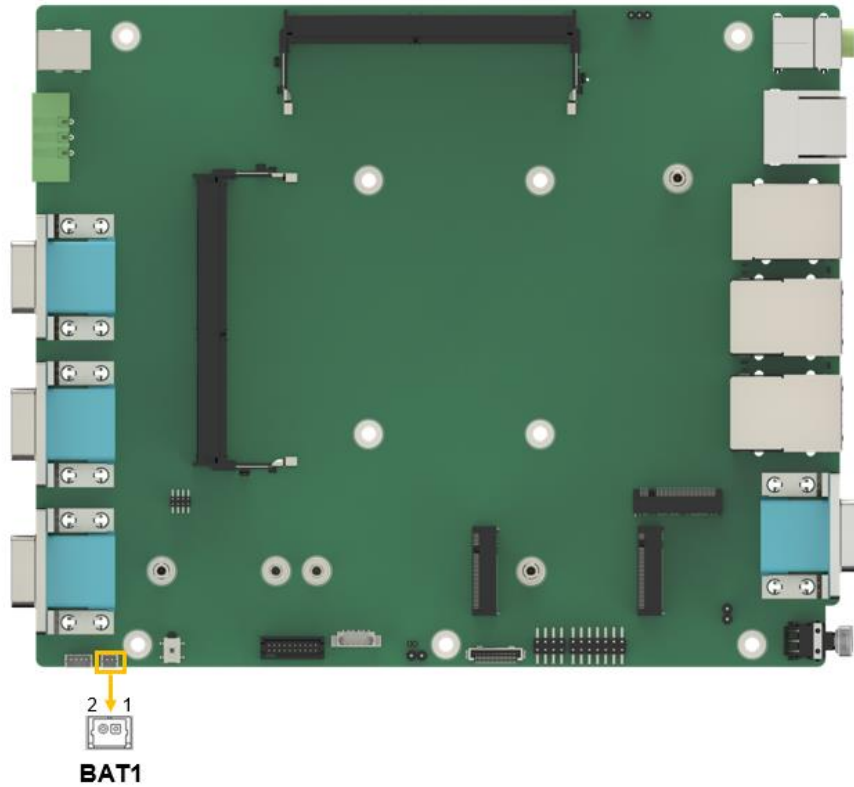

Figure 4-8: Battery Connector Location

Pin	Description
1	VBATT
2	GND

Table 4-8: Battery Connector Pinouts

4.4.5 DDR4 SO-DIMM Socket

- CN Label:** DIMM1, DIMM2
- CN Type:** 260-pin DDR4 SO-DIMM slot
- CN Location:** See **Figure 4-9**

The SO-DIMM slots are for installing the DDR4 SO-DIMM.

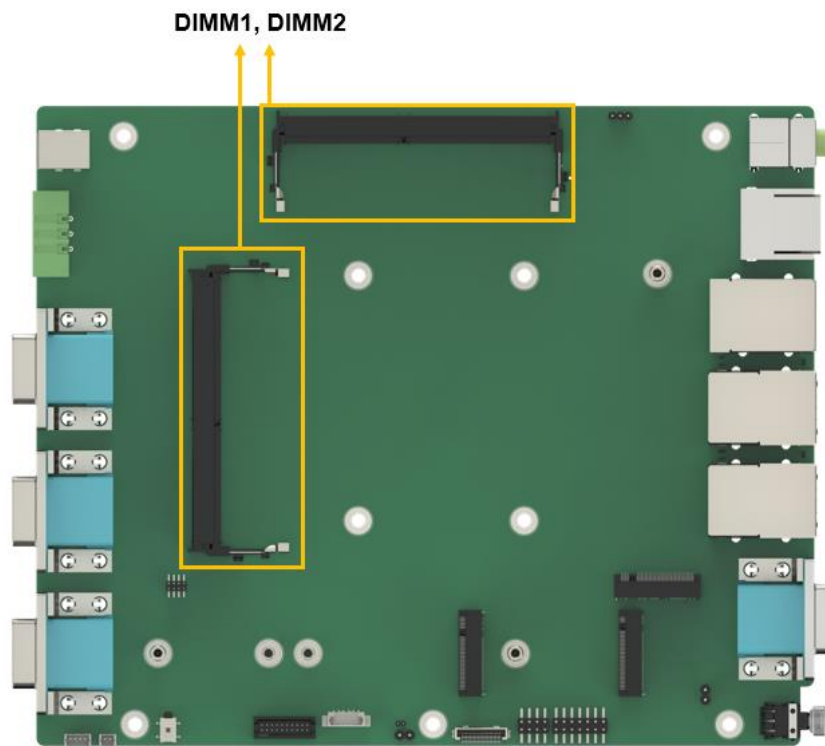

Figure 4-9: DDR4 SO-DIMM Connectors Location

TANK-630-EHL

4.4.6 Mini SATA Connector

- CN Label:** ISATA1
- CN Type:** 20-pin Mini SATA connector
- CN Location:** See **Figure 4-10**
- CN Pinouts:** See **Table 4-9**

The SATA 6Gb/s drive connector is connected to a SATA 6Gb/s drive. The SATA 6Gb/s drive transfers data at speeds as high as 6Gb/s.

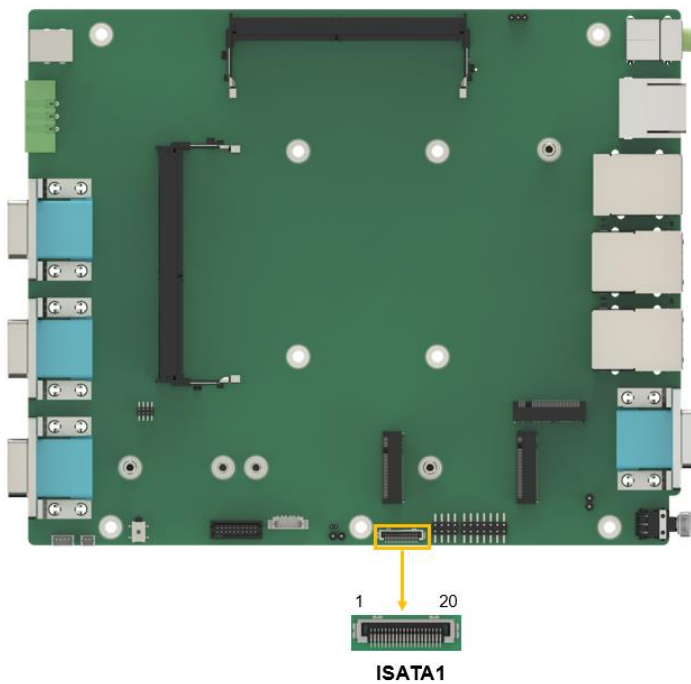

Figure 4-10: Mini SATA Connectors Location

PIN NO.	DESCRIPTION	PIN NO.	DESCRIPTION
1	GND	11	+5VS
2	GND	12	N/C
3	GND	13	N/C
4	GND	14	GND
5	GND	15	SATA RX+
6	GND	16	SATA_RX-
7	+5VS	17	GND

8	+5VS	18	SATA_TX-
9	+5VS	19	SATA_TX+
10	+5VS	20	GND

Table 4-9: SATA 6Gb/s Drive Connectors Pinouts

4.4.7 Flash SPI ROM Connector

- CN Label:** JBIOS1
- CN Type:** 6-pin wafer, p=1.25 mm
- CN Location:** See **Figure 4-11**
- CN Pinouts:** See **Table 4-10**

The 6-pin Flash SPI ROM connector is used to flash the BIOS.

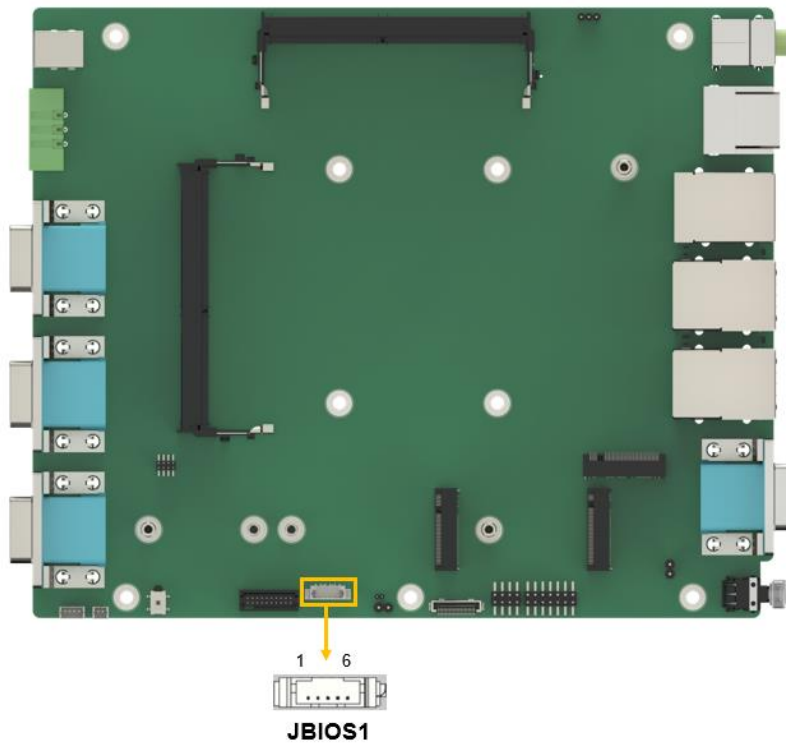

Figure 4-11: Flash SPI ROM Connector Location

TANK-630-EHL

Pin	Description
1	+3.3V
2	SPI_CS#
3	SPI SO
4	SPI CLK
5	SPI SI
6	GND

Table 4-10: Flash SPI ROM Connector Pinouts

4.4.8 Flash EC ROM Connector

- CN Label:** EC_SPI1
- CN Type:** 8-pin header, p=1.27 mm
- CN Location:** See Figure 4-12
- CN Pinouts:** See Table 4-11

The 8-pin Flash EC ROM connector is used to flash the EC internal ROM.

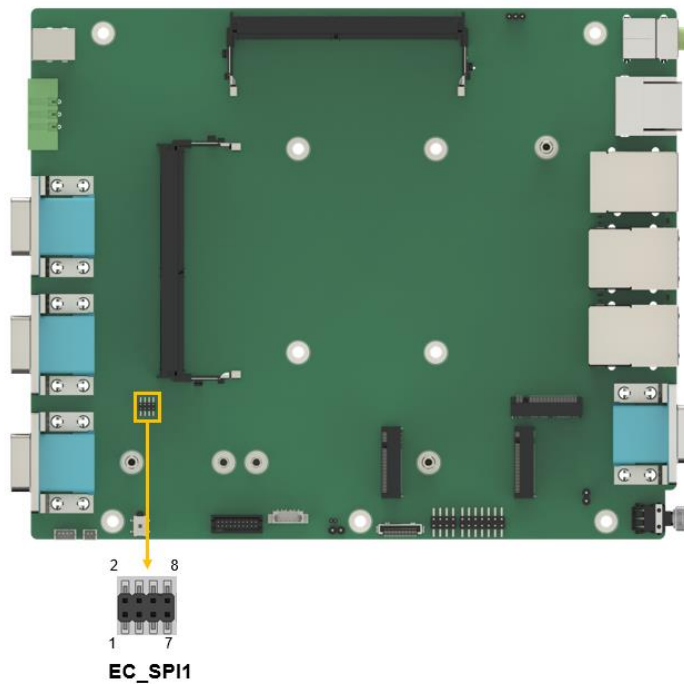

Figure 4-12: Flash EC ROM Connector Location

Pin	Description	Pin	Description
1	SPI_CS#	2	+3.3V
3	SPI_SO	4	NC
5	EC_DET_FLASH	6	SPI_CLK
7	GND	8	SPI_SI

Table 4-11: Flash EC ROM Connector Pinouts

4.4.9 I²C Connector

- CN Label:** I2C1
- CN Type:** 4-pin wafer, p=1.25 mm
- CN Location:** See **Figure 4-13**
- CN Pinouts:** See **Table 4-12**

The SMBus (System Management Bus) connector provides low-speed system management communications.

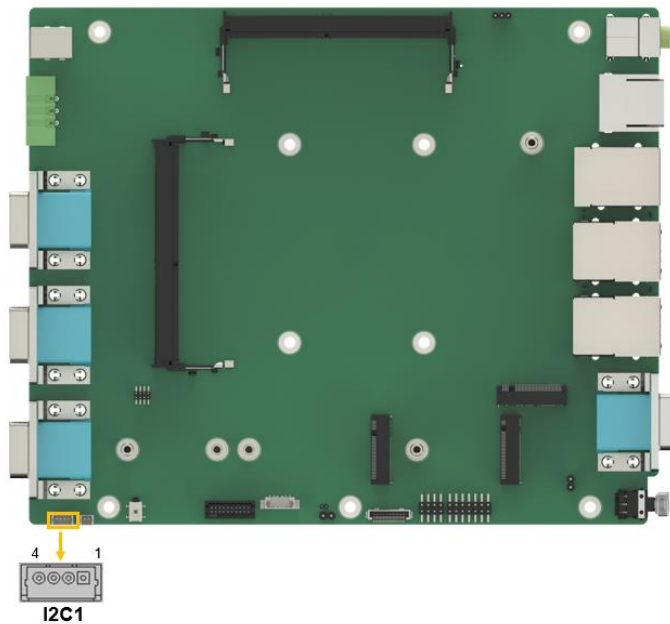

Figure 4-13: I²C Connector Location

TANK-630-EHL

Pin	Description
1	GND
2	I2C_DATA
3	I2C_CLK
4	+5V

Table 4-12: I²C Connector Pinouts

4.4.10 Internal USB 2.0 Connectors

- CN Label:** JUSB1
- CN Type:** 8-pin header, p=2.00 mm
- CN Location:** See **Figure 4-14**
- CN Pinouts:** See **Table 4-13**

The USB connector provides USB 2.0 ports by dual-port USB cable.

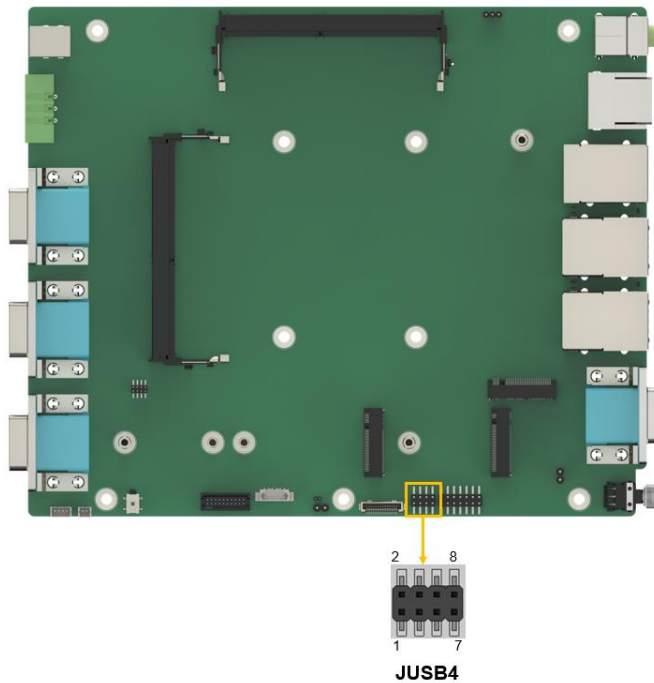

Figure 4-14: Internal USB 2.0 Connectors Locations

PIN NO.	DESCRIPTION	PIN NO.	DESCRIPTION
1	VCC	2	GND
3	USB DATA-	4	USB DATA+
5	USB DATA+	6	USB DATA-
7	GND	8	VCC

Table 4-13: Internal USB 2.0 Connectors Pinouts

4.4.11 HDD LED Connector

- CN Label:** JP2
- CN Type:** 2-pin header, p=2.54 mm
- CN Location:** See Figure 4-15
- CN Pinouts:** See Table 4-14

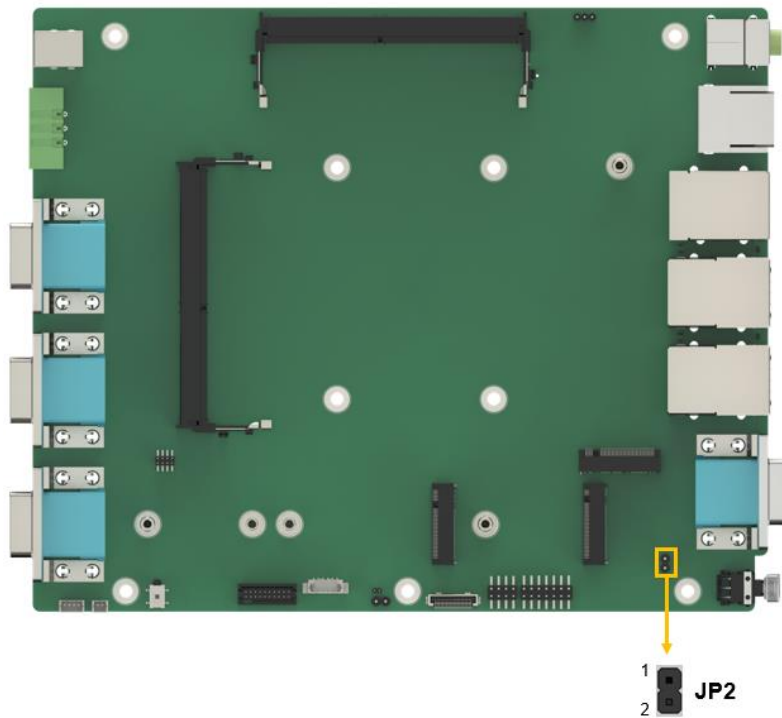

Figure 4-15: HDD LED Connector Location

TANK-630-EHL

Pin	Description
1	SATA_LED
2	+3VP3S

Table 4-14: HDD LED Connector Pinouts

4.4.12 SPI TPM Connector

- CN Label:** TPM1
- CN Type:** 20-pin header
- CN Location:** See Figure 4-16
- CN Pinouts:** See Table 4-15

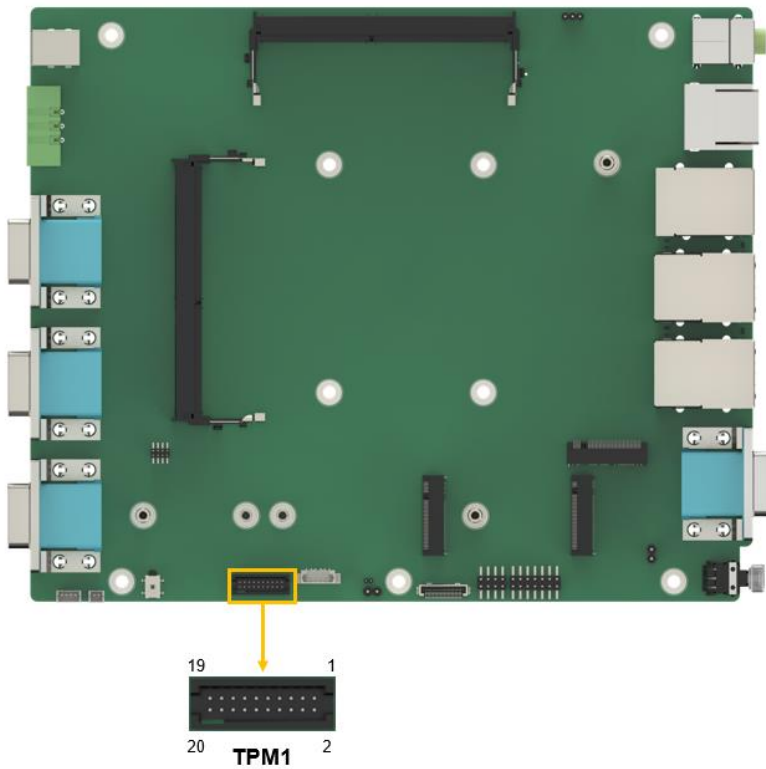

Figure 4-16: SPI TPM Connectors Location

PIN NO.	DESCRIPTION	PIN NO.	DESCRIPTION
1	N/A	2	TPM_SPI_CS0_N
3	+V3.3	4	TPM_SPI_CS1_N
5	GND	6	+V3.3
7	SPI_CLK_TPM	8	SPI_TPM_DQ2
9	TPM_SPI_DQ3	10	TPM_SPI_MISO
11	SPI_TPM_HOLD_R_N	12	TPM_SPI_MOSI
13	SPI_TPM_CS2_R	14	GND
15	TPM_WP#	16	N/A
17	SPI_TPM_INT_N	18	+V3.3
19	PLT_RST_N	20	+V3.3

Table 4-15: SPI TPM Connector (TPM1) Pinouts

4.4.13 Digital Input / Output Connector

- CN Label:** DIO1
- CN Type:** 14-pin header, p=2.0 mm
- CN Location:** See **Figure 4-17**
- CN Pinouts:** See **Table 4-16**

The 12-bit digital I/O connector provides programmable input and output for external devices.

TANK-630-EHL

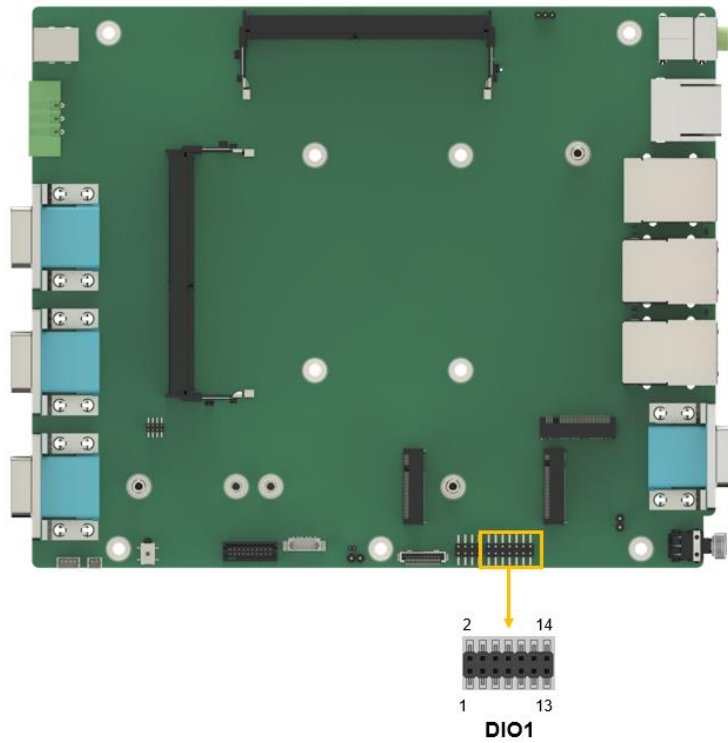

Figure 4-17: Digital I/O Connector Location

PIN NO.	DESCRIPTION	PIN NO.	DESCRIPTION
1	GND	2	VCC
3	DOUT5	4	DOUT4
5	DOUT3	6	DOUT2
7	DOUT1	8	DOUT0
9	DIN5	10	DIN4
11	DIN3	12	DIN2
13	DIN1	14	DIN0

Table 4-16: Digital I/O Connector Pinouts

4.4.14 Case Open Circuit Setting

- CN Label:** CHASSIS1
- CN Type:** 2-pin header, P=2.54 mm
- CN Location:** See **Figure 4-18**
- CN Pinouts:** See **Table 4-17**

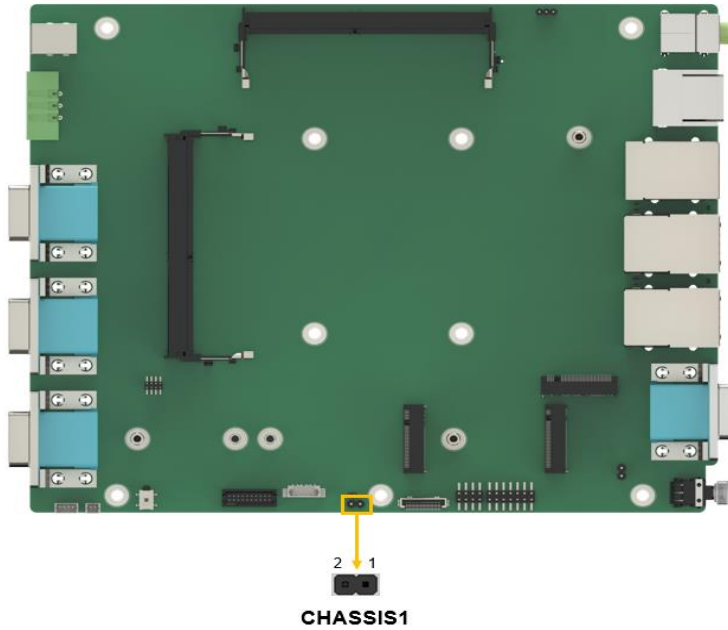

Figure 4-18: Case Open Circuit Setting Location

PIN NO.	DESCRIPTION
Open	Chassis close
Short	Chassis open

Table 4-17: Case Open Circuit Setting Location Pinouts

TANK-630-EHL

4.4.15 M.2 A-key Slot

- CN Label:** M2_A1
- CN Type:** M.2 A-key slot
- CN Location:** See **Figure 4-19**
- CN Pinouts:** See **Table 4-18**

The M.2 B key (2242) slot with PCIe Gen3 x2 signals.

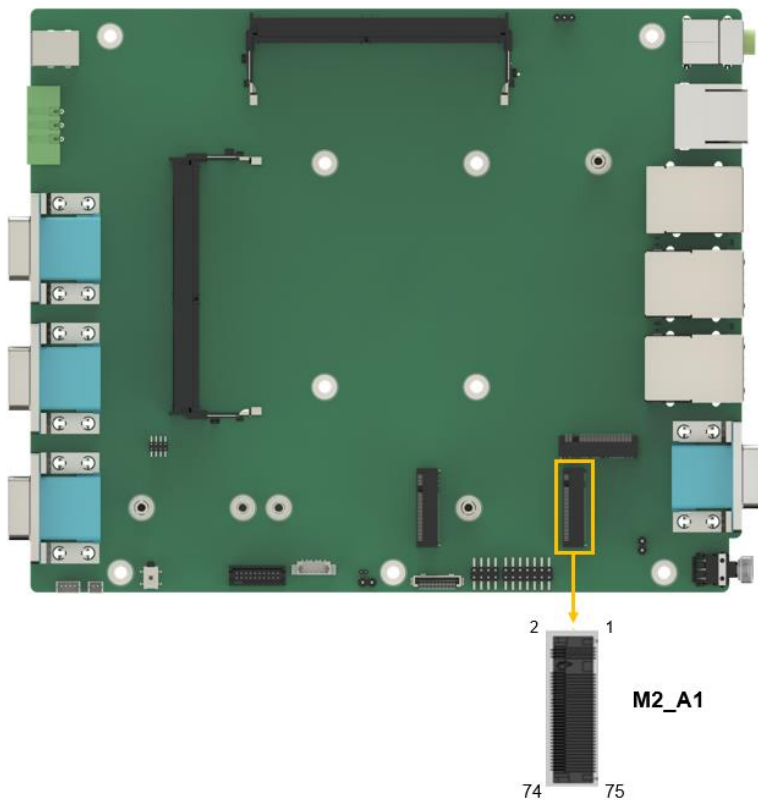

Figure 4-19: M.2 A-key Slot Location

Pin	Description	Pin	Description
1	GND	2	+V3.3A
3	USB+	4	+V3.3A
5	USB-	6	NC

Pin	Description	Pin	Description
7	GND	8	Module Key
9	Module Key	10	Module Key
11	Module Key	12	Module Key
13	Module Key	14	Module Key
15	Module Key	16	NC
17	NC	18	GND
19	NC	20	NC
21	NC	22	NC
23	GND	24	GND
25	NC	26	NC
27	NC	28	NC
29	GND	30	GND
31	NC	32	NC
33	GND	34	NC
35	PCIE_TX2+	36	GND
37	PCIE_TX2-	38	NC
39	GND	40	NC
41	PCIE_RX2+	42	NC
43	PCIE_RX2-	44	NC
45	GND	46	NC
47	CLK_PCIE2+	48	NC
49	CLK_PCIE2-	50	PMC_SUS_CLK
51	GND	52	WLAN_PERST#
53	NC	54	+V3.3A_WLAN
55	+V3.3A_WLAN	56	+V3.3A_WLAN
57	GND	58	NC
59	NC	60	NC
61	NC	62	NC
63	GND	64	NC
65	NC	66	NC
67	NC	68	NC
69	GND	70	NC
71	NC	72	+V3.3A

TANK-630-EHL

Pin	Description	Pin	Description
73	NC	74	+V3.3A
75	GND		

Table 4-18: M.2 A-Key Slot Pinouts

4.4.16 M.2 B-key Slot

- CN Label:** M2_B1
- CN Type:** M.2 B-key slot
- CN Location:** See Figure 4-20
- CN Pinouts:** See Table 4-19

The M.2 B key (2242) slot with SATA signal.

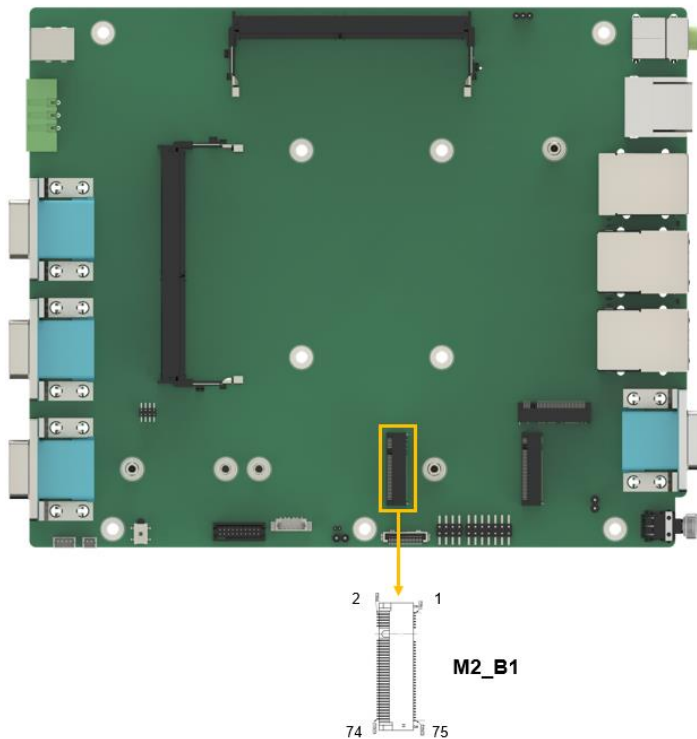

Figure 4-20: M.2 B-key Slot Location

Pin	Description	Pin	Description
1	GND	2	+V3.3_B2
3	GND	4	+V3.3_B2

Pin	Description	Pin	Description
5	GND	6	NC
7	NC	8	NC
9	NC	10	+V3.3_B2
11	GND	12	NC
13	Module Key	14	Module Key
15	Module Key	16	Module Key
17	Module Key	18	Module Key
19	Module Key	20	Module Key
21	GND	22	NC
23	NC	24	NC
25	NC	26	NC
27	GND	28	NC
29	NC	30	NC
31	NC	32	NC
33	GND	34	NC
35	NC	36	NC
37	NC	38	NC
39	GND	40	M.2_SMCLK
41	SATA_RX0+	42	M.2_SMDAT
43	SATA_RX0-	44	NC
45	GND	46	NC
47	SATA_RX0+	48	NC
49	SATA_RX0-	50	PLT_RST_N
51	GND	52	NC
53	NC	54	NC
55	NC	56	NC
57	GND	58	NC
59	NC	60	NC
61	NC	62	NC
63	NC	64	NC
65	NC	66	NC
67	NC	68	NC
69	GND	70	+V3.3

TANK-630-EHL

Pin	Description	Pin	Description
71	GND	72	+V3.3
73	GND	74	+V3.3
75	GND		

Table 4-19: M.2 B-Key Slot Pinouts

4.4.17 M.2 M-key Slot

- CN Label:** M2_M1
- CN Type:** M.2 M-key slot
- CN Location:** See Figure 4-21
- CN Pinouts:** See Table 4-20

The M.2 M key (2280) slot with PCIe Gen3 x2 supports NVMe storage.

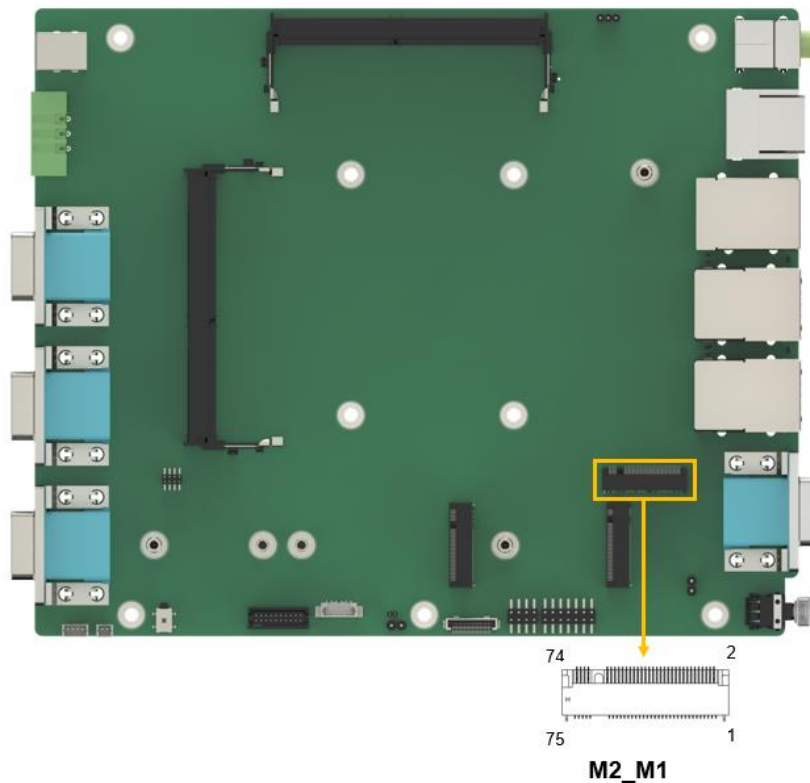

Figure 4-21: M.2 M-key Slot Location

PIN NO.	DESCRIPTION	PIN NO.	DESCRIPTION
1	GND	2	+V3P3S
3	GND	4	+V3P3S
5	NC	6	NC
7	NC	8	NC
9	GND	10	NGFF1_ACT_N
11	NC	12	+V3P3S
13	NC	14	+V3P3S
15	GND	16	+V3P3S
17	NC	18	+V3P3S
19	NC	20	NC
21	GND	22	NC
23	NC	24	NC
25	NC	26	NC
27	GND	28	NC
29	PCIE_RXN5	30	NC
31	PCIE_RXP5	32	NC
33	GND	34	NC
35	PCIE_TXN5_C	36	NC
37	PCIE_TXP5_C	38	GND
39	GND	40	M.2_SMCLK
41	PCIE_RXN4	42	M.2_SMDAT
43	PCIE_RXP4	44	M.2_Alert#
45	GND	46	NC
47	PCIE_TXN4	48	NC
49	PCIE_TXP4	50	PLT_RST_N
51	GND	52	PLT_RST_N
53	CLK_M2_M_N	54	TP313
55	CLK_M2_M_P	56	N/C
57	GND	58	N/C
59	Module Key	60	Module Key
61	Module Key	62	Module Key
63	Module Key	64	Module Key

TANK-630-EHL

65	Module Key	66	Module Key
67	NC	68	TP314
69	NC	70	+V3P3S
71	GND	72	+V3P3S
73	GND	74	+V3P3S
75	GND		

Table 4-20: M.2 M-key Slot Pinouts

Chapter

5

BIOS

TANK-630-EHL

5.1 Introduction

The BIOS is programmed onto the BIOS chip. The BIOS setup program allows changes to certain system settings. This chapter outlines the options that can be changed.



NOTE:

Some of the BIOS options may vary throughout the life cycle of the product and are subject to change without prior notice.

5.1.1 Starting Setup

The UEFI BIOS is activated when the computer is turned on. The setup program can be activated in one of two ways.

1. **Using keyboard:** Press the **DEL** or **F2** as soon as the system is turned on.
2. **Using touchscreen:** Press the **Setup** button on the upper right corner of the BIOS Starting Menu.

If the message disappears before the **DEL** or **F2** key is pressed, restart the computer and try again, then the BIOS Starting Menu will appear. Select "Setup" and press Enter to get into the BIOS Setup.

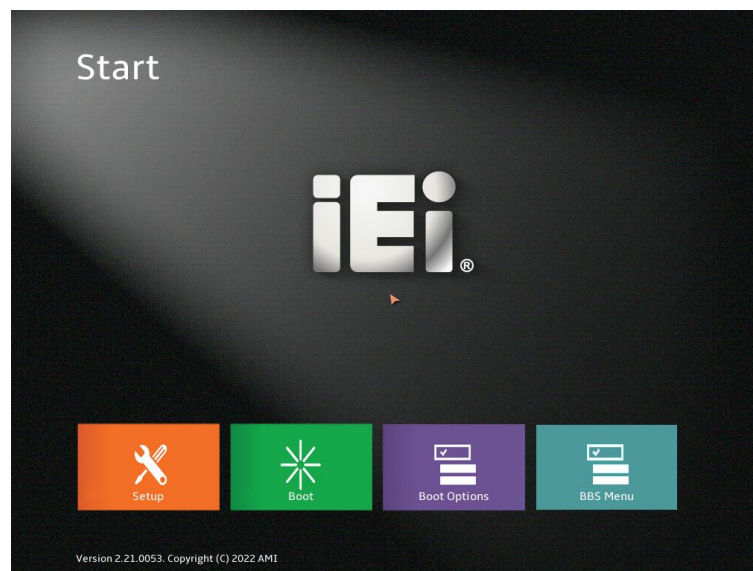

Figure 5-1: BIOS Starting Menu

5.1.2 Using Setup

The BIOS Setup menu can be navigated by using a keyboard or a touchscreen.

5.1.2.1 Keyboard Navigation

For keyboard navigation, use the navigation keys shown in (Figure 5-2).

Key	Function
Up arrow	Move to previous item
Down arrow	Move to next item
Left arrow	Move to the item on the left hand side
Right arrow	Move to the item on the right hand side
+	Increase the numeric value or make changes
-	Decrease the numeric value or make changes
Page Up	Move to the previous page
Page Dn	Move to the next page
Esc	Main Menu – Quit and not save changes into CMOS Status Page Setup Menu and Option Page Setup Menu -- Exit current page and return to Main Menu
F1	General help, only for Status Page Setup Menu and Option Page Setup Menu
F2	Load previous values
F3	Load optimized defaults
F4	Save changes and Exit BIOS
<K>	Scroll help area upwards
<M>	Scroll help area downwards

Figure 5-2: BIOS Navigation Keys

5.1.2.2 Touch Navigation

For touchscreen navigation, use the on-screen navigation keys shown below (Figure 5-3).

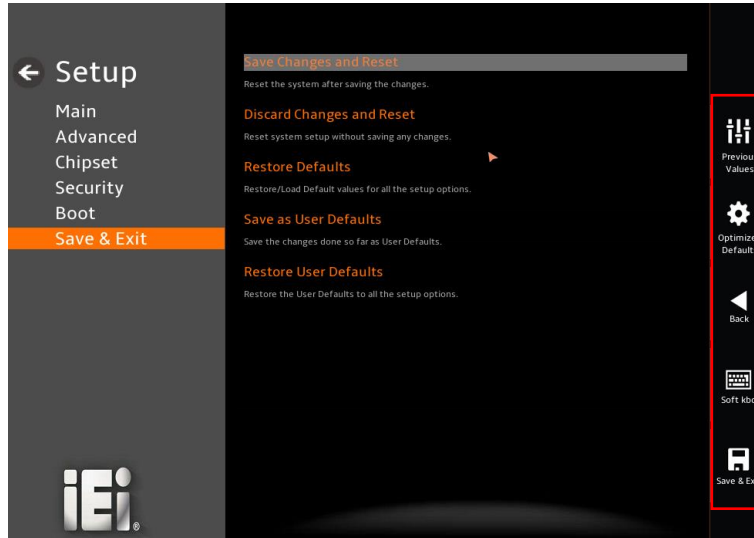

On-screen Button	Function
Previous Values	Load the last value you set.
Optimized Defaults	Load the factory default values in order to achieve the best performance.
Back	Return to the previous menu.
Soft kbd	Display the on-screen keyboard.
Save & Exit	Save the changes made to the BIOS options and reset the system.

Figure 5-3: BIOS On-screen Navigation Keys

5.1.3 Getting Help

When **F1** is pressed a small help window describing the appropriate keys to use and the possible selections for the highlighted item appears. To exit the Help Window, press the **Esc** key.

5.1.4 Unable to Reboot after Configuration Changes

If the computer cannot boot after changes to the system configuration is made, CMOS defaults. Use the clear CMOS button described in **Chapter 4**.

5.1.5 BIOS Menu Bar

The **menu bar** on top of the BIOS screen has the following main items:

- Main – Changes the basic system configuration.
- Advanced – Changes the advanced system settings.
- Chipset – Changes the chipset settings.
- Security – Sets User and Supervisor Passwords.
- Boot – Changes the system boot configuration.
- Save & Exit – Selects exit options and loads default settings

The following sections completely describe the configuration options found in the menu items at the top of the BIOS screen and listed above.

TANK-630-EHL

5.2 Main

The **Main** BIOS menu (**BIOS Menu 1 & BIOS Menu 2**) appears when the **BIOS Setup** program is entered. The **Main** menu gives an overview of the basic system information.

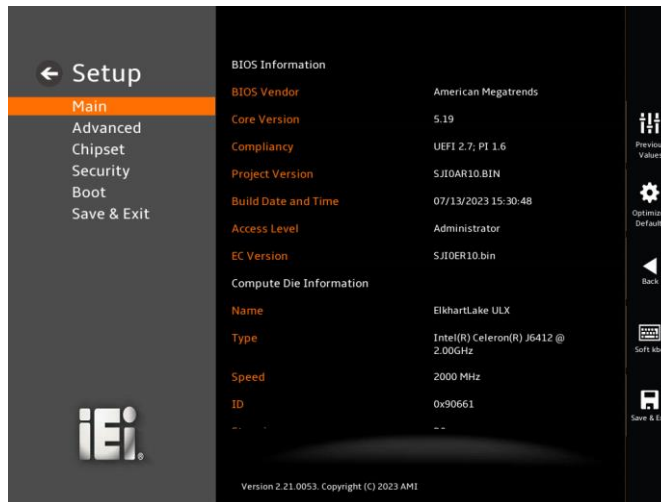

BIOS Menu 1: Main (1/2)

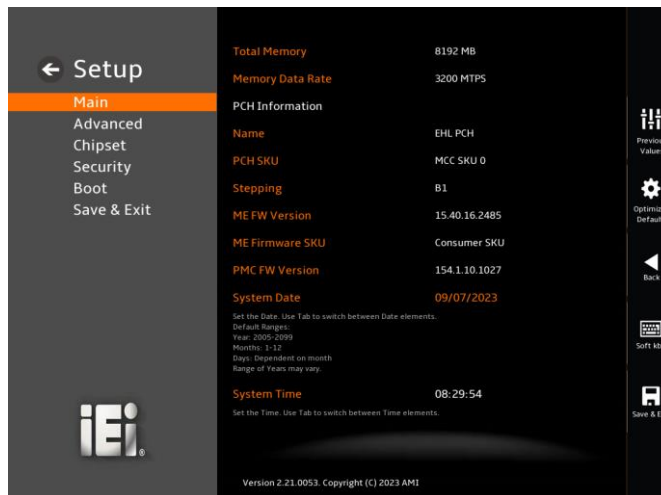

BIOS Menu 2: Main (2/2)

➔ BIOS Information

The **BIOS Information** lists a brief summary of the BIOS. The fields in **BIOS Information** cannot be changed. The items shown in the system overview include:

- **BIOS Vendor:** Installed BIOS vendor
- **Core Version:** Current BIOS version

- **Compliance:** Current UEFI & PI version
- **Project Version:** the board version
- **Build Date and Time:** Date the current BIOS version was made
- **Access Level:** Administrator
- **EC Version:** Current EC version

→ Compute Die Information

The **Processor Information** lists a brief summary of the Processor. The fields in **Processor Information** cannot be changed. The items shown in the system overview include:

- **Name:** Displays the Processor Details
- **Type:** Displays the Processor Type
- **Speed:** Displays the Processor Speed
- **ID:** Displays the Processor ID
- **Stepping:** Displays the Processor Stepping
- **Package:** Displays the Processor Package
- **Number of Processors:** Displays number of CPU cores
- **Microcode Revision:** CPU Microcode Revision
- **GT Info:** Processor GT info. Only valid if SNB stepping is D0 or above
- **IGFX GOP Version:** Displays the IGFX GOP Version
- **Total Memory:** Total Memory in the System
- **Memory Data Rate:** Displays the Rate of Memory Data

→ PCH Information

The **PCH Information** lists a brief summary of the PCH. The fields in **PCH Information** cannot be changed. The items shown in the system overview include:

- **Name:** Displays the PCH Name
- **PCH SKU:** Displays the PCH SKU
- **Stepping:** Displays the PCH Stepping
- **ME FW Version:** Displays the ME Firmware Version
- **ME Firmware SKU:** Displays the ME Firmware SKU
- **PMC FW Version:** Displays the PMC Firmware Version

The System Overview field also has two user configurable fields:

TANK-630-EHL

→ **System Date [xx:xx:xx]**

Use the **System Date** option to set the system date. Manually enter the day, month and year.

→ **System Time [xx:xx:xx]**

Use the **System Time** option to set the system time. Manually enter the hours, minutes and seconds.

5.3 Advanced

Use the **Advanced** menu (**BIOS Menu 3**) to configure the CPU and peripheral devices through the following sub-menus



WARNING!

Setting the wrong values in the sections below may cause the system to malfunction. Make sure that the settings made are compatible with the hardware.

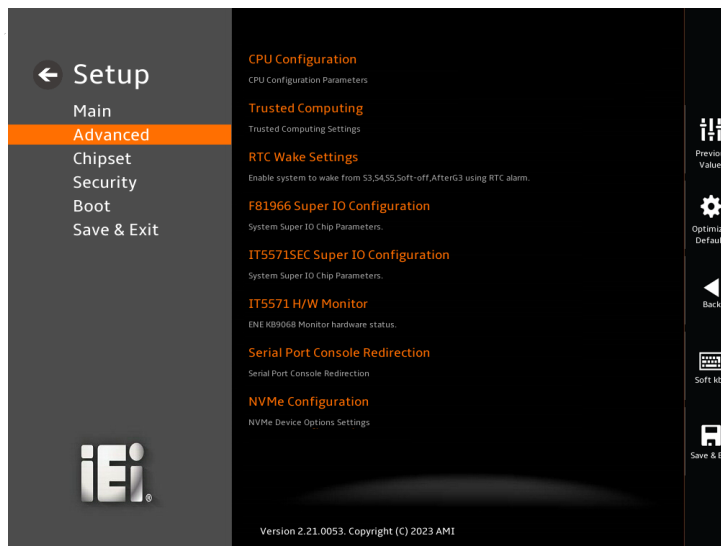

BIOS Menu 3: Advanced

TANK-630-EHL

5.3.1 CPU Configuration

Use the **CPU Configuration** menu (**BIOS Menu 4 & BIOS Menu 5 & BIOS Menu 6**) to view detailed CPU specifications or enable the Intel Virtualization Technology.



BIOS Menu 4: CPU Configuration (1/3)



BIOS Menu 5: CPU Configuration (2/3)



BIOS Menu 6: CPU Configuration (3/3)

➔ **Active Processor Cores [ALL]**

Use the **Active Processor Cores** BIOS option to enable numbers of P-cores in the processor package.

- ➔ **All** **DEFAULT** Enable all cores in the processor package.
- ➔ **1** Enable one core in the processor package.
- ➔ **2** Enable two cores in the processor package.
- ➔ **3** Enable three cores in the processor package.

➔ **EIST [Enabled]**

Use the **EIST** option to enable or disable the capability that allows more than two frequency ranges to be supported.

- ➔ **Disabled** Disables the EIST Technology
- ➔ **Enabled** **DEFAULT** Enables the EIST Technology

➔ **Turbo Mode [Enabled]**

Use the **Turbo Mode** option to enable or disable Turbo Mode which requires Intel Speed Step or Intel Speed Shift to be available and enabled.

- ➔ **Disabled** Disables Turbo Mode Technology

TANK-630-EHL

→ **Enabled** **DEFAULT** Enables Turbo Mode Technology

→ **C states [Disabled]**

Use the **C states** option to enable or disable the CPU Power Management.

→ **Disabled** **DEFAULT** Disables CPU to go to C states when it's not 100% utilized.

→ **Enabled** Enables CPU to go to C states when it's not 100% utilized.

→ **Intel (VMX) Virtualization Technology [Disabled]**

Use the **Intel (VMX) Virtualization Technology** option to enable or disable virtualization on the system. When combined with third party software, Intel® Virtualization technology allows several OSs to run on the same system at the same time.

→ **Disabled** Disables Intel Virtualization Technology.

→ **Enabled** **DEFAULT** Enables Intel Virtualization Technology.

→ **Active Processor Cores [All]**

Use the **Active Processor Cores** BIOS option to enable numbers of cores in the processor package.

→ **All** **DEFAULT** Enable all cores in the processor package.

→ **1** Enable one core in the processor package.

→ **2** Enable two cores in the processor package.

→ **3** Enable three cores in the processor package.

→ **Power Limit 1**

Use the Power Limit 1 to set Power Limit in Milli Watts. BIOS will round to the nearest 1/8W when programming. 0 = no custom override. For 12.50W, enter 12500. Overclocking SKU: Value must be between Max and Min Power Limits. Other SKUs: This value must be between Min Power limit and TDP Limit. If value is 0, BIOS will program TDP value.

→ **Power Limit 1 Time Window**

Power Limit 1 Time Window value in second. The value may vary from 0 to 128.0, 0 = default value (28 sec for mobile and 8 sec for desktop). Defines time window which TDP value should be maintained.

→ **Power Limit 2**

Use the Power Limit 2 to set Power Limit in Milli Watts. BIOS will round to the nearest 1/8W when programming. If the value is 0, BIOS will program this value as $1.25 * TDP$. For 12.50W, enter 12500. Processor applies control policies such that the package power does not exceed this limit.

5.3.2 Trusted Computing

The **Trusted Computing** menu (**BIOS Menu 7**) to configure settings related to the Trusted Computing Group (TCG) Trusted Platform Module (TPM).

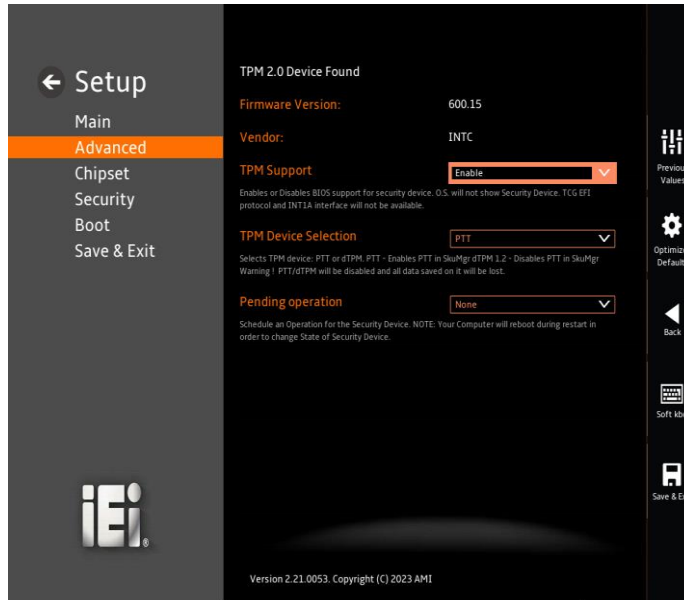

BIOS Menu 7: Trusted Computing

➔ **TPM Support [Enable]**

Use the Security Device Support option to configure support for the Security Device.

- ➔ **Disable** Security Device support is disabled.
- ➔ **Enable** **DEFAULT** Security Device is enabled.

➔ **TPM Device Selection [PTT]**

Use the **Pending Operation** option to schedule an operation for the security device.

- ➔ **None** **DEFAULT** TPM information is previous.
- ➔ **TPM Clear** TPM information is cleared

➔ **Pending operation [None]**

Use the **Pending Operation** option to schedule an operation for the security device.

- **None** **DEFAULT** TPM information is previous.
- **TPM Clear** TPM information is cleared

5.3.3 RTC Wake Settings

The **RTC Wake Settings** menu (**BIOS Menu 8 & BIOS Menu 9**) configures RTC wake event.

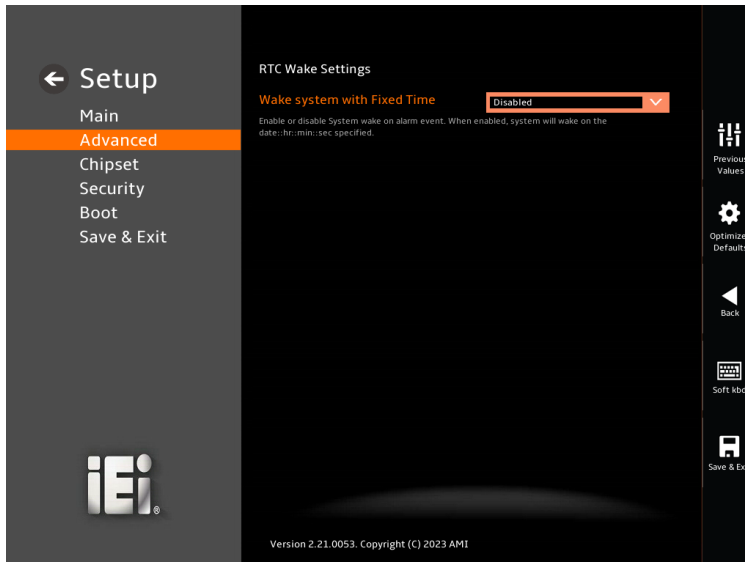

BIOS Menu 8: RTC Wake Settings (1/2)

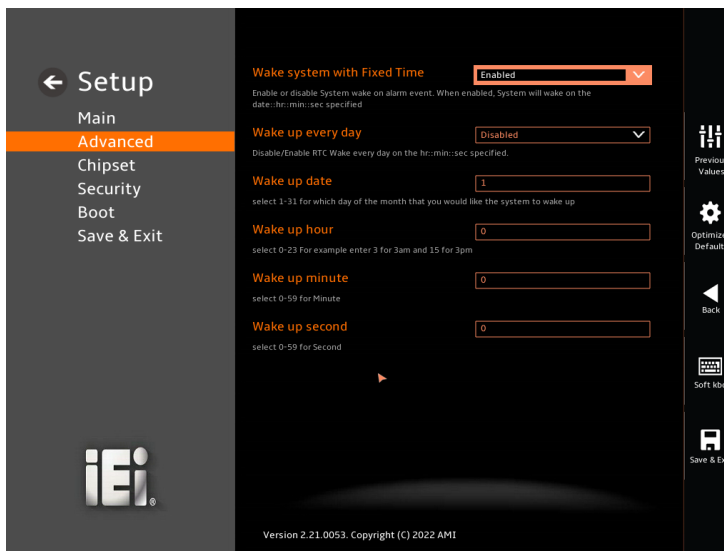

BIOS Menu 9: RTC Wake Settings (2/2)

➔ **Wake system with Fixed Time [Disabled]**

Use the **Wake system with Fixed Time** option to enable or disable the system wake on alarm event.

→ **Disabled** **DEFAULT** The real time clock (RTC) cannot generate a wake event

→ **Enabled** If selected, the **Wake up every day** option appears allowing you to enable to disable the system to wake every day at the specified time. Besides, the following options appear with values that can be selected:

Wake up date

Wake up hour

Wake up minute

Wake up second

After setting the alarm, the computer turns itself on from a suspend state when the alarm goes off.

TANK-630-EHL

5.3.4 F81966 Super IO Configuration

Use the **F81966 Super IO Configuration** menu (**BIOS Menu 10**) to set or change the configurations for the serial ports.

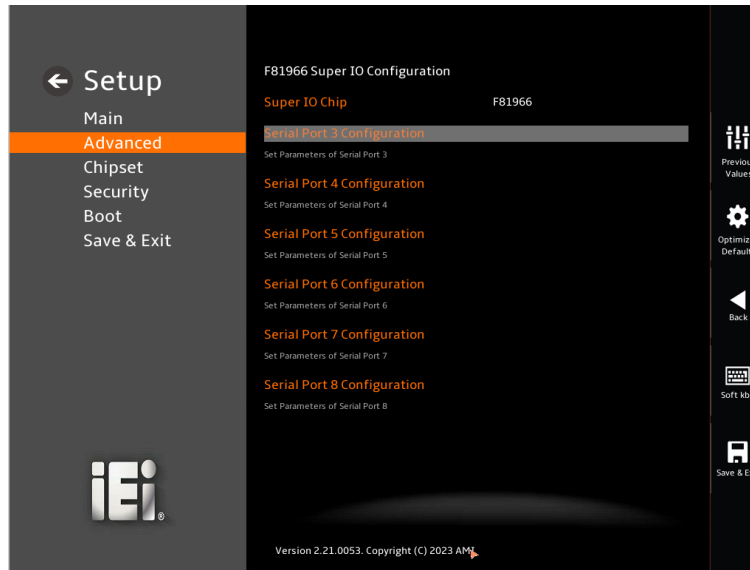

BIOS Menu 10: F81966 Super IO Configuration

5.3.4.1 Serial Port 3 Configuration

Use the **Serial Port 3 Configuration** menu (**BIOS Menu 11**) to configure the serial port 3

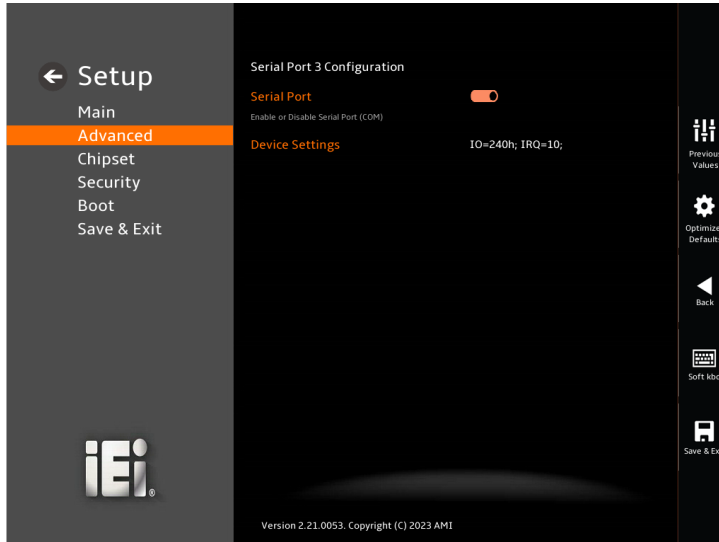

BIOS Menu 11: Serial Port 3 Configuration Menu

➔ Serial Port [Enabled]

Use the **Serial Port** option to enable or disable the serial port.

- ➔ **Disabled** Disable the serial port
- ➔ **Enabled** **DEFAULT** Enable the serial port

➔ Device Settings

The **Device Settings** option shows the serial port IO port address and interrupt address.

- ➔ **IO=240h;** Serial Port I/O port address is 240h and the interrupt
IRQ=10 address is IRQ10

TANK-630-EHL

5.3.4.2 Serial Port 4 Configuration

Use the **Serial Port 4 Configuration** menu (**BIOS Menu 12**) to configure the serial port 4

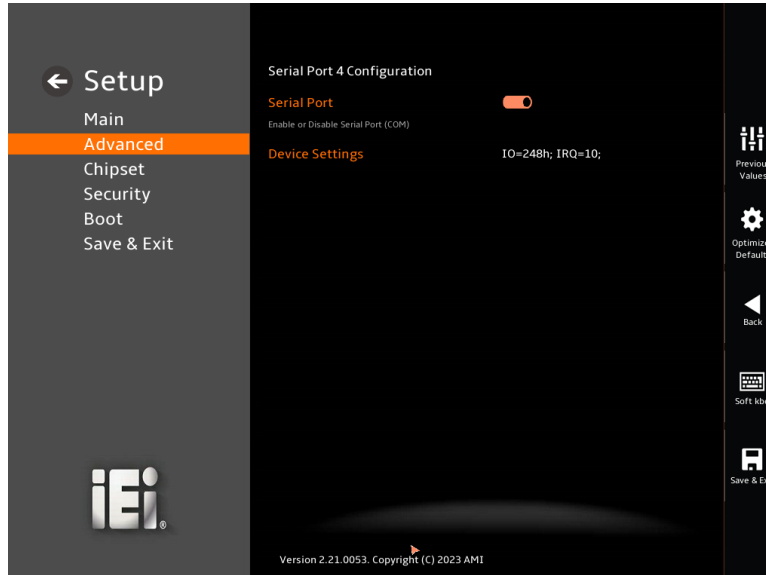

BIOS Menu 12: Serial Port 4 Configuration Menu

→ **Serial Port [Enabled]**

Use the **Serial Port** option to enable or disable the serial port.

- **Disabled** Disable the serial port
- **Enabled DEFAULT** Enable the serial port

→ **Device Settings**

The **Device Settings** option shows the serial port IO port address and interrupt address.

- **IO=248h;** Serial Port I/O port address is 248h and the interrupt
IRQ=10 address is IRQ10

5.3.4.3 Serial Port 5 Configuration

Use the **Serial Port 5 Configuration** menu (**BIOS Menu 13**) to configure the serial port 5

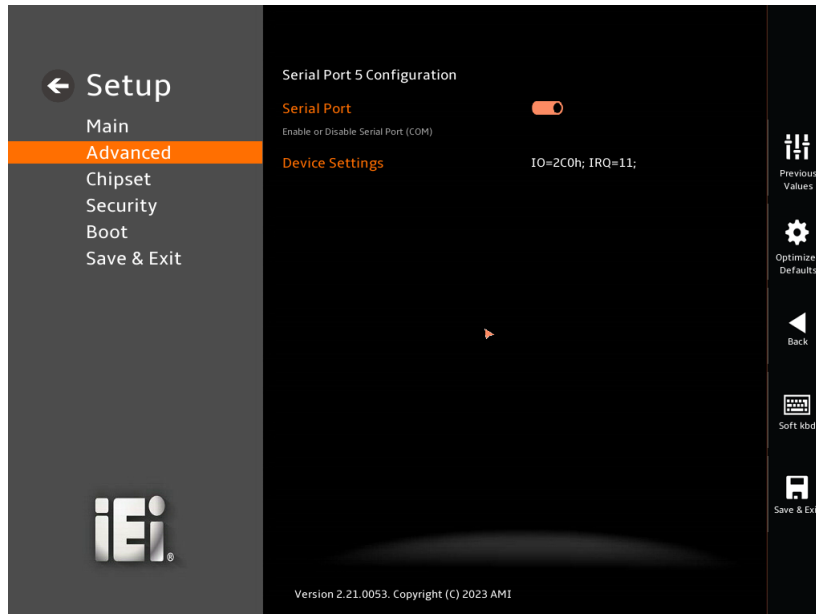

BIOS Menu 13: Serial Port 5 Configuration Menu

➔ Serial Port [Enabled]

Use the **Serial Port** option to enable or disable the serial port.

- ➔ **Disabled** Disable the serial port
- ➔ **Enabled DEFAULT** Enable the serial port

➔ Device Settings

The **Device Settings** option shows the serial port IO port address and interrupt address.

- ➔ **IO=2C0h;** Serial Port I/O port address is 2C0h and the interrupt
IRQ=11 address is IRQ11

5.3.4.5 Serial Port 7 Configuration

Use the **Serial Port 7 Configuration** menu (**BIOS Menu 15**) to configure the serial port 7

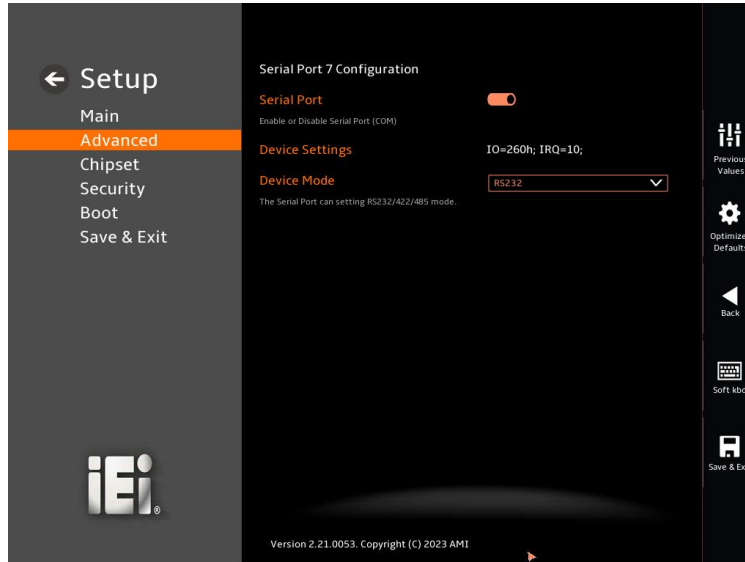

BIOS Menu 15: Serial Port 7 Configuration Menu

→ Serial Port [Enabled]

Use the **Serial Port** option to enable or disable the serial port.

- **Disabled** Disable the serial port
- **Enabled DEFAULT** Enable the serial port

→ Device Settings

The **Device Settings** option shows the serial port IO port address and interrupt address.

- **IO=260h;** Serial Port I/O port address is 260h and the interrupt
IRQ=10 address is IRQ10

→ Device Mode

Use the **Device Mode** option to change the serial port mode.

- **RS232** Serial Port Mode is RS232 mode

TANK-630-EHL

- ➔ **RS422** Serial Port Mode is RS422 mode
- ➔ **RS485** Serial Port Mode is RS485 mode

5.3.4.6 Serial Port 8 Configuration

Use the **Serial Port 8 Configuration** menu (**BIOS Menu 16**) to configure the serial port 8.

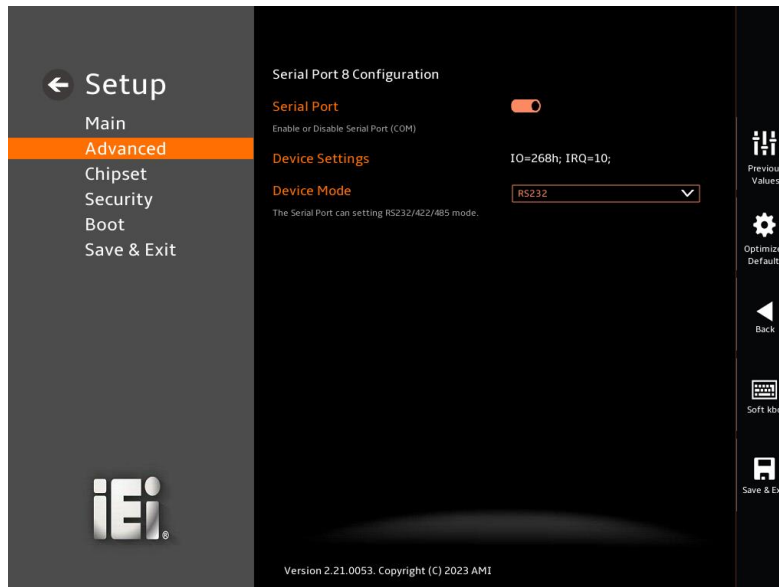

BIOS Menu 16: Serial Port 8 Configuration Menu

➔ **Serial Port [Enabled]**

Use the **Serial Port** option to enable or disable the serial port.

- ➔ **Disabled** Disable the serial port
- ➔ **Enabled** **DEFAULT** Enable the serial port

➔ **Device Settings**

The Device Settings option shows the serial port IO port address and interrupt address.

→ IO=268h;
IRQ=10

Serial Port I/O port address is 268h and the interrupt address is IRQ10

→ **Device Mode**

Use the **Device Mode** option to change the serial port mode.

→ RS232

Serial Port Mode is RS232 mode

→ RS422

Serial Port Mode is RS422 mode

→ RS485

Serial Port Mode is RS485 mode

TANK-630-EHL

5.3.5 IT5571SEC Super IO Configuration

Use the **IT5571SEC Super IO Configuration** menu (**BIOS Menu 17**) to set or change the configurations for the serial ports.



BIOS Menu 17: IT5571 Super IO Configuration

5.3.5.1 Serial Port 1 Configuration

Use the **Serial Port 1 Configuration** menu (**BIOS Menu 18**) to configure the serial port n.

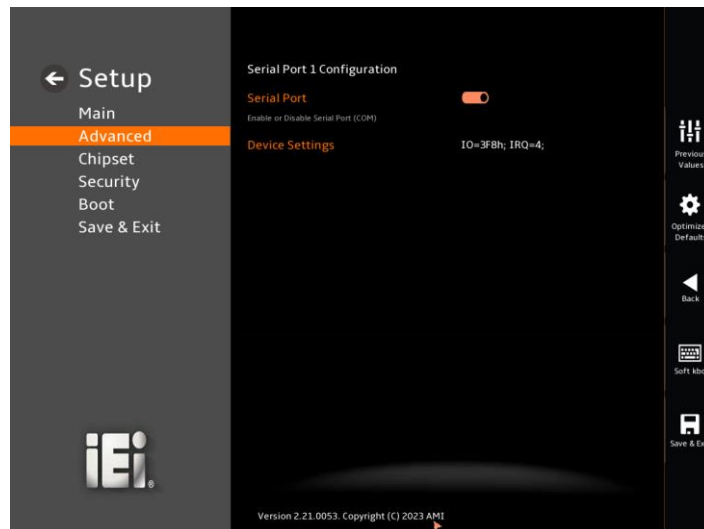

BIOS Menu 18: Serial Port 1 Configuration Menu

TANK-630-EHL

→ Device Settings

The Device Settings option shows serial port IO port address and interrupt address.

- **IO=2F8h;** Serial Port I/O port address is 2F8h and the interrupt
IRQ=3 address is IRQ3

5.3.6 IT5571 H/W Monitor

The **IT5571 H/W Monitor** menu (**BIOS Menu 20**) contains the state of H/W real-time operating temperature and system voltages

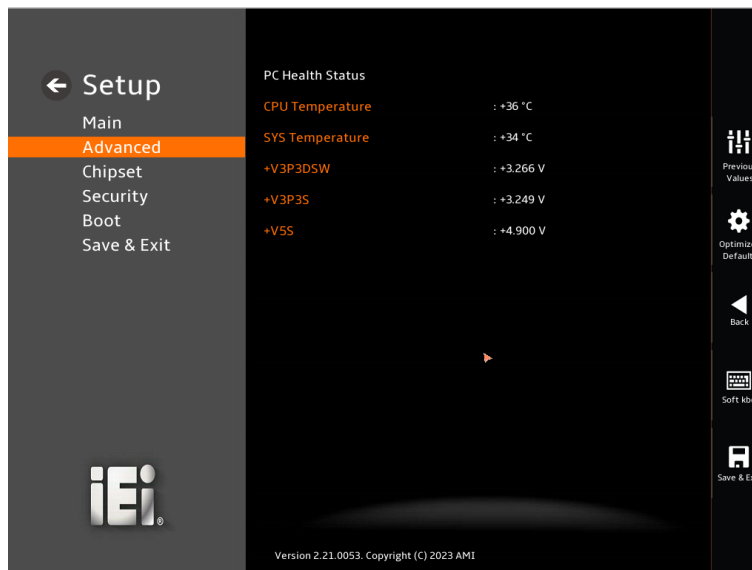

BIOS Menu 20: IT5571 H/W Monitor

→ PC Health Status

The following system parameters and values are shown. The system parameters that are monitored are:

- CPU Temperature
- System Temperature
- +V3P3DSW
- +V3P3S
- +V5S

5.3.7 Serial Port Console Redirection

The **Serial Port Console Redirection** menu (**BIOS Menu 21**) allows the console redirection options to be configured. Console Redirection allows users to maintain a system remotely by re-directing keyboard input and text output through the serial port.

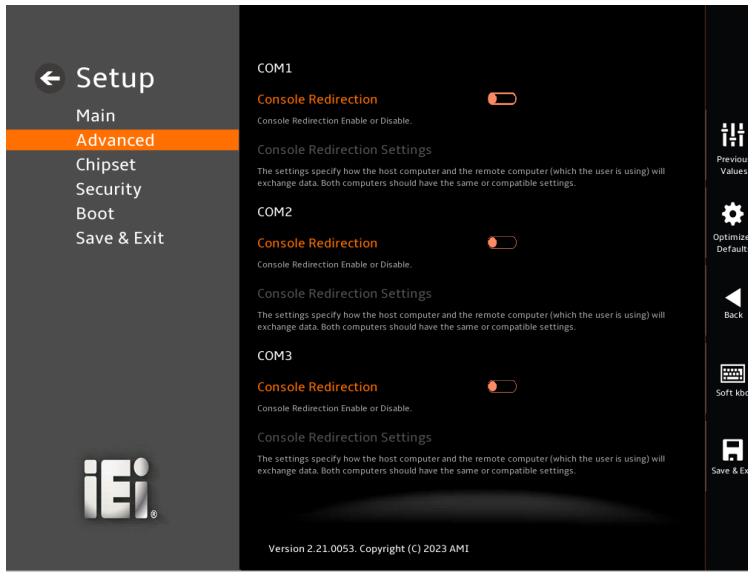

BIOS Menu 21:Serial Port Console Redirection

➔ **Console Redirection [Disabled]**

Use **Console Redirection** option to enable or disable the console redirection function.

- ➔ **Disabled** **DEFAULT** Disabled the console redirection function.
- ➔ **Enabled** Enabled the console redirection function.

The **Console Redirection Settings** submenu will be available when the **Console Redirection** option is enabled.

5.3.7.1 Console Redirection Settings

The following options are available in the **Console Redirection Settings** submenu (**BIOS Menu 22**) when the **COM Console Redirection (for COM1 to COM8)** option is enabled.

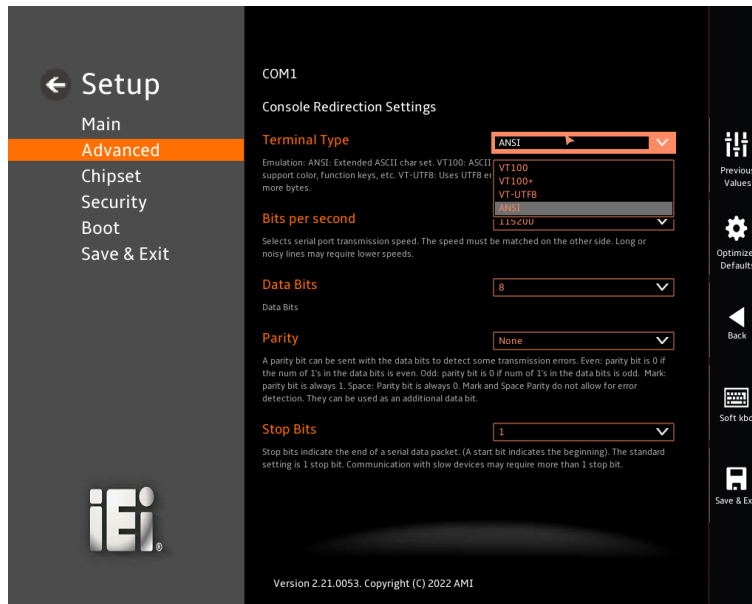

BIOS Menu 22: COM Console Redirection Settings

→ Terminal Type [ANSI]

Use the **Terminal Type** option to specify the remote terminal type.

- **VT100** The target terminal type is VT100
- **VT100+** The target terminal type is VT100+
- **VT-UTF8** The target terminal type is VT-UTF8
- **ANSI** **DEFAULT** The target terminal type is ANSI

→ Bits per second [115200]

Use the **Bits per second** option to specify the serial port transmission speed. The speed must match on the other side. Long or noisy lines may require lower speeds.

- **9600** Sets the serial port transmission speed at 9600.
- **19200** Sets the serial port transmission speed at 19200.
- **38400** Sets the serial port transmission speed at 38400.
- **57600** Sets the serial port transmission speed at 57600.

→ 115200 DEFAULT Sets the serial port transmission speed at 115200.

→ **Data Bits [8]**

Use the **Data Bits** option to specify the number of data bits.

→ 7 Sets the data bits at 7.

→ 8 DEFAULT Sets the data bits at 8.

→ **Parity [None]**

Use the **Parity** option to specify the parity bit that can be sent with the data bits for detecting the transmission errors.

→ **None** DEFAULT No parity bit is sent with the data bits.

→ **Even** The parity bit is 0 if the number of ones in the data bits is even.

→ **Odd** The parity bit is 0 if the number of ones in the data bits is odd.

→ **Mark** The parity bit is always 1. This option does not allow for error detection.

→ **Space** The parity bit is always 0. This option does not allow for error detection.

→ **Stop Bits [1]**

Use the **Stop Bits** option to specify the number of stop bits used to indicate the end of a serial data packet. Communication with slow devices may require more than 1 stop bit.

→ 1 DEFAULT Sets the number of stop bits at 1.

→ 2 Sets the number of stop bits at 2.

TANK-630-EHL

5.3.8 NVMe Configuration

Use the **NVMe Configuration (BIOS Menu 23)** menu to display the NVMe controller.

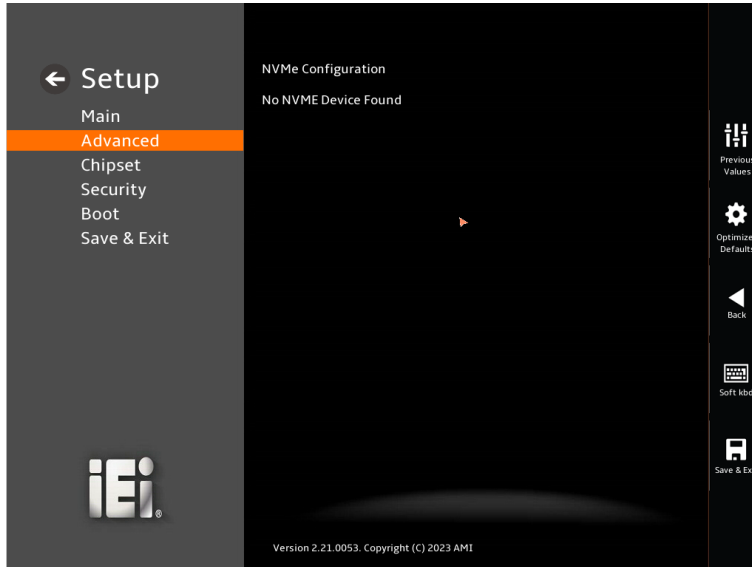

BIOS Menu 23: NVMe configuration

5.4 Chipset

Use the **Chipset** menu (**BIOS Menu 24**) to access the PCH IO and System Agent (SA) configuration menus.



WARNING!

Setting the wrong values for the Chipset BIOS selections in the Chipset BIOS menu may cause the system to malfunction.

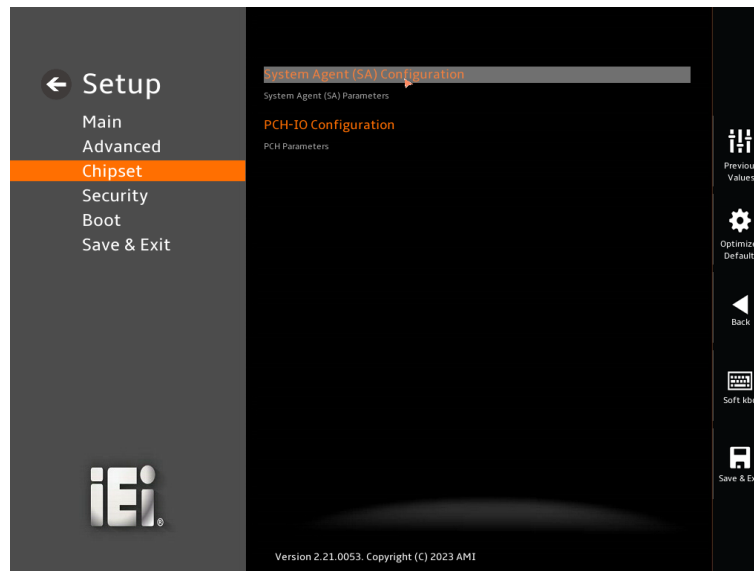

BIOS Menu 24: Chipset

5.4.1 System Agent (SA) Configuration

Use the **System Agent (SA) Configuration** menu (**BIOS Menu 25**) to configure the System Agent (SA) parameters.

TANK-630-EHL

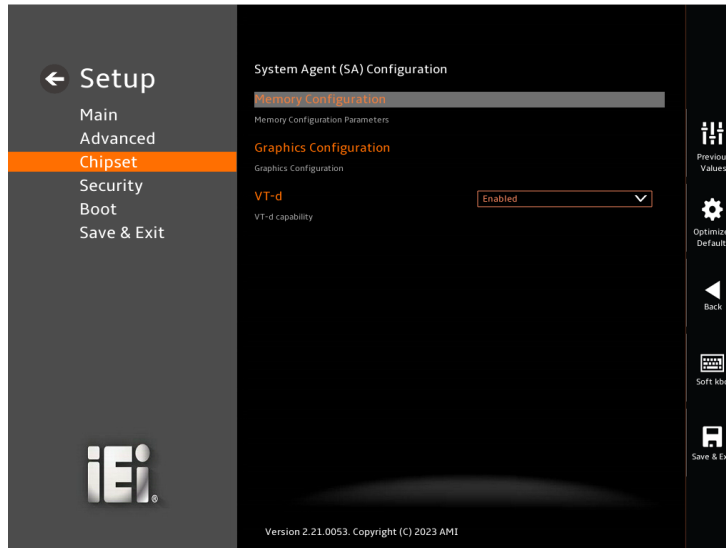

BIOS Menu 25: System Agent (SA) Configuration

→ **VT-d [Enabled]**

Use the **VT-d** option to enable or disable the VT-d capability.

- **Disabled** Disable the VT-d capability
- **Enabled** **DEFAULT** Enable the VT-d capability

5.4.1.1 Memory Configuration

Use the **Memory Configuration** submenu (**BIOS Menu 26**) to view memory information.

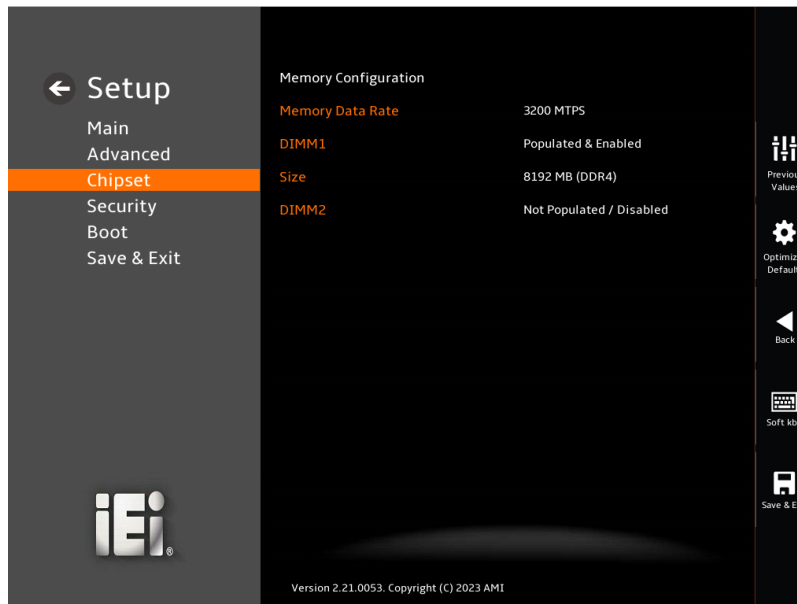

BIOS Menu 26: Memory Configuration

5.4.1.2 Graphics Configuration

Use the **Graphics Configuration (BIOS Menu 27)** menu to configure the video device connected to the system.

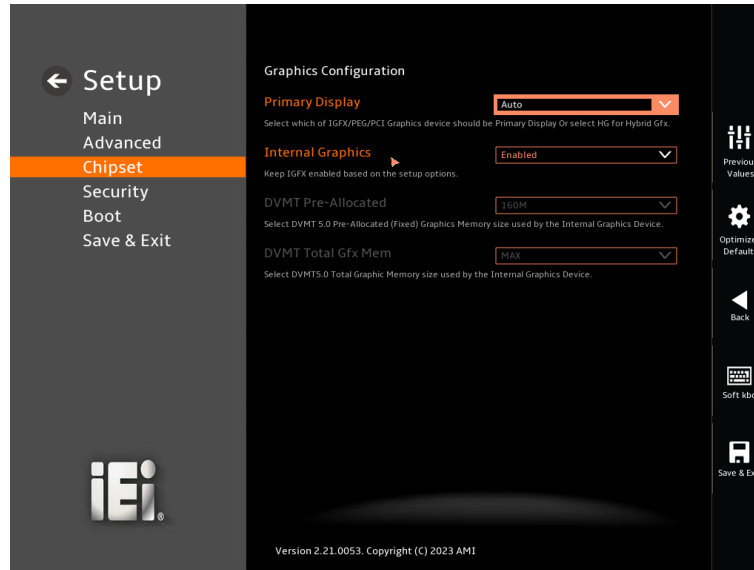

BIOS Menu 27: Graphics Configuration

→ Primary Display [Auto]

Use the **Primary Display** option to select the primary graphics controller the system uses. The following options are available:

- Auto **DEFAULT**
- IGFX
- PEG
- PCI

→ Internal Graphics [Enabled]

Use the **Internal Graphics** option to configure whether to keep IGFX enabled. If user wants to support dual display by internal graphics and external graphics, this Internal Graphics option should be set to Enabled and the above Primary Display option should be set to IGFX.

- **Auto** Auto mode
- **Disabled** Disables IGFX.

- ➔ **Enabled** **DEFAULT** Enables IGFX.

5.4.2 PCH-IO Configuration

Use the **PCH-IO Configuration** menu (**BIOS Menu 28**) to configure the PCH parameters.



BIOS Menu 28: PCH-IO Configuration

➔ **Auto Power Button Function [Disabled (ATX)]**

Use the **Auto Power Button Function** BIOS option to show the power mode state. Use the **J_ATX_AT1** to switch the AT/ATX power mode.

- ➔ **Enabled (AT)** The system power mode is AT.
- ➔ **Disabled (ATX)** The system power mode is ATX.

➔ **Restore AC Power Loss [Last State]**

Use the **Restore AC Power Loss** BIOS option to specify what state the system returns to if there is a sudden loss of power to the system when the power mode is ATX.

- ➔ **Power Off** The system remains turned off
- ➔ **Power On** The system turns on

TANK-630-EHL

→ **Last State** **DEFAULT** The system returns to its previous state. If it was on, it turns itself on. If it was off, it remains off.

→ **Power Saving Function (EUP) [Disabled]**

Use the **Power Saving Function (EUP)** BIOS option to enable or disable the power saving function.

→ **Disabled** **DEFAULT** Power saving function is disabled.

→ **Enabled** Power saving function is enabled. It will reduce power consumption when the system is off.

→ **LAN1_USB1/LAN2_USB2 Power SW1 [+5V DUAL]**

Use the **LAN1_USB1/LAN2_USB2 Power SW1** BIOS option to configure the USB power source for the corresponding USB connectors (Figure 5-4).

→ **+5V DUAL** **DEFAULT** Sets the USB power source to +5V dual

→ **+5V** Sets the USB power source to +5V

→ **LAN3_USB3/JUSB4 Power SW2 [+5V DUAL]**

Use the **LAN3_USB3/JUSB4 Power SW2** BIOS option to configure the USB power source for the corresponding USB connectors (Figure 5-4).

→ **+5V DUAL** **DEFAULT** Sets the USB power source to +5V dual

→ **+5V** Sets the USB power source to +5V

BIOS Options	Configured LAN_USB Ports
LAN1_USB1/LAN2_USB2 Power SW1	USB_CN1 external USB 2.0 ports
LAN3_USB3/JUSB4 Power SW2	USB_CN2 external USB 3.2 Gen2 ports

Figure 5-4: BIOS Options and Configured LAN_USB Ports

5.4.2.1 PCI Express Configuration

Use the **PCI Express Configuration** submenu (**BIOS Menu 29**) to configure the PCI Express slots.

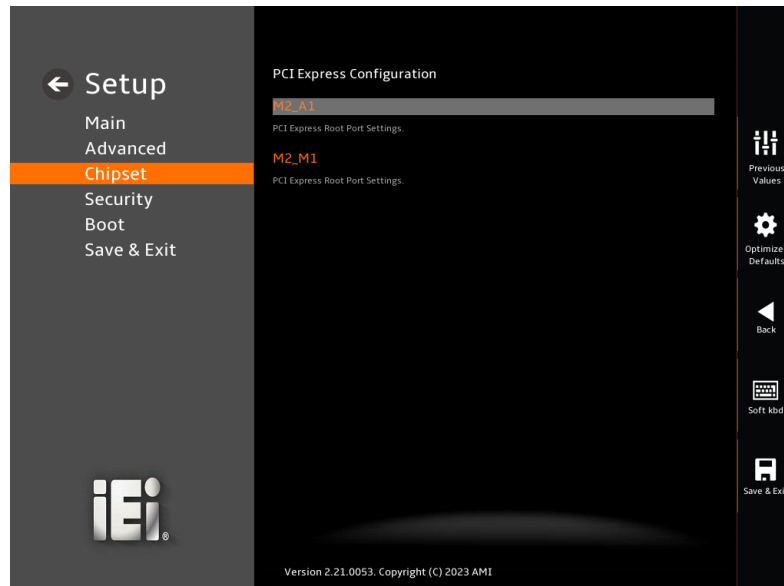

BIOS Menu 29: PCI Express Configuration

TANK-630-EHL

5.4.2.2 PCI Express Root Port Setting

Use the **M2_A1** and **M.2_M1** submenu (BIOS Menu 30 & BIOS Menu 31) to configure the PCI Root Port Setting.

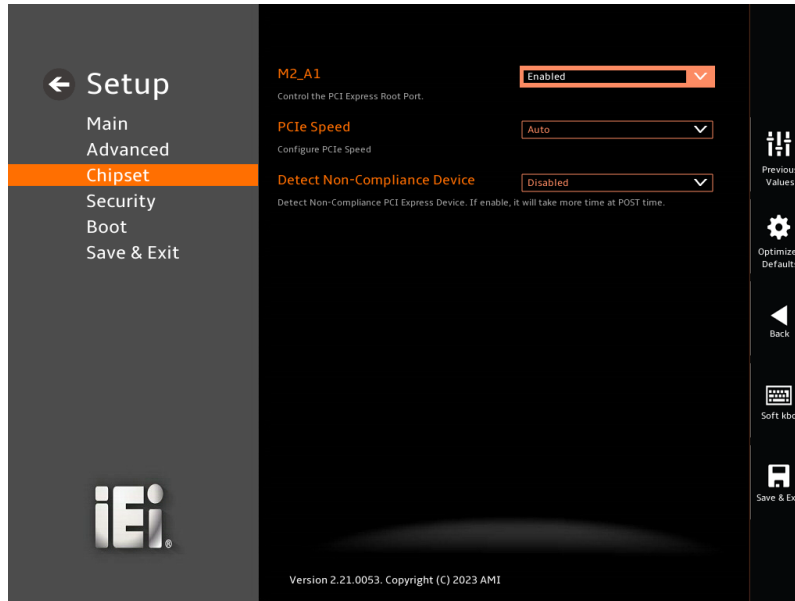

BIOS Menu 30: PCIe Slot Configuration Submenu (1/2)



BIOS Menu 31: PCIe Slot Configuration Submenu (2/2)

→ PCIe Speed [Auto]

Use the **PCIe Speed** option to specify the PCI Express port speed. Configuration options are listed below.

- | | | |
|---------------|----------------|-------------------------------|
| → Auto | DEFAULT | Auto mode. |
| → Gen1 | | Configure PCIe Speed to Gen1. |
| → Gen2 | | Configure PCIe Speed to Gen2. |
| → Gen3 | | Configure PCIe Speed to Gen3. |

→ Detect Non-Compliance Device [Disabled]

Use the **Detect Non-Compliance Device** option to configure whether to detect if a non-compliance PCI Express device is connected to the PCI Express port.

- | | | |
|-------------------|----------------|--|
| → Disabled | DEFAULT | Do not detect if a non-compliance PCI Express device is connected to the PCI Express port. |
| → Enabled | | Detect if a non-compliance PCI Express device is connected to the PCI Express port. |

5.4.2.3 SATA Configuration

Use the **SATA Configuration** menu (**BIOS Menu 32**) to change and/or set the configuration of the SATA devices installed in the system.

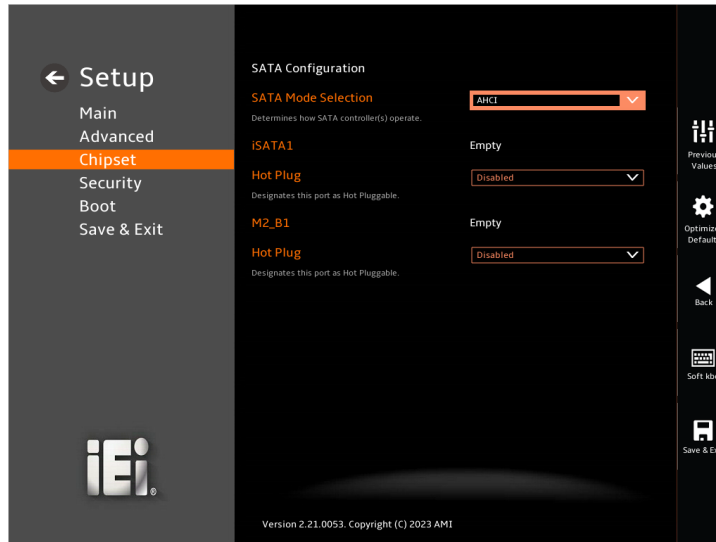

BIOS Menu 32: SATA Configuration

→ SATA Mode Selection [AHCI]

Use the **SATA Mode Selection** option to determine how the SATA devices operate.

→ **AHCI** **DEFAULT** Configures SATA devices as AHCI device.

→ Hot Plug [Disabled]

Use the **Hot Plug** option to designate the correspondent port as hot-pluggable.

→ **Disabled** **DEFAULT** Disables the hot-pluggable function of the SATA port.

→ **Enabled** Designate the SATA port as hot-pluggable

5.4.2.4 HD Audio Configuration

Use the **HD Audio Configuration** menu (**BIOS Menu 33**) to configure the PCH Azalia settings.

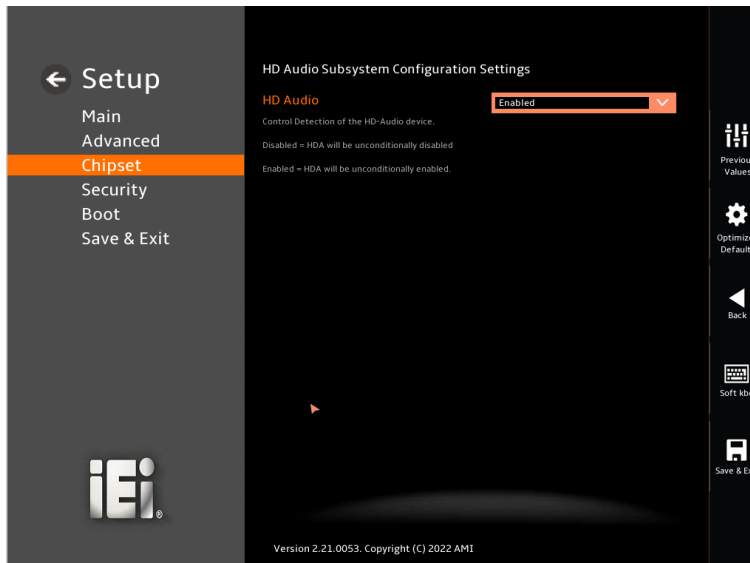

BIOS Menu 33: HD Audio Configuration

➔ HD Audio [Enabled]

Use the **HD Audio** option to enable or disable the High Definition Audio controller.

- ➔ **Disabled** The onboard High Definition Audio controller is disabled.
- ➔ **Enabled** **DEFAULT** The onboard High Definition Audio controller is enabled.

TANK-630-EHL

5.5 Security

Use the **Security** menu (**BIOS Menu 34**) to set system and user passwords.



BIOS Menu 34: Security

➔ Administrator Password

Use the **Administrator Password** to set or change an administrator password.

➔ User Password

Use the **User Password** to set or change a user password.

5.6 Boot

Use the **Boot** menu (**BIOS Menu 35**) to configure system boot options.

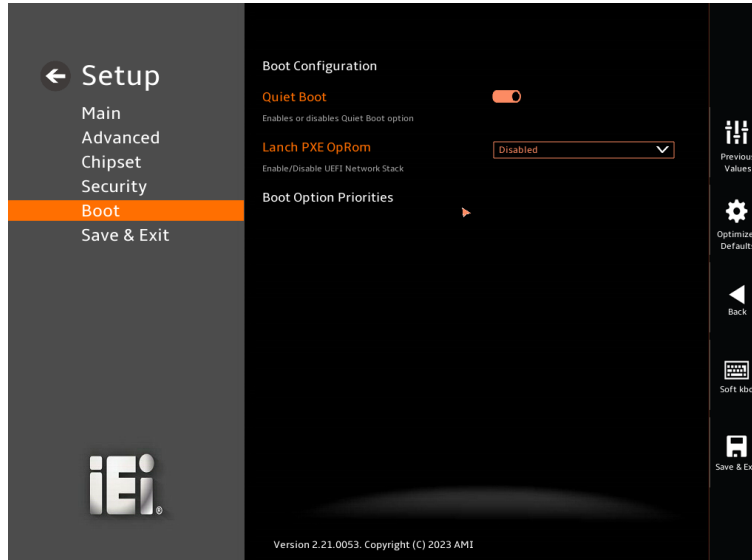

BIOS Menu 35: Boot

5.6.1 Boot Configuration

→ Quiet Boot [Enabled]

Use the **Quiet Boot** BIOS option to select the screen display when the system boots.

- **Disabled** Normal POST messages displayed
- **Enabled** **DEFAULT** OEM Logo displayed instead of POST messages

→ Launch PXE OpROM [Disabled]

Use the **Launch PXE OpROM** option to enable or disable boot option for legacy network devices.

- **Disabled** **DEFAULT** Ignore all PXE Option ROMs
- **Enabled** Load PXE Option ROMs.

TANK-630-EHL

5.6.2 Boot Option Priorities

Use the Boot Option # N to choose the system boots from the peripherals you selected
The following Boot Options are listed as an example.

→ **Boot Option #1**

Sets the system boot order **ADATA SP580** as the first priority.

→ **Windows Boot Manager (P1: ADATA SSD SP580 240GB)**

→ **Disabled**

→ **Boot Option #2**

Sets the system boot order **USB Partition 1** as the second priority.

→ **UEFI: USB, Partition 1**

→ **Disabled**

5.7 Save & Exit

Use the **Save & Exit** menu (**BIOS Menu 36**) to load default BIOS values, optimal failsafe values and to save configuration changes.

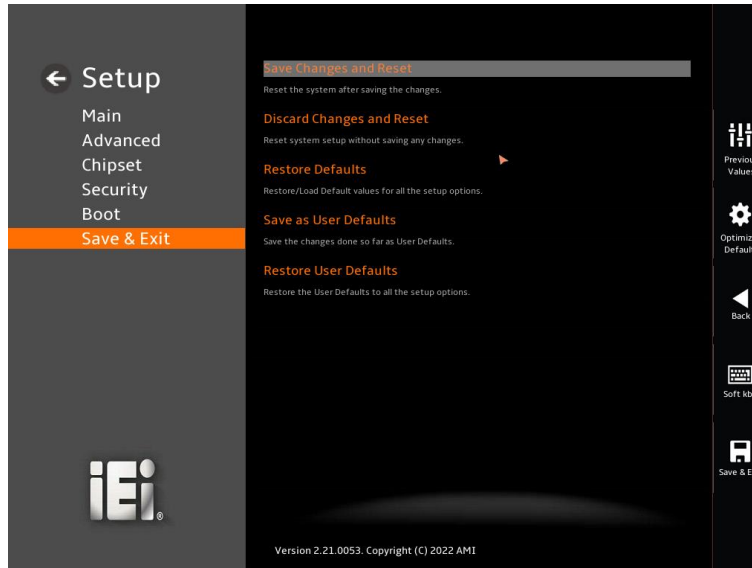

BIOS Menu 36: Save & Exit

→ Save Changes and Reset

Use the **Save Changes and Reset** option to save the changes made to the BIOS options and reset the system.

→ Discard Changes and Reset

Use the **Discard Changes and Reset** option to exit the system without saving the changes made to the BIOS configuration setup program.

→ Restore Defaults

Use the **Restore Defaults** option to load the optimal default values for each of the parameters on the Setup menus. **F3 key can be used for this operation.**

→ Save as User Defaults

Use the **Save as User Defaults** option to save the changes done so far as user defaults.

TANK-630-EHL

→ Restore User Defaults

Use the **Restore User Defaults** option to restore the user defaults to all the setup options.

Appendix

A

Safety Precautions

TANK-630-EHL

A.1 Safety Precautions



WARNING:

The precautions outlined in this appendix should be strictly followed. Failure to follow these precautions may result in permanent damage to the TANK-630-EHL Series.

Please follow the safety precautions outlined in the sections that follow:

A.1.1 General Safety Precautions

Please ensure the following safety precautions are adhered to at all times.

- ***Make sure the power is turned off and the power cord is disconnected*** when moving, installing or modifying the system.
- ***Do not apply voltage levels that exceed the specified voltage range.*** Doing so may cause fire and/or an electrical shock.
- ***Electric shocks can occur*** if opened while still powered on.
- ***Do not drop or insert any objects*** into the ventilation openings.
- ***If considerable amounts of dust, water, or fluids enter the system***, turn off the power supply immediately, unplug the power cord, and contact the system vendor.
- ***This equipment is not suitable for use in locations where children are likely to be present.***
- **DO NOT:**
 - Drop the system against a hard surface.
 - In a site where the ambient temperature exceeds the rated temperature

A.1.2 Anti-static Precautions

**WARNING:**

Failure to take ESD precautions during the installation of the TANK-630-EHL Series may result in permanent damage to the TANK-630-EHL Series and severe injury to the user.

Electrostatic discharge (ESD) can cause serious damage to electronic components, including the TANK-630-EHL Series. Dry climates are especially susceptible to ESD. It is therefore critical that whenever the TANK-630-EHL Series is opened and any of the electrical components are handled, the following anti-static precautions are strictly adhered to.

- ***Wear an anti-static wristband:*** Wearing a simple anti-static wristband can help to prevent ESD from damaging any electrical component.
- ***Self-grounding:*** Before handling any electrical component, touch any grounded conducting material. During the time the electrical component is handled, frequently touch any conducting materials that are connected to the ground.

Use an anti-static pad: When configuring or working with an electrical component, place it on an anti-static pad. This reduces the possibility of ESD damage.

Appendix

B

Regulatory Compliance

DECLARATION OF CONFORMITY

This equipment has been tested and found to comply with specifications for CE marking. If the user modifies and/or installs other devices in the equipment, the CE conformity declaration may no longer apply.

FCC WARNING

This equipment complies with Part 15 of the FCC Rules. Operation is subject to the following two conditions:

- This device may not cause harmful interference, and
- This device must accept any interference received, including interference that may cause undesired operation.

This equipment has been tested and found to comply with the limits for a Class A digital device, pursuant to part 15 of the FCC Rules. These limits are designed to provide reasonable protection against harmful interference when the equipment is operated in a commercial environment. This equipment generates, uses, and can radiate radio frequency energy and, if not installed and used in accordance with the instruction manual, may cause harmful interference to radio communications. Operation of this equipment in a residential area is likely to cause harmful interference in which case the user will be required to correct the interference at his own expense.

Appendix

C

BIOS Menu Options

Below is a list of BIOS configuration options in the BIOS chapter.

- ➔ BIOS Information65
- ➔ Compute Die Information66
- ➔ PCH Information.....66
- ➔ System Date [xx:xx:xx].....67
- ➔ System Time [xx:xx:xx]67
- ➔ TPM Support [Enable]73
- ➔ TPM Device Selection [PTT].....73
- ➔ Pending operation [None]73
- ➔ Wake system with Fixed Time [Disabled].....75
- ➔ Serial Port [Enabled].....78
- ➔ Device Settings78
- ➔ Serial Port [Enabled].....79
- ➔ Device Settings79
- ➔ Serial Port [Enabled].....80
- ➔ Device Settings80
- ➔ Serial Port [Enabled].....81
- ➔ Device Settings81
- ➔ Serial Port [Enabled].....82
- ➔ Device Settings82
- ➔ Device Mode82
- ➔ Serial Port [Enabled].....83
- ➔ Device Settings83
- ➔ Device Mode84
- ➔ Serial Port [Enabled].....86
- ➔ Device Settings86
- ➔ Serial Port [Enabled].....86
- ➔ Device Settings87
- ➔ PC Health Status87
- ➔ Console Redirection [Disabled].....88
- ➔ Terminal Type [ANSI].....89
- ➔ Bits per second [115200].....89
- ➔ Data Bits [8]90
- ➔ Parity [None].....90

TANK-630-EHL

➔ Stop Bits [1]	90
➔ VT-d [Enabled].....	93
➔ Primary Display [Auto]	95
➔ Internal Graphics [Enabled].....	95
➔ Auto Power Button Function [Disabled (ATX)].....	96
➔ Restore AC Power Loss [Last State]	96
➔ Power Saving Function (EUP) [Disabled].....	97
➔ LAN1_USB1/LAN2_USB2 Power SW1 [+5V DUAL]	97
➔ LAN3_USB3/JUSB4 Power SW2 [+5V DUAL].....	97
➔ PCIe Speed [Auto].....	100
➔ Detect Non-Compliance Device [Disabled]	100
➔ SATA Mode Selection [AHCI].....	101
➔ Hot Plug [Disabled]	101
➔ HD Audio [Enabled]	102
➔ Administrator Password	103
➔ User Password	103
➔ Quiet Boot [Enabled]	104
➔ Launch PXE OpROM [Disabled]	104
➔ Boot Option #1	105
➔ Boot Option #2	105

Appendix

D

Hazardous Materials Disclosure

TANK-630-EHL

D.1 RoHS II Directive (2015/863/EU)

The details provided in this appendix are to ensure that the product is compliant with the RoHS II Directive (2015/863/EU). The table below acknowledges the presences of small quantities of certain substances in the product, and is applicable to RoHS II Directive (2015/863/EU).

Please refer to the following table.

Part Name	Toxic or Hazardous Substances and Elements									
	Lead (Pb)	Mercury (Hg)	Cadmium (Cd)	Hexavalent Chromium (CR(VI))	Polybrominated Biphenyls (PBBs)	Polybrominated Diphenyl Ethers (PBDEs)	Bis(2-ethylhexyl) phthalate (DEHP)	Butyl benzyl phthalate (BBP)	Dibutyl phthalate (DBP)	Diisobutyl phthalate (DIBP)
Housing	O	O	O	O	O	O	O	O	O	O
Printed Circuit Board	O	O	O	O	O	O	O	O	O	O
Metal Fasteners	O	O	O	O	O	O	O	O	O	O
Cable Assembly	O	O	O	O	O	O	O	O	O	O
Fan Assembly	O	O	O	O	O	O	O	O	O	O
Power Supply Assemblies	O	O	O	O	O	O	O	O	O	O
Battery	O	O	O	O	O	O	O	O	O	O
<p>O: This toxic or hazardous substance is contained in all of the homogeneous materials for the part is below the limit requirement in Directive (EU) 2015/863.</p> <p>X: This toxic or hazardous substance is contained in at least one of the homogeneous materials for this part is above the limit requirement in Directive (EU) 2015/863.</p>										

D.2 China RoHS

此附件旨在确保本产品符合中国 RoHS 标准。以下表格标示此产品中某有毒物质的含量符合中国 RoHS 标准规定的限量要求。

本产品上会附有“环境友好使用期限”的标签，此期限是估算这些物质“不会有泄漏或突变”的年限。本产品可能包含有较短的环境友好使用期限的可替换元件，像是电池或灯管，这些元件将会单独标示出来。

部件名称	有毒有害物质或元素					
	铅 (Pb)	汞 (Hg)	镉 (Cd)	六价铬 (CR(VI))	多溴联苯 (PBB)	多溴二苯醚 (PBDE)
壳体	○	○	○	○	○	○
印刷电路板	○	○	○	○	○	○
金属螺帽	○	○	○	○	○	○
电缆组装	○	○	○	○	○	○
风扇组装	○	○	○	○	○	○
电力供应组装	○	○	○	○	○	○
电池	○	○	○	○	○	○

○: 表示该有毒有害物质在该部件所有物质材料中的含量均在 SJ/T11364-2014 與 GB/T26572-2011 标准规定的限量要求以下。X: 表示该有毒有害物质至少在该部件的某一均质材料中的含量超出 SJ/T11364-2014 與 GB/T26572-2011 标准规定的限量要求。