



MODEL:
IASO-W07A-N6210

**7" Medical Panel PC with Intel® Celeron® Processor N6210,
P-CAP Touchscreen, 8 GB LPDDR4x, 32GB eMMC, HDMI Output,
Six USB 3.2, Wi-Fi 6, Dual GbE, Speaker and RoHS**

User Manual

Revision

Date	Version	Changes
June 7, 2023	1.00	Initial release

Copyright

COPYRIGHT NOTICE

The information in this document is subject to change without prior notice in order to improve reliability, design and function and does not represent a commitment on the part of the manufacturer.

In no event will the manufacturer be liable for direct, indirect, special, incidental, or consequential damages arising out of the use or inability to use the product or documentation, even if advised of the possibility of such damages.

This document contains proprietary information protected by copyright. All rights are reserved. No part of this manual may be reproduced by any mechanical, electronic, or other means in any form without prior written permission of the manufacturer.

TRADEMARKS

All registered trademarks and product names mentioned herein are used for identification purposes only and may be trademarks and/or registered trademarks of their respective owners.

CONTACT INFORMATION



Manufactured by:
IEI Integration Corp.

Address: No. 29, Zongxing Rd., Xizhi Dist.,
New Taipei City 221, Taiwan

Phone: +886-2-8691-6798

Fax: +886-2-6616-0028

Web Site: www.ieiworld.com

Sales Email: iei_medical@ieiworld.com

Manual Conventions



WARNING

Warnings appear where overlooked details may cause damage to the equipment or result in personal injury. Warnings should be taken seriously.



CAUTION

Cautionary messages should be heeded to help reduce the chance of losing data or damaging the product.



NOTE

These messages inform the reader of essential but non-critical information. These messages should be read carefully as any directions or instructions contained therein can help avoid making mistakes.

Table of Contents

1 INTRODUCTION.....	1
1.1 OVERVIEW.....	2
1.2 FEATURES.....	3
1.3 FRONT PANEL.....	3
1.4 BOTTOM PANEL	4
1.5 REAR PANEL	5
1.6 SYSTEM SPECIFICATIONS.....	6
1.7 DIMENSIONS.....	8
2 UNPACKING	9
2.1 UNPACKING.....	10
2.2 PACKING LIST	11
3 INSTALLATION	12
3.1 SAFETY PRECAUTIONS	13
3.2 ANTI-STATIC PRECAUTIONS.....	15
3.3 INSTALLATION PRECAUTIONS.....	16
3.4 GbE CONNECTION	17
3.5 AT/ATX MODE SELECTION.....	18
3.6 VESA MOUNTING.....	19
3.7 POWERING ON THE SYSTEM.....	20
3.8 CLEAR CMOS.....	22
3.9 RESET THE SYSTEM	22
3.10 SYSTEM MAINTENANCE	23
4 BIOS SETUP	24
4.1 INTRODUCTION.....	25
4.1.1 Starting Setup.....	25
4.1.2 Using Setup	26
4.1.2.1 Keyboard Navigation	26
4.1.2.2 Touch Navigation	27

4.1.3	<i>Getting Help</i>	27
4.1.4	<i>Unable to Reboot after Configuration Changes</i>	28
4.1.5	<i>BIOS Menu Bar</i>	28
4.2	MAIN	28
4.3	ADVANCED	29
4.3.1	<i>CPU Configuration</i>	30
4.3.2	<i>Trusted Computing</i>	32
4.3.3	<i>IT5571 H/W Monitor</i>	33
4.3.4	<i>RTC Wake Settings</i>	34
4.3.5	<i>Network Stack Configuration</i>	35
4.4	CHIPSET	36
4.4.1	<i>System Agent (SA) Configuration</i>	37
4.4.1.1	<i>Memory Configuration</i>	38
4.4.1.2	<i>Graphics Configuration</i>	39
4.4.2	<i>PCH-IO Configuration</i>	40
4.4.2.1	<i>PCI Express Configuration</i>	42
4.4.2.2	<i>SATA Configuration</i>	43
4.4.2.3	<i>HD Audio Configuration</i>	44
4.5	SECURITY	45
4.6	BOOT	46
4.7	SAVE & EXIT	46
5	DRIVER INSTALLATION	48
5.1	AVAILABLE DRIVERS	49
5.2	DRIVER DOWNLOAD	49
A	REGULATORY COMPLIANCE	51
B	PRODUCT DISPOSAL	56
C	MAINTENANCE AND CLEANING PRECAUTIONS	58
C.1.1	<i>Maintenance and Cleaning</i>	60
C.1.2	<i>Cleaning Tools</i>	60
D	SYMBOL DEFINITIONS	61
E	WATCHDOG TIMER	63
F	ERROR BEEP CODE	66

IASO-W07A-N6210 Medical Panel PC

F.1 PEI BEEP CODES	67
F.2 DXE BEEP CODES	67
G HAZARDOUS MATERIALS DISCLOSURE	68
G.1 RoHS II DIRECTIVE (2015/863/EU)	69
G.2 CHINA RoHS.....	70

List of Figures

Figure 1-1: IASO-W07A-N6210 Medical Panel PC	2
Figure 1-2: Front View	3
Figure 1-3: Bottom Panel	4
Figure 1-4: Rear View	5
Figure 1-5: Dimensions (mm)	8
Figure 3-1: Ethernet Connector	17
Figure 3-2: AT/ATX Switch Location	18
Figure 3-3: VESA Mounting Retention Screw Holes	19
Figure 3-4: Power Input Connector and Power Button	20
Figure 3-5: Power LED	21
Figure 3-6: Clear CMOS Button Location	22
Figure 3-7: Reset Button Location	22
Figure 5-1: IEI Resource Download Center	49

List of Tables

Table 1-1: System Specifications.....	7
Table 3-1: Ethernet Connector Pinouts	17
Table 3-2: Connector LEDs.....	17
Table 4-1: BIOS Navigation Keys	26
Table 4-2: BIOS On-screen Navigation Keys	27

Chapter

1

Introduction

1.1 Overview



Figure 1-1: IASO-W07A-N6210 Medical Panel PC

The IASO-W07A-N6210 is an Intel® Celeron® Processor N6210 powered medical-grade panel PC designed for easy and simplified integration into healthcare applications. The system has 8 GB of LPDDR4x memory on board, ensuring smooth data throughputs with reduced bottlenecks and fast system access.

The front panel is a P-CAP touchscreen, which allows multi-touch, multi-layer gloves and water-on-screen operation. A second display can be connected with the panel PC through the HDMI output connector for multi-screen applications.

Six USB 3.2 Gen 1 (5Gb/s) ports provide simplified connectivity to a variety of external peripheral devices. Wi-Fi 6 high efficiency wireless and two GbE RJ-45 connectors allow for smooth connection of the system to an external LAN.



NOTE:

The IASO-W07A-N6210 medical panel PC is intended to be used to display general purpose medical information. The device shall not be used for diagnosis purpose or life supporting system.

IASO-W07A-N6210 Medical Panel PC

1.2 Features

The IASO-W07A-N6210 features are listed below:

- Ultra-compact fanless medical-grade panel PC for easy installation
- P-CAP touchscreen supports multi-touch, gloved and wet hand operation
- Intel® Celeron® Processor N6210 platform
- Onboard 8 GB LPDDR4x memory
- One HDMI output port supports an additional display
- Two GbE RJ-45 ports
- Wi-Fi 6 high efficiency wireless
- Internal speaker
- Six USB 3.2 Gen 1 (5Gb/s) ports

1.3 Front Panel

The front side of the IASO-W07A-N6210 is a flat-bezel panel with a 7" LCD screen surrounded by an ABS/PC plastic frame. There is a power LED indicator located on the front panel. The status descriptions of the power LED indicator are listed below.

- **Off:** power cord not attached or power supply failure
- **Solid amber:** the system is connected to a power source and is ready to be turned on.
- **Solid green:** the system is turned on.

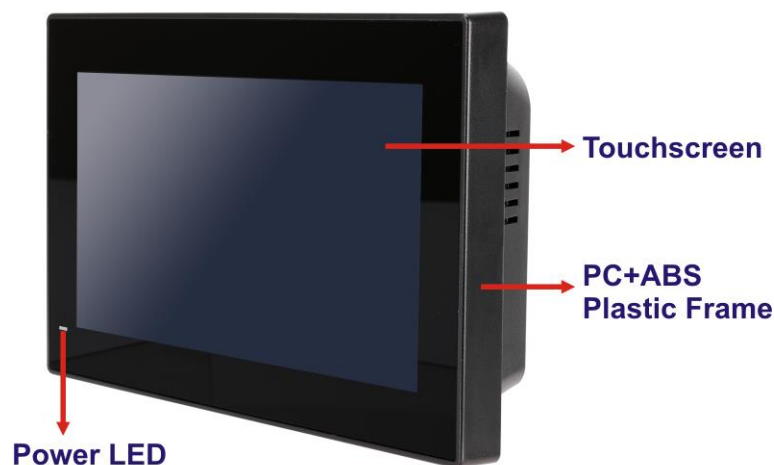

Figure 1-2: Front View

1.4 Bottom Panel

The bottom panel of the IASO-W07A-N6210 has the following connectors and components (**Figure 1-3**):

- 1 x 12 V DC input jack (standard)
- 1 x HDMI output connector
- 2 x 1GbE RJ-45
- 6 x USB 3.2 Gen 1 connector (5Gb/s)
- 1 x Power button
- 1 x Reset button
- 1 x Clear CMOS button
- 1 x AT/ATX power mode switch

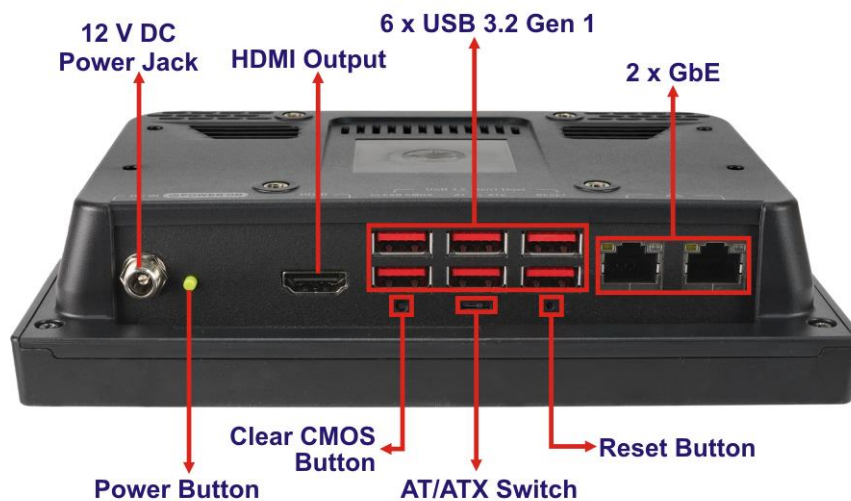

Figure 1-3: Bottom Panel

IASO-W07A-N6210 Medical Panel PC

1.5 Rear Panel

The rear panel contains four retention screw holes that support VESA 75 mount. A speaker is also pre-installed inside the rear panel. See **Figure 1-4**.

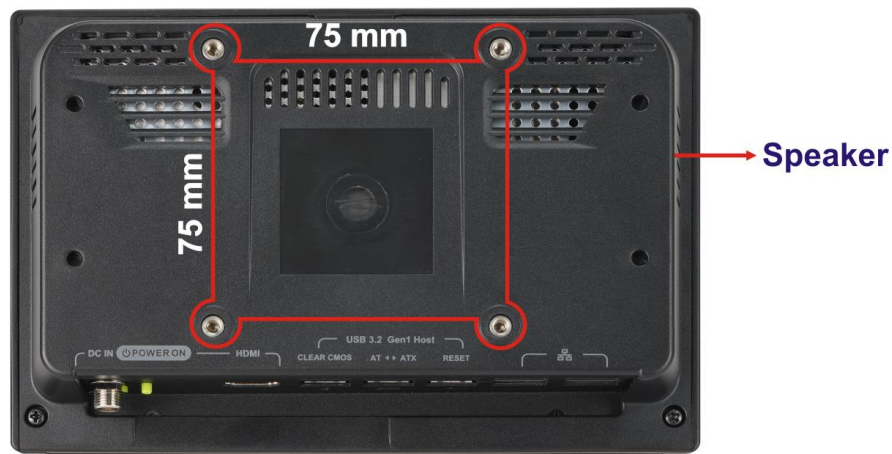

Figure 1-4: Rear View

1.6 System Specifications

The technical specifications for the IASO-W07A-N6210 systems are listed below.

LCD and Touchscreen	
LCD Size	7"
Max. Resolution	1024 (W) x 600 (H)
Brightness (cd/m²)	450
Contrast Ratio	800:1
Viewing Angle (H-V)	170°/170°
Backlight MTBF	20,000 hrs
Touchscreen	Projected capacitive type
Touch Controller	EETI
System	
CPU	Intel® Celeron® N6210 (code-named Elkhart Lake, 6.5W TDP)
Memory	Onboard 8GB LPDDR4x
Storage	32GB eMMC on board
GbE Controller	2 x Intel® I225-V Ethernet controllers
Expansion	1 x M.2 2230 A key slot (PCIe + USB, pre-installed with Wi-Fi module) 1 x M.2 2280 M key slot (SATA)
Audio	1 x AMP 1.5W (internal speaker)
Wi-Fi and Bluetooth	IEEE 802.11 a/b/g/n/ac/ax (Wi-Fi 6) via Intel® AX200 module Bluetooth v5.2
I/O Ports & Buttons	1 x 12V DC input jack 1 x HDMI output 2 x 1GbE LAN (RJ-45) 6 x USB 3.2 Gen 1 Type-A (5Gb/s) 1 x Power button 1 x Reset button 1 x Clear CMOS button 1 x AT/ATX power mode switch

IASO-W07A-N6210 Medical Panel PC

Physical		
Thermal	Fanless	
Mounting	VESA 75 mm x 75 mm	
Dimensions (W x H x D)	190.9 mm x 127.3 mm x 43.4 mm	
Weight (Net/Gross)	0.72 kg / 1.65 kg	
Environment		
Storage/Transportation	Temperature	-20°C - 60°C
	Humidity	10% - 95% (non-condensing)
	Pressure	700 hPa - 1060 hPa
Operating	Temperature	0°C - 40°C
	Humidity	20% - 80% (non-condensing)
	Pressure	700 hPa - 1060 hPa
Vibration	1G	
Shock	Operating Shock: 5G peak acceleration (11ms duration) Non-Operating Shock: 15G peak acceleration (11ms duration)	
EMC & Safety	CE, FCC Class B Part18 EN 60601-1:2005+AMD2:2021 (Edition 3.2) EN 60601-1-2: 2014 (Edition 4.0)	
Power		
Power Input	12 V DC	
Power Adapter	65 W FSP FSP065-DHBM1 medical-grade power adapter (P/N: 63040-010065-300-RS)	
	Input: 100 V AC - 240 V AC, 50 Hz - 60 Hz, 2.0 A – 1.0 A	
	Output: 12 V  5.42 A	

Table 1-1: System Specifications

1.7 Dimensions

The IASO-W07A-N6210 dimensions are shown below.

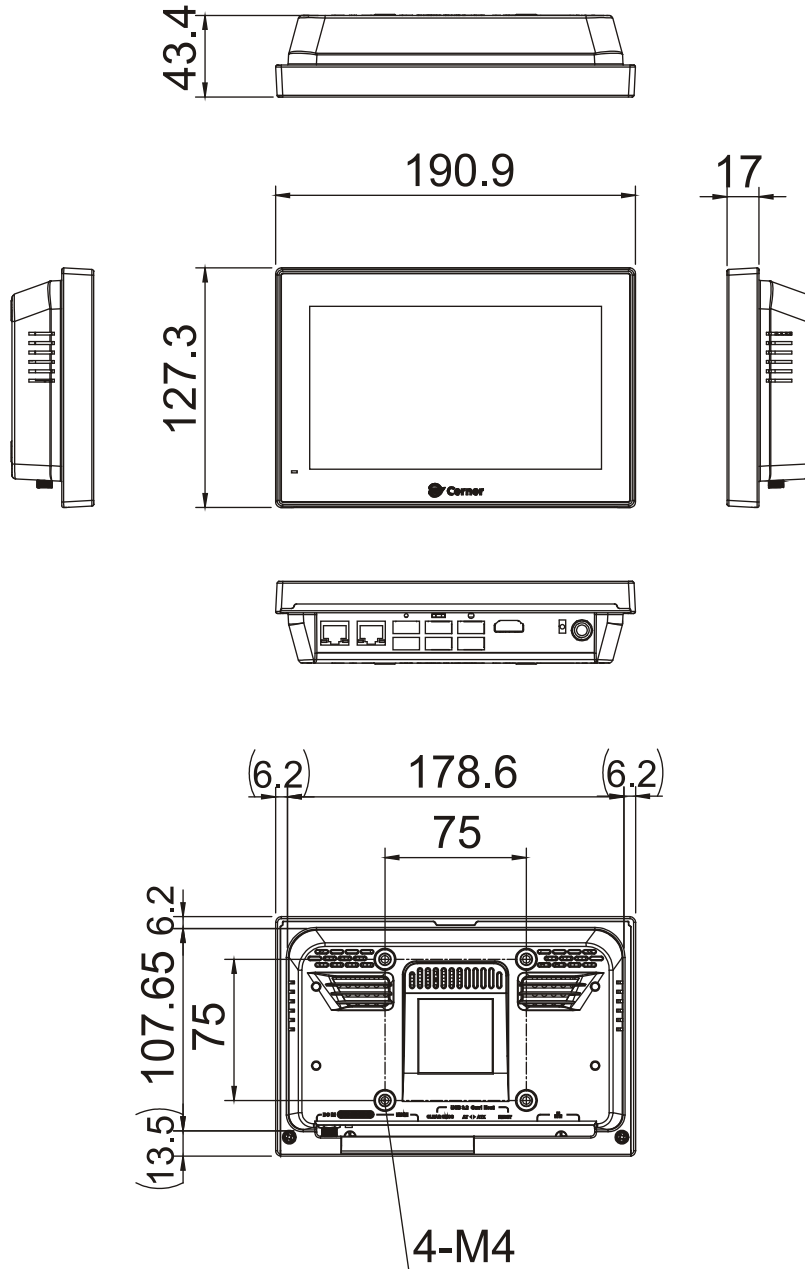

Figure 1-5: Dimensions (mm)

Chapter

2

Unpacking

2.1 Unpacking

To unpack the medical panel PC, follow the steps below:



WARNING / AVERTISSEMENT

The front side LCD screen has a protective plastic cover stuck to the screen. Only remove the plastic cover after the medical panel PC has been properly installed. This ensures the screen is protected during the installation process.

L'écran LCD avant a un couvercle en plastique de protection collé à l'écran. Retirez le couvercle en plastique uniquement une fois que le Panel PC médical a été correctement installé. Cela garantit que l'écran est protégé pendant le processus d'installation.

-
- Step 1:** Use box cutters, a knife or a sharp pair of scissors that seals the top side of the external (second) box.
 - Step 2:** Open the external (second) box.
 - Step 3:** Use box cutters, a knife or a sharp pair of scissors that seals the top side of the internal (first) box.
 - Step 4:** Lift the panel PC out of the boxes.
 - Step 5:** Remove both polystyrene ends, one from each side.
 - Step 6:** Pull the plastic cover off the medical panel PC.
 - Step 7:** Make sure all the components listed in the packing list are present.

IASO-W07A-N6210 Medical Panel PC





2.2 Packing List



NOTE:

If any of the components listed in the checklist below are missing, do not proceed with the installation. Contact the IEI reseller or vendor the IASO-W07A-N6210 was purchased from or contact an IEI sales representative directly by sending an email to iei_medical@ieiworld.com.

The IASO-W07A-N6210 medical panel PC is shipped with the following components:

Quantity	Item	Image
1	IASO-W07A-N6210 medical panel PC	
1	Medical-grade power adapter, 63040-010065-300-RS (FSP FSP065-DHBM1, 65W)	
1	Power cord (EU, 183cm)*	
	Power cord (US/Canada, 183cm)*	

*Either one; shipped according to the country code of the order.

Chapter

3

Installation

IASO-W07A-N6210 Medical Panel PC

3.1 Safety Precautions

Please ensure the following safety precautions are adhered to at all times.

- **External equipment intended for connection to signal input/output or other connectors, shall comply with relevant UL /IEC standard** (e.g. IEC60950 -1/IEC62368 -1 for IT equipment and ANSI/AAMI ES60601-1: 2012 AND CAN/CSA- C22.2 No. 60601-1:08/IEC 60601 series for systems—shall comply with the standard IEC 60601-1, Safety requirements for medical electrical systems. Equipment not complying with UL 60601-1 shall be kept outside the patient environment, as defined in the standard.
- **Remove the Power cord from A.C. MAINS if it will not to be used for a long time.**
- **To prevent the risk of electric shock, make sure power cord is unplugged from wall socket.** To fully disengage the power to the unit, please disconnect the power cord from the ac outlet. Refer servicing to qualified service personnel. The AC outlet shall be readily available and accessible.
- **Users must not allow SIP/SOPs and the patient to come into contact at the same time.**
- **Grounding reliability** can only be achieved when the equipment is connected to an equivalent receptacle marked “Hospital Only” or “Hospital Grade”.
- **Follow the electrostatic precautions** outlined below whenever the IASO-W07A-N6210 is opened.
- **Make sure the power is turned off and the power cord is disconnected** whenever the IASO-W07A-N6210 is being installed, moved or modified.
- **Do not apply voltage levels that exceed the specified voltage range.** Doing so may cause fire and/or an electrical shock. Use a power cord that matches the voltage of the power outlet, which has been approved and complies with the safety standard of your particular country.
- **Electric shocks can occur** if the IASO-W07A-N6210 chassis is opened when the IASO-W07A-N6210 is running. To avoid risk of electric shock, this equipment must only be connected to a supply mains with protective earth.

- **DO NOT LEAVE THIS EQUIPMENT IN AN UNCONTROLLED ENVIRONMENT WHERE THE STORAGE TEMPERATURE IS BELOW -20° C (-4°F) OR ABOVE 60° C (140° F). IT MAY DAMAGE THE EQUIPMENT.**
- ***If considerable amounts of dust, water, or fluids enter the IASO-W07A-N6210***, turn off the power supply immediately, unplug the power cord, and contact the IASO-W07A-N6210 vendor.
- ***Never replace or repair any components on your own.*** If the components of the IASO-W07A-N6210 fails or malfunctions it must be shipped back to IEI to be repaired. Please contact the system vendor, reseller or an IEI sales person directly.
- **DO NOT:**
 - Drop the IASO-W07A-N6210 against a hard surface.
 - Strike or exert excessive force onto the LCD panel.
 - Touch any of the LCD panels with a sharp object
 - In a site where the ambient temperature exceeds the rated temperature

IASO-W07A-N6210 Medical Panel PC

3.2 Anti-static Precautions



WARNING / AVERTISSEMENT

Failure to take ESD precautions during the maintenance of the IASO-W07A-N6210 may result in permanent damage to the IASO-W07A-N6210 and severe injury to the user.

Le fait de ne pas prendre des précautions contre les décharges électrostatiques pendant la maintenance du IASO-W07A-N6210 peut entraîner des dommages permanents au IASO-W07A-N6210 et des blessures graves pour l'utilisateur.

Electrostatic discharge (ESD) can cause serious damage to electronic components, including the IASO-W07A-N6210. Dry climates are especially susceptible to ESD. It is therefore critical that whenever the IASO-W07A-N6210 is accessed internally, or any other electrical component is handled, the following anti-static precautions are strictly adhered to.

- ***Wear an anti-static wristband:*** Wearing a simple anti-static wristband can help to prevent ESD from damaging the board.
- ***Use an anti-static pad:*** When configuring the IASO-W07A-N6210, place it on an anti-static pad. This reduces the possibility of ESD damaging the IASO-W07A-N6210.

3.3 Installation Precautions

When installing the medical panel PC, please follow the precautions listed below:

- **Certified Engineers:** Only certified engineers should install and modify the hardware settings.
- **Power turned off:** When installing the medical panel PC, make sure the power is off. Failing to turn off the power may cause severe injury to the body and/or damage to the system.
- **Anti-static Discharge:** If a user open the rear panel of the medical panel PC, to plug in added peripheral devices, ground themselves first and wear an anti-static wristband.
- **AC power plug:** AC plug is used as a means and device to be separated from the mains, and must be installed in a location where it can be easily unplugged



WARNING / AVERTISSEMENT

1. DO NOT modify this equipment without authorization of manufacturer.

Ne modifiez pas cet équipement sans l'autorisation du fabricant.

2. DO NOT power up the IASO-W07A-N6210 while the front panel is facing down on a sheet of conductive foam. Doing so may cause the touch panel to malfunction due to the large surface area of contact between the conductive form and the touch panel.

NE mettez PAS le IASO-W07A-N6210 sous tension lorsque le panneau avant est orienté vers le bas sur une feuille de mousse conductrice. Cela pourrait entraîner un dysfonctionnement de l'écran tactile en raison de la grande surface de contact entre la forme conductrice et l'écran tactile.

IASO-W07A-N6210 Medical Panel PC

3.4 GbE Connection

Each RJ-45 connector on the bottom panel allows 1GbE connection to be made to a Local Area Network.

Pin	Description	Pin	Description
1	MDIA3-	5	MDIA1+
2	MDIA3+	6	MDIA2+
3	MDIA2-	7	MDIA0-
4	MDIA1-	8	MDIA0+

Table 3-1: Ethernet Connector Pinouts

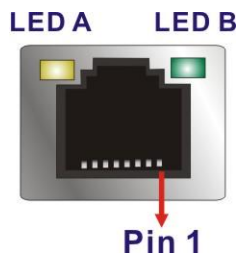

Figure 3-1: Ethernet Connector

LED	Description	LED	Description
A	on: linked blinking: data is being sent/received	B	off: 10 Mb/s green: 100 Mb/s orange: 1000 Mb/s

Table 3-2: Connector LEDs

3.5 AT/ATX Mode Selection

AT or ATX power mode can be used on the IASO-W07A-N6210. The selection is made through an AT/ATX switch located on the bottom panel (**Figure 3-2**).



Figure 3-2: AT/ATX Switch Location

IASO-W07A-N6210 Medical Panel PC

3.6 VESA Mounting

The IASO-W07A-N6210 is VESA (4 screws: M4 type, 6 mm length min.) compliant and can be mounted on a mounting device with a 75 mm interface pad. The IASO-W07A-N6210 VESA mount retention screw holes are shown below. Refer to the installation guide that came with the mounting device to mount the IASO-W07A-N6210.

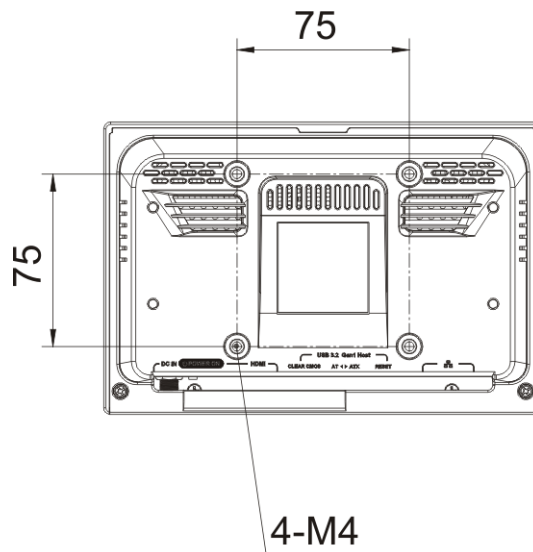

Figure 3-3: VESA Mounting Retention Screw Holes



WARNING / AVERTISSEMENT

Use suitable mounting apparatus and be sure to secure the screws of the mounting apparatus tightly to avoid risk of injury.

Utilisez un appareil de montage approprié et assurez-vous de bien fixer les vis de l'appareil de montage pour éviter tout risque de blessure.

3.7 Powering On the System



WARNING / AVERTISSEMENT

To avoid risk of electric shock, this equipment must only be connected to supply mains with protective earth.

Pour éviter tout risque d'électrocution, cet équipement ne doit être connecté qu'au secteur avec mise à la terre de protection.

To power on the system, follow the steps below:

Step 1: Connect the power cord to the power adapter. Connect the other end of the power cord to a power source. Connect the power adapter to the power connector of the IASO-W07A-N6210. **NOTE:** The FSP FSP065-DHBM1 power adapter came with the IASO-W07A-N6210 is a forming part of the medical device.

12 V DC Power Jack



Power Button

Figure 3-4: Power Input Connector and Power Button

Step 2: Locate the power button on the I/O panel.

Step 3: Hold down the power button until the power LED on the front panel turns on in green.

IASO-W07A-N6210 Medical Panel PC



Figure 3-5: Power LED

3.8 Clear CMOS

If the IASO-W07A-N6210 fails to boot due to improper BIOS settings, the clear CMOS jumper clears the CMOS data and resets the system BIOS information. To do this, push the clear CMOS button for three seconds, then restart the system. The clear CMOS button location is shown in **Figure 3-6**.



Figure 3-6: Clear CMOS Button Location

3.9 Reset the System

The reset button enables user to reboot the system when the system is on. The reset button location is shown in **Figure 3-7**. Press the reset button to reboot the system.



Figure 3-7: Reset Button Location

IASO-W07A-N6210 Medical Panel PC

3.10 System Maintenance

If the components of the IASO-W07A-N6210 fail, they must be replaced. Please contact the system reseller or vendor to purchase the replacement parts.



NOTE:

A user cannot replace a motherboard. If the motherboard fails it must be shipped back to IEI to be replaced. Please contact the system vendor, reseller or an IEI sales person directly.

Chapter

4

BIOS Setup

IASO-W07A-N6210 Medical Panel PC

4.1 Introduction

A licensed copy of the BIOS is preprogrammed into the ROM BIOS. The BIOS setup program allows users to modify the basic system configuration. This chapter describes how to access the BIOS setup program and the configuration options that may be changed.



NOTE:

Some of the BIOS options may vary throughout the life cycle of the product and are subject to change without prior notice.

4.1.1 Starting Setup

The UEFI BIOS is activated when the computer is turned on. The setup program can be activated in one of two ways.

1. **Using keyboard:** Press the **DEL** or **F2** as soon as the system is turned on.
2. **Using touchscreen:** Press the **Setup** button on the upper right corner of the BIOS Starting Menu.

If the message disappears before the **DEL** or **F2** key is pressed, restart the computer and try again, then the BIOS Starting Menu will appear. Select "Setup" and press Enter to get into the BIOS Setup.



4.1.2 Using Setup

The BIOS Setup menu can be navigated by using a keyboard or a touchscreen.

4.1.2.1 Keyboard Navigation

For keyboard navigation, use the navigation keys shown in **Table 4-1**.

Key	Function
Up arrow	Move to previous item
Down arrow	Move to next item
Left arrow	Move to the item on the left hand side
Right arrow	Move to the item on the right hand side
+	Increase the numeric value or make changes
-	Decrease the numeric value or make changes
Page Up	Move to the previous page
Page Dn	Move to the next page
Esc	Main Menu – Quit and not save changes into CMOS Status Page Setup Menu and Option Page Setup Menu -- Exit current page and return to Main Menu
F1	General help, only for Status Page Setup Menu and Option Page Setup Menu
F2	Load previous values
F3	Load optimized defaults
F4	Save changes and Exit BIOS
<K>	Scroll help area upwards
<M>	Scroll help area downwards

Table 4-1: BIOS Navigation Keys

IASO-W07A-N6210 Medical Panel PC

4.1.2.2 Touch Navigation

For touchscreen navigation, use the on-screen navigation keys shown below.

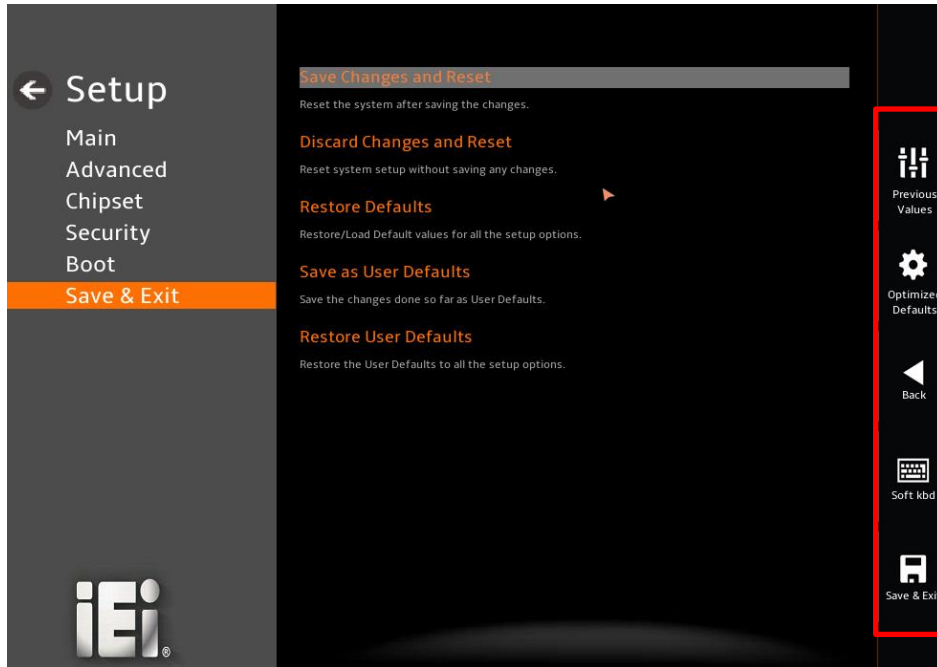

On-screen Button	Function
Previous Values	Load the last value you set.
Optimized Defaults	Load the factory default values in order to achieve the best performance.
Back	Return to the previous menu.
Soft kbd	Display the on-screen keyboard.
Save & Exit	Save the changes made to the BIOS options and reset the system.

Table 4-2: BIOS On-screen Navigation Keys

4.1.3 Getting Help

When **F1** is pressed a small help window describing the appropriate keys to use and the possible selections for the highlighted item appears. To exit the Help Window press **Esc** or the **F1** key again.

4.1.4 Unable to Reboot after Configuration Changes

If the computer cannot boot after changes to the system configuration are made, CMOS defaults.

4.1.5 BIOS Menu Bar

The **menu bar** on top of the BIOS screen has the following main items:

- Main – Changes the basic system configuration.
- Advanced – Changes the advanced system settings.
- Chipset – Changes the chipset settings.
- Boot – Changes the system boot configuration.
- Security – Sets User and Supervisor Passwords.
- Save & Exit – Selects exit options and loads default settings

The following sections completely describe the configuration options found in the menu items at the top of the BIOS screen and listed above.

4.2 Main

The **Main** BIOS menu (**BIOS Menu 1**) appears when the **BIOS Setup** program is entered. The **Main** menu gives an overview of the basic system information.

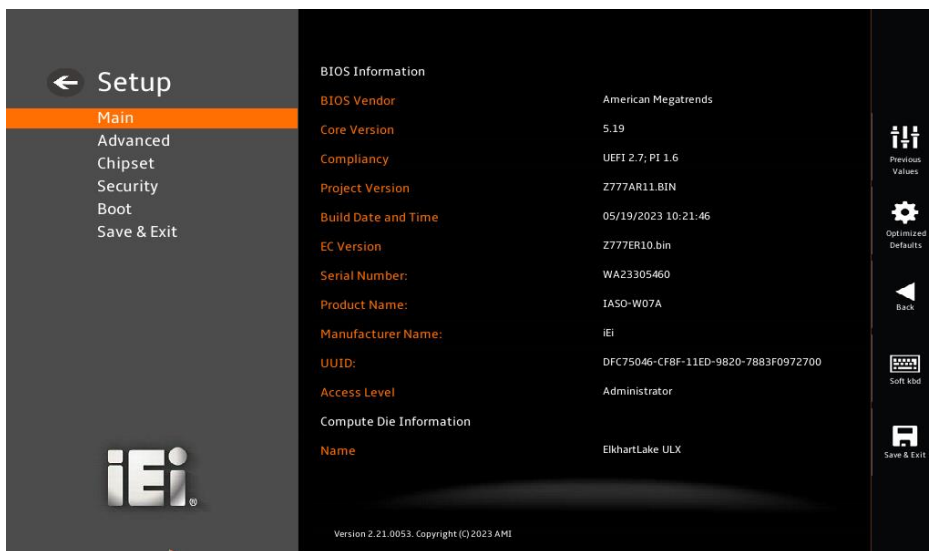

BIOS Menu 1: Main

IASO-W07A-N6210 Medical Panel PC

→ System Date [xx/xx/xx]

Use the **System Date** option to set the system date. Manually enter the day, month and year.

→ System Time [xx:xx:xx]

Use the **System Time** option to set the system time. Manually enter the hours, minutes and seconds.

4.3 Advanced

Use the **Advanced** menu (**BIOS Menu 2**) to configure the CPU and peripheral devices through the following sub-menus:

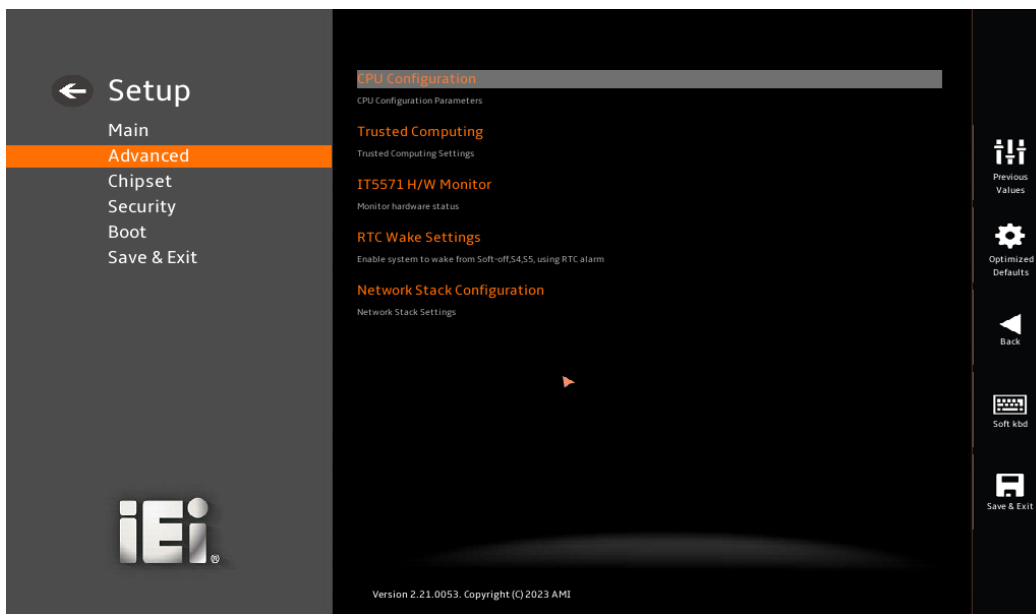

BIOS Menu 2: Advanced

4.3.1 CPU Configuration

Use the **CPU Configuration (BIOS Menu 3)** to view detailed CPU specifications and configure the CPU.



BIOS Menu 3: CPU Configuration

➔ Intel(R) SpeedStep(tm) [Enabled]

Use the **Intel(R) SpeedStep(tm)** option to enable or disable the Intel® SpeedStep™ technology.

- ➔ **Disabled** Disable Intel® SpeedStep™ technology
- ➔ **Enabled** **DEFAULT** Enable Intel® SpeedStep™ technology

➔ C states [Disabled]

Use the **C states** option to enable or disable CPU power management which allows CPU to go to C states when it is not 100% utilized.

- ➔ **Disabled** **DEFAULT** Disables CPU power management
- ➔ **Enabled** Enables CPU power management

IASO-W07A-N6210 Medical Panel PC

→ Intel Virtualization Technology [Enabled]

Use the **Intel Virtualization Technology** option to enable or disable virtualization on the system. When combined with third party software, Intel® Virtualization technology allows several OSs to run on the same system at the same time.

- **Disabled** Disables Intel Virtualization Technology.
- **Enabled** **DEFAULT** Enables Intel Virtualization Technology.

→ Active Processor Cores [All]

Use the **Active Processor Cores** BIOS option to enable numbers of cores in the processor package.

- **All** **DEFAULT** Enable all cores in the processor package.
- **1** Enable one core in the processor package.

→ Power Limit 1

Use the **Power Limit 1** to set Power Limit in Milli Watts. BIOS will round to the nearest 1/8W when programming. 0 = no custom override. For 12.50W, enter 12500. Overclocking SKU: Value must be between Max and Min Power Limits. Other SKUs: This value must be between Min Power limit and TDP Limit. If value is 0, BIOS will program TDP value.

→ Power Limit 1 Time Window

Power Limit 1 Time Window value in second. The value may vary from 0 to 128.0, 0 = default value (28 sec for mobile and 8 sec for desktop). Defines time window which TDP value should be maintained.

→ Power Limit 2

Use the Power Limit 2 to set Power Limit in Milli Watts. BIOS will round to the nearest 1/8W when programming. If the value is 0, BIOS will program this value as 1.25*TDP. For 12.50W, enter 12500. Processor applies control policies such that the package power does not exceed this limit.

4.3.2 Trusted Computing

Use the **Trusted Computing** menu (**BIOS Menu 4**) to configure settings related to the Trusted Computing Group (TCG) Trusted Platform Module (TPM).

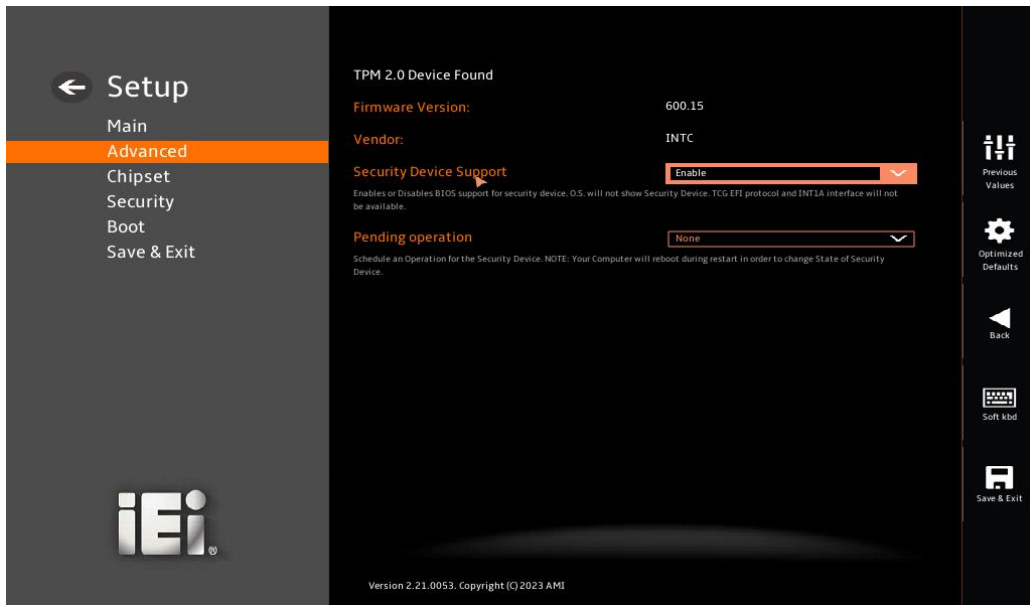

BIOS Menu 4: Trusted Computing

➔ Security Device Support [Enable]

Use the **Security Device Support** option to configure support for the security device.

- ➔ **Disable** Security device support is disabled.
- ➔ **Enable** **DEFAULT** Security device support is enabled.

➔ Pending Operation [None]

Use the **Pending Operation** option to schedule an operation for the security device.

- ➔ **None** **DEFAULT** TPM information is previous
- ➔ **TPM Clear** TPM information is cleared

IASO-W07A-N6210 Medical Panel PC

4.3.3 IT5571 H/W Monitor

The IT5571 H/W Monitor menu (**BIOS Menu 5**) shows the state of H/W real-time operating temperature, fan speeds and system voltages.



BIOS Menu 5: IT5571 H/W Monitor

→ Hardware Health Status

The following system parameters and values are shown. The system parameters that are monitored are:

- CPU Temperature
- System Temperature
- Voltages:
 - CPU_CORE
 - +5V
 - +12V
 - +DDR
 - +3.3V
 - +3.3VSB

4.3.4 RTC Wake Settings

The **RTC Wake Settings** menu (**BIOS Menu 6**) configures RTC wake event.

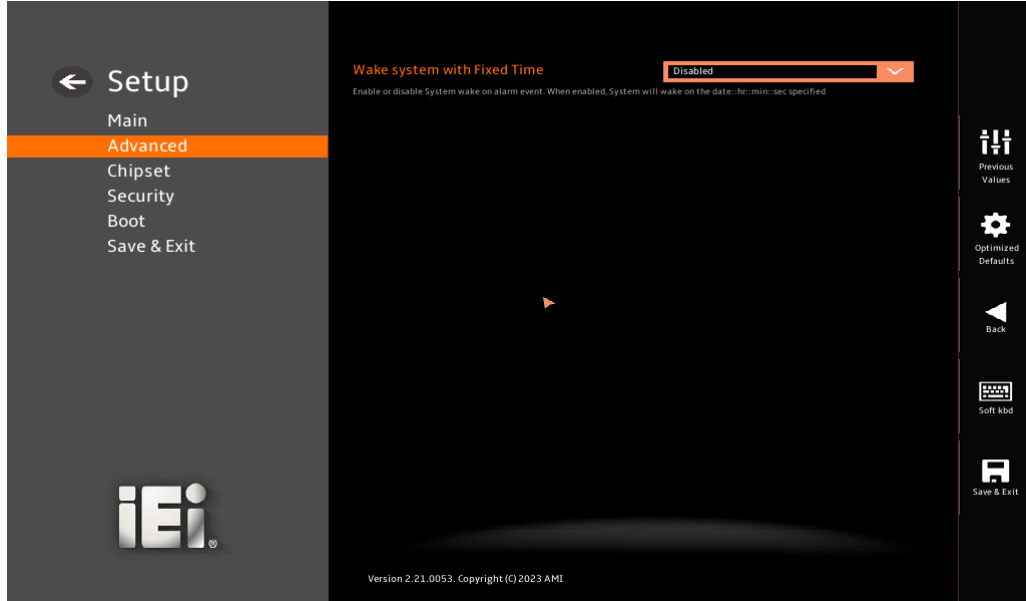

BIOS Menu 6: RTC Wake Settings

➔ **Wake System with Fixed Time [Disabled]**

Use the **Wake System with Fixed Time** option to specify the time the system should be roused from a suspended state.

- ➔ **Disabled** **DEFAULT** The real time clock (RTC) cannot generate a wake event
- ➔ **Enabled** If selected, the following appears with values that can be selected:
 - *Wake up every day
 - *Wake up date
 - *Wake up hour
 - *Wake up minute
 - *Wake up second
 After setting the alarm, the computer turns itself on from a suspend state when the alarm goes off.

IASO-W07A-N6210 Medical Panel PC

4.3.5 Network Stack Configuration

The **Network Stack Configuration** menu (**BIOS Menu 7**) configures network stack settings.

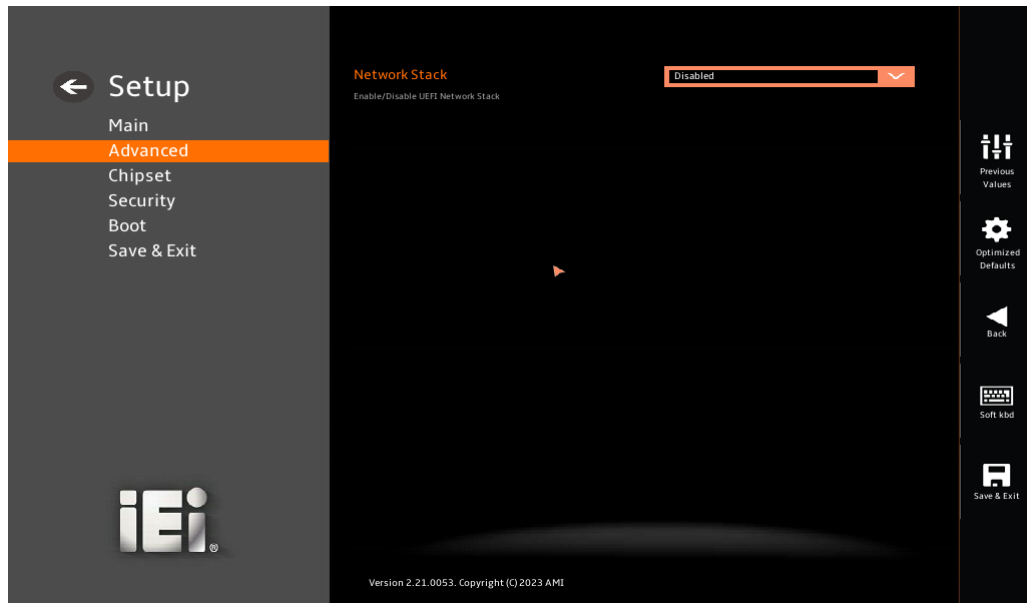

BIOS Menu 7: Network Stack Configuration

→ Network Stack [Disabled]

Use the **Network Stack** option to enable or disable UEFI network stack.

- **Disabled** **DEFAULT** Disable UEFI network stack
- **Enabled** Enable UEFI network stack

4.4 Chipset

Use the **Chipset** menu (**BIOS Menu 8**) to configure the system chipset.

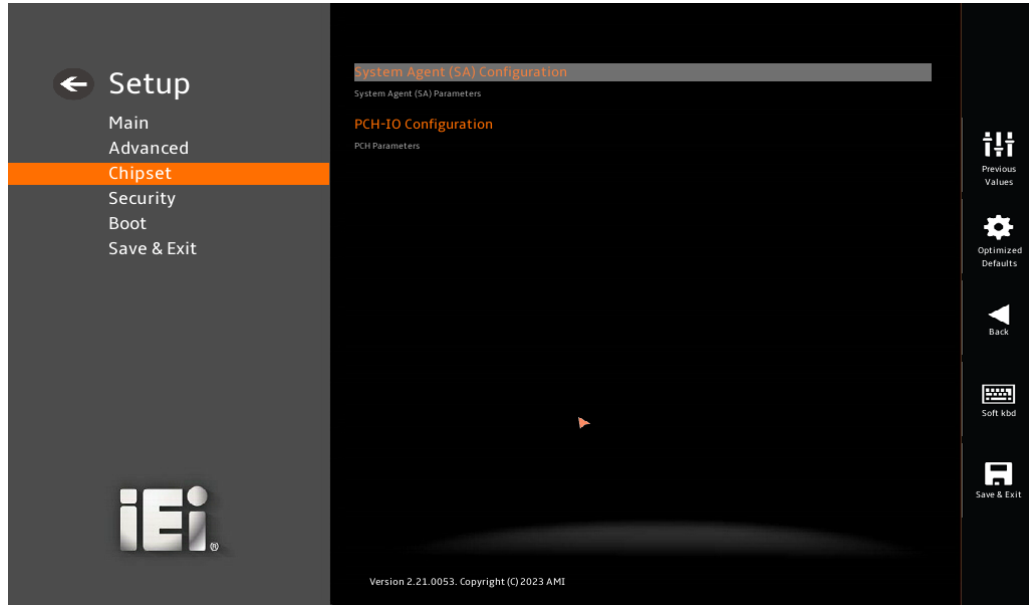

BIOS Menu 8: Chipset

IASO-W07A-N6210 Medical Panel PC

4.4.1 System Agent (SA) Configuration

Use the **System Agent (SA) Configuration** menu (**BIOS Menu 9**) to configure the System Agent (SA) parameters.

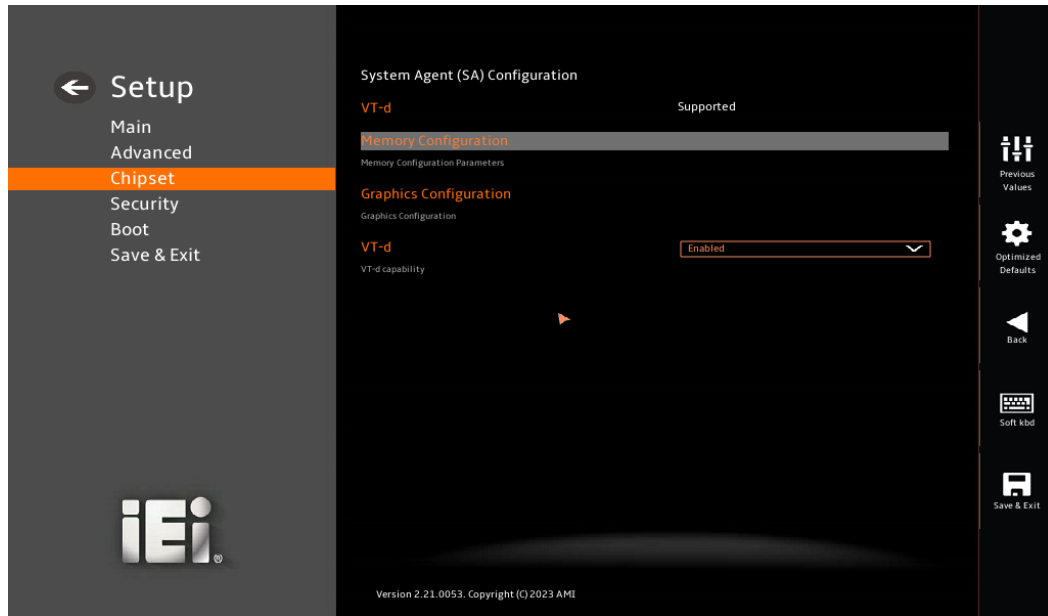

BIOS Menu 9: System Agent (SA) Configuration

➔ **VT-d [Enabled]**

Use the **VT-d** option to enable or disable VT-d support.

- ➔ **Disabled** Disable VT-d support.
- ➔ **Enabled** **DEFAULT** Enable VT-d support.

4.4.1.1 Memory Configuration

Use the **Memory Configuration** submenu (**BIOS Menu 10**) to display the memory information.

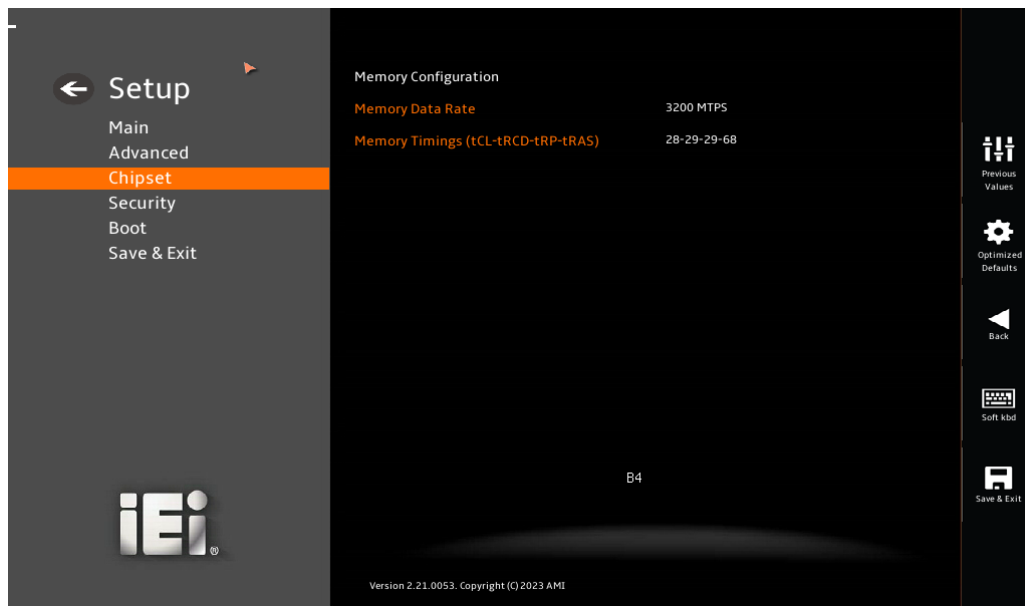

BIOS Menu 10: Memory Configuration

IASO-W07A-N6210 Medical Panel PC

4.4.1.2 Graphics Configuration

Use the **Graphics Configuration** menu (**BIOS Menu 11**) to view the graphics settings.

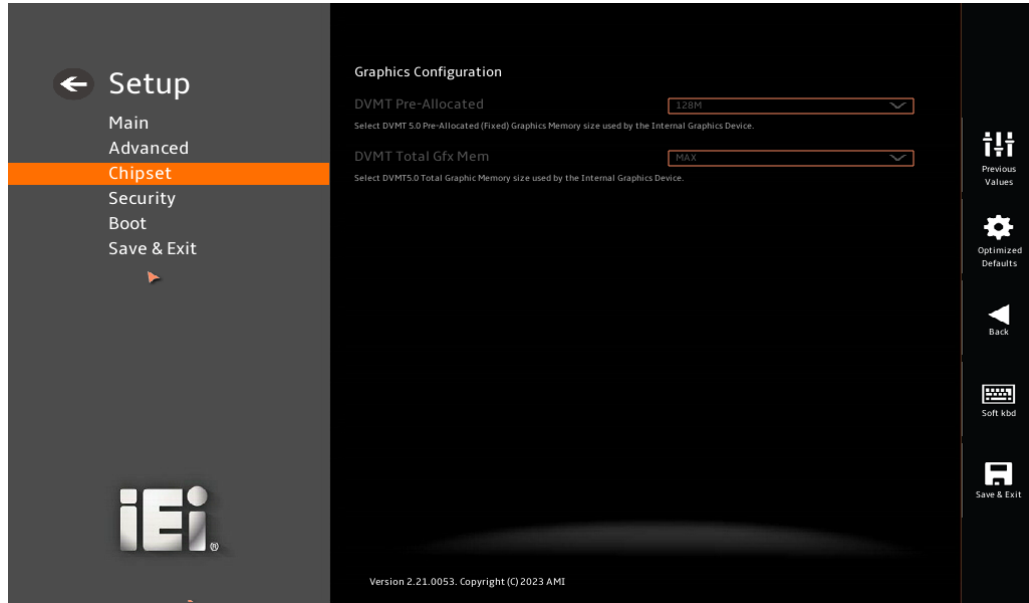

BIOS Menu 11: Graphics Configuration

4.4.2 PCH-IO Configuration

Use the **PCH-IO Configuration** menu (**BIOS Menu 12**) to configure the PCH-IO chipset.

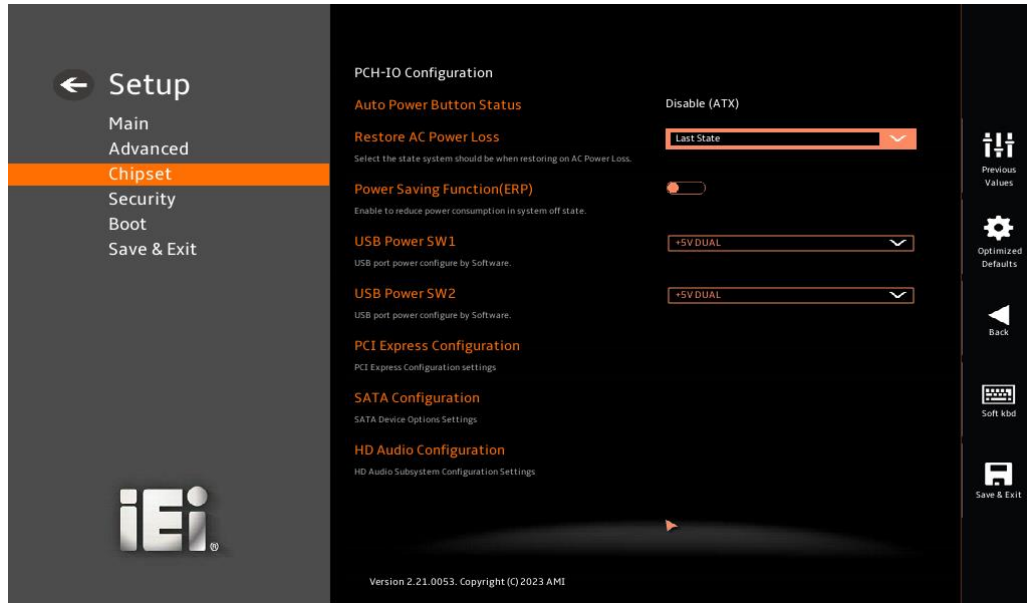

BIOS Menu 12: PCH-IO Configuration

→ Restore AC Power Loss [Last State]

Use the **Restore AC Power** BIOS option to specify what state the system returns to if there is a sudden loss of power to the system.

- **Power Off** The system remains turned off
- **Power On** The system turns on
- **Last State** **DEFAULT** The system returns to its previous state. If it was on, it turns itself on. If it was off, it remains off.

IASO-W07A-N6210 Medical Panel PC

→ Power Saving Function(ERP) [Disabled]

Use the **Power Saving Function(ERP)** BIOS option to enable or disable the power saving function.

- **Disabled** **DEFAULT** Power saving function is disabled.
- **Enabled** Power saving function is enabled. It will reduce power consumption when the system is off.

→ USB Power SW [+5V DUAL]

Use the **USB Power SW** BIOS option to configure whether to provide power to the USB connectors when the system is in S3/S4 sleep state. This option is valid only when the above **Power Saving Function (ERP)** BIOS option is disabled.

- **+5V** **DEFAULT** Power is provided to the USB connectors when the system is in S3/S4 sleep state
- **DUAL**
- **+5V** Power is not provided to the USB connectors when the system is in S3/S4 sleep state

4.4.2.1 PCI Express Configuration

Use the **PCI Express Configuration** submenu (**BIOS Menu 13**) to configure the PCI Express slots.

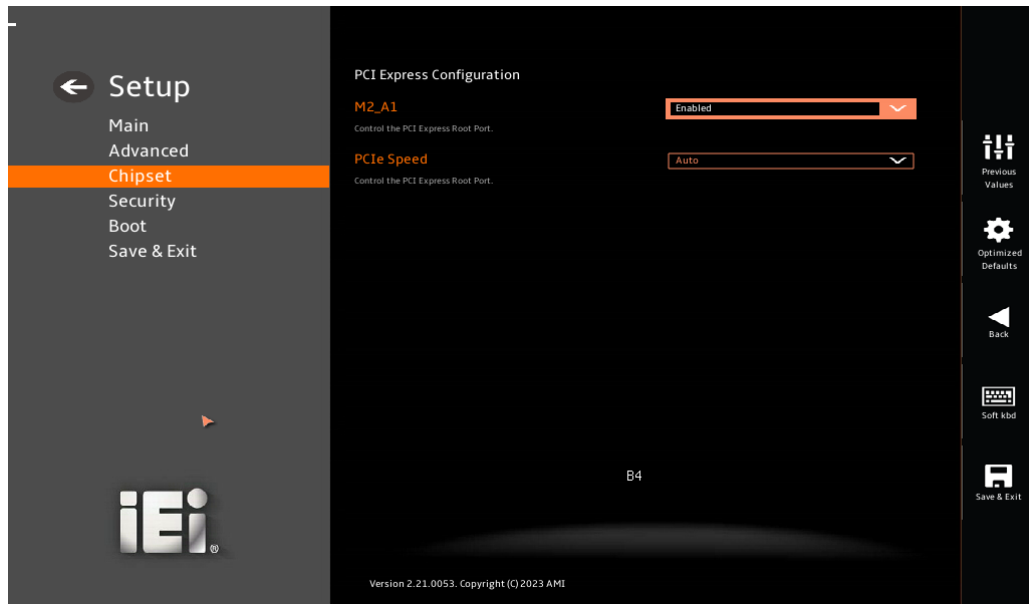

BIOS Menu 13: PCI Express Configuration

→ M2_A1 [Enabled]

Use the **M2_A1** option to enable or disable the M.2 expansion slot.

- | | | |
|------------|----------------|------------------------------|
| → Disabled | | Disables the expansion slot. |
| → Enabled | DEFAULT | Enables the expansion slot. |

→ PCIe Speed [Auto]

Use the **PCIe Speed** option to configure the PCIe interface speed.

- | | |
|---------|----------------|
| ▪ Auto | DEFAULT |
| ▪ Gen 1 | |
| ▪ Gen 2 | |
| ▪ Gen 3 | |

IASO-W07A-N6210 Medical Panel PC

4.4.2.2 SATA Configuration

Use the **SATA Configuration** menu (**BIOS Menu 14**) to change and/or set the configuration of the SATA devices installed in the system.

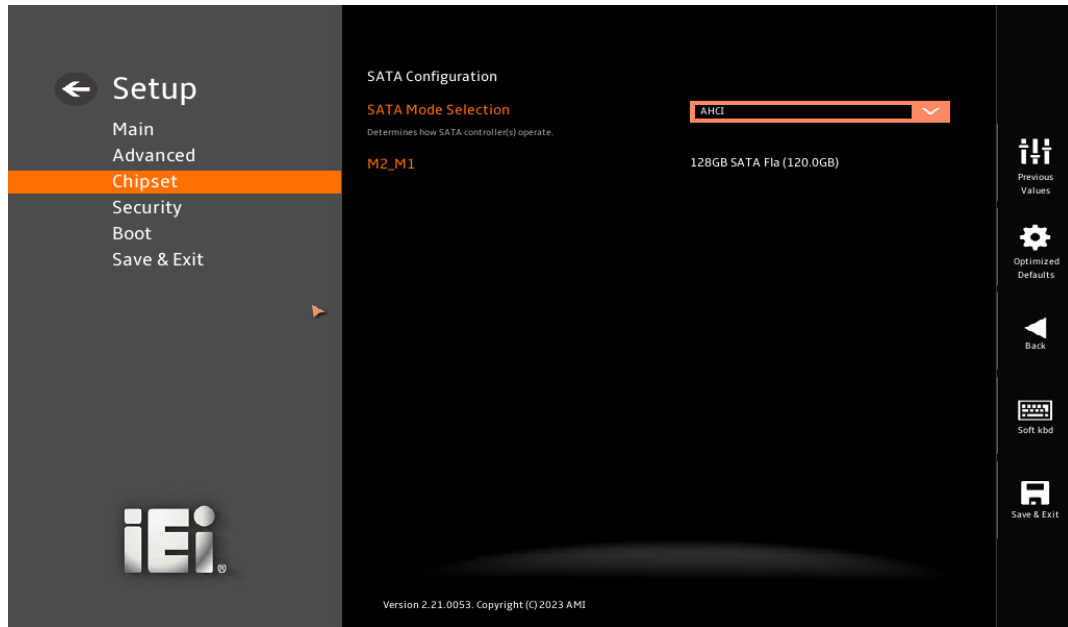

BIOS Menu 14: SATA Configuration

→ **SATA Mode Selection [AHCI]**

Use the **SATA Mode Selection** option to configure how the SATA controller(s) operate.

→ **AHCI** **DEFAULT** Configures SATA devices as AHCI device.

4.4.2.3 HD Audio Configuration

Use the **HD Audio Configuration** menu (**BIOS Menu 15**) to configure the PCH Azalia settings.

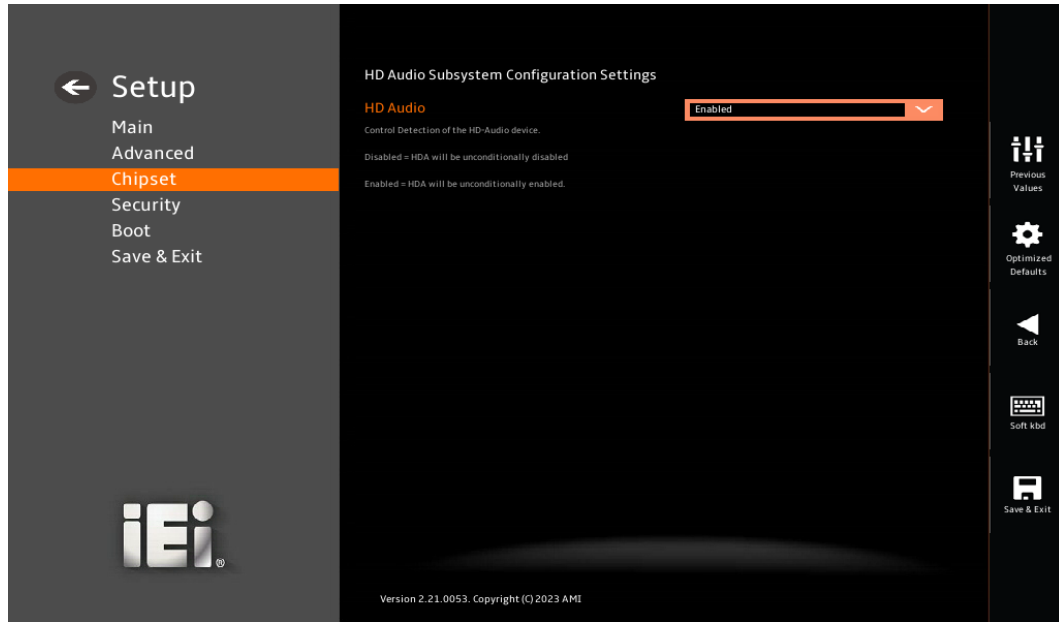

BIOS Menu 15: HD Audio Configuration

➔ **HD Audio [Enabled]**

Use the **HD Audio** option to enable or disable the High Definition Audio controller.

- ➔ **Disabled** The onboard High Definition Audio controller is disabled.
- ➔ **Enabled** **DEFAULT** The onboard High Definition Audio controller is enabled.

IASO-W07A-N6210 Medical Panel PC

4.5 Security

Use the **Security** menu (**BIOS Menu 16**) to set system and user passwords.

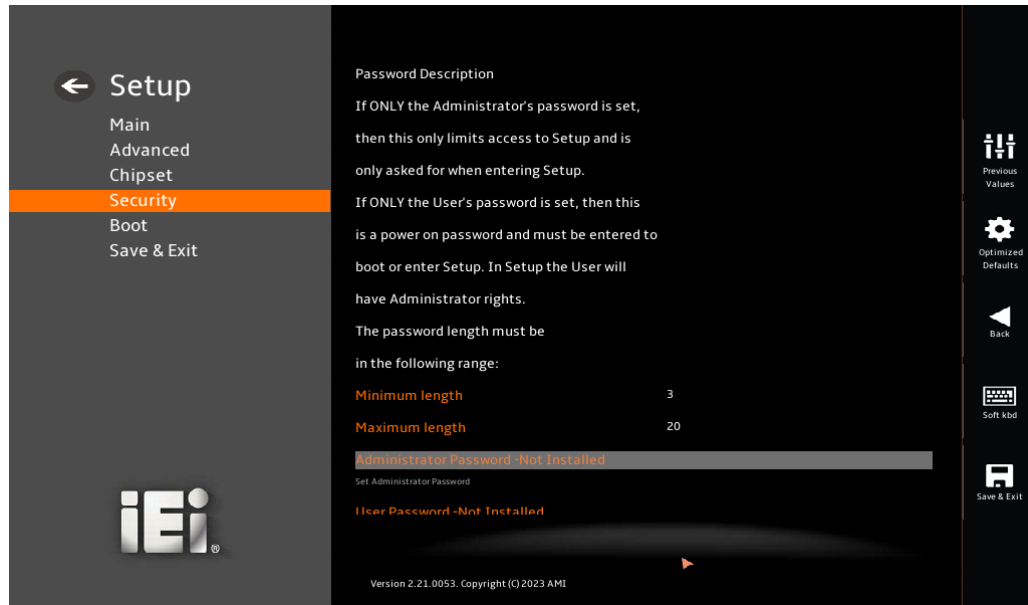

BIOS Menu 16: Security

→ Administrator Password

Use the **Administrator Password** field to set or change an administrator password.

→ User Password

Use the **User Password** field to set or change a user password.

4.6 Boot

Use the **Boot** menu (**BIOS Menu 17**) to configure system boot options.

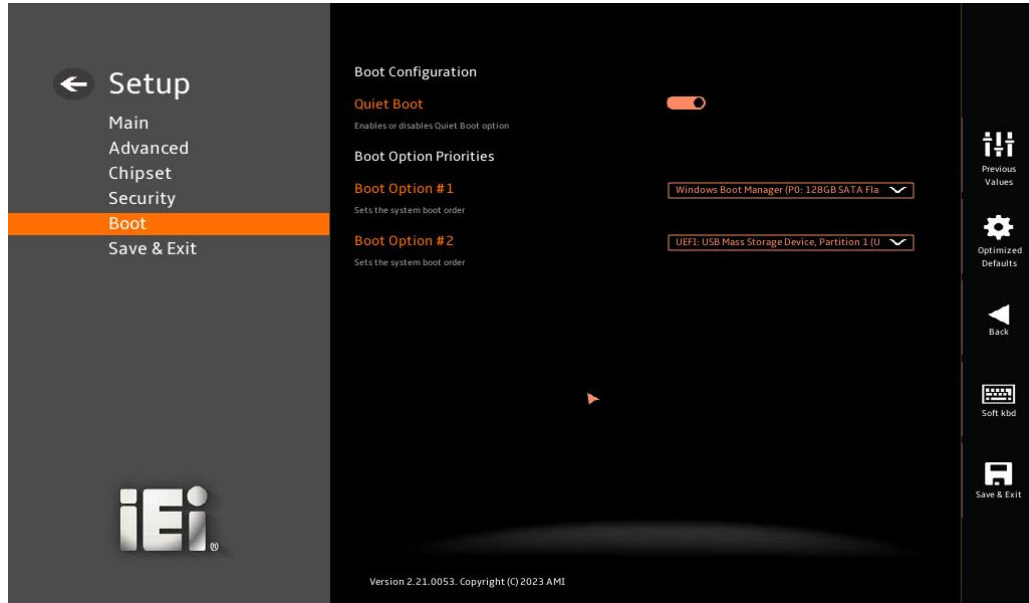

BIOS Menu 17: Boot

➔ Quiet Boot [Enabled]

Use the **Quiet Boot** BIOS option to select the screen display when the system boots.

- ➔ **Disabled** Normal POST messages displayed
- ➔ **Enabled** **DEFAULT** OEM Logo displayed instead of POST messages

4.7 Save & Exit

Use the **Save & Exit** menu (**BIOS Menu 18**) to load default BIOS values, optimal failsafe values and to save configuration changes.

IASO-W07A-N6210 Medical Panel PC

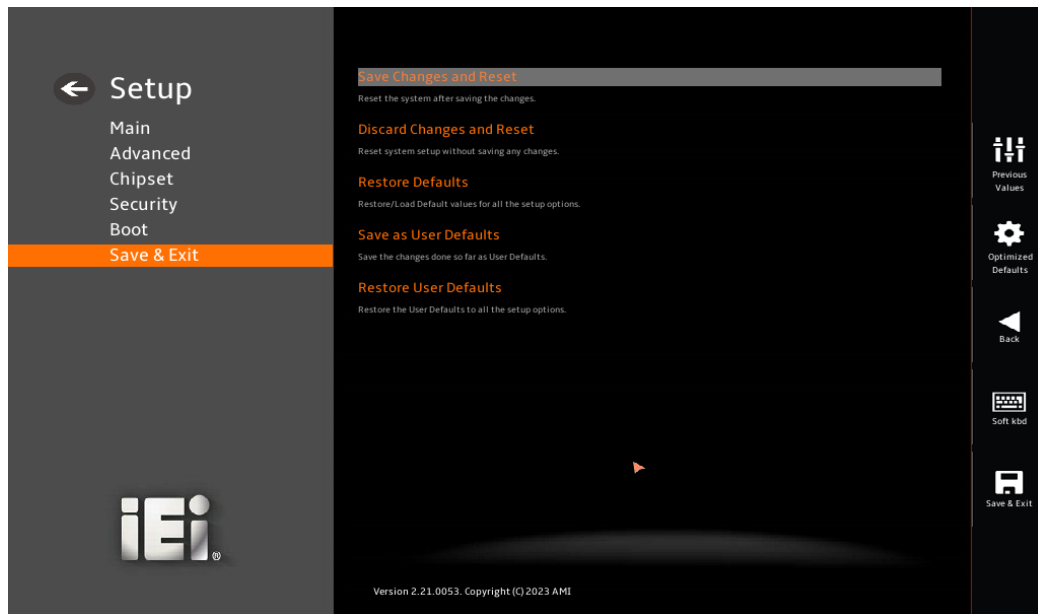
**BIOS Menu 18: Save & Exit****→ Save Changes and Reset**

Use the **Save Changes and Reset** option to save the changes made to the BIOS options and reset the system.

→ Discard Changes and Reset

Use the **Discard Changes and Reset** option to exit the system without saving the changes made to the BIOS configuration setup program.

→ Restore Defaults

Use the **Restore Defaults** option to load the optimal default values for each of the parameters on the Setup menus. **F3 key can be used for this operation.**

→ Save as User Defaults

Use the **Save as User Defaults** option to save the changes done so far as user defaults.

→ Restore User Defaults

Use the **Restore User Defaults** option to restore the user defaults to all the setup options.

Chapter

5

Driver Installation

IASO-W07A-N6210 Medical Panel PC

5.1 Available Drivers

All the drivers for the IASO-W07A-N6210 are available on IEI Resource Download Center (<https://download.ieiworld.com>). Type IASO-W07A-N6210, and press Enter to find all the relevant software, utilities, and documentation.

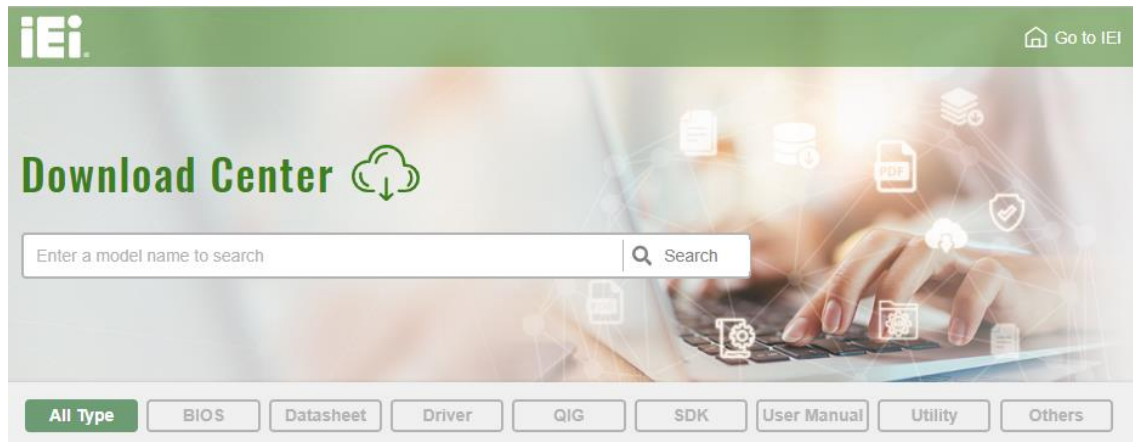
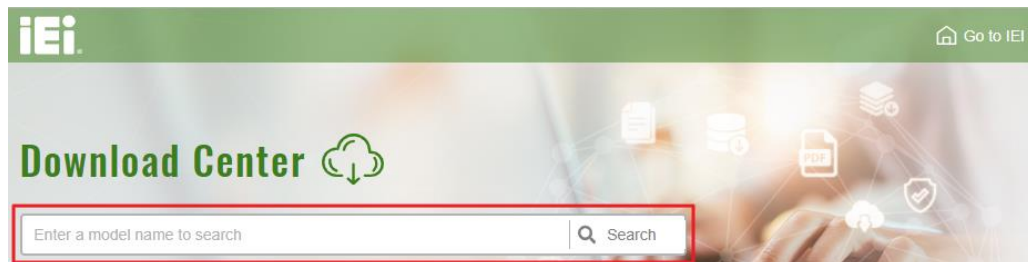

Figure 5-1: IEI Resource Download Center

5.2 Driver Download

To download drivers from IEI Resource Download Center, follow the steps below.

Step 1: Go to <https://download.ieiworld.com>. Type IASO-W07A-N6210, and press Enter.



Step 2: All product-related software, utilities, and documentation will be listed. You can choose **Driver** to filter the result.

All Type | BIOS | Datasheet | **Driver** | QIG | SDK | User Manual | Utility | Others

WAFER-BT-i1 Product Info ▶

Embedded Computer ▶ Single Board Computer ▶ Embedded Board
3.5" SBC with Intel® 22nm Atom™/Celeron® on-board SoC

Driver

File Name	Published	Version	File Checksum
7B000-001033-RS V2.3.iso (2.23 GB)	2017/10/03	2.30	3B2DB1F792779A93A8F50DDBC3943E30

Step 3: Click the driver file name on the page and you will be prompted with the following window. You can download the entire ISO file (❶), or click the small arrow to find an individual driver and click the file name to download (❷).

7B000-001168-RS_V1.4.iso [X]

❶ [Click here to download entire ISO file. \(2.99 GB\)](#)

* Download individual file *

- Docs
 - 1.Chipset
 - ❷ 10.1.1.12.zip (2.7 MB)
 - 2.VGA
 - 3.Audio
 - 4.Lan
 - 5.USB 3.0
 - 6.Serial IO
 - 7.TXE
 - 8.Manual



NOTE:

To install software from the downloaded ISO image file in Windows 8, 8.1 or 10, double-click the ISO file to mount it as a virtual drive to view its content.

Appendix

A

Regulatory Compliance

DECLARATION OF CONFORMITY



This equipment is in conformity with the following EU directives:

- EMC Directive (2004/108/EC, 2014/30/EU)
- Low-Voltage Directive (2006/95/EC, 2014/35/EU)
- RoHS II Directive (2011/65/EU, 2015/863/EU)
- Medical Device Directive 93/42/EEC: EN 60601-1

If the user modifies and/or install other devices in the equipment, the CE conformity declaration may no longer apply.

If this equipment has telecommunications functionality, it also complies with the requirements of the Radio Equipment Directive 2014/53/EU.

English

IEI Integration Corp. declares that this equipment is in compliance with the essential requirements and other relevant provisions of Directive 2014/53/EU.

Български [Bulgarian]

IEI Integration Corp. декларира, че този оборудване е в съответствие със съществените изисквания и другите приложими правила на Директива 2014/53/EU.

Česky [Czech]

IEI Integration Corp. tímto prohlašuje, že tento zařizení je ve shodě se základními požadavky a dalšími příslušnými ustanoveními směrnice 2014/53/EU.

Dansk [Danish]

IEI Integration Corp. erklærer herved, at følgende udstyr overholder de væsentlige krav og øvrige relevante krav i direktiv 2014/53/EU.

Deutsch [German]

IEI Integration Corp. erklärt dieses Gerät entspricht den grundlegenden Anforderungen und den weiteren entsprechenden Vorgaben der Richtlinie 2014/53/EU.

Eesti [Estonian]

IEI Integration Corp. deklareerib seadme seadme vastavust direktiivi 2014/53/EÜ põhinõuetele ja nimetatud direktiivist tulenevatele teistele asjakohastele sätetele.

IASO-W07A-N6210 Medical Panel PC

Español [Spanish]

IEI Integration Corp. declara que el equipo cumple con los requisitos esenciales y cualesquiera otras disposiciones aplicables o exigibles de la Directiva 2014/53/EU.

Ελληνική [Greek]

IEI Integration Corp. ΔΗΛΩΝΕΙ ΟΤΙ ΕΞΟΠΛΙΣΜΟΣ ΣΥΜΜΟΡΦΩΝΕΤΑΙ ΠΡΟΣ ΤΙΣ ΟΥΣΙΩΔΕΙΣ ΑΠΑΙΤΗΣΕΙΣ ΚΑΙ ΤΙΣ ΛΟΙΠΕΣ ΣΧΕΤΙΚΕΣ ΔΙΑΤΑΞΕΙΣ ΤΗΣ ΟΔΗΓΙΑΣ 2014/53/EU.

Français [French]

IEI Integration Corp. déclare que l'appareil est conforme aux exigences essentielles et aux autres dispositions pertinentes de la directive 2014/53/EU.

Italiano [Italian]

IEI Integration Corp. dichiara che questo apparecchio è conforme ai requisiti essenziali ed alle altre disposizioni pertinenti stabilite dalla direttiva 2014/53/EU.

Latviski [Latvian]

IEI Integration Corp. deklarē, ka iekārta atbilst būtiskajām prasībām un citiem ar to saistītajiem noteikumiem Direktīvas 2014/53/EU.

Lietuvių [Lithuanian]

IEI Integration Corp. deklaruoja, kad šis įranga atitinka esminius reikalavimus ir kitas 2014/53/EU Direktyvos nuostatas.

Nederlands [Dutch]

IEI Integration Corp. dat het toestel toestel in overeenstemming is met de essentiële eisen en de andere relevante bepalingen van richtlijn 2014/53/EU.

Malti [Maltese]

IEI Integration Corp. jiddikjara li dan prodott jikkonforma mal-ftigijiet essenzjali u ma provvedimenti oħrajn relevanti li hemm fid-Direttiva 2014/53/EU.

Magyar [Hungarian]

IEI Integration Corp. nyilatkozom, hogy a berendezés megfelel a vonatkozó alapvető követelményeknek és az 2014/53/EU irányelv egyéb előírásainak.

Polski [Polish]

IEI Integration Corp. oświadcza, że wyrobu jest zgodny z zasadniczymi wymogami oraz pozostałymi stosownymi postanowieniami Dyrektywy 2014/53/EU.

Português [Portuguese]

IEI Integration Corp. declara que este equipamento está conforme com os requisitos essenciais e outras disposições da Directiva 2014/53/EU.

Româna [Romanian]

IEI Integration Corp. declară că acest echipament este în conformitate cu cerințele esențiale și cu celelalte prevederi relevante ale Directivei 2014/53/EU.

Slovensko [Slovenian]

IEI Integration Corp. izjavlja, da je ta opreme v skladu z bistvenimi zahtevami in ostalimi relevantnimi določili direktive 2014/53/EU.

Slovensky [Slovak]

IEI Integration Corp. týmto vyhlasuje, že zariadenia spĺňa základné požiadavky a všetky príslušné ustanovenia Smernice 2014/53/EU.

Suomi [Finnish]

IEI Integration Corp. vakuuttaa täten että laitteet on direktiivin 2014/53/EU oleellisten vaatimusten ja sitä koskevien direktiivin muiden ehtojen mukainen.

Svenska [Swedish]

IEI Integration Corp. förklarar att denna utrustningstyp står i överensstämmelse med de väsentliga egenskapskrav och övriga relevanta bestämmelser som framgår av direktiv 2014/53/EU.

FCC WARNING

This equipment complies with part 18 of the FCC Rules.

This equipment generates, uses and can radiate radio frequency energy and, if not installed and used in accordance with the instructions, may cause harmful interference to radio communications. However, there is no guarantee that interference will not occur in a particular installation. If this equipment does cause harmful interference to radio or television reception, which can be determined by turning the equipment off and on, the user is encouraged to try to correct the interference by one or more of the following measures:

- Reorient or relocate the receiving antenna.
- Increase the separation between the equipment and receiver.
- Connect the equipment into an outlet on a circuit different from that to which the receiver is connected.

IASO-W07A-N6210 Medical Panel PC

UL CLASSIFIED



The label on the product indicates this product complies with the requirements of ES 60601-1 (2005) + AMD (2012), CAN/CSA-C22.2 No. 60601-1:14.

ROHS STATEMENT



The label on the product indicates this product conforms to European (EU) Restriction of Hazardous Substances (RoHS) that set maximum concentration limits on hazardous materials used in electrical and electronic equipment.

CHINA ROHS



The label on the product indicates the estimated “Environmentally Friendly Use Period” (EFUP). This is an estimate of the number of years that these substances would “not leak out or undergo abrupt change.” This product may contain replaceable sub-assemblies/components which have a shorter EFUP such as batteries and lamps. These components will be separately marked.

Appendix

B

Product Disposal

**CAUTION / ATTENTION**

Risk of explosion if battery is replaced by an incorrect type. Only certified engineers should replace the on-board battery.

Risque d'explosion si la batterie est remplacée par un type incorrect.
Seuls les ingénieurs certifiés doivent remplacer la batterie embarquée.

Dispose of used batteries according to instructions and local regulations.

Jetez les piles usagées conformément aux instructions et aux réglementations locales.

- Outside the European Union - If you wish to dispose of used electrical and electronic products outside the European Union, please contact your local authority so as to comply with the correct disposal method.
- Within the European Union–The device that produces less waste and is easier to recycle is classified as electronic device in terms of the European Directive 2012/19/EU (WEEE), and must not be disposed of as domestic garbage.

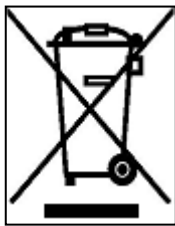

EU-wide legislation, as implemented in each Member State, requires that waste electrical and electronic products carrying the mark (left) must be disposed of separately from normal household waste. This includes monitors and electrical accessories, such as signal cables or power cords. When you need to dispose of your display products, please follow the guidance of your local authority, or ask the shop where you purchased the product. The mark on electrical and electronic products only applies to the current European Union Member States.

Please follow the national guidelines for electrical and electronic product disposal.

Appendix

C

Maintenance and Cleaning Precautions

IASO-W07A-N6210 Medical Panel PC

When maintaining or cleaning the IASO-W07A-N6210, please follow the guidelines below.



WARNING / AVERTISSEMENT

If you dropped any material or liquid such as water onto the panel PC when cleaning, unplug the power cable immediately and contact your dealer or the nearest service center. Always make sure your hands are dry when unplugging the power cable.

Si vous avez fait tomber du matériel ou du liquide tel que de l'eau sur le Panel PC lors du nettoyage, débranchez immédiatement le câble d'alimentation et contactez votre revendeur ou le centre de service le plus proche. Assurez-vous toujours que vos mains sont sèches lorsque vous débranchez le câble d'alimentation.



CAUTION / ATTENTION

- For safety reasons, turn-off the power switch and unplug the panel PC before cleaning.
Pour des raisons de sécurité, éteignez l'interrupteur d'alimentation et débranchez le Panel PC avant de le nettoyer.
- Do not scratch or rub the screen with a hard object.
Ne rayez pas et ne frottez pas l'écran avec un objet dur.
- Never use any of the following solvents on the medical panel PC. Harsh chemicals may cause damage to the cabinet and the touch sensor.
N'utilisez jamais l'un des solvants suivants sur le Panel PC médical. Les produits chimiques agressifs peuvent endommager le boîtier et le capteur tactile.
Thinner Spray-type cleaner, Benzene, Wax, Abrasive cleaner, Acid or Alkaline solvent.
Diluant nettoyant de type spray, benzène, cire, nettoyant abrasif, solvant acide ou alcalin.

C.1.1 Maintenance and Cleaning

Prior to cleaning any part or component of the IASO-W07A-N6210, please read the details below.

- To clean the IASO-W07A-N6210,
 - remove dirt with a lightly moistened cloth. Then wipe the external chassis with a soft dry cloth.
 - use 75% ethanol alcohol to clean the external chassis.
- Cleaning frequency: follow the cleaning method guidelines of the hospital.
- Except for the LCD panel, never spray or squirt liquids directly onto any other components.
- The interior of the IASO-W07A-N6210 does not require cleaning. Keep fluids away from the IASO-W07A-N6210 interior.

C.1.2 Cleaning Tools

Some components in the IASO-W07A-N6210 may only be cleaned using a product specifically designed for the purpose. In such case, the product will be explicitly mentioned in the cleaning tips. Below is a list of items to use when cleaning the IASO-W07A-N6210.















- **Cloth** – Although paper towels or tissues can be used, a soft, clean piece of cloth is recommended when cleaning the IASO-W07A-N6210.
- **Water/Ethanol alcohol** – A cloth moistened with water or 75% ethanol alcohol can be used to clean the IASO-W07A-N6210.
- **Using solvents** – The use of solvents is not recommended when cleaning the IASO-W07A-N6210 as they may damage the plastic parts.
- **Cotton swabs** - Cotton swabs moistened with water are excellent tools for wiping hard to reach areas.
- **Foam swabs** - Whenever possible, it is best to use lint free swabs such as foam swabs for cleaning.

Appendix

D

Symbol Definitions

The following symbols appear on the product, its labeling, or the product packing. Each symbol carries a special definition, as defined below:

	Direct current		Fragile, handle with care
	AC current		Keep dry
	Protective earth (ground)		This side up
	Date of manufacture		Indicates the manufacturer
	Stand-by		Refer to instruction manual
	Indicates proof of conformity to applicable European Economic Community Council directives and to harmonized standards published in the official journal of the European Communities.		
	Tested to comply with FCC Class B standard.		
	This symbol indicates that the waste of electronic equipment must not be disposed as unsorted municipal waste and must be collected separately. Please contact the manufacturer or other authorized disposal company to decommission your equipment.		
	This product is recyclable.		

Appendix

E

Watchdog Timer



NOTE:

The following discussion applies to DOS. Contact IEI support or visit the IEI website for drivers for other operating systems.

The Watchdog Timer is a hardware-based timer that attempts to restart the system when it stops working. The system may stop working because of external EMI or software bugs. The Watchdog Timer ensures that standalone systems like ATMs will automatically attempt to restart in the case of system problems.

A BIOS function call (INT 15H) is used to control the Watchdog Timer.

INT 15H:

AH – 6FH Sub-function:	
AL – 2:	Sets the Watchdog Timer's period.
BL:	Time-out value (Its unit-second is dependent on the item "Watchdog Timer unit select" in CMOS setup).

Table E-1: AH-6FH Sub-function

Call sub-function 2 to set the time-out period of Watchdog Timer first. If the time-out value is not zero, the Watchdog Timer starts counting down. When the timer value reaches zero, the system resets. To ensure that this reset condition does not occur, calling sub-function 2 must periodically refresh the Watchdog Timer. However, the watchdog timer is disabled if the time-out value is set to zero.

A tolerance of at least 10% must be maintained to avoid unknown routines within the operating system (DOS), such as disk I/O that can be very time-consuming.

IASO-W07A-N6210 Medical Panel PC

**NOTE:**

The Watchdog Timer is activated through software. The software application that activates the Watchdog Timer must also deactivate it when closed. If the Watchdog Timer is not deactivated, the system will automatically restart after the Timer has finished its countdown.

EXAMPLE PROGRAM:

; INITIAL TIMER PERIOD COUNTER

;

W_LOOP:

;

```

MOV      AX, 6F02H      ;setting the time-out value
MOV      BL, 30         ;time-out value is 48 seconds
INT      15H

```

;

; ADD THE APPLICATION PROGRAM HERE

;

```

CMP      EXIT_AP, 1     ;is the application over?
JNE      W_LOOP        ;No, restart the application

```

```

MOV      AX, 6F02H      ;disable Watchdog Timer
MOV      BL, 0          ;
INT      15H

```

;

; EXIT ;

Appendix

F

Error Beep Code

IASO-W07A-N6210 Medical Panel PC

F.1 PEI Beep Codes

Number of Beeps	Description
1	Memory not Installed
1	Memory was installed twice (InstallPeiMemory routine in PEI Core called twice)
2	Recovery started
3	DXEIPL was not found
3	DXE Core Firmware Volume was not found
4	Recovery failed
4	S3 Resume failed
7	Reset PPI is not available

F.2 DXE Beep Codes

Number of Beeps	Description
1	Invalid password
4	Some of the Architectural Protocols are not available
5	No Console Output Devices are found
5	No Console Input Devices are found
6	Flash update is failed
7	Reset protocol is not available
8	Platform PCI resource requirements cannot be met



NOTE:

If you have any question, please contact IEI for further assistance.

Appendix

G

Hazardous Materials Disclosure

IASO-W07A-N6210 Medical Panel PC

G.1 RoHS II Directive (2015/863/EU)

The details provided in this appendix are to ensure that the product is compliant with the RoHS II Directive (2015/863/EU). The table below acknowledges the presences of small quantities of certain substances in the product, and is applicable to RoHS II Directive (2015/863/EU).

Please refer to the following table.

Part Name	Toxic or Hazardous Substances and Elements									
	Lead (Pb)	Mercury (Hg)	Cadmium (Cd)	Hexavalent Chromium (CR(VI))	Polybrominated Biphenyls (PBBs)	Polybrominated Diphenyl Ethers (PBDEs)	Bis(2-ethylhexyl) phthalate (DEHP)	Butyl benzyl phthalate (BBP)	Dibutyl phthalate (DBP)	Diisobutyl phthalate (DIBP)
Housing	O	O	O	O	O	O	O	O	O	O
Display	O	O	O	O	O	O	O	O	O	O
Printed Circuit Board	O	O	O	O	O	O	O	O	O	O
Metal Fasteners	O	O	O	O	O	O	O	O	O	O
Cable Assembly	O	O	O	O	O	O	O	O	O	O
Fan Assembly	O	O	O	O	O	O	O	O	O	O
Power Supply Assemblies	O	O	O	O	O	O	O	O	O	O
Battery	O	O	O	O	O	O	O	O	O	O

O: This toxic or hazardous substance is contained in all of the homogeneous materials for the part is below the limit requirement in Directive (EU) 2015/863.

X: This toxic or hazardous substance is contained in at least one of the homogeneous materials for this part is above the limit requirement in Directive (EU) 2015/863.

G.2 China RoHS

此附件旨在确保本产品符合中国 RoHS 标准。以下表格标示此产品中某有毒物质的含量符合中国 RoHS 标准规定的限量要求。

本产品上会附有“环境友好使用期限”的标签，此期限是估算这些物质“不会有泄漏或突变”的年限。本产品可能包含有较短的环境友好使用期限的可替换元件，像是电池或灯管，这些元件将会单独标示出来。

部件名称	有毒有害物质或元素					
	铅 (Pb)	汞 (Hg)	镉 (Cd)	六价铬 (CR(VI))	多溴联苯 (PBB)	多溴二苯醚 (PBDE)
壳体	○	○	○	○	○	○
显示	○	○	○	○	○	○
印刷电路板	○	○	○	○	○	○
金属螺帽	○	○	○	○	○	○
电缆组装	○	○	○	○	○	○
风扇组装	○	○	○	○	○	○
电力供应组装	○	○	○	○	○	○
电池	○	○	○	○	○	○
<p>○: 表示该有毒有害物质在该部件所有物质材料中的含量均在 SJ/T11364-2014 與 GB/T26572-2011 标准规定的限量要求以下。</p> <p>X: 表示该有毒有害物质至少在该部件的某一均质材料中的含量超出 SJ/T11364-2014 與 GB/T26572-2011 标准规定的限量要求。</p>						