



MODEL:  
**PUZZLE-IN003A**

**Desktop Network Appliance with Intel® Atom® C3000 Series Processor, DDR4, Six/Eight GbE Ports, Two M.2, PCIe Mini, Fanless, Rack Mount and RoHS Compliant**

# User Manual

# Revision

---

Date	Version	Changes
October 19, 2020	1.00	Initial release

# Copyright

---

## **COPYRIGHT NOTICE**

The information in this document is subject to change without prior notice in order to improve reliability, design and function and does not represent a commitment on the part of the manufacturer.

In no event will the manufacturer be liable for direct, indirect, special, incidental, or consequential damages arising out of the use or inability to use the product or documentation, even if advised of the possibility of such damages.

This document contains proprietary information protected by copyright. All rights are reserved. No part of this manual may be reproduced by any mechanical, electronic, or other means in any form without prior written permission of the manufacturer.

## **TRADEMARKS**

All registered trademarks and product names mentioned herein are used for identification purposes only and may be trademarks and/or registered trademarks of their respective owners.

# Manual Conventions

---



## **WARNING**

Warnings appear where overlooked details may cause damage to the equipment or result in personal injury. Warnings should be taken seriously.



## **CAUTION**

Cautionary messages should be heeded to help reduce the chance of losing data or damaging the product.



## **NOTE**

These messages inform the reader of essential but non-critical information. These messages should be read carefully as any directions or instructions contained therein can help avoid making mistakes.

# Table of Contents

<b>1 INTRODUCTION.....</b>	<b>1</b>
1.1 OVERVIEW.....	2
1.2 MODEL VARIATIONS .....	3
1.3 FEATURES.....	3
1.4 FRONT PANEL.....	4
1.5 REAR PANEL.....	5
1.6 DIMENSIONS.....	5
1.7 TECHNICAL SPECIFICATIONS .....	6
<b>2 UNPACKING .....</b>	<b>8</b>
2.1 ANTI-STATIC PRECAUTIONS .....	9
2.2 UNPACKING PRECAUTIONS.....	9
2.3 PACKING LIST.....	10
2.4 OPTIONAL ITEMS .....	11
<b>3 INSTALLATION .....</b>	<b>12</b>
3.1 INSTALLATION PRECAUTIONS .....	13
3.2 TOP COVER REMOVAL .....	14
3.3 DIMM INSTALLATION .....	14
3.4 M.2 MODULE INSTALLATION.....	16
3.5 PCIe MINI CARD INSTALLATION .....	17
3.5.1 <i>Half-size PCIe Mini Card Installation</i> .....	18
3.5.2 <i>SIM Card Installation</i> .....	18
3.6 EXTERNAL INTERFACE CONNECTION .....	21
3.6.1 <i>LAN Connection - 1GbE</i> .....	22
3.6.2 <i>Console Connection</i> .....	23
3.6.2.1 <i>Enable Console Port When Booting</i> .....	23
3.7 MOUNTING THE SYSTEM .....	26
3.8 POWER-ON PROCEDURE.....	26
3.9 RESOURCE DOWNLOAD.....	28
3.10 SYSTEM CONFIGURATION.....	28

3.10.1 Bypass Configuration in BIOS.....	29
3.10.2 Jumper Settings.....	30
3.10.2.1 Clear CMOS.....	30
3.10.2.2 Flash Descriptor Security Override Jumper.....	31
<b>4 BIOS .....</b>	<b>33</b>
4.1 INTRODUCTION.....	34
4.1.1 Starting Setup.....	34
4.1.2 Using Setup.....	34
4.1.3 Getting Help.....	35
4.1.4 Unable to Reboot after Configuration Changes .....	35
4.1.5 BIOS Menu Bar.....	35
4.2 MAIN.....	36
4.3 ADVANCED.....	37
4.3.1 Trusted Computing.....	38
4.3.2 IT8528 Super IO Configuration.....	39
4.3.2.1 Serial Port 1 Configuration.....	39
4.3.3 iWDD H/W Monitor.....	40
4.3.4 Serial Port Console Redirection .....	41
4.3.4.1 Legacy Console Redirection Settings .....	44
4.3.5 NVMe Configuration.....	45
4.4 INTELRCSETUP .....	45
4.4.1 Processor Configuration .....	46
4.4.1 North Bridge Chipset Configuration .....	47
4.4.1 South Bridge Chipset Configuration .....	48
4.4.1.1 SATA Configuration.....	48
4.4.1.2 PCIE IP Configuration .....	49
4.4.1.3 Network Configuration.....	50
4.5 SECURITY.....	51
4.6 BOOT.....	52
4.7 SAVE & EXIT .....	54
<b>5 INTERFACE CONNECTORS .....</b>	<b>55</b>
5.1 PERIPHERAL INTERFACE CONNECTORS.....	56
5.2 INTERNAL PERIPHERAL CONNECTORS .....	57

**PUZZLE-IN003A**

5.2.1 Battery Connector (BAT1) .....	58
5.2.2 CPLD Programmer Connector (J8) .....	58
5.2.3 Debug Port (DBG_PORT1).....	58
5.2.4 Fan Connectors (CPU_FAN1 & SYS_FAN1).....	59
5.2.5 LCM Connectors (CN7).....	59
5.2.6 M.2 A-key Slot (M2_CN1).....	59
5.2.7 M.2 M-key Slot (M2_MI).....	61
5.2.8 M.2 Power Connector (M2_PWR1).....	62
5.2.9 PCIe Mini Card Slot (MINI_PCIE1) .....	63
5.2.10 Power Button Connector (PWR_BTN1) .....	64
5.2.11 SATA Connector (SATA1).....	64
5.2.12 SATA Power Connector (SATA_PWR1).....	64
5.2.13 SMBus Connector (JP5) .....	64
5.2.14 SPI Flash Connector (J1) .....	65
5.2.15 SPI Flash Connector - EC (J7).....	65
5.2.16 SVID Connector (JP2).....	65
5.2.17 TPM Connector (TPM1).....	66
<b>A REGULATORY COMPLIANCE .....</b>	<b>67</b>
<b>B SAFETY PRECAUTIONS .....</b>	<b>72</b>
B.1 SAFETY PRECAUTIONS.....	73
B.1.1 General Safety Precautions .....	73
B.1.2 Anti-static Precautions .....	73
B.1.3 Product Disposal .....	74
B.2 MAINTENANCE AND CLEANING PRECAUTIONS .....	75
B.2.1 Maintenance and Cleaning.....	75
B.2.2 Cleaning Tools.....	75
<b>C HAZARDOUS MATERIALS DISCLOSURE .....</b>	<b>77</b>
C.1 RoHS II DIRECTIVE (2015/863/EU) .....	78
C.2 CHINA RoHS.....	79

# List of Figures

---

Figure 1-1: PUZZLE-IN003A Series .....	2
Figure 1-2: Front Panel .....	4
Figure 1-3: Rear Panel.....	5
Figure 1-4: Physical Dimensions (millimeters).....	5
Figure 3-1: Top Cover Removal .....	14
Figure 3-2: DIMM Slot Locations.....	15
Figure 3-3: PCIe Mini Slot Location .....	17
Figure 3-4: SIM Card Slot Location.....	19
Figure 3-5: Unlock SIM Card Slot Cover .....	19
Figure 3-6: SIM Card Installation.....	20
Figure 3-7: Lock SIM Card Slot Cover .....	20
Figure 3-8: RJ-45 1GbE Connector .....	22
Figure 3-9: Rack Mounting Bracket Installation .....	26
Figure 3-10: Power-on.....	27
Figure 3-11: IEI Resource Download Center.....	28
Figure 3-12: Clear CMOS Button Location.....	31
Figure 3-13: Flash Descriptor Security Override Jumper Location .....	31



# List of Tables

Table 1-1: PUZZLE-IN003A Model Variations .....	3
Table 1-2: Technical Specifications.....	7
Table 3-1: 1GbE Port Pinouts .....	22
Table 3-2: RJ-45 1GbE Connector LEDs .....	22
Table 3-3: RJ-45 Serial Port Pinouts.....	23
Table 3-4: Flash Descriptor Security Override Jumper Settings.....	31
Table 4-1: BIOS Navigation Keys .....	35
Table 5-1: Battery Connector (BAT1) Pinouts .....	58
Table 5-2: CPLD Programmer Connector (J8) Pinouts.....	58
Table 5-3: Debug Port (DBG_PORT1) Pinouts.....	58
Table 5-4: Fan Connectors (CPU_FAN1 & SYS_FAN1) Pinouts .....	59
Table 5-5: LCM Connectors (CN7) Pinouts .....	59
Table 5-6: M.2 A-key Slot (M2_CN1) Pinouts .....	60
Table 5-7: M.2 M-key Slot (M2_M1) Pinouts .....	62
Table 5-8: M.2 Power Connector (M2_PWR1) Pinouts.....	62
Table 5-9: PCIe Mini Card Slot (MINI_PCIE1) Pinouts.....	63
Table 5-10: Power Button Connector (PWR_BTN1) Pinouts.....	64
Table 5-11: SATA 6Gb/s Connector (SATA1) Pinouts .....	64
Table 5-12: SATA Power Connector (SATA_PWR1) Pinouts .....	64
Table 5-13: SMBus Connector (JP5) Pinouts .....	64
Table 5-14: SPI Flash Connector (J1) Pinouts.....	65
Table 5-15: SPI Flash Connector (J7) Pinouts.....	65
Table 5-16: SVID Connector (JP2) Pinouts .....	65



Chapter

1

# Introduction

---

## 1.1 Overview



**Figure 1-1: PUZZLE-IN003A Series**

The PUZZLE-IN003A is a compact desktop network appliance series powered by Intel® Atom® C3558/C3336 processor. It is optimized to host VNFs (Virtual Network Functions) and is ideal for SD-WAN.

The PUZZLE-IN003A supports six/eight copper GbE ports for high-speed network applications. WWAN capability provided by the on-board PCIe Mini slot and the SIM card slot ensures smooth network connectivity.

It is also equipped with one M.2 M-key (2260/2280) slot to support PCIe SSD and one SATA 6Gb/s connector to support SATADOM, providing a variety of storage interfaces for users to choose.

**PUZZLE-IN003A****1.2 Model Variations**

The model variations of the PUZZLE-IN003A are listed below.

	<b>CPU</b>	<b>LAN Port</b>	<b>DIMM</b>
PUZZLE-IN003A-C1	Intel® Atom® C3558 (up to 2.20 GHz, 8M cache)	8 x GbE 2 bypass	2 x DDR4 slot
PUZZLE-IN003A-C1/8G	Intel® Atom® C3558 (up to 2.20 GHz, 8M cache)	8 x GbE 2 bypass	2 x DDR4 slot 8GB pre-installed
PUZZLE-IN003A-C3	Intel® Atom® C3336 (1.50 GHz, 4M cache)	6 x GbE 1 bypass	1 x DDR4 slot
PUZZLE-IN003A-C3/8G	Intel® Atom® C3336 (1.50 GHz, 4M cache)	6 x GbE 1 bypass	1 x DDR4 slot 8GB pre-installed

**Table 1-1: PUZZLE-IN003A Model Variations**

**1.3 Features**

The PUZZLE-IN003A features are listed below:

- Powered by Intel® Atom® C3000 series processor
- Support up to two 2133 MHz DDR4 ECC/non-ECC UDIMM/RDIMM (UDIMM up to 64 GB / RDIMM up to 128 GB)
- Supports up to eight GbE connections via Intel® I211-AT Ethernet controllers and Marvell 88E1543 PHY
- Upgradable with future expansion cards by one M.2 M-key slot, one M.2 A-key slot and one PCIe Mini card slot
- One RJ-45 console port
- Supports one USB 3.2 Gen 1 (5Gb/s) port and one USB 2.0 port
- Supports SATADOM
- RoHS compliant

## 1.4 Front Panel

The overview of the front panel is shown in **Figure 1-2**.

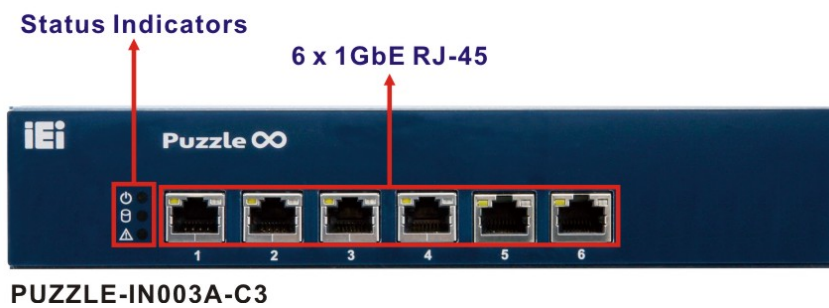
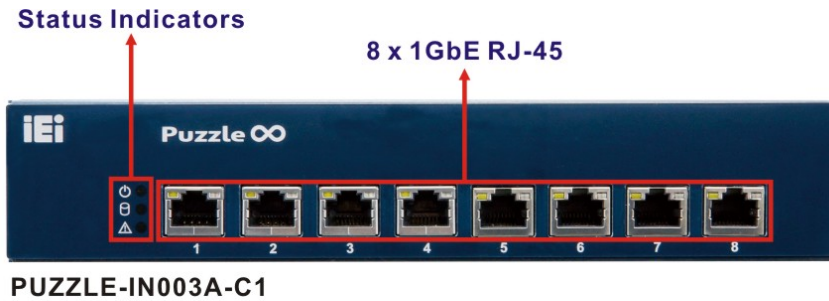

**Figure 1-2: Front Panel**

The states of the LED indicators located on the front panel are listed below.

 <b>Power LED</b>	Off	The system is turned off.
	Blue	The system is turned on.
 <b>SSD Status LED</b>	Off	No SSD activity
	Blinking Green	SSD activity
 <b>Alert LED</b>	Off	No alert
	Red	Alert message

## PUZZLE-IN003A

### 1.5 Rear Panel

An overview of the PUZZLE-IN003A rear panel is shown in **Figure 1-3** below.



Figure 1-3: Rear Panel

### 1.6 Dimensions

The physical dimensions are shown below:

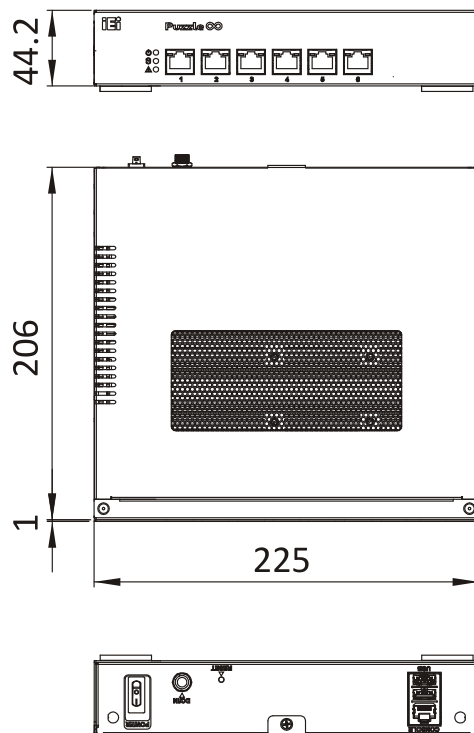

Figure 1-4: Physical Dimensions (millimeters)

## 1.7 Technical Specifications

The PUZZLE-IN003A technical specifications are listed in **Table 1-2**.

	<b>PUZZLE-IN003A-C1</b>	<b>PUZZLE-IN003A-C3</b>
<b>CPU (SoC)</b>	Intel® Atom® C3558 (up to 2.20 GHz, 8M cache)	Intel® Atom® C3336 (1.50 GHz, 4M cache)
<b>Chipset</b>	Integrated in CPU	
<b>Memory</b>	288-pin 2133 MHz DDR4 ECC/non-ECC UDIMM/RDIMM slot(s) (UDIMM up to 64 GB / RDIMM up to 128 GB)	
	2 x DDR4 DIMM slots	1 x DDR4 DIMM slot
<b>Networking</b>	4 x GbE LAN port (by Intel® I211-AT)	4 x GbE LAN port (by Intel® I211-AT)
	4 x GbE LAN port (by Marvell 88E1543)	2 x GbE LAN port (by Marvell 88E1543)
	2 bypass segments	1 bypass segment
<b>Network Acceleration and Security</b>	<ul style="list-style-type: none"> <li>• Intel® AES New Instructions</li> <li>• Intel® Software Guard Extensions (Intel® SGX)</li> <li>• Intel® Virtualization Technology for Directed I/O (VT-d)</li> <li>• Intel® QuickAssist Technology (Intel® QAT)</li> </ul>	<ul style="list-style-type: none"> <li>• Intel® Virtualization Technology for Directed I/O (VT-d)</li> <li>• Intel® Virtualization Technology (VT-x)</li> <li>• Intel® QuickAssist Technology (Intel® QAT)</li> </ul>
<b>Storage</b>	1 x SATA 6Gb/s connector (with one 5 V SATA power connector) for SATADOM	
	1 x M.2 2260/2280 M-key slot (supports PCIe 3.0 x4 nVME)	
<b>eMMC</b>	32 GB eMMC	
<b>Expansions</b>		
<b>PCIe Mini</b>	1 x Full-size/Half-size PCIe Mini slot (USB 2.0, PCIe 3.0 x1) with SIM card slot	
<b>M.2</b>	1 x M.2 2230 A-key slot (USB 2.0, PCIe 3.0 x1)	



## PUZZLE-IN003A

I/O and Indicators		
<b>Console</b>	1 x RJ-45	
<b>USB</b>	1 x USB 3.2 Gen 1 (5 Gb/s) port (external, Type A) 1 x USB 2.0 port (external, Type A)	
<b>Indicator</b>	Power status (blue) SSD status (green) Alert LED (programmable, red)	
<b>Switch/Button</b>	Power switch Reset button	
<b>TPM</b>	1 x TPM 2.0 (2x10 pin header)	
<b>Antenna Connector</b>	2 x Knockout hole for Wi-Fi/WWAN antenna connector	
Power		
<b>Power Input</b>	1 x DC-in jack	
<b>Type/Watt</b>	12 V DC-in, 60 W	
<b>Thermal Solution</b>	<b>CPU</b>	Passive heat sink for CPU
	<b>System</b>	Fanless system
Environmental and Mechanical		
<b>Mounting</b>	Desktop, rack mount	
<b>Operating Temperature</b>	0°C~40°C (32°F~104°F)	
<b>Storage Temperature</b>	-20°C~75°C (-4°F~167°F)	
<b>Operating Humidity</b>	5%~90%, non-condensing	
<b>Safety</b>	CE, FCC	
<b>Weight</b>	2 kg	
<b>Physical Dimensions</b>	225.0 mm x 206.0 mm x 44.2 mm (W x D x H)	
<b>Operating System</b>	Linux Ubuntu 18.04.04 CentOS 7 / Red Hat / Fedora EPEL Microsoft Windows 10	

Table 1-2: Technical Specifications

Chapter

2

# Unpacking

---

## PUZZLE-IN003A

### 2.1 Anti-static Precautions

---



#### **WARNING:**

Failure to take ESD precautions during installation may result in permanent damage to the PUZZLE-IN003A and severe injury to the user.

---

Electrostatic discharge (ESD) can cause serious damage to electronic components, including the PUZZLE-IN003A. Dry climates are especially susceptible to ESD. It is therefore critical that whenever the PUZZLE-IN003A or any other electrical component is handled, the following anti-static precautions are strictly adhered to.

- ***Wear an anti-static wristband:*** Wearing a simple anti-static wristband can help to prevent ESD from damaging the board.
- ***Self-grounding:*** Before handling the board, touch any grounded conducting material. During the time the board is handled, frequently touch any conducting materials that are connected to the ground.
- ***Use an anti-static pad:*** When configuring the PUZZLE-IN003A, place it on an anti-static pad. This reduces the possibility of ESD damaging the PUZZLE-IN003A.

### 2.2 Unpacking Precautions

When the PUZZLE-IN003A is unpacked, please do the following:

- Follow the anti-static precautions outlined in **Section 2.1**.
- Make sure the packing box is facing upwards so the PUZZLE-IN003A does not fall out of the box.
- Make sure all the components shown in **Section 2.3** are present.





## 2.3 Packing List





**NOTE:**

If some of the components listed in the checklist below are missing, please do not proceed with the installation. Contact the IEI reseller or vendor you purchased the PUZZLE-IN003A from or contact an IEI sales representative directly. To contact an IEI sales representative, please send an email to [sales@ieiworld.com](mailto:sales@ieiworld.com).

The PUZZLE-IN003A is shipped with the following components:



Quantity	Item	Image
1	PUZZLE-IN003A	
1	Power cord	
1	Power adapter	
1	USB to console cable (only for SKUs with memory)	
1	RS-232 to console cable (only for SKUs without memory)	

## PUZZLE-IN003A

Quantity	Item	Image
2	Rack mounting bracket	
6	Mounting bracket screw (M4*6)	

## 2.4 Optional Items

The following table lists the optional items that can be purchased separately.

Optional Item	Image
USB to console cable (P/N: 32013-004000-100-RS)	
RS-232 to console cable (P/N: 32005-005100-100-RS)	
20-pin Infineon SPI TPM 2.0 module, software management tool, firmware v7.63 (P/N: TPM-IN03-R10)	

Chapter

**3**

# Installation

---

## PUZZLE-IN003A

### 3.1 Installation Precautions

During installation, be aware of the precautions below:

- **Read the user manual:** The user manual provides a complete description of the PUZZLE-IN003A, installation instructions and configuration options.
- **DANGER! Disconnect Power:** Power to the PUZZLE-IN003A must be disconnected during the installation process. Failing to disconnect the power may cause severe injury to the body and/or damage to the system.
- **Qualified Personnel:** The PUZZLE-IN003A must be installed and operated only by trained and qualified personnel. Maintenance, upgrades, or repairs may only be carried out by qualified personnel who are familiar with the associated dangers.
- **Air Circulation:** Make sure there is sufficient air circulation when installing the PUZZLE-IN003A. The PUZZLE-IN003A's cooling vents must not be obstructed by any objects. Blocking the vents can cause overheating of the PUZZLE-IN003A. Leave at least 5 cm of clearance around the PUZZLE-IN003A to prevent overheating.
- **Grounding:** The PUZZLE-IN003A should be properly grounded. The voltage feeds must not be overloaded. Adjust the cabling and provide external overcharge protection per the electrical values indicated on the label attached to the back of the PUZZLE-IN003A.

## 3.2 Top Cover Removal

Before installing or maintaining the internal components, the top cover must be removed from the PUZZLE-IN003A. Follow the steps below to complete the task.

**Step 1:** Remove the retention screw indicated in **Figure 3-1**.

**Step 2:** Slide the top cover towards the rear side and gently lift the top cover (Figure 3-1).



Figure 3-1: Top Cover Removal

## 3.3 DIMM Installation



### CAUTION:

For multi-channel configuration, always install the identical memory modules that feature the same capacity, timings, voltage, number of ranks and the same brand.

---



## PUZZLE-IN003A

To install the DIMM module, please follow the steps below.

- Step 1:** Remove the top cover from the PUZZLE-IN003A. Please follow the instruction described in **Section 3.2**.
- Step 2:** Locate the DIMM slot(s) on the motherboard. C1 SKU has two DIMM slots; C3 SKU has one DIMM slot.

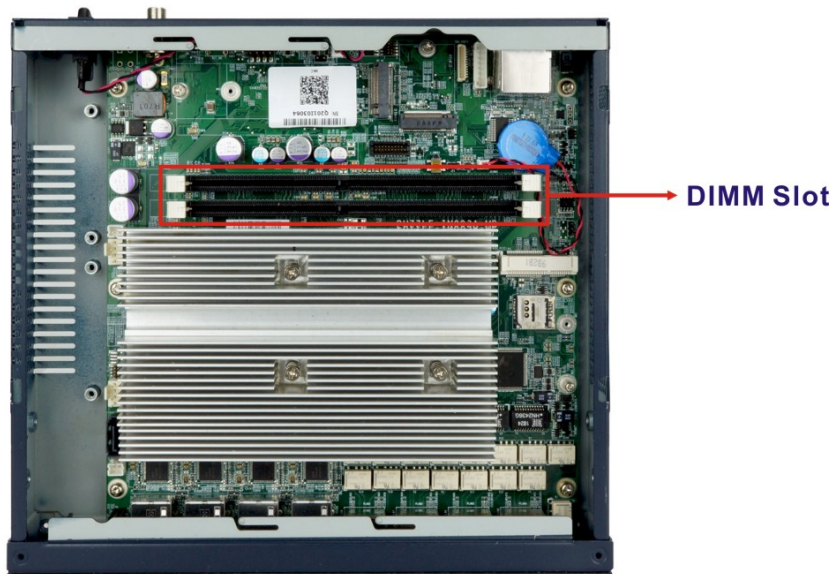

**Figure 3-2: DIMM Slot Locations**

- Step 3:** Open the DIMM socket handles. Open the two handles outwards as far as they can.
- Step 4:** Align the DIMM so the notch on the memory lines up with the notch on the memory socket.
- Step 5:** Once aligned, press down until the DIMM is properly seated. Clip the two handles into place.
- Step 6:** To remove a DIMM, push both handles outward. The memory module is ejected by a mechanism in the socket.

### 3.4 M.2 Module Installation

To install an M.2 module, please follow the steps below.

**Step 1:** Remove the top cover from the PUZZLE-IN003A. See **Section 3.2**.

**Step 2:** Locate the M.2 slots on the motherboard.

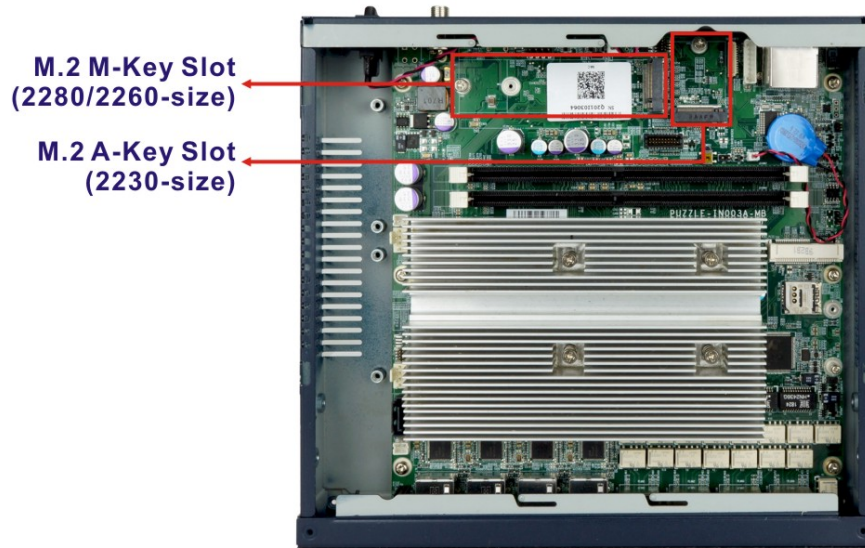

**Step 3:** Remove the on-board retention screw.

**Step 4:** Line up the notch on the module with the notch on the slot. Slide the M.2 module into the socket at an angle of about 20°.

**Step 5:** Push the M.2 module down and secure it with the previously removed retention screw.

## PUZZLE-IN003A

### 3.5 PCIe Mini Card Installation

The PUZZLE-IN003A has one full-size/half-size PCIe Mini slot on the motherboard. To install a full-size module, follow the instructions below.

**Step 1:** Remove the top cover from the PUZZLE-IN003A. See **Section 3.2**.

**Step 2:** Locate the PCIe Mini slot on the motherboard (**Figure 3-3**).

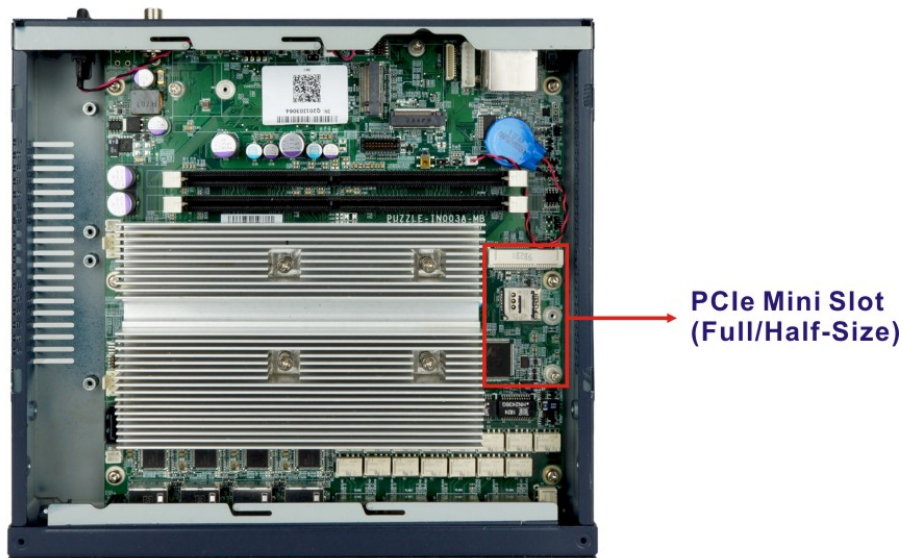

**Figure 3-3: PCIe Mini Slot Location**

**Step 3:** Remove the pre-installed retention screw from the standoff for a full-size PCIe Mini card.

**Step 4:** Line up the notch on the card with the notch on the slot. Slide the PCIe Mini card into the socket at an angle of about 20°.

**Step 5:** Secure the full-size PCIe Mini card with the retention screw previously removed.

### 3.5.1 Half-size PCIe Mini Card Installation

The PCIe Mini slot also allows installation of a half-size PCIe Mini card. To install a half-size PCIe Mini card, please follow the steps below.

- Step 1:** Unscrew and remove the screw and the standoff secured on the motherboard for the full-size PCIe Mini card installation.
- Step 2:** Install the previously removed standoff to the screw hole for the half-size PCIe Mini card.
- Step 3:** Line up the notch on the card with the notch on the slot. Slide the PCIe Mini card into the socket at an angle of about 20°.
- Step 4:** Secure the half-size PCIe Mini card with the retention screw previously removed.

### 3.5.2 SIM Card Installation

**NOTE:**

A WWAN module must be installed in the PCIe Mini slot (MINI\_PCIE1) to provide WWAN communication.

---

To install a SIM card, please follow the steps below.

- Step 1:** Remove the top cover from the PUZZLE-IN003A. See **Section 3.2**.
- Step 2:** Locate the SIM card slot on the motherboard (**Figure 3-4**).

PUZZLE-IN003A

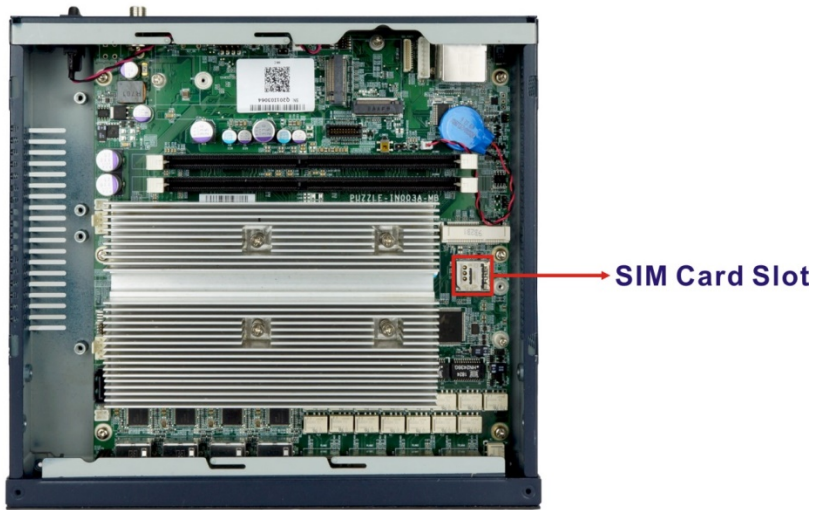

Figure 3-4: SIM Card Slot Location

**Step 3:** Unlock the SIM card slot cover by sliding the cover in the direction as shown by the arrow in **Figure 3-5**.



Figure 3-5: Unlock SIM Card Slot Cover

**Step 4:** Open the slot cover and place a SIM card onto the slot. The cut mark on the corner should be facing away from the slot as shown in **Figure 3-6**.

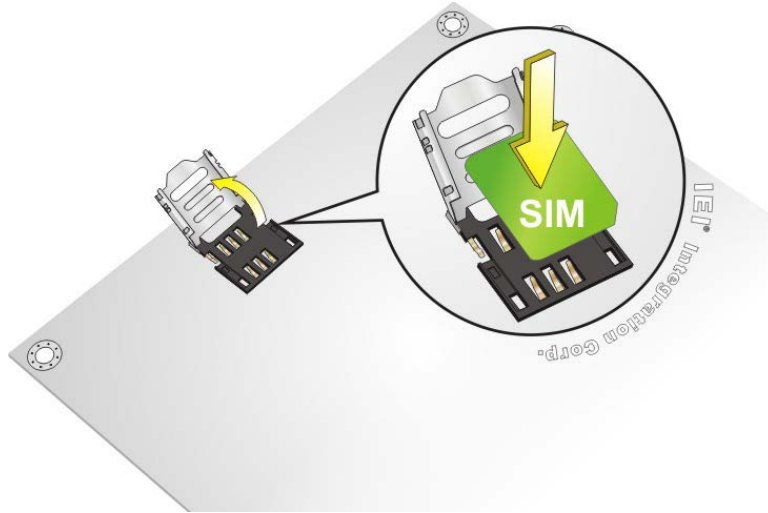

**Figure 3-6: SIM Card Installation**

**Step 5:** Close the slot cover and lock it by sliding it in the direction as shown by the arrow in **Figure 3-7**.

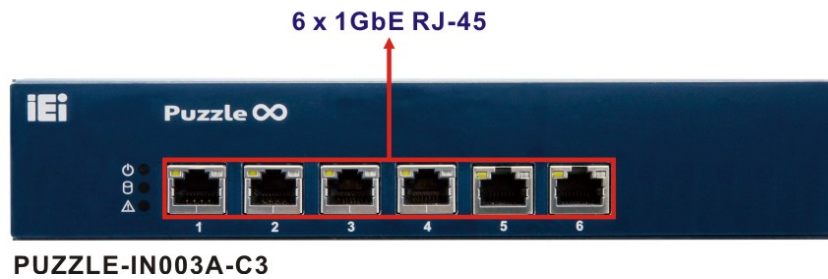
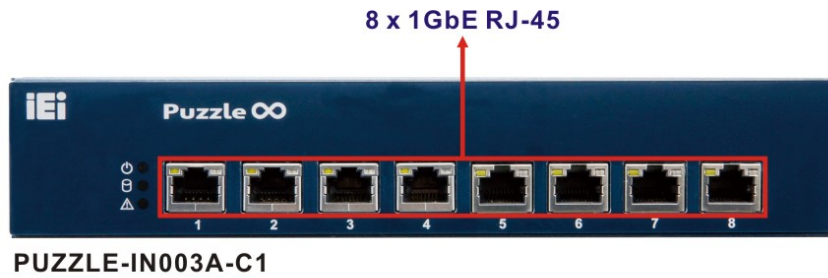

**Figure 3-7: Lock SIM Card Slot Cover**

## PUZZLE-IN003A

### 3.6 External Interface Connection

The front panel has several external I/O ports. The pinouts of these I/O ports are listed in the following sections.



### 3.6.1 LAN Connection - 1GbE

The 1GbE LAN connectors on the front panel allow connection to an external network. The pinouts of the LAN connectors are listed below.

Pin	Description	Pin	Description
1	MDIA3-	5	MDIA1+
2	MDIA3+	6	MDIA2+
3	MDIA2-	7	MDIA0-
4	MDIA1-	8	MDIA0+

**Table 3-1: 1GbE Port Pinouts**

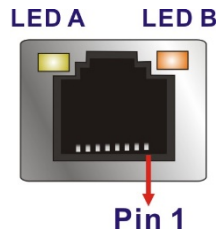

**Figure 3-8: RJ-45 1GbE Connector**

The RJ-45 Ethernet connector has two status LEDs, one yellow and one green/orange. The yellow LED indicates activity on the port and the green/orange LED indicates the speed. See **Table 3-2**.

LED	Description	LED	Description
A	on: linked blinking: data is being sent/received	B	off: 10 Mb/s green: 100 Mb/s orange: 1000 Mb/s

**Table 3-2: RJ-45 1GbE Connector LEDs**



## PUZZLE-IN003A

### 3.6.2 Console Connection

The PUZZLE-IN003A has one RJ-45 serial device connector on the front panel. The RJ-45 connector for the serial port can be identified easily as the RJ-45 for the network has two LEDs on the port, while the connectors for the serial cables don't. The pinouts of the serial port are listed below.

Pin	Description	Pin	Description
1	NRTS1	5	GND
2	NDTR1	6	NSIN1
3	NSOUT1	7	NDSR1
4	GND	8	NCTS1

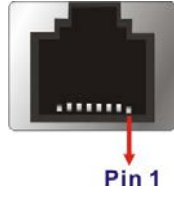

**Table 3-3: RJ-45 Serial Port Pinouts**

The serial device slot (RJ-45) connects to a cable with a standard D-sub 9 connector or a USB connector (varied from SKU) at the other end.

#### 3.6.2.1 Enable Console Port When Booting

To configure the PUZZLE-IN003A to make it auto enable the console port when booting, follow the steps below.



#### NOTE:

This method only works in Linux Ubuntu, the default operating system.

**Step 1:** Use the console cable shipped with the product to connect the RJ-45 console port of the PUZZLE-IN003A with your PC.

**Step 2:** In your PC, go to Windows **Device Manager** and check for the serial line of the connected USB serial port. In this case, it is COM3.

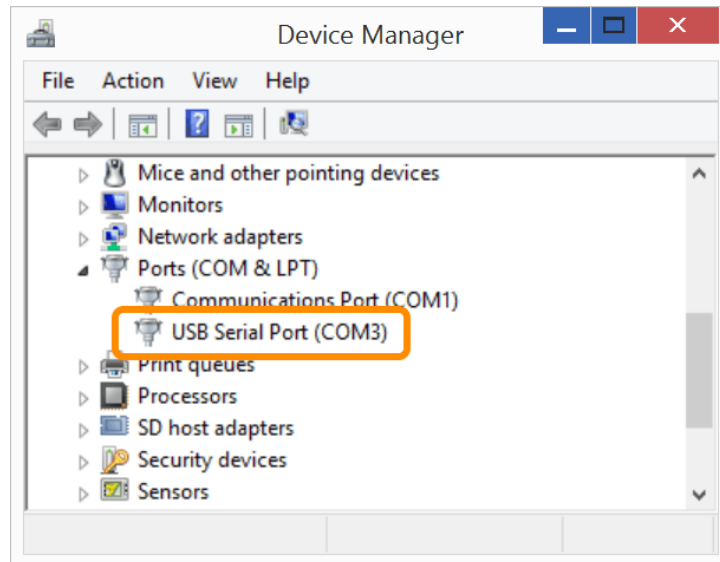

**Step 3:** Open a serial console application, PuTTY, as an example.

**Step 4:** Set the speed of the serial connection to “115200”, and choose “Serial” for Connection Type.

**Step 5:** Click “Open” on PuTTY.

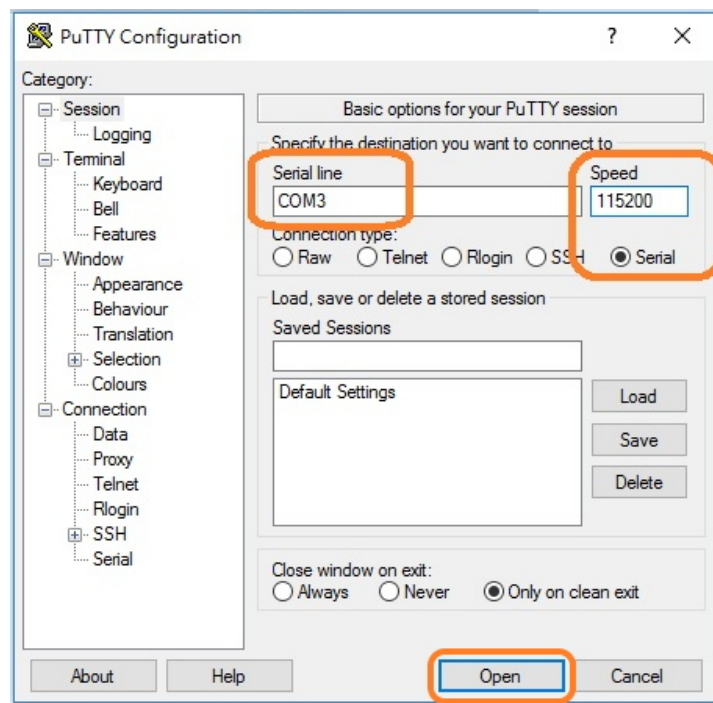

## PUZZLE-IN003A

**Step 6:** Enter the following command:

```
sudo vi /lib/systemd/system/ttyS0.service
```

**Step 7:** Ensure the information shown match the followings:

```
[Unit]
```

```
Description=Serial Console Service
```

```
[Service]
```

```
ExecStart=/sbin/getty -L 115200 ttyS0 vt102
```

```
Restart=always
```

```
[Install]
```

```
WantedBy=multi-user.target
```

**Step 8:** Run the following commands one by one:

```
sudo systemctl daemon-reload
```

```
sudo systemctl enable ttyS0
```

```
sudo systemctl start ttyS0
```

### 3.7 Mounting the System

The PUZZLE-IN003A is shipped with two mounting brackets that support 1U rack mount. To install the mounting brackets, please follow the steps below.

- Step 1:** Align the three retention screw holes in each bracket with the corresponding retention screw holes on the sides of the PUZZLE-IN003A.
- Step 2:** Secure the brackets to the system by inserting three retention screws (M4\*6) into each bracket (**Figure 3-9**). Make sure the screws are tight and on the right positions.



Figure 3-9: Rack Mounting Bracket Installation

### 3.8 Power-On Procedure



**WARNING:**

Make sure a power supply with the correct input voltage is being fed into the system. Incorrect voltages applied to the system may cause damage to the internal electronic components and may also cause injury to the user.

## PUZZLE-IN003A

**NOTE:**

Due to the limitation of Intel® Atom® C3000 processor, the **first boot time** after installing/re-installing a memory module can be greatly affected by the capacity of the installed memory module(s). The bigger the capacity, the longer it takes. Please wait patiently.

To power-on the PUZZLE-IN003A please follow the steps below:

- Step 1:** Connect the power adapter shipped with the PUZZLE-IN003A to the power jack on the rear panel.
- Step 2:** Use a power cord to connect the power adapter and the power source.
- Step 3:** Turn on the power switch to power up the system.
- Step 4:** The power LED indicator on the front panel turns to green.
- Step 5:** Use the following information when prompted for the username and password for login to the system.

**Username:** puzzle

**Password:** admin



Figure 3-10: Power-on

### 3.9 Resource Download

All the resources for the PUZZLE-IN003A are available on IEI Resource Download Center (<https://download.ieiworld.com>). Type PUZZLE-IN003A and press Enter to find all the relevant software, utilities, and documentation.

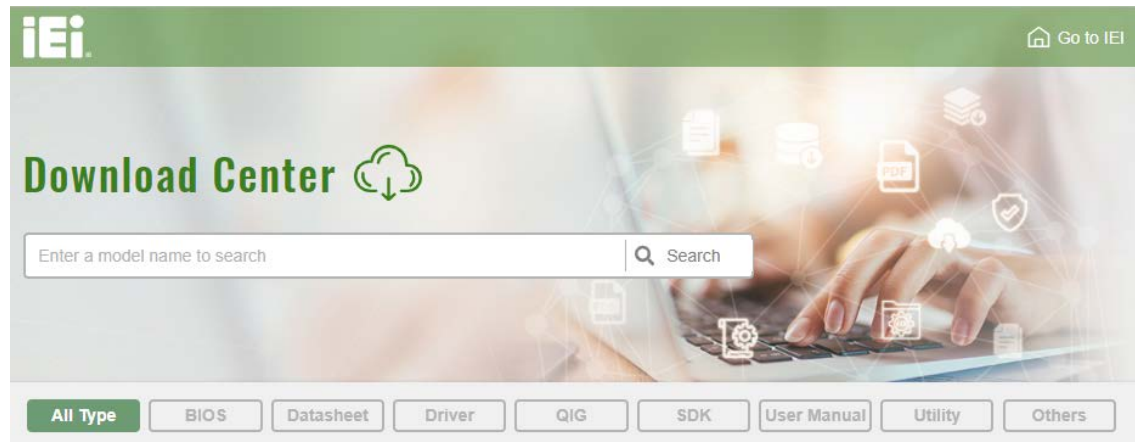

Figure 3-11: IEI Resource Download Center

### 3.10 System Configuration



#### **WARNING:**

The following instructions should only be performed by an authorized and trained technician.

Before starting, please ensure that you turn off the PUZZLE-IN003A, disconnect the power cords, network cable(s), and also remove any other device/cable that is attached to the server.

Take Anti-Static precautions whenever maintenance is being carried out on the system components. Failure to take anti-static precautions can cause permanent system damage. For more details on anti-static precautions, please refer to **Section 2.1**.

## PUZZLE-IN003A

### 3.10.1 Bypass Configuration in BIOS

The PUZZLE-IN003A supports bypass. To enable/disable bypass function, configure the BIOS menu of the PUZZLE-IN003A as described below.

**Step 1:** Go to **IntelRCSetup** → **South Bridge Chipset Configuration** → **NETWORK Configuration**.

```

Aptio Setup Utility - Copyright (C) 2020 American Megatrends, Inc.
  IntelRCSetup
-----
South Bridge Chipset Configuration
-----
> SATA Configuration
> PCIE IP Configuration
> NETWORK Configuration
-----
Configuration of SATA Controller
-----
-><: Select Screen
↑↓: Select Item
Enter: Select
+/-: Change Opt.
F1: General Help
F2: Previous Values
F3: Optimized Defaults
F4: Save & Exit
ESC: Exit
Version 2.19.1266. Copyright (C) 2020 American Megatrends, Inc.
  
```

**Step 2:** The following sub-menu appears.

```

Aptio Setup Utility - Copyright (C) 2020 American Megatrends, Inc.
  IntelRCSetup
-----
Power_ON ByPass Mode           [Enabled]
Power_OFF ByPass Mode          [Enabled]
-----
Switch all ByPass Mode to Enable/Disable after power on.
-----
-><: Select Screen
↑↓: Select Item
Enter: Select
+/-: Change Opt.
F1: General Help
F2: Previous Values
F3: Optimized Defaults
F4: Save & Exit
ESC: Exit
Version 2.19.1266. Copyright (C) 2020 American Megatrends, Inc.
  
```

**Step 3:** Configure the **Power\_ON ByPass Mode** and the **Power\_OFF ByPass Mode** BIOS options to enable/disable bypass function.

PUZZLE BIOS Setting	Power_ON ByPass Mode		Power_OFF ByPass Mode	
	Disabled	Enabled	Disabled	Enabled
Bypass Function	Disable bypass when system on	Enable bypass when system on	Disable bypass when system off	Enable bypass when system off

**Step 4:** Press **F4** to save and exit the BIOS menu. The PUZZLE-IN003A will reboot with the new settings.

### 3.10.2 Jumper Settings

To configure the jumper settings, please follow the steps below.

**Step 1:** Remove the top cover. See **Section 3.2**.

**Step 2:** Locate the jumper/switch on the embedded motherboard.

**Step 3:** Make the jumper settings in accordance with the settings described and defined in the following sections.

#### 3.10.2.1 Clear CMOS

If the PUZZLE-IN003A fails to boot due to improper BIOS settings, the clear CMOS button clears the CMOS data and resets the system BIOS information. To do this, push the clear CMOS button for a few seconds.

The clear CMOS button location is shown in **Figure 3-12** below.



PUZZLE-IN003A

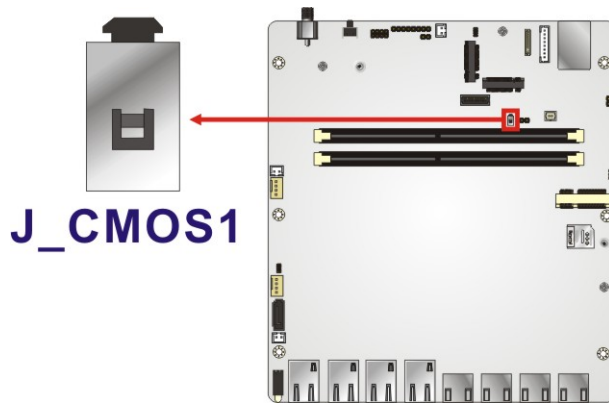

Figure 3-12: Clear CMOS Button Location

3.10.2.2 Flash Descriptor Security Override Jumper

The Flash Descriptor Security Override jumper (J\_FLASH1) allows to enable or disable the ME firmware update.

Setting	Description
Short 1-2	Disabled (default)
Short 2-3	Enabled

Table 3-4: Flash Descriptor Security Override Jumper Settings

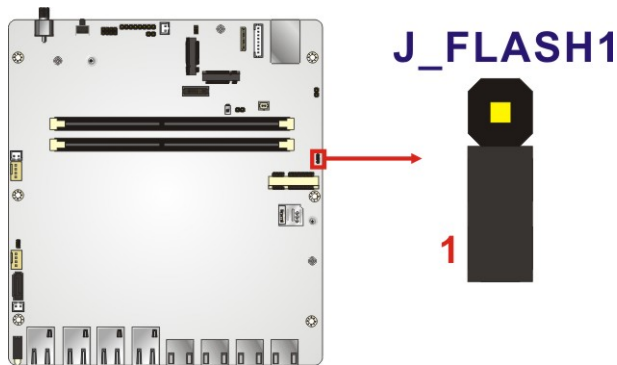

Figure 3-13: Flash Descriptor Security Override Jumper Location

To update the ME firmware, please follow the steps below.

- Step 1:** Before turning on the system power, short the Flash Descriptor Security Override jumper.
- Step 2:** Update the BIOS and ME firmware, and then turn off the system power.
- Step 3:** Remove the metal clip on the Flash Descriptor Security Override jumper.
- Step 4:** Restart the system. The system will reboot 2 ~ 3 times to complete the ME firmware update.

Chapter

4

# BIOS

---

## 4.1 Introduction

The BIOS is programmed onto the BIOS chip. The BIOS setup program allows changes to certain system settings. This chapter outlines the options that can be changed.



### NOTE:

Some of the BIOS options may vary throughout the life cycle of the product and are subject to change without prior notice.

---

### 4.1.1 Starting Setup

The UEFI BIOS is activated when the computer is turned on. The setup program can be activated in one of two ways.

1. Press the **DEL** key as soon as the system is turned on or
2. Press the **DEL** key when the “**Press DEL to enter SETUP**” message appears on the screen.

If the message disappears before the **DEL** key is pressed, restart the computer and try again.

### 4.1.2 Using Setup

Use the arrow keys to highlight items, press **ENTER** to select, use the PageUp and PageDown keys to change entries, press **F1** for help and press **ESC** to quit. Navigation keys are shown in **Table 4-1**.

Key	Function
Up arrow	Move to previous item
Down arrow	Move to next item
Left arrow	Move to the item on the left hand side
Right arrow	Move to the item on the right hand side
+	Increase the numeric value or make changes

## PUZZLE-IN003A

Key	Function
-	Decrease the numeric value or make changes
Esc key	Main Menu – Quit and not save changes into CMOS Status Page Setup Menu and Option Page Setup Menu -- Exit current page and return to Main Menu
F1 key	General help, only for Status Page Setup Menu and Option Page Setup Menu
F2 key	Load previous values
F3 key	Load optimized defaults
F4 key	Save changes and exit BIOS

Table 4-1: BIOS Navigation Keys

### 4.1.3 Getting Help

When **F1** is pressed a small help window describing the appropriate keys to use and the possible selections for the highlighted item appears. To exit the Help Window press **Esc** or the **F1** key again.

### 4.1.4 Unable to Reboot after Configuration Changes

If the computer cannot boot after changes to the system configuration is made, CMOS defaults. Use the clear CMOS button described in **Chapter 3**.

### 4.1.5 BIOS Menu Bar

The **menu bar** on top of the BIOS screen has the following main items:

- Main – Changes the basic system configuration.
- Advanced – Changes the advanced system settings.
- IntelRCSetup – Changes the CPU and chipset settings.
- Security – Sets User and Supervisor Passwords.
- Boot – Changes the system boot configuration.
- Save & Exit – Selects exit options and loads default settings

The following sections completely describe the configuration options found in the menu items at the top of the BIOS screen and listed above.

## 4.2 Main

The **Main** BIOS menu (**BIOS Menu 1**) appears when the **BIOS Setup** program is entered. The **Main** menu gives an overview of the basic system information.

```

Aptio Setup Utility - Copyright (C) 2020 American Megatrends, Inc.
Main  Advanced  IntelRCSetup  Security  Boot  Save & Exit

BIOS Information
BIOS Vendor                American Megatrends
Core Version                5.13
Compliance                 UEFI 2.6; PI 1.4
Project Version             Z625AR10.BIN
Build Date and Time        04/13/2020 15:42:17

iWDD Vendor                iEi
iWDD Version                Z625ER10.bin
Access Level                Administrator

Memory Information
Total Memory                4096 MB (DDR4)

System Date                 [Thu 01/16/2020]
System Time                 [07:10:27]

Set the Date. Use Tab to
switch between Date
elements.
Default Ranges:
Year: 2005-2099
Months: 1-12
Days: dependent on month

-----
-><: Select Screen
↑ ↓: Select Item
Enter: Select
+/-: Change Opt.
F1: General Help
F2: Previous Values
F3: Optimized Defaults
F4: Save & Exit
ESC: Exit

Version 2.19.1266. Copyright (C) 2020 American Megatrends, Inc.
    
```

### BIOS Menu 1: Main

The **Main** menu has two user configurable fields:

➔ **System Date [xx/xx/xx]**

Use the **System Date** option to set the system date. Manually enter the day, month and year.

➔ **System Time [xx:xx:xx]**

Use the **System Time** option to set the system time. Manually enter the hours, minutes and seconds.

## PUZZLE-IN003A

### 4.3 Advanced

Use the **Advanced** menu (**BIOS Menu 2**) to configure the CPU and peripheral devices through the following sub-menus:



#### WARNING!

Setting the wrong values in the sections below may cause the system to malfunction. Make sure that the settings made are compatible with the hardware.

```

Aptio Setup Utility - Copyright (C) 2020 American Megatrends, Inc.
Main   Advanced IntelRCSetup Security Boot Save & Exit
Restore AC Power Loss          [Last State]
mPCIe Function Select          [PCIE]
Select AC power state
when power is re-applied
after a power failure.

> Trusted Computing
> IT8528 Super IO Configuration
> iWDD H/M Monitor
> Serial Port Console Redirection
> NVMe Configuration

-----
-><: Select Screen
↑ ↓: Select Item
Enter: Select
+/-: Change Opt.
F1: General Help
F2: Previous Values
F3: Optimized Defaults
F4: Save & Exit
ESC: Exit

Version 2.19.1266. Copyright (C) 2020 American Megatrends, Inc.
    
```

#### BIOS Menu 2: Advanced

##### → Restore AC Power Loss [Last State]

Use the **Restore AC Power Loss** BIOS option to specify what state the system returns to if there is a sudden loss of power to the system.

- **Power Off**                      The system remains turned off
- **Power On**                        The system turns on
- **Last State**    **DEFAULT**      The system returns to its previous state. If it was on, it turns itself on. If it was off, it remains off.

➔ **mPCIe Function Select [PCIE]**

Use the **mPCIe Function Select** BIOS option to configure PCIe Mini as PCIe or mSATA devices.

- ➔ **PCIE**                                      Configures PCIe Mini devices as PCIe device.
- ➔ **MSATA**                                      Configures PCIe Mini devices as mSATA device.

**4.3.1 Trusted Computing**

Use the **Trusted Computing** menu (**BIOS Menu 3**) to configure settings related to the Trusted Computing Group (TCG) Trusted Platform Module (TPM).

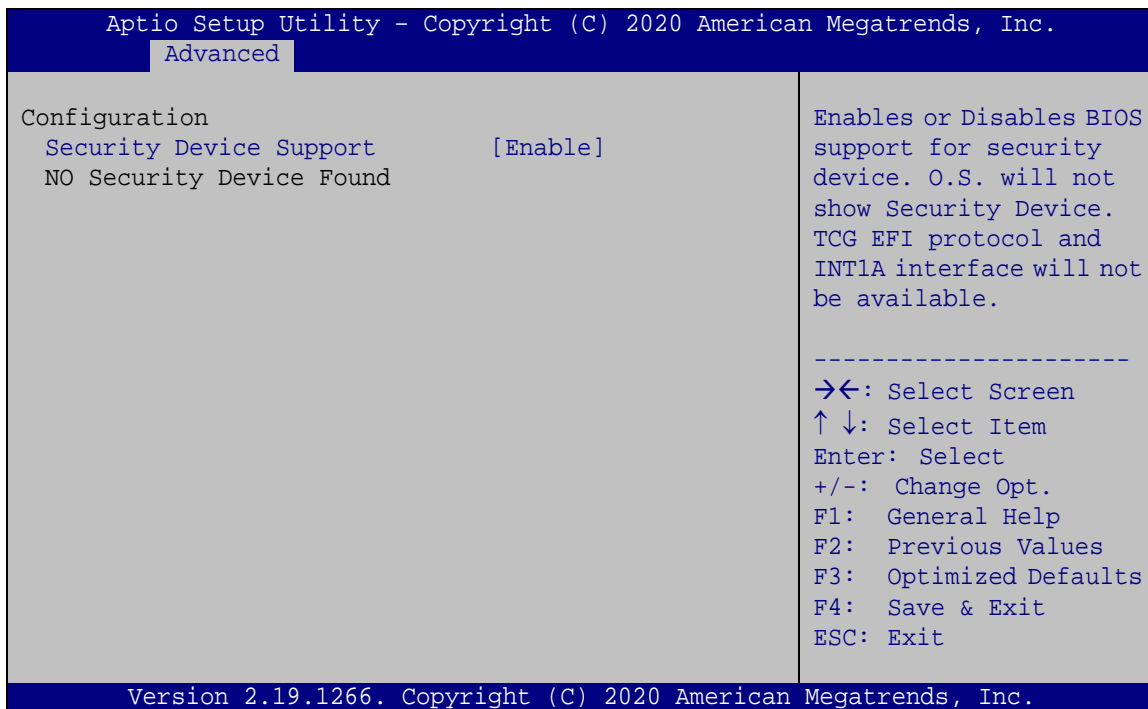

**BIOS Menu 3: Trusted Computing**

➔ **Security Device Support [Enable]**

Use the **Security Device Support** option to configure support for the TPM.

- ➔ **Disable**                                      TPM support is disabled.
- ➔ **Enable**    **DEFAULT**                      TPM support is enabled.



## PUZZLE-IN003A

### 4.3.2 IT8528 Super IO Configuration

Use the **IT8528 Super IO Configuration** menu (**BIOS Menu 4**) to set or change the configurations for the parallel ports and serial ports.

```

Aptio Setup Utility - Copyright (C) 2020 American Megatrends, Inc.
  Advanced
IT8528 Super IO Configuration                               Set Parameters of Serial
                                                           Port 1 (COMA)
Super IO Chip                                             IT8528
> Serial Port 1 Configuration
                                                           -----
                                                           →←: Select Screen
                                                           ↑ ↓: Select Item
                                                           Enter: Select
                                                           +/-: Change Opt.
                                                           F1: General Help
                                                           F2: Previous Values
                                                           F3: Optimized Defaults
                                                           F4: Save & Exit
                                                           ESC: Exit
Version 2.19.1266. Copyright (C) 2020 American Megatrends, Inc.
    
```

**BIOS Menu 4: IT8528 Super IO Configuration**

#### 4.3.2.1 Serial Port 1 Configuration

Use the **Serial Port 1 Configuration** menu (**BIOS Menu 5**) to configure the serial port n.

```

Aptio Setup Utility - Copyright (C) 2020 American Megatrends, Inc.
  Advanced
Serial Port n Configuration                               Enable or Disable Serial
                                                           Port (COM)
Serial Port                                             [Enabled]
Device Settings                                       IO=3F8h; IRQ=10
                                                           -----
                                                           →←: Select Screen
                                                           ↑ ↓: Select Item
                                                           Enter: Select
                                                           +/-: Change Opt.
                                                           F1: General Help
                                                           F2: Previous Values
                                                           F3: Optimized Defaults
                                                           F4: Save & Exit
                                                           ESC: Exit
Version 2.19.1266. Copyright (C) 2020 American Megatrends, Inc.
    
```

**BIOS Menu 5: Serial Port 1 Configuration Menu**

➔ **Serial Port [Enabled]**

Use the **Serial Port** option to enable or disable the serial port.

- ➔ **Disabled**                      Disable the serial port
- ➔ **Enabled**      **DEFAULT**      Enable the serial port

**4.3.3 iWDD H/W Monitor**

The **iWDD H/W Monitor** menu (**BIOS Menu 6**) contains the fan configuration submenu, and displays the system temperature and CPU fan speed.

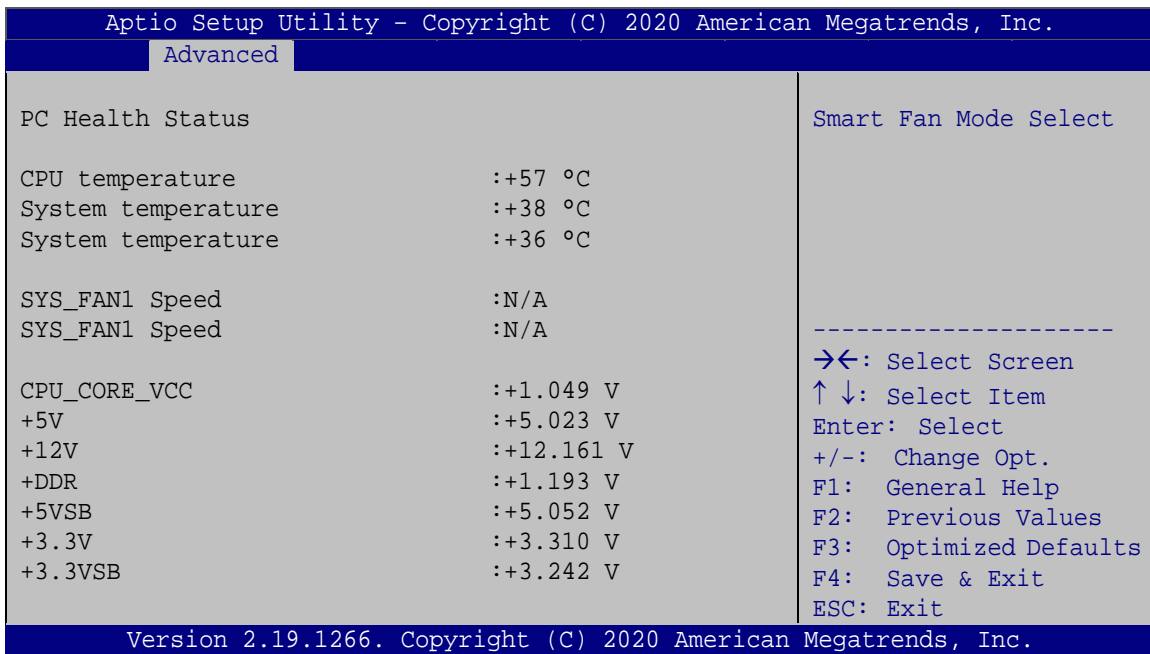

**BIOS Menu 6: iWDD H/W Monitor**

➔ **PC Health Status**

The following system parameters and values are shown. The system parameters that are monitored are:

- Temperatures:
  - CPU Temperature
  - System Temperatures

## PUZZLE-IN003A

- Voltages:
  - CPU\_CORE\_VCC
  - +5V
  - +12V
  - DDR
  - +5VSB
  - +3.3V
  - +3.3VSB

### 4.3.4 Serial Port Console Redirection

The **Serial Port Console Redirection** menu (**BIOS Menu 7**) allows the console redirection options to be configured. Console redirection allows users to maintain a system remotely by re-directing keyboard input and text output through the serial port.

```

Aptio Setup Utility - Copyright (C) 2020 American Megatrends, Inc.
  Advanced
COM1
  Console Redirection          [Enabled]
  > Console Redirection Settings

  Legacy Console Redirection
  > Legacy Console Redirection Settings

  Console Redirection
  Enable or Disable

-----
-><: Select Screen
↑↓: Select Item
Enter: Select
+/-: Change Opt.
F1: General Help
F2: Previous Values
F3: Optimized Defaults
F4: Save & Exit
ESC: Exit

Version 2.19.1266. Copyright (C) 2020 American Megatrends, Inc.

```

**BIOS Menu 7: Serial Port Console Redirection**

**→ Console Redirection [Enabled]**

Use **Console Redirection** option to enable or disable the console redirection function.

- Disabled** Disabled the console redirection function
- Enabled** **DEFAULT** Enabled the console redirection function

The following options are available in the **Console Redirection Settings** submenu when the **Console Redirection** option is enabled.

**→ Terminal Type [ANSI]**

Use the **Terminal Type** option to specify the remote terminal type.

- VT100** The target terminal type is VT100
- VT100+** The target terminal type is VT100+
- VT-UTF8** The target terminal type is VT-UTF8
- ANSI** **DEFAULT** The target terminal type is ANSI

**→ Bits per second [115200]**

Use the **Bits per second** option to specify the serial port transmission speed. The speed must match the other side. Long or noisy lines may require lower speeds.

- 9600** Sets the serial port transmission speed at 9600.
- 19200** Sets the serial port transmission speed at 19200.
- 38400** Sets the serial port transmission speed at 38400.
- 57600** Sets the serial port transmission speed at 57600.
- 115200** **DEFAULT** Sets the serial port transmission speed at 115200.

**→ Data Bits [8]**

Use the **Data Bits** option to specify the number of data bits.

- 7** Sets the data bits at 7.

## PUZZLE-IN003A

→ 8                      **DEFAULT**                      Sets the data bits at 8.

→ **Parity [None]**

Use the **Parity** option to specify the parity bit that can be sent with the data bits for detecting the transmission errors.

→ **None**                      **DEFAULT**                      No parity bit is sent with the data bits.

→ **Even**                      The parity bit is 0 if the number of ones in the data bits is even.

→ **Odd**                      The parity bit is 0 if the number of ones in the data bits is odd.

→ **Mark**                      The parity bit is always 1. This option does not provide error detection.

→ **Space**                      The parity bit is always 0. This option does not provide error detection.

→ **Stop Bits [1]**

Use the **Stop Bits** option to specify the number of stop bits used to indicate the end of a serial data packet. Communication with slow devices may require more than 1 stop bit.

→ 1                      **DEFAULT**                      Sets the number of stop bits at 1.

→ 2                      Sets the number of stop bits at 2.

### 4.3.4.1 Legacy Console Redirection Settings

The **Legacy Console Redirection Settings** menu (**BIOS Menu 8**) allows the legacy console redirection options to be configured.

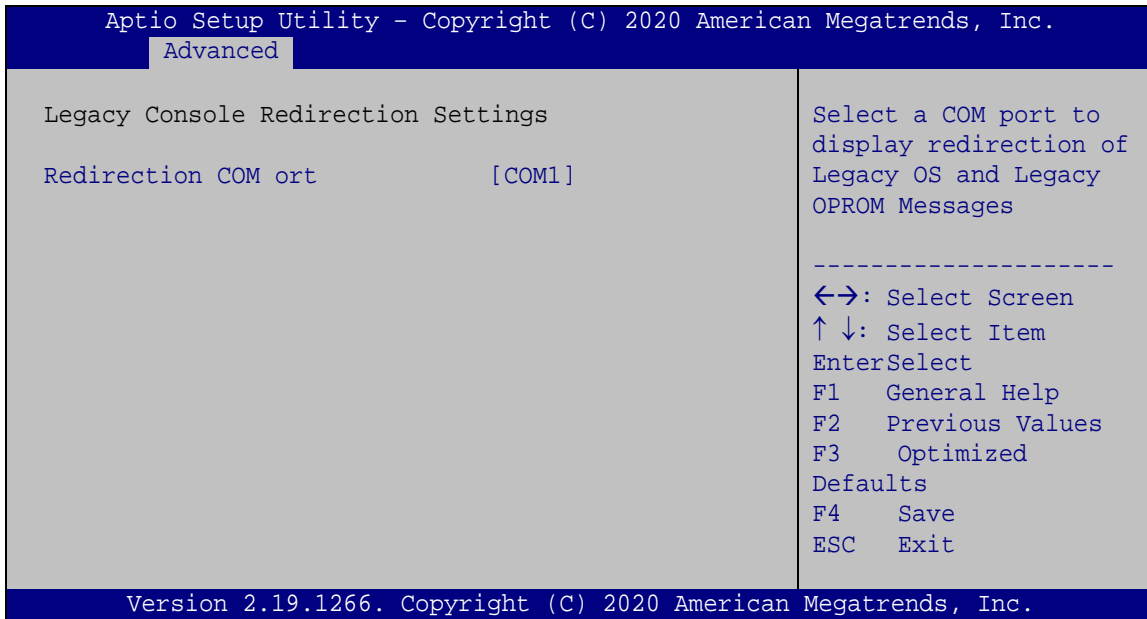

#### BIOS Menu 8: Legacy Console Redirection Settings

##### → Redirection COM Port [COM1]

Use the **Redirection COM Port** option to specify a COM port to display redirection of legacy OS and legacy OPROM messages. The options include:

- COM1            **DEFAULT**

## PUZZLE-IN003A

### 4.3.5 NVMe Configuration

Use the **NVMe Configuration** menu (**BIOS Menu 9**) to change and/or set the configuration of the NVMe devices installed in the system.

```

Aptio Setup Utility - Copyright (C) 2020 American Megatrends, Inc.
  Advanced
NVMe Controller and Drive information
No NVME Device Found
-----
<=>: Select Screen
↑ ↓: Select Item
Enter>Select
F1   General Help
F2   Previous Values
F3   Optimized
Defaults
F4   Save
ESC  Exit
Version 2.19.1266. Copyright (C) 2016 American Megatrends, Inc.
  
```

**BIOS Menu 9: NVMe Configuration**

### 4.4 IntelRCSetup

Use the **IntelRCSetup** menu (**BIOS Menu 10**) to configure the CPU and the chipset through the following sub-menus:

```

Aptio Setup Utility - Copyright (C) 2020 American Megatrends, Inc.
Main   Advanced IntelRCSetup Security Boot Save & Exit
> Processor Configuration
> North Bridge Chipset Configuration
> South Bridge Chipset Configuration
-----
-><: Select Screen
↑ ↓: Select Item
Enter: Select
+/-: Change Opt.
F1: General Help
F2: Previous Values
F3: Optimized Defaults
F4: Save & Exit
ESC: Exit
Version 2.19.1266. Copyright (C) 2020 American Megatrends, Inc.
  
```

**BIOS Menu 10: IntelRCSetup**

### 4.4.1 Processor Configuration

Use the **Processor Configuration** menu (**BIOS Menu 11**) to view detailed CPU specifications or enable the Intel Virtualization Technology.

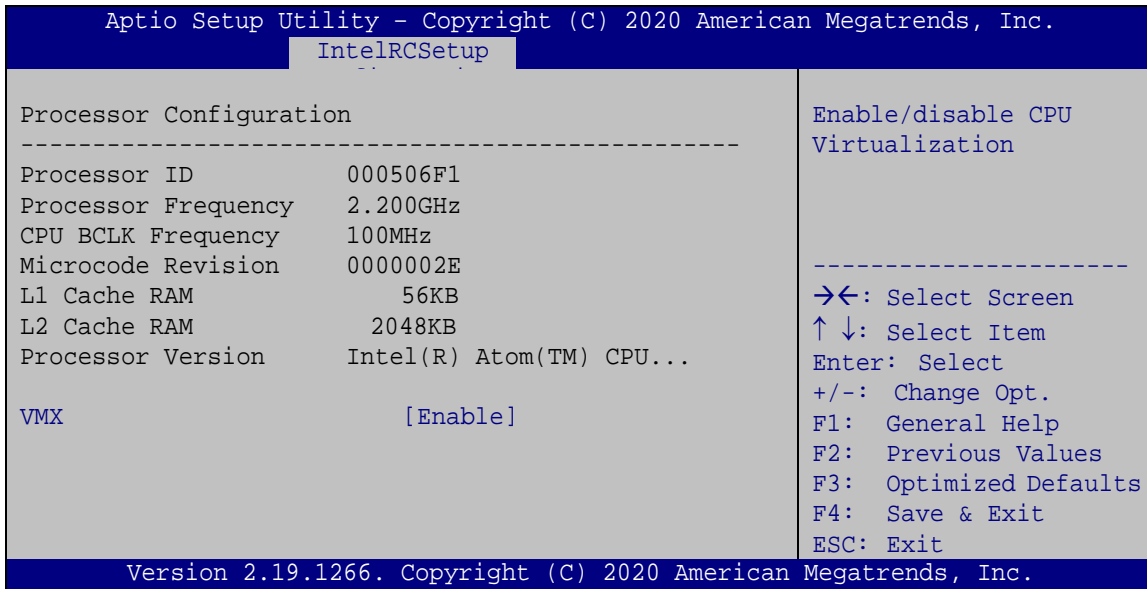

#### BIOS Menu 11: Processor Configuration

##### → VMX [Enable]

Use the **VMX** option to enable or disable virtualization on the system. When combined with third party software, Intel® Virtualization technology allows several OSs to run on the same system at the same time.

- **Disable**                      Disables Intel® Virtualization Technology.
- **Enable**                      **DEFAULT**                      Enables Intel® Virtualization Technology.



## PUZZLE-IN003A

### 4.4.1 North Bridge Chipset Configuration

Use the **North Bridge Chipset Configuration** menu (**BIOS Menu 12**) to view detailed memory specifications or enable/disable Intel VT-d.

```

Aptio Setup Utility - Copyright (C) 2020 American Megatrends, Inc.
IntelRCSetup
-----
North Bridge Chipset Configuration
-----
VT-d                Supported
VT-d                [Enabled]

Memory Information
Total Memory        4096 MB
Memory Frequency    DDR4 - 2133 MHz

-----
-><: Select Screen
↑ ↓: Select Item
Enter: Select
+/-: Change Opt.
F1: General Help
F2: Previous Values
F3: Optimized Defaults
F4: Save & Exit
ESC: Exit

Version 2.19.1266. Copyright (C) 2020 American Megatrends, Inc.

```

#### BIOS Menu 12: North Bridge Chipset Configuration

#### → VT-d [Enabled]

Use the **VT-d** option to enable or disable VT-d support.

- **Disabled**                      Disables VT-d support.
- **Enabled**                      **DEFAULT**      Enables VT-d support.

### 4.4.1 South Bridge Chipset Configuration

Use the **South Bridge Chipset Configuration** menu (**BIOS Menu 13**) to configure SATA devices or PCIe interfaces.

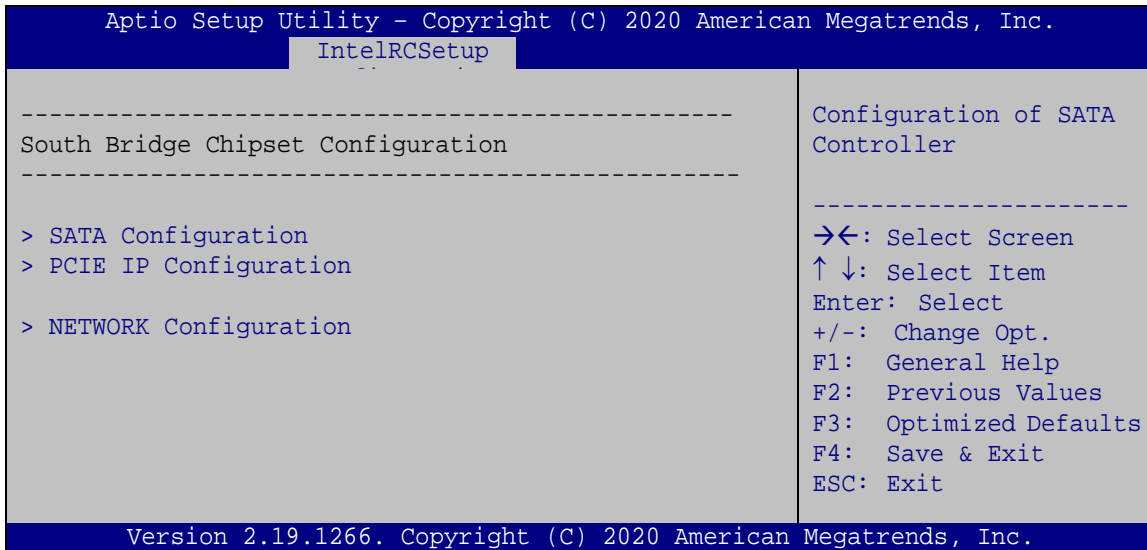

**BIOS Menu 13: South Bridge Chipset Configuration**

#### 4.4.1.1 SATA Configuration

Use the **SATA Configuration** menu (**BIOS Menu 14**) to change and/or set the configuration of the SATA device installed in the system.

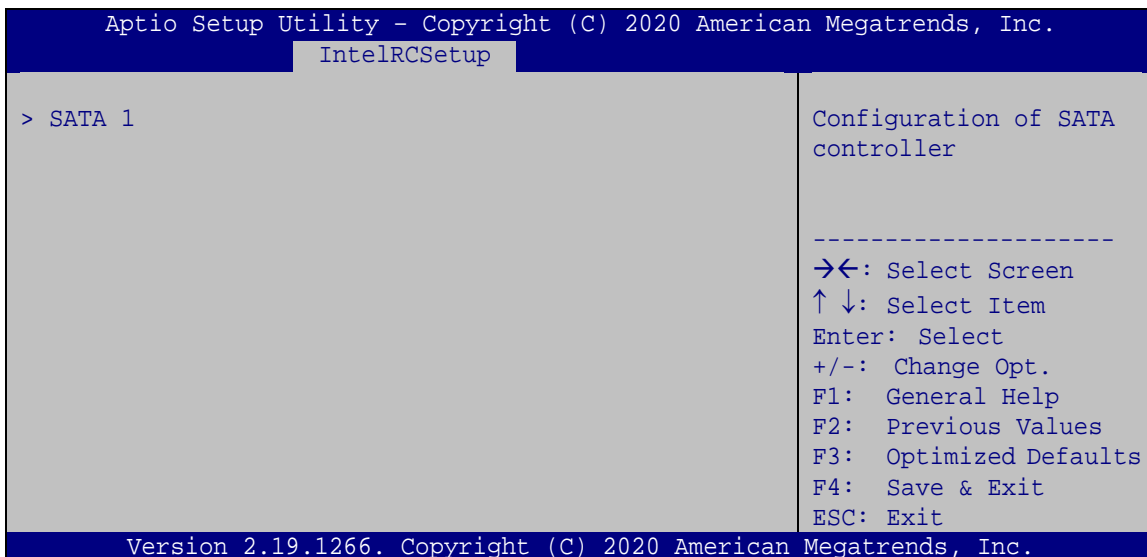

**BIOS Menu 14: SATA Configuration**

## PUZZLE-IN003A

### → Enable/disable port [Enabled]

Use the **Enable/disable port** option to configure the SATA controller.

- **Enabled**      **DEFAULT**      Enables the on-board SATA controller.
- **Disabled**                      Disables the on-board SATA controller.

### → Hot Plug [Disabled]

Use the **Hot Plug** option to enable or disable the hot plug function.

- **Enabled**                      Enables the hot plug function.
- **Disabled**      **DEFAULT**      Disables the hot plug function.

## 4.4.1.2 PCIE IP Configuration

Use the **PCIE IP Configuration** menu (**BIOS Menu 15**) to change and/or set the configuration of the PCIe interfaces.

```

Aptio Setup Utility - Copyright (C) 2020 American Megatrends, Inc.
IntelRCSetup
-----
> M2_CN1
> MINI_PCIE1
> M2_M1

Configuration of PCI Express Root Port

-----
→←: Select Screen
↑ ↓: Select Item
Enter: Select
+/-: Change Opt.
F1: General Help
F2: Previous Values
F3: Optimized Defaults
F4: Save & Exit
ESC: Exit

Version 2.19.1266. Copyright (C) 2020 American Megatrends, Inc.
    
```

**BIOS Menu 15: PCIE IP Configuration**

➔ **Link Speed [Gen3]**

Use the **Link Speed** option to configure the PCIe slot speed.

- Gen1
- Gen2
- Gen3                   **DEFAULT**

### 4.4.1.3 Network Configuration

Use the **Network Configuration** menu (**BIOS Menu 16**) to configure the bypass settings.

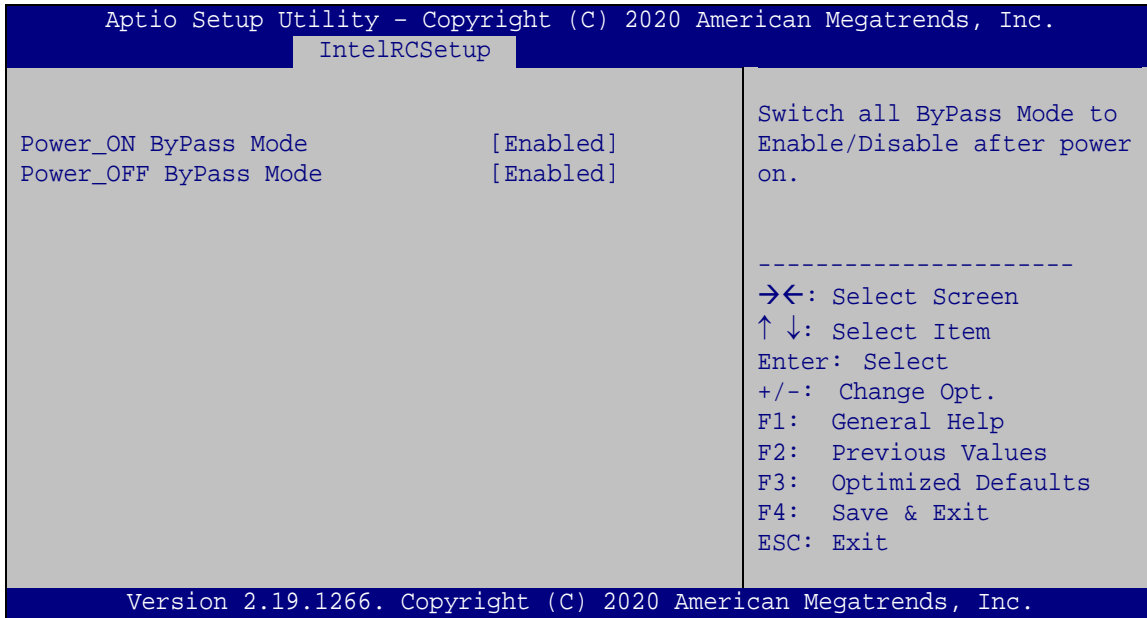

**BIOS Menu 16: Network Configuration**

➔ **Power\_ON ByPass Mode [Enabled]**

Use the **Power\_ON ByPass Mode** option to enable or disable bypass function when the PUZZLE-IN003A is on.

- ➔ **Disabled**                    Bypass is disabled when the system is on.
- ➔ **Enabled**    **DEFAULT**    Bypass is enabled when the system is on.

## PUZZLE-IN003A

### → Power\_OFF ByPass Mode [Enabled]

Use the **Power\_OFF ByPass Mode** option to enable or disable bypass function when the PUZZLE-IN003A is off.

- **Disabled**                      Bypass is disabled when the system is off.
- **Enabled**    **DEFAULT**      Bypass is enabled when the system is off.

## 4.5 Security

Use the **Security** menu (**BIOS Menu 17**) to set system and user passwords.

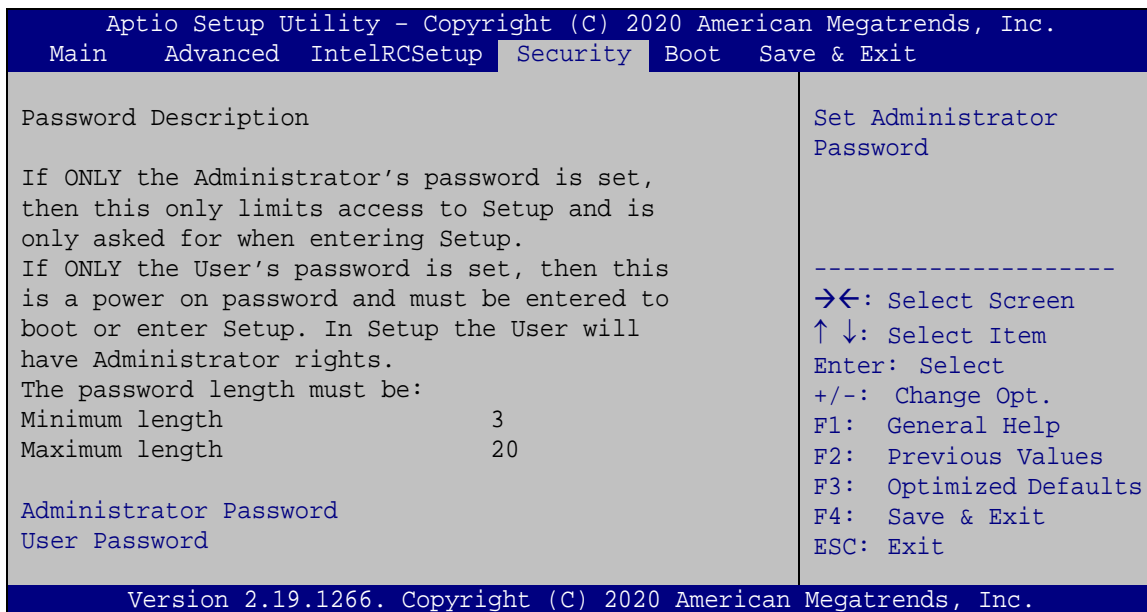

### BIOS Menu 17: Security

#### → Administrator Password

Use the **Administrator Password** to set or change a administrator password.

#### → User Password

Use the **User Password** to set or change a user password.

## 4.6 Boot

Use the **Boot** menu (**BIOS Menu 18**) to configure system boot options.

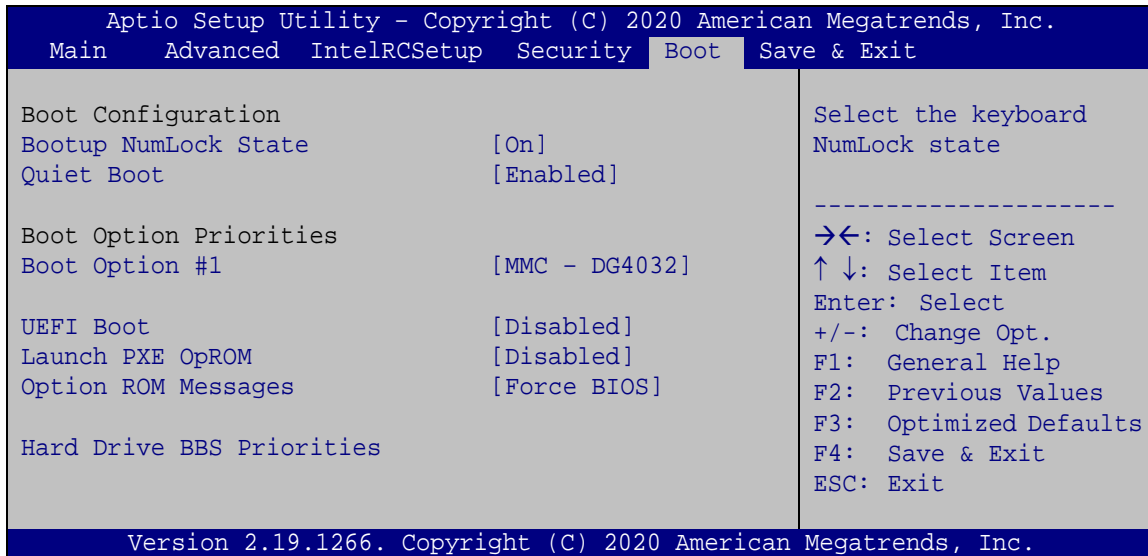

### BIOS Menu 18: Boot

#### → Bootup NumLock State [On]

Use the **Bootup NumLock State** BIOS option to specify if the number lock setting must be modified during boot up.

- **On**                      **DEFAULT**                      Allows the Number Lock on the keyboard to be enabled automatically when the computer system boots up. This allows the immediate use of the 10-key numeric keypad located on the right side of the keyboard. To confirm this, the Number Lock LED light on the keyboard is lit.
  
- **Off**                                      Does not enable the keyboard Number Lock automatically. To use the 10-keys on the keyboard, press the Number Lock key located on the upper left-hand corner of the 10-key pad. The Number Lock LED on the keyboard lights up when the Number Lock is engaged.

## PUZZLE-IN003A

### → Quiet Boot [Enabled]

Use the **Quiet Boot** BIOS option to select the screen display when the system boots.

- **Disabled** Normal POST messages displayed
- **Enabled** **DEFAULT** OEM Logo displayed instead of POST messages

### → UEFI Boot [Disabled]

Use the **UEFI Boot** option to enable or disable to boot from the UEFI devices.

- **Disabled** **DEFAULT** Boot from UEFI devices is disabled.
- **Enabled** Boot from UEFI devices is enabled.

### → Launch PXE OpROM [Disabled]

Use the **Launch PXE OpROM** option to enable or disable boot option for legacy network devices.

- **Disabled** **DEFAULT** Ignore all PXE Option ROMs
- **Enabled** Load PXE Option ROMs.

### → Option ROM Messages [Force BIOS]

Use the **Option ROM Messages** option to set the Option ROM display mode.

- **Force BIOS** **DEFAULT** Sets display mode to force BIOS.
- **Keep Current** Sets display mode to current.

## 4.7 Save & Exit

Use the **Safe & Exit** menu (**BIOS Menu 19**) to load default BIOS values, optimal failsafe values and to save configuration changes.

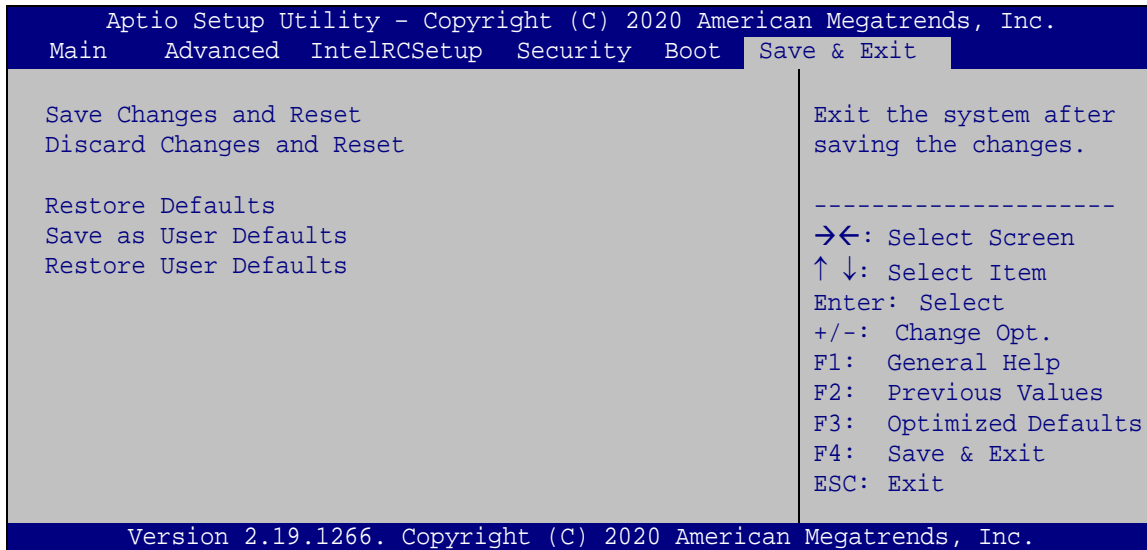

### BIOS Menu 19: Save & Exit

#### → Save Changes and Reset

Use the **Save Changes and Reset** option to save the changes made to the BIOS options and reset the system.

#### → Discard Changes and Reset

Use the **Discard Changes and Reset** option to exit the system without saving the changes made to the BIOS configuration setup program.

#### → Restore Defaults

Use the **Restore Defaults** option to load the optimal default values for each of the parameters on the Setup menus. **F3 key can be used for this operation.**

#### → Save as User Defaults

Use the **Save as User Defaults** option to save the changes done so far as user defaults.

#### → Restore User Defaults

Use the **Restore User Defaults** option to restore the user defaults to all the setup options.



Chapter

**5**

# Interface Connectors

---

## 5.1 Peripheral Interface Connectors

The connector locations of the PUZZLE-IN003A's motherboard are shown below. The connector pinouts for these connectors are listed in the following sections.

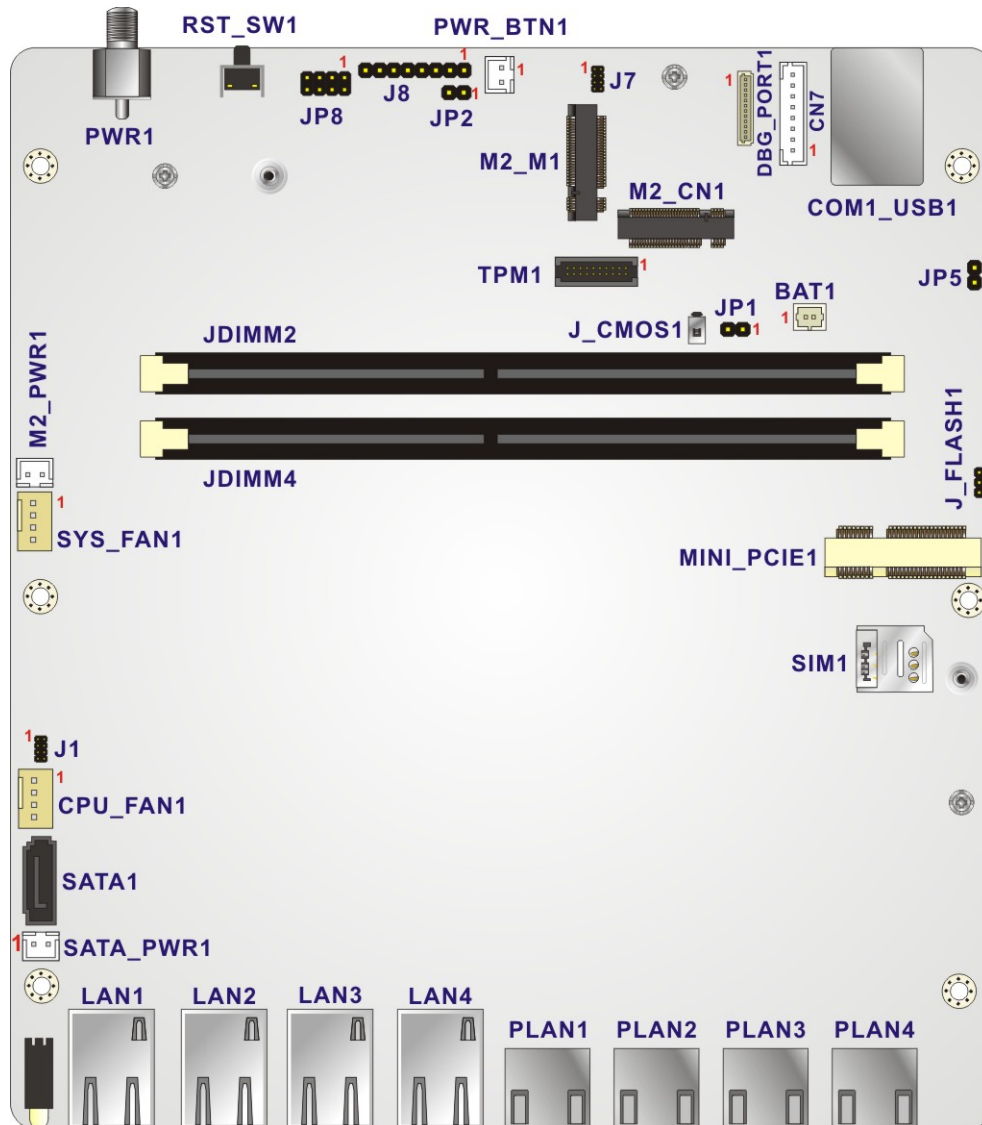

## PUZZLE-IN003A

## 5.2 Internal Peripheral Connectors

Internal peripheral connectors on the motherboard and are only accessible when the motherboard is outside of the chassis. The table below shows a list of the connectors on the motherboard. Pinouts of these connectors can be found in the following sections.

Connector	Type	Label
Battery connector	2-pin wafer	BAT1
CPLD programmer connector	8-pin header	J8
Debug port	12-pin wafer	DBG_PORT1
Fan connectors	4-pin wafer	CPU_FAN1, SYS_FAN1
LCM connector	8-pin wafer	CN7
M.2 A-key slot	M.2 2230 A-key	M2_CN1
M.2 M-key slot	M.2 2280/2260 M-key	M2_M1
M.2 power connector	2-pin wafer	M2_PWR1
Memory slots	DDR4 DIMM slot	JDIMM2, JDIMM4
PCIe Mini slot	Full/Half-size PCIe Mini	MINI_PCIE1
Power button connector	2-pin wafer	PWR_BTN1
SATA 6Gb/s connector	7-pin socket	SATA1
SATA power connector	2-pin wafer	SATA_PWR1
SIM card slot	Micro SIM slot	SIM1
SMBus connector	2-pin header	JP5
SPI flash connector	8-pin header	J1
SPI flash connector (EC)	8-pin header	J7
SVID connector	2-pin header	JP2
TPM connector	20-pin connector	TPM1

### 5.2.1 Battery Connector (BAT1)

PIN NO.	DESCRIPTION
1	Battery+
2	GND

**Table 5-1: Battery Connector (BAT1) Pinouts**

### 5.2.2 CPLD Programmer Connector (J8)

PIN NO.	DESCRIPTION	PIN NO.	DESCRIPTION
1	VCC3	5	NC
2	TDO	6	TMS
3	TDI	7	GND
4	NC	8	TCK

**Table 5-2: CPLD Programmer Connector (J8) Pinouts**

### 5.2.3 Debug Port (DBG\_PORT1)

PIN NO.	DESCRIPTION	PIN NO.	DESCRIPTION
1	NC	7	LPC_AD1
2	+3.3V	8	LPC_ADO
3	GND	9	FRAME
4	SERIRQ	10	RESET
5	LPC_AD3	11	CLK
6	LPC_AD2	12	GND

**Table 5-3: Debug Port (DBG\_PORT1) Pinouts**

## PUZZLE-IN003A

### 5.2.4 Fan Connectors (CPU\_FAN1 & SYS\_FAN1)

PIN NO.	DESCRIPTION
1	GND
2	+12V
3	FANIO
4	PWM

**Table 5-4: Fan Connectors (CPU\_FAN1 & SYS\_FAN1) Pinouts**

### 5.2.5 LCM Connectors (CN7)

PIN NO.	DESCRIPTION
1	+5V
2	PWRBTN_IO
3	LCM_RX_D
4	LCM_TX_D
5	HDD_LED
6	ALERT_LED_IO
7	RESET_IO
8	GND

**Table 5-5: LCM Connectors (CN7) Pinouts**

### 5.2.6 M.2 A-key Slot (M2\_CN1)

PIN NO.	DESCRIPTION	PIN NO.	DESCRIPTION
1	GND	2	+3.3V
3	USB_D+	4	+3.3V
5	USB_D-	6	N/C
7	GND	8	N/C
9	N/C	10	N/C
11	N/C	12	N/C
13	N/C	14	N/C

PIN NO.	DESCRIPTION	PIN NO.	DESCRIPTION
15	N/C	16	N/C
17	N/C	18	GND
19	N/C	20	N/C
21	N/C	22	N/C
23	N/C	24	Notch
25	Notch	26	Notch
27	Notch	28	Notch
29	Notch	30	Notch
31	Notch	32	N/C
33	GND	34	N/C
35	PETPO	36	N/C
37	PETNO	38	N/C
39	GND	40	N/C
41	PERPO	42	N/C
43	PERNO	44	N/C
45	GND	46	N/C
47	REFCLKPO	48	N/C
49	REFCLKNO	50	SUSCLK
51	GND	52	PERSTO#
53	CLKREQ0#	54	N/C
55	PEWAKE0#	56	N/C
57	GND	58	N/C
59	N/C	60	N/C
61	N/C	62	N/C
63	GND	64	N/C
65	N/C	66	N/C
67	N/C	68	N/C
69	GND	70	WAKE
71	N/C	72	+3.3V
73	N/C	74	+3.3V
75	GND		

**Table 5-6: M.2 A-key Slot (M2\_CN1) Pinouts**

**PUZZLE-IN003A**

**5.2.7 M.2 M-key Slot (M2\_M1)**

PIN NO.	DESCRIPTION	PIN NO.	DESCRIPTION
1	GND	2	+3.3V
3	GND	4	+3.3V
5	PCIE_RXN3	6	N/C
7	PCIE_RXP3	8	N/C
9	GND	10	DAS/DSS#
11	PCIE_TXN3	12	+3.3V
13	PCIE_TXP3	14	+3.3V
15	GND	16	+3.3V
17	PCIE_RXN2	18	+3.3V
19	PCIE_RXP2	20	N/C
21	GND	22	N/C
23	PCIE_TXN2	24	N/C
25	PCIE_TXP2	26	N/C
27	GND	28	N/C
29	PCIE_RXN1	30	N/C
31	PCIE_RXP1	32	N/C
33	GND	34	N/C
35	PCIE_TXN1	36	N/C
37	PCIE_TXP1	38	DEVSLP
39	GND	40	N/C
41	PCIE_RXN0	42	N/C
43	PCIE_RXP0	44	N/C
45	GND	46	N/C
47	PCIE_TXN0	48	N/C
49	PCIE_TXP0	50	PERST#
51	GND	52	CLKREQ#
53	REFCLKN	54	PEWAKE
55	REFCLKP	56	N/C
57	GND	58	N/C
59	Notch	60	Notch

PIN NO.	DESCRIPTION	PIN NO.	DESCRIPTION
61	Notch	62	Notch
63	Notch	64	Notch
65	Notch	66	Notch
67	N/C	68	SUSCLK
69	PEDET	70	+3.3V
71	GND	72	+3.3V
73	GND	74	+3.3V
75	GND		

**Table 5-7: M.2 M-key Slot (M2\_M1) Pinouts**

### 5.2.8 M.2 Power Connector (M2\_PWR1)

PIN NO.	DESCRIPTION
1	+5V
2	GND

**Table 5-8: M.2 Power Connector (M2\_PWR1) Pinouts**



## PUZZLE-IN003A

## 5.2.9 PCIe Mini Card Slot (MINI\_PCIE1)

PIN NO.	DESCRIPTION	PIN NO.	DESCRIPTION
1	N/C	2	+3.3V
3	N/C	4	GND
5	N/C	6	1.5V
7	MPCIE_M.2_CLKREQ#	8	SIM_VCC
9	GND	10	SIM_IO
11	CLK_MPCIE_N	12	SIM_CLK
13	CLK_MPCIE_P	14	SIM_RST
15	GND	16	SIM_VPP
17	PLTRST_PCIE_WIFI_N	18	GND
19	N/C	20	+3.3V
21	GND	22	PLTRST_N
23	MPCIE_RXN_C	24	+3.3V
25	MPCIE_RXP_C	26	GND
27	GND	28	1.5V
29	GND	30	SMB_CLK
31	MPCIE_TXN_C	32	SMB_DATA
33	MPCIE_TXP_C	34	GND
35	GND	36	USB_DATA-
37	GND	38	USB_DATA+
39	+3.3V	40	GND
41	+3.3V	42	N/C
43	+3.3V	44	N/C
45	N/C	46	N/C
47	N/C	48	1.5V
49	N/C	50	GND
51	N/C	52	+3.3V

Table 5-9: PCIe Mini Card Slot (MINI\_PCIE1) Pinouts

### 5.2.10 Power Button Connector (PWR\_BTN1)

PIN NO.	DESCRIPTION
1	PWR_BTN
2	GND

**Table 5-10: Power Button Connector (PWR\_BTN1) Pinouts**

### 5.2.11 SATA Connector (SATA1)

PIN NO.	DESCRIPTION	PIN NO.	DESCRIPTION
1	GND	5	RX-
2	TX+	6	RX+
3	TX-	7	GND
4	GND	8	N/C

**Table 5-11: SATA 6Gb/s Connector (SATA1) Pinouts**

### 5.2.12 SATA Power Connector (SATA\_PWR1)

PIN NO.	DESCRIPTION
1	+5V
2	GND

**Table 5-12: SATA Power Connector (SATA\_PWR1) Pinouts**

### 5.2.13 SMBus Connector (JP5)

PIN NO.	DESCRIPTION
1	SMB_HOST_CLK_R
2	SMB_HOST_DATA_R

**Table 5-13: SMBus Connector (JP5) Pinouts**

## PUZZLE-IN003A

### 5.2.14 SPI Flash Connector (J1)

PIN NO.	DESCRIPTION	PIN NO.	DESCRIPTION
1	CS	2	+3.3V
3	MISO	4	N/C
5	WP	6	CLK
7	GND	8	MOSI

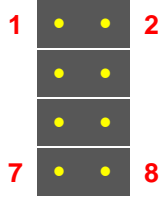

**Table 5-14: SPI Flash Connector (J1) Pinouts**

### 5.2.15 SPI Flash Connector - EC (J7)

PIN NO.	DESCRIPTION	PIN NO.	DESCRIPTION
1	EC_CS	2	+3.3V
3	EC_MISO	4	N/C
5	EC_WP	6	EC_CLK
7	GND	8	EC_MOSI

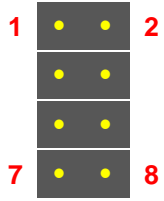

**Table 5-15: SPI Flash Connector (J7) Pinouts**

### 5.2.16 SVID Connector (JP2)

PIN NO.	DESCRIPTION
1	SOC_SVID_CLK
2	SOC_SVID_DATA

**Table 5-16: SVID Connector (JP2) Pinouts**

**5.2.17 TPM Connector (TPM1)**

PIN NO.	DESCRIPTION	PIN NO.	DESCRIPTION
1	N/C	2	TPM_SPI_CS0_N
3	SPI_TPM_GPIO	4	TPM_SPI_CS1_N
5	GND	6	+3V3_SB
7	TPM_SPI_CLK	8	TPM_SPI_DQ2
9	TPM_SPI_DQ3	10	TPM_SPI_MISO
11	TPM_HOLD#	12	TPM_SPI_MOSI
13	SPI_TPM_CS_N_GP12	14	GND
15	TPM_WP#	16	TPM_SERIRQ
17	TPM_PIRQ	18	+3V3_SB
19	PLT_GATED_RST#_X4	20	+3V3_SB

**TPM Connector (TPM1) Pinouts**

Appendix

A

# Regulatory Compliance

---

## DECLARATION OF CONFORMITY



This equipment is in conformity with the following EU directives:

- EMC Directive 2014/30/EU
- Low-Voltage Directive 2014/35/EU
- RoHS II Directive 2015/863/EU

If the user modifies and/or install other devices in the equipment, the CE conformity declaration may no longer apply.

If this equipment has telecommunications functionality, it also complies with the requirements of the R&TTE Directive 1999/5/EC.

---

English

IEI Integration Corp declares that this equipment is in compliance with the essential requirements and other relevant provisions of Directive 1999/5/EC.

---

Български [Bulgarian]

IEI Integration Corp. декларира че този оборудване е в съответствие със съществените изисквания и другите приложими правила на Директива 1999/5/EC.

---

Česky [Czech]

IEI Integration Corp tímto prohlašuje, že tento zařizení je ve shodě se základními požadavky a dalšími příslušnými ustanoveními směrnice 1999/5/ES.

---

Dansk [Danish]

IEI Integration Corp erklærer herved, at følgende udstyr overholder de væsentlige krav og øvrige relevante krav i direktiv 1999/5/EF.

---

Deutsch [German]

IEI Integration Corp, erklärt dieses Gerät entspricht den grundlegenden Anforderungen und den weiteren entsprechenden Vorgaben der Richtlinie 1999/5/EU.

---

Eesti [Estonian]

IEI Integration Corp deklareerib seadme seadme vastavust direktiivi 1999/5/EÜ põhinõuetele ja nimetatud direktiivist tulenevatele teistele asjakohastele sätetele.

---

**PUZZLE-IN003A**

---

**Español [Spanish]**

IEI Integration Corp declara que el equipo cumple con los requisitos esenciales y cualesquiera otras disposiciones aplicables o exigibles de la Directiva 1999/5/CE.

---

**Ελληνική [Greek]**

IEI Integration Corp ΔΗΛΩΝΕΙ ΟΤΙ ΕΞΟΠΛΙΣΜΟΣ ΣΥΜΜΟΡΦΩΝΕΤΑΙ ΠΡΟΣ ΤΙΣ ΟΥΣΙΩΔΕΙΣ ΑΠΑΙΤΗΣΕΙΣ ΚΑΙ ΤΙΣ ΛΟΙΠΕΣ ΣΧΕΤΙΚΕΣ ΔΙΑΤΑΞΕΙΣ ΤΗΣ ΟΔΗΓΙΑΣ 1999/5/EK.

---

**Français [French]**

IEI Integration Corp déclare que l'appareil est conforme aux exigences essentielles et aux autres dispositions pertinentes de la directive 1999/5/CE.

---

**Italiano [Italian]**

IEI Integration Corp dichiara che questo apparecchio è conforme ai requisiti essenziali ed alle altre disposizioni pertinenti stabilite dalla direttiva 1999/5/CE.

---

**Latviski [Latvian]**

IEI Integration Corp deklarē, ka iekārta atbilst būtiskajām prasībām un citiem ar to saistītajiem noteikumiem Direktīvas 1999/5/EK.

---

**Lietuvių [Lithuanian]**

IEI Integration Corp deklaruoja, kad šis įranga atitinka esminius reikalavimus ir kitas 1999/5/EB Direktyvos nuostatas.

---

**Nederlands [Dutch]**

IEI Integration Corp dat het toestel toestel in overeenstemming is met de essentiële eisen en de andere relevante bepalingen van richtlijn 1999/5/EG.

---

**Malti [Maltese]**

IEI Integration Corp jiddikjara li dan prodott jikkonforma mal-ħtiġijiet essenzjali u ma provvedimenti oħrajn relevanti li hemm fid-Direttiva 1999/5/EC.

---

**Magyar [Hungarian]**

IEI Integration Corp nyilatkozom, hogy a berendezés megfelel a vonatkozó alapvető követelményeknek és az 1999/5/EC irányelv egyéb előírásainak.

---

**Polski [Polish]**

IEI Integration Corp oświadcza, że wyrobu jest zgodny z zasadniczymi wymogami oraz pozostałymi stosownymi postanowieniami Dyrektywy 1999/5/EC.

---

**Português [Portuguese]**

IEI Integration Corp declara que este equipamento está conforme com os requisitos essenciais e outras disposições da Directiva 1999/5/CE.

---

---

Româna [Romanian]

IEI Integration Corp declară că acest echipament este în conformitate cu cerințele esențiale și cu celelalte prevederi relevante ale Directivei 1999/5/CE.

---

Slovensko [Slovenian]

IEI Integration Corp izjavlja, da je ta opreme v skladu z bistvenimi zahtevami in ostalimi relevantnimi določili direktive 1999/5/ES.

---

Slovensky [Slovak]

IEI Integration Corp týmto vyhlasuje, že zariadenia spĺňa základné požiadavky a všetky príslušné ustanovenia Smernice 1999/5/ES.

---

Suomi [Finnish]

IEI Integration Corp vakuuttaa täten että laitteet on direktiivin 1999/5/EY oleellisten vaatimusten ja sitä koskevien direktiivin muiden ehtojen mukainen.

---

Svenska [Swedish]

IEI Integration Corp förklarar att denna utrustningstyp står i överensstämmelse med de väsentliga egenskapskrav och övriga relevanta bestämmelser som framgår av direktiv 1999/5/EG.

---



**PUZZLE-IN003A****FCC WARNING**

This equipment complies with Part 15 of the FCC Rules. Operation is subject to the following two conditions:

- This device may not cause harmful interference, and
- This device must accept any interference received, including interference that may cause undesired operation.

This equipment has been tested and found to comply with the limits for a Class A digital device, pursuant to part 15 of the FCC Rules. These limits are designed to provide reasonable protection against harmful interference when the equipment is operated in a commercial environment. This equipment generates, uses, and can radiate radio frequency energy and, if not installed and used in accordance with the instruction manual, may cause harmful interference to radio communications. Operation of this equipment in a residential area is likely to cause harmful interference in which case the user will be required to correct the interference at his own expense.

**ROHS STATEMENT**

The label on the product indicates this product conforms to European (EU) Restriction of Hazardous Substances (RoHS) that set maximum concentration limits on hazardous materials used in electrical and electronic equipment.

**CHINA ROHS**

The label on the product indicates the estimated “Environmentally Friendly Use Period” (EFUP). This is an estimate of the number of years that these substances would “not leak out or undergo abrupt change.” This product may contain replaceable sub-assemblies/components which have a shorter EFUP such as batteries and lamps. These components will be separately marked.

Appendix

**B**

# Safety Precautions

---

## PUZZLE-IN003A

### B.1 Safety Precautions

---



#### WARNING:

The precautions outlined in this appendix should be strictly followed. Failure to follow these precautions may result in permanent damage to the PUZZLE-IN003A.

---

Please follow the safety precautions outlined in the sections that follow:

#### B.1.1 General Safety Precautions

Please ensure the following safety precautions are adhered to at all times.

- ***Make sure the power is turned off and the power cord is disconnected*** when moving, installing or modifying the system.
- ***Do not apply voltage levels that exceed the specified voltage range.*** Doing so may cause fire and/or an electrical shock.
- ***Electric shocks can occur*** if opened while still powered on.
- ***Do not drop or insert any objects*** into the ventilation openings.
- ***If considerable amounts of dust, water, or fluids enter the system***, turn off the power supply immediately, unplug the power cord, and contact the system vendor.
- **DO NOT:**
  - Drop the system against a hard surface.
  - In a site where the ambient temperature exceeds the rated temperature

#### B.1.2 Anti-static Precautions

---



#### WARNING:

Failure to take ESD precautions during the installation of the PUZZLE-IN003A may result in permanent damage to the PUZZLE-IN003A and severe injury to the user.

---

Electrostatic discharge (ESD) can cause serious damage to electronic components, including the PUZZLE-IN003A. Dry climates are especially susceptible to ESD. It is therefore critical that whenever the PUZZLE-IN003A is opened and any of the electrical components are handled, the following anti-static precautions are strictly adhered to.

- **Wear an anti-static wristband:** Wearing a simple anti-static wristband can help to prevent ESD from damaging any electrical component.
- **Self-grounding:** Before handling any electrical component, touch any grounded conducting material. During the time the electrical component is handled, frequently touch any conducting materials that are connected to the ground.
- **Use an anti-static pad:** When configuring or working with an electrical component, place it on an anti-static pad. This reduces the possibility of ESD damage.
- **Only handle the edges of the electrical component:** When handling the electrical component, hold the electrical component by its edges.

### B.1.3 Product Disposal



#### CAUTION:

Risk of explosion if the battery is replaced by an incorrect type;

Dispose of used batteries according to instructions and local regulations.

---

- Outside the European Union - If you wish to dispose of used electrical and electronic products outside the European Union, please contact your local authority so as to comply with the correct disposal method.
- Within the European Union:

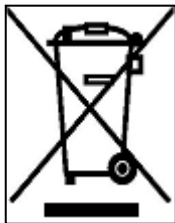

EU-wide legislation, as implemented in each Member State, requires that waste electrical and electronic products carrying the mark (left) must be disposed of separately from normal household waste. This includes monitors and electrical accessories, such as signal cables or power cords. When you need to dispose of your display products, please follow

## PUZZLE-IN003A

the guidance of your local authority, or ask the shop where you purchased the product. The mark on electrical and electronic products only applies to the current European Union Member States.

Please follow the national guidelines for electrical and electronic product disposal.

## B.2 Maintenance and Cleaning Precautions

When maintaining or cleaning the PUZZLE-IN003A, please follow the guidelines below.

### B.2.1 Maintenance and Cleaning

Prior to cleaning any part or component of the PUZZLE-IN003A, please read the details below.

- The interior of the PUZZLE-IN003A does not require cleaning. Keep fluids away from the PUZZLE-IN003A interior.
- Be cautious of all small removable components when vacuuming the PUZZLE-IN003A.
- Turn the PUZZLE-IN003A off before cleaning the PUZZLE-IN003A.
- Never drop any objects or liquids through the openings of the PUZZLE-IN003A.
- Be cautious of any possible allergic reactions to solvents or chemicals used when cleaning the PUZZLE-IN003A.
- Avoid eating, drinking and smoking within vicinity of the PUZZLE-IN003A.

### B.2.2 Cleaning Tools

Some components in the PUZZLE-IN003A may only be cleaned using a product specifically designed for the purpose. In such case, the product will be explicitly mentioned in the cleaning tips. Below is a list of items to use when cleaning the PUZZLE-IN003A.

- **Cloth** – Although paper towels or tissues can be used, a soft, clean piece of cloth is recommended when cleaning the PUZZLE-IN003A.
- **Water or rubbing alcohol** – A cloth moistened with water or rubbing alcohol can be used to clean the PUZZLE-IN003A.
- **Using solvents** – The use of solvents is not recommended when cleaning the PUZZLE-IN003A as they may damage the plastic parts.

- **Vacuum cleaner** – Using a vacuum specifically designed for computers is one of the best methods of cleaning the PUZZLE-IN003A. Dust and dirt can restrict the airflow in the PUZZLE-IN003A and cause its circuitry to corrode.
- **Swabs** - Swabs moistened with rubbing alcohol or water are excellent tools for wiping hard to reach areas. Whenever possible, it is best to use lint free swabs such as foam swabs for cleaning.

Appendix

C

# Hazardous Materials Disclosure

---

### C.1 RoHS II Directive (2015/863/EU)

The details provided in this appendix are to ensure that the product is compliant with the RoHS II Directive (2015/863/EU). The table below acknowledges the presences of small quantities of certain substances in the product, and is applicable to RoHS II Directive (2015/863/EU).

Please refer to the following table.

Part Name	Toxic or Hazardous Substances and Elements									
	Lead (Pb)	Mercury (Hg)	Cadmium (Cd)	Hexavalent Chromium (CR(VI))	Polybrominated Biphenyls (PBB)	Polybrominated Diphenyl Ethers (PBDE)	Bis(2-ethylhexyl) phthalate (DEHP)	Butyl benzyl phthalate (BBP)	Dibutyl phthalate (DBP)	Diisobutyl phthalate (DIBP)
Housing	O	O	O	O	O	O	O	O	O	O
Display	O	O	O	O	O	O	O	O	O	O
Printed Circuit Board	O	O	O	O	O	O	O	O	O	O
Metal Fasteners	O	O	O	O	O	O	O	O	O	O
Cable Assembly	O	O	O	O	O	O	O	O	O	O
Fan Assembly	O	O	O	O	O	O	O	O	O	O
Power Supply Assemblies	O	O	O	O	O	O	O	O	O	O
Battery	O	O	O	O	O	O	O	O	O	O

O: This toxic or hazardous substance is contained in all of the homogeneous materials for the part is below the limit requirement in Directive (EU) 2015/863.

X: This toxic or hazardous substance is contained in at least one of the homogeneous materials for this part is above the limit requirement in Directive (EU) 2015/863.



## PUZZLE-IN003A

### C.2 China RoHS

此附件旨在确保本产品符合中国 RoHS 标准。以下表格标示此产品中某有毒物质的含量符合中国 RoHS 标准规定的限量要求。

本产品上会附有“环境友好使用期限”的标签，此期限是估算这些物质“不会有泄漏或突变”的年限。本产品可能包含有较短的环境友好使用期限的可替换元件，像是电池或灯管，这些元件将会单独标示出来。

部件名称	有毒有害物质或元素					
	铅 (Pb)	汞 (Hg)	镉 (Cd)	六价铬 (CR(VI))	多溴联苯 (PBB)	多溴二苯醚 (PBDE)
壳体	○	○	○	○	○	○
显示	○	○	○	○	○	○
印刷电路板	○	○	○	○	○	○
金属螺帽	○	○	○	○	○	○
电缆组装	○	○	○	○	○	○
风扇组装	○	○	○	○	○	○
电力供应组装	○	○	○	○	○	○
电池	○	○	○	○	○	○

○: 表示该有毒有害物质在该部件所有物质材料中的含量均在 SJ/T11364-2014 與 GB/T26572-2011 标准规定的限量要求以下。

X: 表示该有毒有害物质至少在该部件的某一均质材料中的含量超出 SJ/T11364-2014 與 GB/T26572-2011 标准规定的限量要求。