



MODEL:  
**IKARPC-07A-BT**

**7" In-Vehicle Panel PC with Touchscreen,  
Intel® Atom® Processor E3826, OBD-II, GPS, HDMI,  
USB 2.0/3.0, RS-232, RoHS Compliant, IP 54 Front Panel**

## **User Manual**

# Revision

---

Date	Version	Changes
December 1, 2017	1.11	Modified product description on the cover page. Added connector pinouts of optional OBD-II cable Modified Section 4.2: Mobile AP
August 11, 2016	1.10	Updated Section 1.3: Front Panel Updated Section 4.2: Mobile AP
November 27, 2015	1.01	Updated Table 6-1: Peripheral Interface Connectors
June 18, 2015	1.00	Initial release

# Copyright

---

## **COPYRIGHT NOTICE**

The information in this document is subject to change without prior notice in order to improve reliability, design and function and does not represent a commitment on the part of the manufacturer.

In no event will the manufacturer be liable for direct, indirect, special, incidental, or consequential damages arising out of the use or inability to use the product or documentation, even if advised of the possibility of such damages.

This document contains proprietary information protected by copyright. All rights are reserved. No part of this manual may be reproduced by any mechanical, electronic, or other means in any form without prior written permission of the manufacturer.

## **TRADEMARKS**

All registered trademarks and product names mentioned herein are used for identification purposes only and may be trademarks and/or registered trademarks of their respective owners.

# Manual Conventions

---



## **WARNING**

Warnings appear where overlooked details may cause damage to the equipment or result in personal injury. Warnings should be taken seriously.



## **CAUTION**

Cautionary messages should be heeded to help reduce the chance of losing data or damaging the product.



## **NOTE**

These messages inform the reader of essential but non-critical information. These messages should be read carefully as any directions or instructions contained therein can help avoid making mistakes.



## **HOT SURFACE**

This symbol indicates a hot surface that should not be touched without taking care.

# Table of Contents

<b>1 INTRODUCTION.....</b>	<b>1</b>
1.1 OVERVIEW.....	2
1.2 FEATURES.....	2
1.3 FRONT PANEL.....	3
1.3.1 LED Indicators.....	4
1.4 REAR PANEL.....	5
1.5 BOTTOM PANEL.....	6
1.6 SIDE PANELS .....	6
1.7 TOP PANEL .....	7
1.8 DIMENSIONS.....	7
1.9 SYSTEM SPECIFICATIONS.....	8
<b>2 UNPACKING .....</b>	<b>10</b>
2.1 PACKING LIST.....	11
2.2 OPTIONAL ITEMS .....	12
<b>3 INSTALLATION .....</b>	<b>15</b>
3.1 ANTI-STATIC PRECAUTIONS .....	16
3.2 INSTALLATION PRECAUTIONS .....	16
3.3 MICROSD CARD INSTALLATION.....	17
3.4 SIM CARD INSTALLATION (OPTIONAL) .....	18
3.5 MOUNTING THE SYSTEM .....	20
3.6 EXTERNAL I/O CONNECTORS .....	21
3.6.1 I/O Connector 1 (20-pin).....	21
3.6.2 I/O Connector 2 (24-pin).....	23
3.6.3 HDMI Connector .....	24
3.6.4 Power Input Connection .....	25
3.6.5 USB Connector .....	26
3.7 POWER-ON PROCEDURE.....	27
3.7.1 Power State .....	27
3.8 SYSTEM MAINTENANCE.....	28



<b>4 SOFTWARE DRIVERS .....</b>	<b>29</b>
4.1 DRIVERS.....	30
4.2 MOBILE AP .....	31
4.2.1 Installation .....	31
4.2.2 Usage .....	32
<b>5 BIOS .....</b>	<b>33</b>
5.1 INTRODUCTION.....	34
5.1.1 Starting Setup.....	34
5.1.2 Using Setup .....	34
5.1.3 Getting Help.....	35
5.1.4 BIOS Menu Bar.....	35
5.2 MAIN.....	36
5.3 ADVANCED .....	38
5.3.1 ACPI Settings .....	39
5.3.2 Super IO Configuration .....	40
5.3.2.1 Serial Port 1 Configuration .....	40
5.3.3 Hardware Monitor .....	42
5.3.4 Power Management .....	43
5.3.5 SMS/RTC Wake Settings.....	44
5.3.6 Serial Port Console Redirection .....	45
5.3.7 CPU Configuration.....	48
5.3.8 IDE Configuration .....	50
5.3.9 USB Configuration.....	51
5.4 CHIPSET .....	52
5.4.1 North Bridge Configuration.....	53
5.4.1.1 Intel IGD Configuration.....	54
5.4.2 South Bridge Configuration.....	55
5.5 SECURITY.....	57
5.6 BOOT.....	58
5.7 SAVE & EXIT .....	60
<b>6 INTERFACE CONNECTORS .....</b>	<b>62</b>
6.1 PERIPHERAL INTERFACE CONNECTORS.....	63
6.2 INTERNAL PERIPHERAL CONNECTORS .....	64

## **IKARPC-07A-BT In-vehicle Panel PC**

6.2.1 Battery Connector (BT1).....	65
6.2.2 Camera Connector (WEB1).....	65
6.2.3 Clear CMOS Connector (C_CMOS1) .....	65
6.2.4 LED Connector (JLED1).....	65
6.2.5 LVDS Connector (LVDS1).....	66
6.2.6 Microphone Connector (JMIC1) .....	67
6.2.7 mSATA Module Socket (SATA1).....	67
6.2.8 PCIe Mini Socket for 3.75G Module (MINI_PCIE1) .....	68
6.2.9 PCIe Mini Socket for Wireless Module (MINI_PCIE2).....	69
6.2.10 Programming Connector (JMCU1).....	70
6.2.11 Programming Connector (JOB1).....	70
6.2.12 Speaker Connector (JSP1).....	70
6.2.13 SPI Flash Connector (JSP11).....	71
6.2.14 Touch Panel Connector (TOUCH1).....	71
6.3 EXTERNAL PERIPHERAL CONNECTORS .....	72
<b>A REGULATORY COMPLIANCE .....</b>	<b>73</b>
<b>B SAFETY PRECAUTIONS .....</b>	<b>78</b>
B.1 SAFETY PRECAUTIONS.....	79
<i>B.1.1 General Safety Precautions</i> .....	79
<i>B.1.2 Anti-static Precautions</i> .....	80
<i>B.1.3 Product Disposal</i> .....	81
B.2 MAINTENANCE AND CLEANING PRECAUTIONS .....	82
<i>B.2.1 Maintenance and Cleaning</i> .....	82
<i>B.2.2 Cleaning Tools</i> .....	82
<b>C WATCHDOG TIMER .....</b>	<b>84</b>
<b>D HAZARDOUS MATERIALS DISCLOSURE .....</b>	<b>87</b>

# List of Figures

---

Figure 1-1: IKARPC-07A-BT Panel PC.....	2
Figure 1-2: Front View.....	3
Figure 1-3: LED Indicators.....	4
Figure 1-4: Rear Panel.....	5
Figure 1-5: Bottom View.....	6
Figure 1-6: Side Panels.....	6
Figure 1-7: Top Panel.....	7
Figure 1-8: Dimensions (unit: mm).....	7
Figure 3-1: microSD Card Slot Access Panel Retention Screw.....	17
Figure 3-2: Install microSD Card.....	17
Figure 3-3: SIM Card Slot Access Panel Retention Screw.....	18
Figure 3-4: SIM Card Slot Locations.....	18
Figure 3-5: VESA Mount Retention Screw Holes.....	20
Figure 3-6: IO 1 Connector Pinout Locations.....	21
Figure 3-7: OBD-II Cable.....	22
Figure 3-8: OBD-II Connector Pinouts.....	22
Figure 3-9: IO 2 Connector Pinout Locations.....	23
Figure 3-10: HDMI Connector.....	24
Figure 3-11: Power Input Connector.....	25
Figure 3-12: ACC Power Cable.....	25
Figure 3-13: Optional Cigarette Lighter Cable.....	26
Figure 3-14: USB Connector.....	26
Figure 4-1: Mobile AP-Connection.....	32
Figure 6-1: Main Board Layout Diagram (Front Side).....	63
Figure 6-2: Main Board Layout Diagram (Solder Side).....	63



# List of Tables

Table 1-1: LED Indicators .....	4
Table 1-2: Technical Specifications.....	9
Table 2-1: Packing List.....	12
Table 2-2: Optional Items .....	14
Table 3-1: IO 1 Connector Pinouts.....	21
Table 3-2: IO 2 Connector Pinouts.....	23
Table 3-3: HDMI Connector Pinouts .....	24
Table 3-4: Power Input Connector Pinouts .....	25
Table 3-5: Power State and Ignition System.....	27
Table 5-1: BIOS Navigation Keys .....	35
Table 6-1: Peripheral Interface Connectors .....	64
Table 6-2: Battery Connector (BT1) Pinouts.....	65
Table 6-3: Camera Connector (WEB1) Pinouts .....	65
Table 6-4: Clear CMOS Connector (C_CMOS1) Pinouts.....	65
Table 6-5: LED Connector (JLED1) Pinouts.....	66
Table 6-6: LVDS Connector (LVDS1) Pinouts.....	66
Table 6-7: Microphone Connector (JMIC1) Pinouts .....	67
Table 6-8: mSATA Module Socket (SATA1) Pinouts.....	68
Table 6-9: PCIe Mini Socket for 3.75G Module (MINI_PCIE1) Pinouts.....	69
Table 6-10: PCIe Mini Socket for Wireless Module (MINI_PCIE2) Pinouts.....	70
Table 6-11: Programming Connector (JMCU1) Pinouts .....	70
Table 6-12: Programming Connector (JOB1) Pinouts.....	70
Table 6-13: Speaker Connector (JSP1) Pinouts .....	70
Table 6-14: SPI Flash Connector (JSPI1) Pinouts .....	71
Table 6-15: Touch Panel Connector (TOUCH1) Pinouts.....	71
Table 6-16: Peripheral Interface Connectors .....	72



Chapter

1

# Introduction

---

## 1.1 Overview



**Figure 1-1: IKARPC-07A-BT Panel PC**

The IKARPC-07A-BT is a 7" panel PC designed for in-car use. At the heart of the system is the Intel® Atom® processor E3826, offering low power in a powerful package.

The system also offers a multimedia experience with a built-in 2-megapixel camera, HDMI port and speaker. The OBD-II connection and GPS functionality make the IKARPC-07A-BT an ideal system for in-vehicle applications.

Other peripherals include one USB 2.0 port, one USB 3.0 port, and two I/O connectors which support RS-232, OBD-II/J1939, digital I/O, USB and audio input/output. Wireless networking capabilities include Bluetooth 2.0 and 802.11b/g/n.

## 1.2 Features

The IKARPC-07A-BT features the following:

- Projected capacitive touchscreen
- Intel® Atom® processor E3826 (dual-core, 1.46 GHz, 7 W TDP)
- On-board 2.0 GB SDRAM memory
- Support OBD-II/J1939, RS-232 and digital I/O
- GPS functionality with external antenna connector
- 2-megapixel front-facing camera and speaker
- One HDMI connector

## IKARPC-07A-BT In-vehicle Panel PC

- Optional 802.11b/g/n wireless connection
- Optional 3.75G connectivity with dual SIM and an external antenna
- Optional Bluetooth 2.0
- IP 54 compliant front panel
- RoHS compliance

### 1.3 Front Panel

The front of the IKARPC-07A-BT is a flat panel screen with a plastic frame. The components on the front panel are listed below:

- 2-megapixel camera
- Ambient light sensor
- LED indicators (see **Section 1.3.1**)

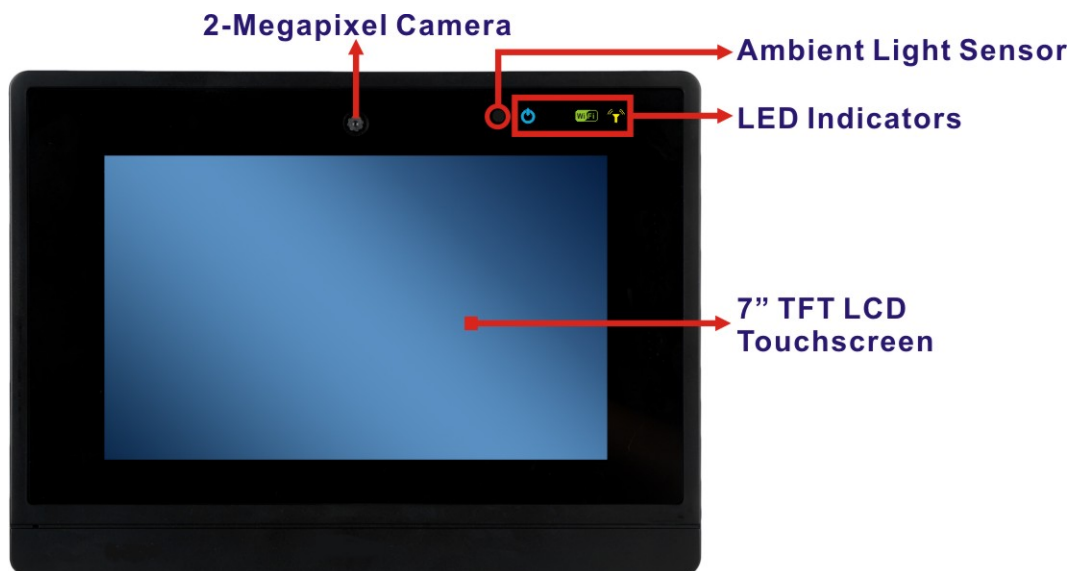

Figure 1-2: Front View



#### NOTE:

The automatic screen-dimming function is controlled by the BIOS option. To enable or disable the function, please refer to **Section 5.4.1.1** (LVDS AUTO DIMMING Control option).



### 1.3.1 LED Indicators

The LED indicators on the front panel show the status of power, Wi-Fi and 3.75G connection.

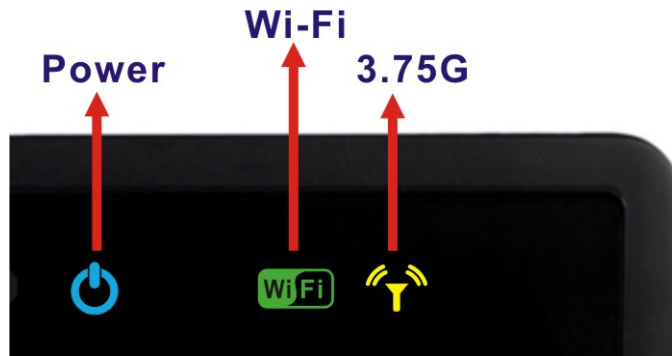

**Figure 1-3: LED Indicators**

<b>Power LED</b>	Red	The system is off with power connected
	Blue	The system is turned on
	Blinking	At regular intervals: low voltage warning (configured by BIOS option: Section 5.3.4) At irregular intervals (long-short-short): GPS antenna is not connected.
<b>Wi-Fi LED</b>	Off	Wi-Fi is not connected
	Green	Wi-Fi is connected
<b>3.75G LED</b>	Yellow	SIM1 is being used for 3.75G connection
	Red	SIM2 is being used for 3.75G connection

**Table 1-1: LED Indicators**

## IKARPC-07A-BT In-vehicle Panel PC

### 1.4 Rear Panel

The rear panel has VESA mounting screw holes and an access panel for microSD card and SIM card. The following I/O connectors can also be found on the rear panel.

- 1 x 9 V~ 30 V DC input connector
- 20-pin connector:
  - 1 x GbE LAN
  - 1 x OBD-II/J1939
  - 1 x USB
- 24-pin connector:
  - 1 x Audio line-out (R+L)
  - 1 x Audio line-in
  - 1 x RS-232
  - 2-bit digital input
  - 2-bit digital output
- 1 x HDMI connector
- 1 x GPS antenna connector
- 1 x 3.75G antenna connector (optional)

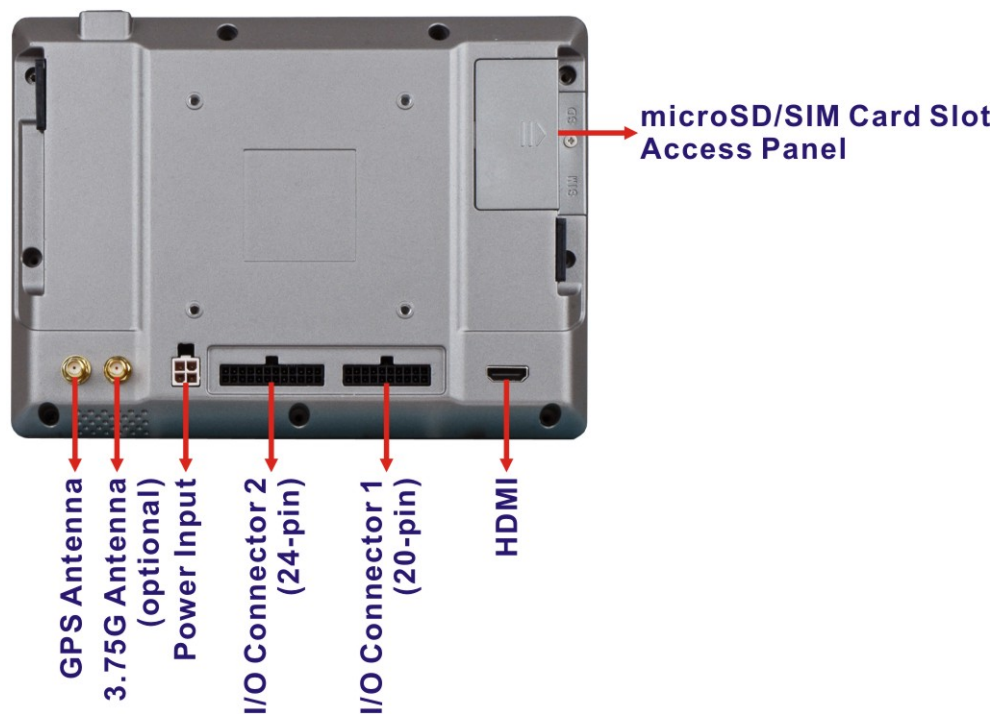

Figure 1-4: Rear Panel

### 1.5 Bottom Panel

The bottom panel has a 2 W speaker.



Figure 1-5: Bottom View

### 1.6 Side Panels

The right side panel has one USB 3.0 port and the left side panel has one USB 2.0 port.



Figure 1-6: Side Panels

## IKARPC-07A-BT In-vehicle Panel PC

### 1.7 Top Panel

The top panel has a power button. Press the power button for 4~6 seconds to power on the system.



Figure 1-7: Top Panel

### 1.8 Dimensions

The dimensions are shown below.

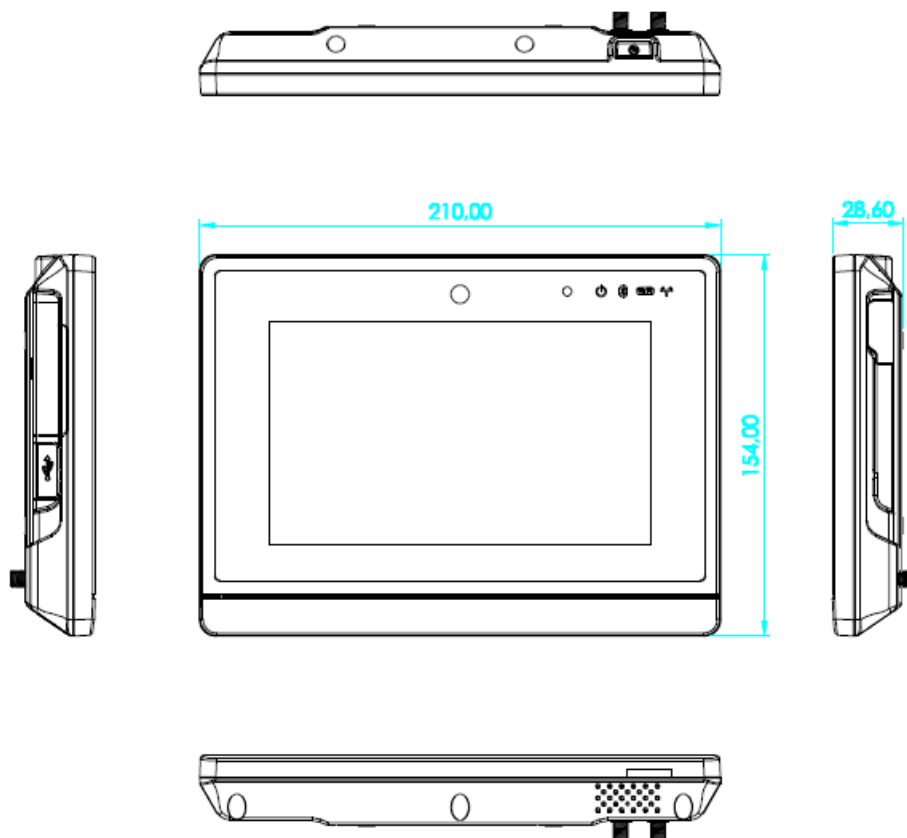

Figure 1-8: Dimensions (unit: mm)

## 1.9 System Specifications

The technical specifications for the IKARPC-07A-BT systems are listed in **Table 1-2**.

System	
<b>CPU</b>	Intel® Atom® processor E3826 (dual-core, 1.46 GHz, 7W TDP)
<b>Memory</b>	On-board 2 GB SDRAM
<b>Storage</b>	One microSD card slot (SD 2.0 compatible, max. 32 GB) One mSATA slot (full-size PCIe Mini, SATA 3Gb/s)
<b>Audio</b>	One 2 W speaker
<b>Camera</b>	2-megapixel front-facing camera
<b>Watchdog Timer</b>	Software programmable supports 1~255 sec. system reset
<b>Real-time Clock</b>	Battery backup RTC
Display	
<b>LCD</b>	7" TFT LCD with LED backlight
<b>Max. Resolution</b>	1024 x 600 (WSVGA)
<b>Brightness (cd/m<sup>2</sup>)</b>	500
<b>Contrast Ratio</b>	700:1
<b>Pixel Pitch (mm)</b>	0.05 (W) x 0.15 (H)
<b>Viewing Angle</b>	130° (H)/140° (V)
<b>Touchscreen</b>	2-point projected capacitive touchscreen with USB interface
<b>Auto-dimming</b>	Ambient light sensor on the front panel
Communication	
<b>LAN</b>	1 x 10/100/1000 Mbps
<b>GPS</b>	Built-in u-blox NEO-M8N GPS module with external antenna connector
<b>Wireless LAN (Optional)</b>	802.11b/g/n 1T1R PCIe Mini Wi-Fi module
<b>Bluetooth (Optional)</b>	Bluetooth v2.1 (combo with WWAN)
<b>WWAN (Optional)</b>	Optional u-blox LISA-U200 3.75G UMTS/HSPA+ module supports: HSPA/UMTS-800/850/1900/2100 MHz Quad-band EDGE/GPRS/GSM-850/900/1800/1900MHz
Power	
<b>Power Input</b>	4-pin (2x2) Molex power connector supports DC or ACC power
<b>DC Power</b>	9 V ~ 30 V DC input via optional cigarette lighter power cable
<b>ACC Power</b>	ACC power on/off mode with software configurable delay time



## IKARPC-07A-BT In-vehicle Panel PC

<b>Power Consumption</b>	12 V @ 1.25 A
<b>Physical Character</b>	
<b>Construction Material</b>	ABS + PC plastic
<b>Mounting</b>	VESA 75 mm x 75 mm
<b>Dimensions (W x H x D)</b>	210 mm x 154 mm x 29 mm
<b>Operation Temperature</b>	-20°C ~ 60°C with air flow
<b>Storage Temperature</b>	-30°C ~ 70°C
<b>Humidity</b>	5% ~ 95%, non-condensing
<b>Weight (Net/Gross)</b>	0.9 kg/2.1 kg
<b>Operating Shock</b>	Half-sine wave shock 5 G, 11 ms, 3 shocks per axis
<b>Operating Vibration</b>	MIL-STD-810G 514.6C-1 (with SSD)
<b>IP Level</b>	IP 54 compliant front panel
<b>Certifications</b>	CE, FCC, e-MARK
<b>Connectors and Buttons</b>	
<b>Antenna Connectors</b>	1 x GPS antenna SMA female connector 1 x 3.75G antenna SMA female connector (optional)
<b>Expansion Slot</b>	2 x SIM card slot
<b>I/O Connector</b>	1 x 9 V~ 30 V DC input connector 1 x USB 2.0 port 1 x USB 3.0 port 1 x HDMI connector
	20-pin connector: 1 x 10/100/1000 Mbps LAN 1 x OBD-II/J1939 1 x USB 2.0
	24-pin connector: 1 x Audio line-out (R+L) 1 x Audio line-in 1 x RS-232 2-bit digital input 2-bit digital output
<b>Button</b>	1 x Power button

**Table 1-2: Technical Specifications**

Chapter

**2**

# Unpacking

---

## IKARPC-07A-BT In-vehicle Panel PC

To unpack the panel PC, follow the steps below:



### **WARNING!**

The front side LCD screen has a protective plastic cover stuck to the screen. Only remove the plastic cover after the system has been properly installed. This ensures the screen is protected during the installation process.

---

**Step 1:** Open the external box.

**Step 2:** Remove the two polystyrene strips that cover the system.

**Step 3:** Lift the IKARPC-07A-BT out of the boxes.

**Step 4:** Take the IKARPC-07A-BT out from the plastic bag.

**Step 5:** Pull the plastic cover off the IKARPC-07A-BT.

**Step 6:** Make sure all the components listed in the packing list are present.

## 2.1 Packing List



### **NOTE:**

If any of the components listed in the checklist below are missing, do not proceed with the installation. Contact the IEI reseller or vendor the IKARPC-07A-BT was purchased from or contact an IEI sales representative directly by sending an email to [sales@ieiworld.com](mailto:sales@ieiworld.com).

---

The IKARPC-07A-BT is shipped with the following components:

Quantity	Item	Image
1	IKARPC-07A-BT in-vehicle panel PC	
1	ACC power cable (P/N: 32002-001900-100-RS)	
1	GPS/GSM antenna (P/N: 32506-000100-100-RS)	
1	User manual CD and driver CD	







**Table 2-1: Packing List**

## 2.2 Optional Items

The following are optional components which may be separately purchased:

Item	Image
802.11/b/g/n wireless kit (assemble-to-order) (P/N: IKARPC-WIFI-KIT01-R10)	

## IKARPC-07A-BT In-vehicle Panel PC

Item	Image
WWAN kit (assemble-to-order) (P/N: IKARPC-3G-KIT01-R10)	
Power adapter with transfer cable (P/N: IVIPOWER-4PIN-R10)	
Cigarette lighter power cable (P/N: 32002-004000-100-RS)	
I/O connector 1 cable (20-pin) (P/N: 32024-003000-100-RS)	
I/O connector 2 cable (24-pin) (P/N: 32124-003700-100-RS)	
OBD-II cable (P/N: 32025-003400-100-RS)	



Item	Image
VESA mount stand (138 mm) (P/N: IVI-MK03-R10)	
Windows Embedded 7 CD (P/N: IKARPC-07A-BT-WES7P-R10)	
Windows Embedded 8 CD (P/N: IKARPC-W10A-WE8S-R10)	

**Table 2-2: Optional Items**

If any of these items are missing or damaged, contact the distributor or sales representative immediately.

Chapter

3

# Installation

---

### 3.1 Anti-static Precautions

---

**WARNING:**

Failure to take ESD precautions during the maintenance of the IKARPC-07A-BT may result in permanent damage to the IKARPC-07A-BT and severe injury to the user.

---

Electrostatic discharge (ESD) can cause serious damage to electronic components, including the IKARPC-07A-BT. Dry climates are especially susceptible to ESD. It is therefore critical that whenever the IKARPC-07A-BT is accessed internally, or any other electrical component is handled, the following anti-static precautions are strictly adhered to.

- ***Wear an anti-static wristband:*** Wearing a simple anti-static wristband can help to prevent ESD from damaging the board.
- ***Self-grounding:*** Before handling the board, touch any grounded conducting material. During the time the board is handled, frequently touch any conducting materials that are connected to the ground.
- ***Use an anti-static pad:*** When configuring the IKARPC-07A-BT, place it on an anti-static pad. This reduces the possibility of ESD damaging the IKARPC-07A-BT.
- ***Only handle the edges of the PCB:*** When handling the PCB, hold the PCB by the edges.

### 3.2 Installation Precautions

When installing the flat panel PC, please follow the precautions listed below:

- **Power turned off:** When installing the flat panel PC, make sure the power is off. Failing to turn off the power may cause severe injury to the body and/or damage to the system.
- **Certified Engineers:** Only certified engineers should install and modify onboard functionalities.

## IKARPC-07A-BT In-vehicle Panel PC

- **Anti-static Discharge:** If a user open the rear panel of the flat panel PC, to configure the jumpers or plug in added peripheral devices, ground themselves first and wear an anti-static wristband.

### 3.3 microSD Card Installation

To install the microSD card, follow the instructions below.

**Step 1:** Remove the retention screw and lift the microSD card slot access panel.



**Figure 3-1: microSD Card Slot Access Panel Retention Screw**

**Step 2:** Locate the microSD card slot. Insert the microSD card into the slot to install it. To remove the microSD card, push the microSD card inwards to release it.



**Figure 3-2: Install microSD Card**

**Step 3:** Replace the microSD card slot access panel.



### 3.4 SIM Card Installation (Optional)

To install the SIM card, follow the instructions below.

**Step 1:** Remove the retention screw and lift the SIM card slot access panel.



**Figure 3-3: SIM Card Slot Access Panel Retention Screw**

**Step 2:** Locate the SIM card slots. The IKARPC-07A-BT has two SIM card slots (**Figure 3-4**). Insert a SIM card into the slot to install it. To remove the SIM card, push the SIM card to release it.

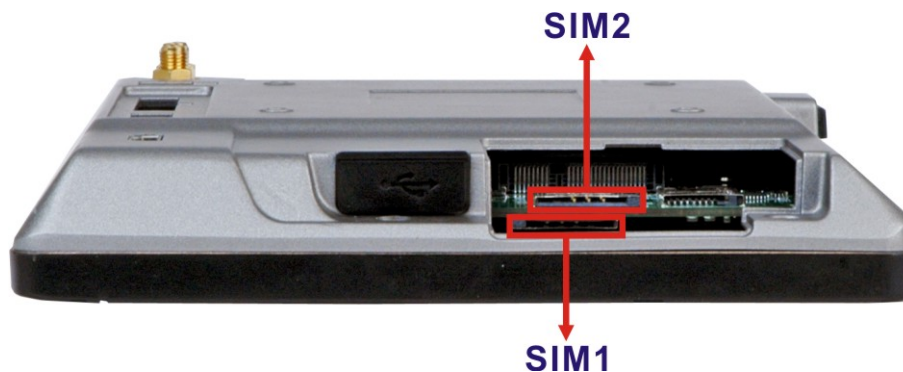

**Figure 3-4: SIM Card Slot Locations**



## IKARPC-07A-BT In-vehicle Panel PC





### WARNING:

The IKARPC-07A-BT is not compatible with a micro-SIM (3FF) adapter or a nano-SIM (4FF) adapter. Please install a mini-SIM (2FF or Standard SIM) card for proper network connection.

**Step 3:** Replace and secure the SIM card slot access panel with the previously removed retention screw.

**Step 4:** Install IEI Mobile AP to designate a SIM card to use. The Mobile AP instruction is described in detail in **Section 4.2**.

**Step 5:** The 3.75G LED indicator on the front panel shows the user which SIM card is being used.

LED	Color	Description
	Yellow	SIM1 is being used for 3.75G connection.
	Red	SIM2 is being used for 3.75G connection.



### NOTE:

Before installing a SIM card for WWAN connection, please make sure a 3.75G module is installed in the PCIe Mini card slot of the IKARPC-07A-BT.

### 3.5 Mounting the System

The IKARPC-07A-BT is VESA (Video Electronics Standards Association) compliant and can be mounted on a mounting device with a 75 mm interface pad. The IKARPC-07A-BT VESA mount retention screw holes are shown in **Figure 3-5**. Refer to the installation guide that came with the mounting device to mount the IKARPC-07A-BT.

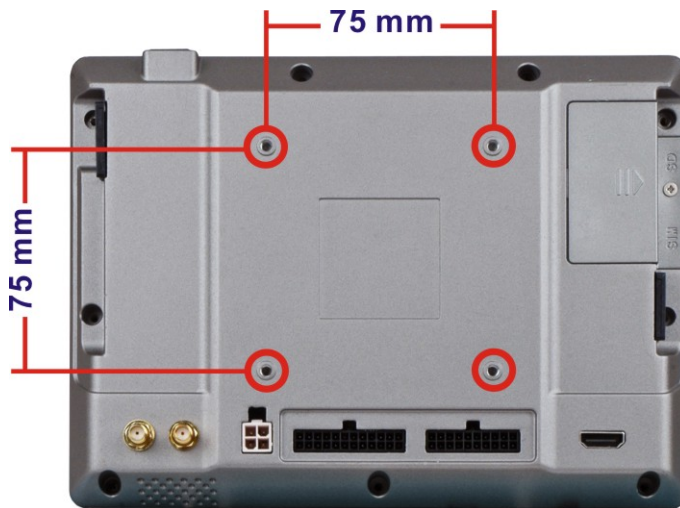

Figure 3-5: VESA Mount Retention Screw Holes



#### NOTE:

When purchasing the mounting device please ensure that it is VESA compliant and that the device has a 75 mm interface pad. If the mounting device is not VESA compliant it cannot be used to support the IKARPC-07A-BT.

---

## IKARPC-07A-BT In-vehicle Panel PC

### 3.6 External I/O Connectors

This section provides an overview of the external I/O connectors of the IKARPC-07A-BT.

#### 3.6.1 I/O Connector 1 (20-pin)

The 20-pin I/O connector (IO 1) supports the following external peripheral devices:

- 1 x GbE LAN
- 1 x OBD-II/J1939
- 1 x USB 2.0

The pinouts for the IO 1 connector are listed in the figure and table below.

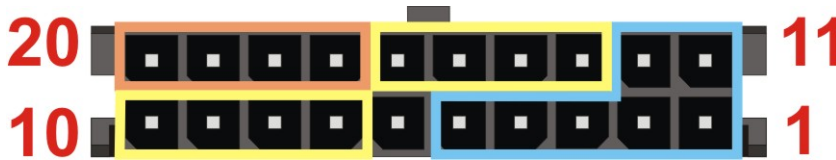

Figure 3-6: IO 1 Connector Pinout Locations

	Pin	Description	Pin	Description	
OBD-II	1	OBD_CAN_H	11	ISO9141-2-K	OBD-II
	2	OBD_CAN_L	12	ISO9141-2-L	
	3	GND	13	LAN1_MDX0-	GbE LAN
	4	J1850_BUS+	14	LAN1_MDX0+	
	5	J1850_BUS-	15	LAN1_MDX1-	
	6	GND	16	LAN1_MDX1+	
GbE LAN	7	LAN1_MDX2-	17	GND	USB 2.0
	8	LAN1_MDX2+	18	USB DATA-	
	9	LAN1_MDX3-	19	USB DATA+	
	10	LAN1_MDX3+	20	USB VCC (+5V)	

Table 3-1: IO 1 Connector Pinouts

User can purchase the optional OBD-II cable (**Figure 3-7**) to connect the IKARPC-07A-BT with the vehicle.



**Figure 3-7: OBD-II Cable**

The pinout locations of OBD-II cable connector are shown below.

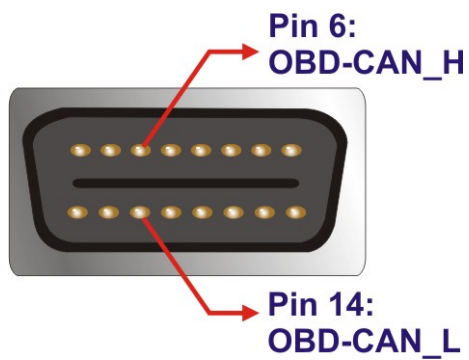

**Figure 3-8: OBD-II Connector Pinouts**

## IKARPC-07A-BT In-vehicle Panel PC

### 3.6.2 I/O Connector 2 (24-pin)

The 24-pin I/O connector (IO 2) supports the following external peripheral devices:

- 1 x Audio line-out (R+L)
- 1 x Audio line-in
- 1 x RS-232
- 2-bit digital input
- 2-bit digital output

The pinouts for the IO 2 connector are listed in the figure and table below.

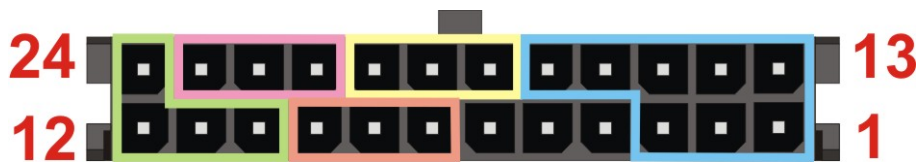

Figure 3-9: IO 2 Connector Pinout Locations

	Pin	Description	Pin	Description	
COM	1	COM_SOUT	13	COM_SI	COM
	2	COM_DTR	14	COM_DSR	
	3	COM_RTS	15	COM_CTS	
	4	NC	16	COM_DCD	
	5	NC	17	COM_RI	
	6	NC	18	DIO_GND	
Digital Output	7	DIO_OUT_1	19	DIO_IN_1	
	8	DIO_OUT_2	20	DIO_IN_2	
	9	DIO_GND	21	AUDIO_GND	Audio Line-in
Audio Line-out	10	AUDIO_GND	22	LINE_IN_L	
	11	SPK_OUT_L	23	LINE_IN_R	
	12	SPK_OUT_R	24	AUDIO_GND	

Table 3-2: IO 2 Connector Pinouts





**NOTE:**

In order to play sounds through the speaker connected to the audio line-out connector, the “External Speaker” BIOS option must be enabled. Please refer to **Section 5.4.2** for detail information.

**3.6.3 HDMI Connector**

The IKARPC-07A-BT has one HDMI connector on the rear panel. The pinouts for the HDMI connector are listed in the figure and table below.

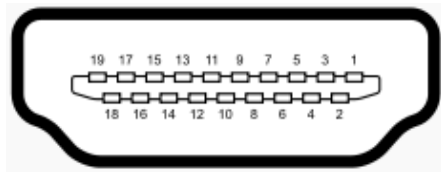

**Figure 3-10: HDMI Connector**

PIN NO.	DESCRIPTION	PIN NO.	DESCRIPTION
1	HDMI_DATA2	2	GND
3	HDMI_DATA2#	4	HDMI_DATA1
5	GND	6	HDMI_DATA1#
7	HDMI_DATA0	8	GND
9	HDMI_DATA0#	10	HDMI_CLK
11	GND	12	HDMI_CLK#
13	N/C	14	N/C
15	HDMI_SCL	16	HDMI_SDA
17	GND	18	+5V
19	HDMI_HPD	20	HDMI_GND
21	HDMI_GND	22	HDMI_GND
23	HDMI_GND		

**Table 3-3: HDMI Connector Pinouts**



## IKARPC-07A-BT In-vehicle Panel PC

### 3.6.4 Power Input Connection

The IKARPC-07A-BT has one 4-pin power input connector on the rear panel. The pinouts for the power input connector are listed in the figure and table below.

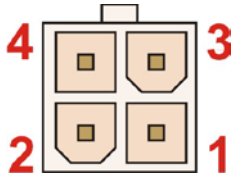

Figure 3-11: Power Input Connector

PIN NO.	DESCRIPTION
1	GND
2	GND
3	POWER
4	ACC

Table 3-4: Power Input Connector Pinouts

The IKARPC-07A-BT can use either ACC power or DC power from the vehicle. To use ACC power, connect the IKARPC-07A-BT to the vehicle through the ACC power cable. See **Figure 3-12**.



Figure 3-12: ACC Power Cable

**[Optional Choice]**

To use DC power, connect the IKARPC-07A-BT to the vehicle cigarette lighter connector through the optional cigarette lighter cable. See **Figure 3-13**.



**Figure 3-13: Optional Cigarette Lighter Cable**

**3.6.5 USB Connector**

The IKARPC-07A-BT has one USB 2.0 port on the left side panel and one USB 3.0 port on the right side panel. The USB 3.0 port has a screw on the side for securing the USB devices, such as barcode scanners and smart card readers. The following diagram shows the USB 3.0 port and the screw on the side panel.

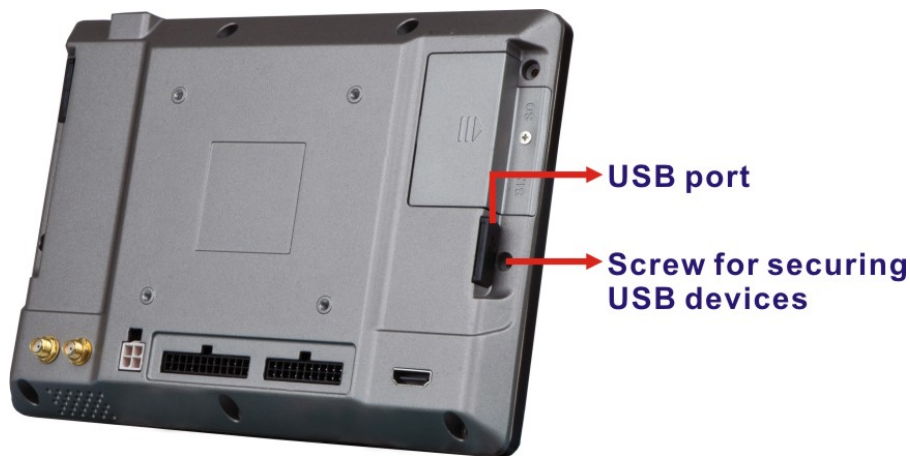

**Figure 3-14: USB Connector**

## IKARPC-07A-BT In-vehicle Panel PC

### 3.7 Power-On Procedure



**WARNING:**





Make sure a power supply with the correct input voltage is being fed into the system. Incorrect voltages applied to the system may cause damage to the internal electronic components and may also cause injury to the user.

To power-on the IKARPC-07A-BT, connect either the ACC power cable or the optional cigarette lighter power cable from the IKARPC-07A-BT to the vehicle. The IKARPC-07A-BT will automatically turn on once the power is connected.

When the system is connected to power source, press the power button on the top panel for 4 – 6 seconds to power on/off the system.

#### 3.7.1 Power State

The following table shows the relation of the power state and vehicle ignition system. The auto start-up and shut down time delay can be set by the BIOS options (please refer to **Section 5.3.4**).

	LOCK	ACC	ON	START
				
<b>ACC Signal</b>	Off	On	On	Off
<b>Car Cigarette Lighter</b>	Off	On	On	Off
<b>5 V Standby Power</b>	Off	On after 1 second	On	On
<b>Auto Start-up</b>	--	After 10~60 seconds (selectable)		--
<b>Auto Shut-down</b>	After 10~180 secs (selectable)	--	--	--

**Table 3-5: Power State and Ignition System**

### 3.8 System Maintenance

If the components of the IKARPC-07A-BT fail, they must be replaced. Please contact the system reseller or vendor to purchase the replacement parts.

---



**NOTE:**

A user cannot replace a motherboard. If the motherboard fails it must be shipped back to IEI to be replaced. Please contact the system vendor, reseller or an IEI sales person directly.

---

Chapter

**4**

# Software Drivers

---



**NOTE:**

The content of the CD may vary throughout the life cycle of the product and is subject to change without prior notice. Visit the IEI website or contact technical support for the latest updates.

## 4.1 Drivers

The utility CD contains drivers for Windows 7 and Windows 8 operating systems. Please select the corresponding drivers for the system.

The following drivers can be installed on the **Windows 7** operating system:

- Chipset
- Graphics
- Audio
- LAN
- WLAN
  - iKarPC-3G-mPCIe: for installing Bluetooth driver, ublox LISA-200 3.75G module driver and IEI Mobile AP application tool
  - ublox\_LISA-U200: 3.75G module driver
  - VIA\_VN9485: wireless LAN module driver
- Bluetooth
- Others:
  - TXE
  - USB 3.0
  - I/O driver

The following drivers can be installed on the **Windows 8** operating system:

- Chipset
- Graphics
- Audio
- LAN
- WLAN



## IKARPC-07A-BT In-vehicle Panel PC

- iKarPC-3G-mPCIe: for installing Bluetooth driver, ublox LISA-200 3.75G module driver and IEI Mobile AP application tool
- ublox\_LISA-U200: 3.75G module driver
- VIA\_VN9485: wireless LAN module driver
- Others:
  - I/O driver

## 4.2 Mobile AP

IEI provides an application tool, Mobile AP, for the users of the IKARPC-07A-BT with the WWAN module installed to manage mobile network and make a phone call.

### 4.2.1 Installation

To install this application tool, please locate the **WLAN** folder in the utility CD. This folder contains two files for different operating systems.

- **IEI\_Mobile\_AP\_Setup\_x86\_vxx.exe** for 32-bit Windows OS
- **IEI\_Mobile\_AP\_Setup\_x64\_vxx.exe** for 64-bit Windows OS

Double click the .exe file that is corresponding to the OS version, then the system starts to extract the file. After extracting, it starts to install the Bluetooth driver followed by the installation of the WWAN module driver, and IEI Mobile AP application tool. It is recommended to follow the step-by-step procedure to install all of these three drivers/applications.



#### NOTE:

After installing the drivers and applications, the IKARPC-07A-BT must be restarted in order to complete the installation.

---

## 4.2.2 Usage

To launch the application, double click the **MobileAP** icon on the Windows desktop. The user interface appears as shown in **Figure 4-1**. The functions are described below.

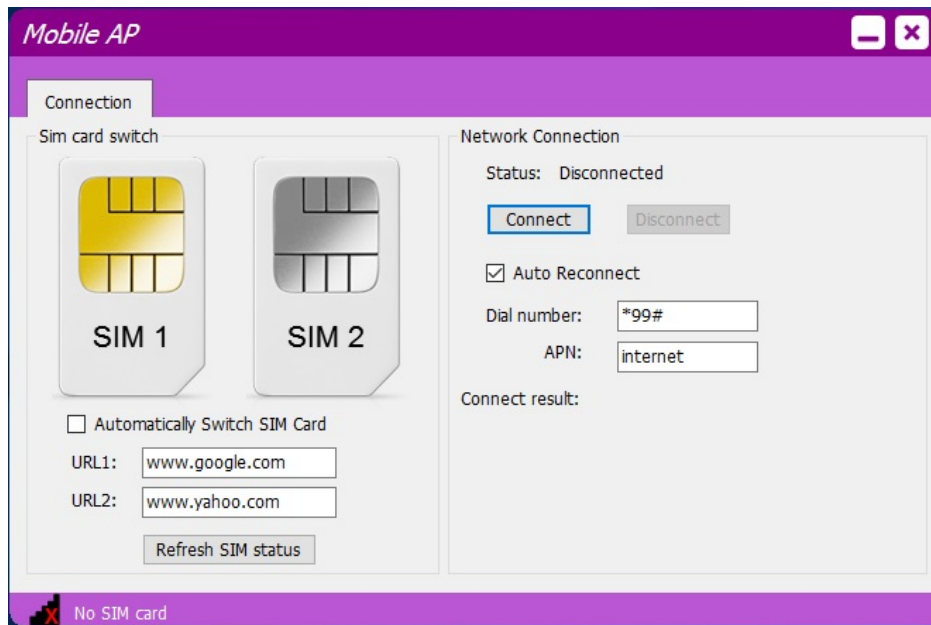

Figure 4-1: Mobile AP – Connection

- **Sim card switch:**
  - Select a SIM card to designate a SIM card to use or click the **Refresh SIM status** button to let the system detect automatically.
  - **Automatically Switch SIM Card:** check to allow the system to ping URL1 and URL2 every 30 seconds. If the system is unable to ping both URLs in three minutes, the system will automatically switch to the other SIM card.
- **Network Connection:**
  - **Status:** shows the connection status. Click the **Connect** button to connect the selected SIM card to network.
  - **Auto Reconnect:** allows the system to reconnect automatically.
  - **Dial number:** provided by the ISP for mobile network. The default value is **\*99#**.
  - **APN (Access Point Name):** provided by the ISP for mobile network. The default value is **internet**.
  - **Connect result:** displays the connection result.

Chapter

**5**

# **BIOS**

---

## 5.1 Introduction

The BIOS is programmed onto the BIOS chip. The BIOS setup program allows changes to certain system settings. This chapter outlines the options that can be changed.



### NOTE:

Some of the BIOS options may vary throughout the life cycle of the product and are subject to change without prior notice.

---

### 5.1.1 Starting Setup

The UEFI BIOS is activated when the computer is turned on. The setup program can be activated in one of two ways.

1. Press the **DEL** or **F2** key as soon as the system is turned on or
2. Press the **DEL** or **F2** key when the “**Press DEL or F2 to enter SETUP**” message appears on the screen.

If the message disappears before the **DEL** or **F2** key is pressed, restart the computer and try again.

### 5.1.2 Using Setup

Use the arrow keys to highlight items, press **ENTER** to select, use the PageUp and PageDown keys to change entries, press **F1** for help and press **ESC** to quit. Navigation keys are shown in.

Key	Function
Up arrow	Move to previous item
Down arrow	Move to next item
Left arrow	Move to the item on the left hand side
Right arrow	Move to the item on the right hand side

## IKARPC-07A-BT In-vehicle Panel PC

Key	Function
+	Increase the numeric value or make changes
-	Decrease the numeric value or make changes
Page Up key	Move to the previous page
Page Dn key	Move to the next page
Esc key	Main Menu – Quit and not save changes into CMOS Status Page Setup Menu and Option Page Setup Menu -- Exit current page and return to Main Menu
F1	General help, only for Status Page Setup Menu and Option Page Setup Menu
F2	Load previous values
F3	Load optimized defaults
F4	Save changes and Exit BIOS

Table 5-1: BIOS Navigation Keys

### 5.1.3 Getting Help

When **F1** is pressed a small help window describing the appropriate keys to use and the possible selections for the highlighted item appears. To exit the Help Window press **Esc** or the **F1** key again.

### 5.1.4 BIOS Menu Bar

The **menu bar** on top of the BIOS screen has the following main items:

- Main – Changes the basic system configuration.
- Advanced – Changes the advanced system settings.
- Chipset – Changes the chipset settings.
- Security – Sets User and Supervisor Passwords.
- Boot – Changes the system boot configuration.
- Save & Exit – Selects exit options and loads default settings



The following sections completely describe the configuration options found in the menu items at the top of the BIOS screen and listed above.

### 5.2 Main

The **Main** BIOS menu (**BIOS Menu 1**) appears when the **BIOS Setup** program is entered. The **Main** menu gives an overview of the basic system information.

Aptio Setup Utility - Copyright (C) 2015 American Megatrends, Inc.						
Main	Advanced	Chipset	Security	Boot	Save & Exit	
BIOS Information					Set the Date. Use Tab to switch between Data elements.  ----- →←: Select Screen ↑ ↓: Select Item Enter: Select +/-: Change Opt. F1: General Help F2: Previous Values F3: Optimized Defaults F4: Save & Exit ESC: Exit	
BIOS Vendor			American Megatrends			
Core Version			5.010			
Compliancy			UEFI 2.4; PI 1.3			
Project Version			Z245AI12.ROM			
Build Date and Time			03/25/2015 13:24:53			
CPU Configuration						
Microcode Patch			901			
BayTrial SoC			D0 Stepping			
Memory Information						
Total Memory			2048 MB (LPDDR3)			
TXE Information						
Sec RC Version			00.05.00.00			
TXE FW Version			01.00.02.1060			
System Date			[Fri 05/22/2015]			
System Time			[15:34:41]			
Access Level			Administrator			
Version 2.17.1245. Copyright (C) 2015 American Megatrends, Inc.						

#### BIOS Menu 1: Main

##### → BIOS Information

The **BIOS Information** lists a brief summary of the BIOS. The fields in **BIOS Information** cannot be changed. The items shown in the system overview include:

- **BIOS Vendor:** Installed BIOS vendor
- **Core Version:** Current BIOS version
- **Compliancy:** Current compliant version
- **Project Version:** the board version

## IKARPC-07A-BT In-vehicle Panel PC

- **Build Date:** Date the current BIOS version was made

### → CPU Information

The **CPU Information** lists a brief summary of the CPU. The fields in **CPU Information** cannot be changed. The items shown in the system overview include:

- **Microcode Patch:** Installed microcode patch
- **BayTrail SoC:** CPU stepping level

### → Memory Information

The **Memory Information** lists the total memory of the system

### → TXE Information

The **TXE Information** lists a brief summary of Intel® Trusted Execution Engine (TXE). The fields in **TXE Information** cannot be changed. The items shown in the system overview include:

- **Sec RC Version:** Current sec reference code version
- **TXE FW Version:** Current Intel® TXE firmware version

### → System Date [xx/xx/xx]

Use the **System Date** option to set the system date. Manually enter the day, month and year.

### → System Time [xx:xx:xx]

Use the **System Time** option to set the system time. Manually enter the hours, minutes and seconds.

### 5.3 Advanced

Use the **Advanced** menu (**BIOS Menu 2**) to configure the CPU and peripheral devices through the following sub-menus:



**WARNING:**

Setting the wrong values in the sections below may cause the system to malfunction. Make sure that the settings made are compatible with the hardware.

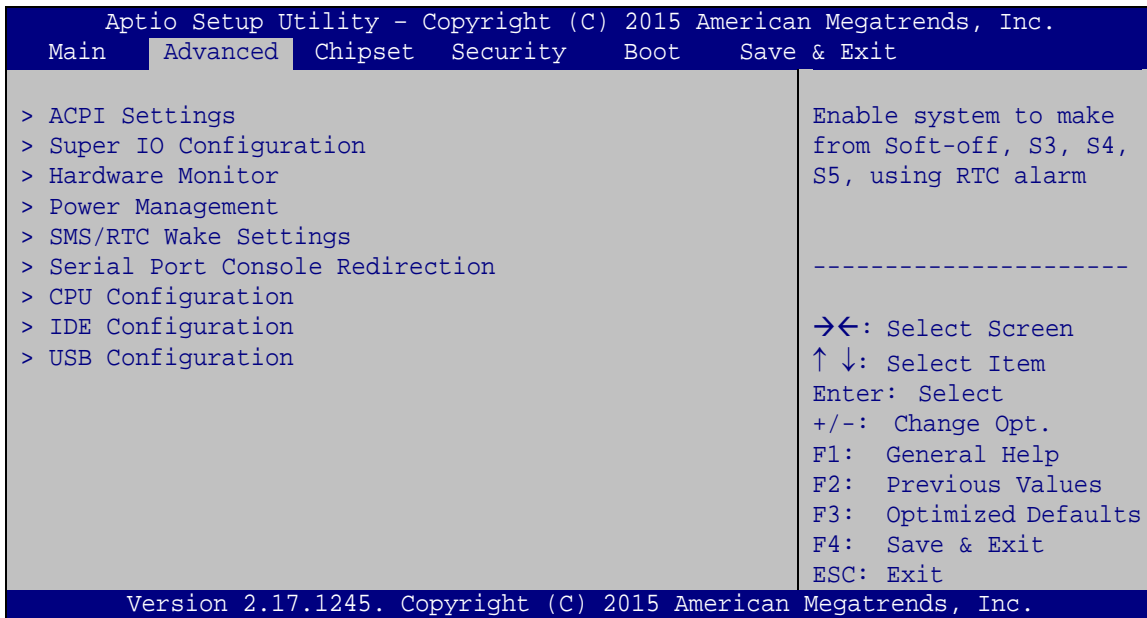

**BIOS Menu 2: Advanced**

## IKARPC-07A-BT In-vehicle Panel PC

### 5.3.1 ACPI Settings

The **ACPI Settings** menu (**BIOS Menu 3**) configures the Advanced Configuration and Power Interface (ACPI) options.

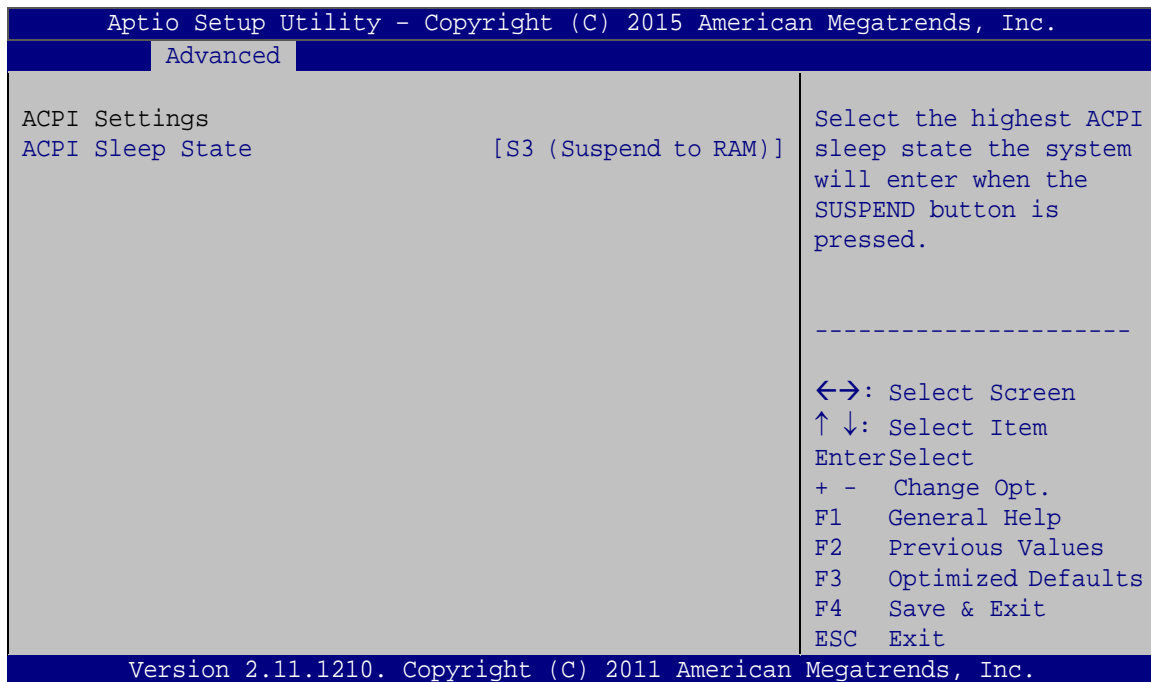

#### BIOS Menu 3: ACPI Settings

#### → ACPI Sleep State [S3 (Suspend to RAM)]

Use the **ACPI Sleep State** option to specify the sleep state the system enters when it is not being used.

- **S3 (Suspend to DEFAULT RAM)** The caches are flushed and the CPU is powered off. Power to the RAM is maintained. The computer returns slower to a working state, but more power is saved.

### 5.3.2 Super IO Configuration

Use the **Super IO Configuration** menu (**BIOS Menu 4**) to set or change the configurations for the serial ports.

```

Aptio Setup Utility - Copyright (C) 2015 American Megatrends, Inc.
  Advanced
Super IO Configuration                               Set Parameters of Serial
                                                    Port 1 (COMA)
Super IO Chip                                     F81866
> Serial Port 1 Configuration
                                                    -----
                                                    →←: Select Screen
                                                    ↑ ↓: Select Item
                                                    Enter: Select
                                                    +/-: Change Opt.
                                                    F1:  General Help
                                                    F2:  Previous Values
                                                    F3:  Optimized Defaults
                                                    F4:  Save & Exit
                                                    ESC: Exit
Version 2.17.1245. Copyright (C) 2015 American Megatrends, Inc.
    
```

**BIOS Menu 4: Super IO Configuration**

#### 5.3.2.1 Serial Port 1 Configuration

Use the **Serial Port 1 Configuration** menu (**BIOS Menu 5**) to configure the serial port 1.

```

Aptio Setup Utility - Copyright (C) 2015 American Megatrends, Inc.
  Advanced
Serial Port 1 Configuration                       Enable or Disable Serial
                                                    Port (COM)
Serial Port                                     [Enabled]
Device Settings                                IO=3F8h; IRQ=4
Change Settings                                 [Auto]
                                                    -----
                                                    →←: Select Screen
                                                    ↑ ↓: Select Item
                                                    Enter: Select
                                                    +/-: Change Opt.
                                                    F1:  General Help
                                                    F2:  Previous Values
                                                    F3:  Optimized Defaults
                                                    F4:  Save & Exit
                                                    ESC: Exit
Version 2.17.1245. Copyright (C) 2015 American Megatrends, Inc.
    
```

**BIOS Menu 5: Serial Port 1 Configuration**



## IKARPC-07A-BT In-vehicle Panel PC

### → Serial Port [Enabled]

Use the **Serial Port** option to enable or disable the serial port.

- **Disabled**                      Disable the serial port
- **Enabled**      **DEFAULT**      Enable the serial port

### → Change Settings [Auto]

Use the **Change Settings** option to change the serial port IO port address and interrupt address.

- **Auto**              **DEFAULT**      The serial port IO port address and interrupt address are automatically detected.
- **IO=3F8h;**  
**IRQ=4**                      Serial Port I/O port address is 3F8h and the interrupt address is IRQ4
- **IO=3F8h;**  
**IRQ=3, 4,**  
**5, 6, 7, 9,**  
**10, 11, 12**                      Serial Port I/O port address is 3F8h and the interrupt address is IRQ3, 4, 5, 6, 7, 9, 10, 11, 12
- **IO=2F8h;**  
**IRQ=3, 4,**  
**5, 6, 7, 9,**  
**10, 11, 12**                      Serial Port I/O port address is 2F8h and the interrupt address is IRQ3, 4, 5, 6, 7, 9, 10, 11, 12
- **IO=3E8h;**  
**IRQ=3, 4,**  
**5, 6, 7, 9,**  
**10, 11, 12**                      Serial Port I/O port address is 3E8h and the interrupt address is IRQ3, 4, 5, 6, 7, 9, 10, 11, 12
- **IO=2E8h;**  
**IRQ=3, 4,**  
**5, 6, 7, 9,**  
**10, 11, 12**                      Serial Port I/O port address is 2E8h and the interrupt address is IRQ3, 4, 5, 6, 7, 9, 10, 11, 12

### 5.3.3 Hardware Monitor

The **Hardware Monitor** menu (**BIOS Menu 6**) displays the CPU and system temperatures.

```

Aptio Setup Utility - Copyright (C) 2015 American Megatrends, Inc.
-----
Advanced
-----
PC Health Status

CPU Temperature           : +44 C
System Temperature       : +39 C
+SOC_VCC                  : +0.808 V
+V5S                      : +5.061 V
+12S                     : +12.646 V
+1.5S                    : +1.504 V
VCC3V                    : +3.328 V
VSB3V                    : +3.344 V
VSB5V                    : +5.040 V

-----
-><: Select Screen
↑↓: Select Item
Enter: Select
+/-: Change Opt.
F1: General Help
F2: Previous Values
F3: Optimized Defaults
F4: Save & Exit
ESC: Exit
-----
Version 2.17.1245. Copyright (C) 2015 American Megatrends, Inc.
  
```

#### BIOS Menu 6: Hardware Monitor

##### → PC Health Status

The following system parameters and values are shown. The system parameters that are monitored are:

- CPU Temperature
- System Temperature
- Voltages:
  - +SOC\_VCC
  - +V5S
  - +12S
  - +1.5S
  - VCC3V
  - VSB3V
  - VSB5V

## IKARPC-07A-BT In-vehicle Panel PC

### 5.3.4 Power Management

Use the **Power Management** menu (**BIOS Menu 7**) to configure the power management function.

```

Aptio Setup Utility - Copyright (C) 2015 American Megatrends, Inc.
  Advanced
Current Voltage           : +12.1 V
Low Voltage Warning      [9V]
Set Low Voltage Warning  (8V~37V)
*** Delay Time Setting ***
Auto Power On Delay      [10 sec]
Auto Power Off Delay     [20 sec]
-----
-><: Select Screen
↑↓: Select Item
Enter: Select
+/-: Change Opt.
F1: General Help
F2: Previous Values
F3: Optimized Defaults
F4: Save & Exit
ESC: Exit
Version 2.17.1245. Copyright (C) 2015 American Megatrends, Inc.

```

#### BIOS Menu 7: Power Management

##### → Low Voltage Warning [9V]

Use the **Low Voltage Warning** option to set the low voltage warning from 8V to 37V. If the system voltage is lower than the value set here, the power LED on the system front panel will blink at regular intervals (refer to **Section 1.3.1**) to warn users.

##### → Auto Power On Delay [10 sec]

Use the **Auto Power On Delay** option to set the automatic power-on delay time. Configuration options are listed below.

- 10 sec    **DEFAULT**
- 30 sec
- 1 min
- 5 min
- 10 min
- 15 min
- 30 min

- 1 hour

### → Auto Power Off Delay [20 sec]

Use the **Auto Power Off Delay** option to set the automatic power-off delay time. Configuration options are listed below.

- 20 sec **DEFAULT**
- 1 min
- 5 min
- 10 min
- 30 min
- 1 hour
- 6 hour
- 18 hour

### 5.3.5 SMS/RTC Wake Settings

The **SMS/RTC Wake Settings** menu (**BIOS Menu 8**) enables the system to wake at the specified time.

```

Aptio Setup Utility - Copyright (C) 2015 American Megatrends, Inc.
Advanced
Wake system with SMS                [Disabled]
Wake system with Fixed Time         [Disabled]
-----
-><: Select Screen
↑↓: Select Item
Enter: Select
+/-: Change Opt.
F1: General Help
F2: Previous Values
F3: Optimized Defaults
F4: Save & Exit
ESC: Exit
Version 2.17.1245. Copyright (C) 2015 American Megatrends, Inc.
    
```

**BIOS Menu 8: SMS/RTC Wake Settings**

## IKARPC-07A-BT In-vehicle Panel PC

### → Wake system with SMS [Disabled]

Use the **Wake system with SMS** option to enable or disable the system wake on SMS event.

- **Disabled**      **DEFAULT**      The SMS cannot generate a wake event
- **Enabled**                      The SMS can generate a wake event

### → Wake system with Fixed Time [Disabled]

Use the **Wake system with Fixed Time** option to enable or disable the system wake on alarm event.

- **Disabled**      **DEFAULT**      The real time clock (RTC) cannot generate a wake event
- **Enabled**                      If selected, the **Wake up every day** option appears allowing you to enable to disable the system to wake every day at the specified time. Besides, the following options appear with values that can be selected:

Wake up every day

Wake up date

Wake up hour

Wake up minute

Wake up second

After setting the alarm, the computer turns itself on from a suspend state when the alarm goes off.

## 5.3.6 Serial Port Console Redirection

The **Serial Port Console Redirection** menu (**BIOS Menu 9**) allows the console redirection options to be configured. Console redirection allows users to maintain a system remotely by re-directing keyboard input and text output through the serial port.



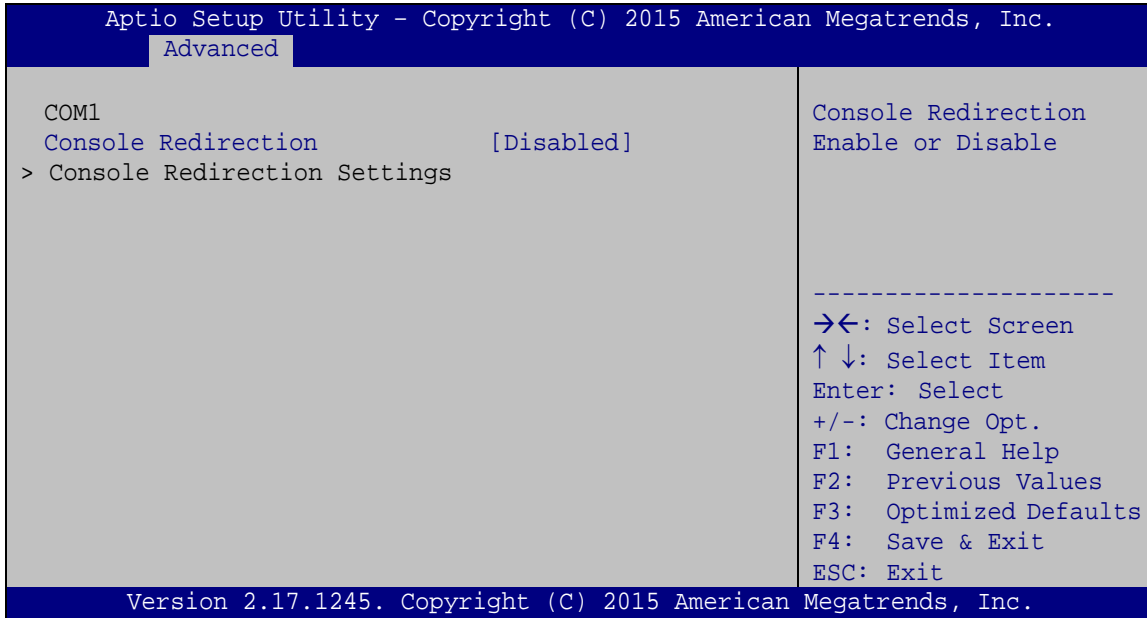

## BIOS Menu 9: Serial Port Console Redirection

### → Console Redirection [Disabled]

Use **Console Redirection** option to enable or disable the console redirection function.

- **Disabled**      **DEFAULT**      Disabled the console redirection function
- **Enabled**                      Enabled the console redirection function

The following options are available only when the **Console Redirection** option is enabled.

### → Terminal Type [ANSI]

Use the **Terminal Type** option to specify the remote terminal type.

- **VT100**                      The target terminal type is VT100
- **VT100+**                      The target terminal type is VT100+
- **VT-UTF8**                      The target terminal type is VT-UTF8
- **ANSI**                      **DEFAULT**      The target terminal type is ANSI

## IKARPC-07A-BT In-vehicle Panel PC

### → Bits per second [115200]

Use the **Bits per second** option to specify the serial port transmission speed. The speed must match the other side. Long or noisy lines may require lower speeds.

- |   |               |                |  |
|---|---------------|----------------|--|
| → | <b>9600</b>   |                | Sets the serial port transmission speed at 9600.   |
| → | <b>19200</b>  |                | Sets the serial port transmission speed at 19200.  |
| → | <b>38400</b>  |                | Sets the serial port transmission speed at 38400.  |
| → | <b>57600</b>  |                | Sets the serial port transmission speed at 57600.  |
| → | <b>115200</b> | <b>DEFAULT</b> | Sets the serial port transmission speed at 115200. |

### → Data Bits [8]

Use the **Data Bits** option to specify the number of data bits.

- |   |          |                |                          |
|---|----------|----------------|--------------------------|
| → | <b>7</b> |                | Sets the data bits at 7. |
| → | <b>8</b> | <b>DEFAULT</b> | Sets the data bits at 8. |

### → Parity [None]

Use the **Parity** option to specify the parity bit that can be sent with the data bits for detecting the transmission errors.

- |   |              |                |   |
|---|--------------|----------------|---|
| → | <b>None</b>  | <b>DEFAULT</b> | No parity bit is sent with the data bits.                                 |
| → | <b>Even</b>  |                | The parity bit is 0 if the number of ones in the data bits is even.       |
| → | <b>Odd</b>   |                | The parity bit is 0 if the number of ones in the data bits is odd.        |
| → | <b>Mark</b>  |                | The parity bit is always 1. This option does not provide error detection. |
| → | <b>Space</b> |                | The parity bit is always 0. This option does not provide error detection. |



## IKARPC-07A-BT In-vehicle Panel PC

- **Min CPU Speed:** Lists the minimum CPU processing speed.
- **Processor Cores:** Lists the number of the processor core
- **Intel HT Technology:** Indicates if Intel HT Technology is supported by the CPU.
- **Intel VT-x Technology:** Indicates if Intel VT-x Technology is supported by the CPU.
- **L1 Data Cache:** Lists the amount of data storage space on the L1 cache.
- **L1 Code Cache:** Lists the amount of code storage space on the L1 cache.
- **L2 Cache:** Lists the amount of storage space on the L2 cache.
- **L3 Cache:** Lists the amount of storage space on the L3 cache.
- **64-bit:** Indicates if 64-bit OS is supported by the CPU.

### ➔ **Intel Virtualization Technology [Disabled]**

Use the **Intel Virtualization Technology** option to enable or disable virtualization on the system. When combined with third party software, Intel® Virtualization technology allows several OSs to run on the same system at the same time.

- ➔ **Disabled**                      **DEFAULT**      Disables Intel Virtualization Technology.
- ➔ **Enabled**    Enables Intel Virtualization Technology.

### ➔ **EIST [Enabled]**

Use the **EIST** option to enable or disable Enhanced Intel SpeedStep® Techonology (EIST).

- ➔ **Disabled**    Disables Enhanced Intel SpeedStep® Techonology.
- ➔ **Enabled**                      **DEFAULT**      Enables Enhanced Intel SpeedStep® Techonology.

### 5.3.8 IDE Configuration

Use the **IDE Configuration** menu (**BIOS Menu 11**) to change and/or set the configuration of the SATA devices installed in the system.

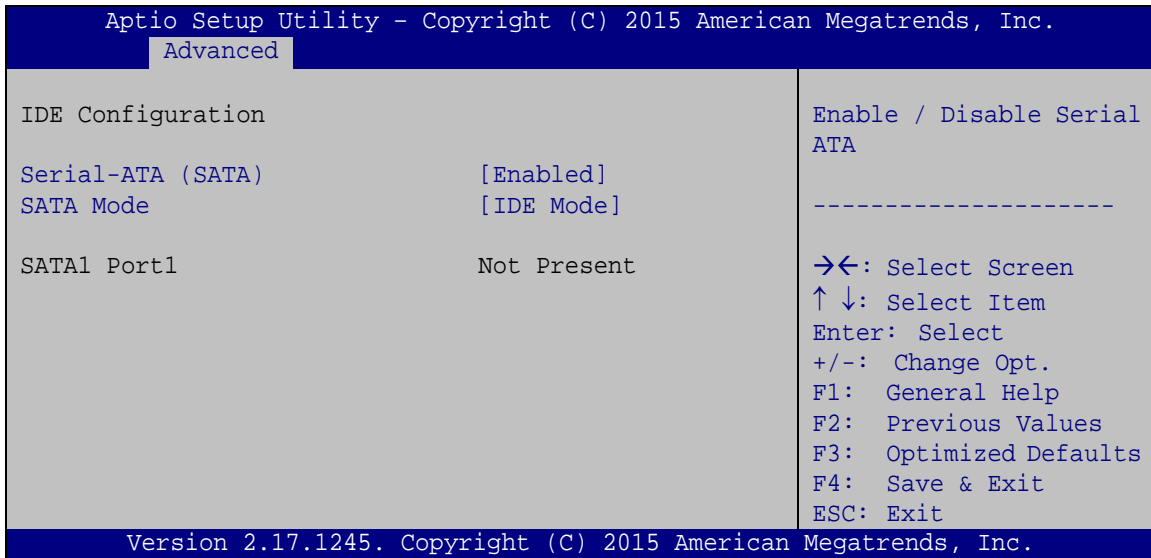

#### BIOS Menu 11: IDE Configuration

##### → Serial-ATA (SATA) [Enabled]

Use the **Serial-ATA (SATA)** option to configure the SATA controller.

- **Enabled**      **DEFAULT**      Enables the on-board SATA controller.
- **Disabled**                      Disables the on-board SATA controller.

##### → SATA Mode [IDE Mode]

Use the **SATA Mode** option to configure SATA devices as normal IDE or AHCI devices.

- **IDE Mode**      **DEFAULT**      Configures SATA devices as normal IDE device.
- **AHCI Mode**                      Configures SATA devices as AHCI device.



## IKARPC-07A-BT In-vehicle Panel PC

### 5.3.9 USB Configuration

Use the **USB Configuration** menu (**BIOS Menu 12**) to read USB configuration information and configure the USB settings.

```

Aptio Setup Utility - Copyright (C) 2012 American Megatrends, Inc.
  Advanced
USB Configuration
USB Devices:
  1 Keyboard, 1 Mouse, 1 Point, 3 Hubs
Legacy USB Support          [Enabled]
-----
-><: Select Screen
↑↓: Select Item
Enter: Select
+/-: Change Opt.
F1: General Help
F2: Previous Values
F3: Optimized Defaults
F4: Save & Exit
ESC: Exit
Version 2.17.1245. Copyright (C) 2015 American Megatrends, Inc.
  
```

#### BIOS Menu 12: USB Configuration

##### ➔ Legacy USB Support [Enabled]

Use the **Legacy USB Support** BIOS option to enable USB mouse and USB keyboard support.

Normally if this option is not enabled, any attached USB mouse or USB keyboard does not become available until a USB compatible operating system is fully booted with all USB drivers loaded. When this option is enabled, any attached USB mouse or USB keyboard can control the system even when there is no USB driver loaded onto the system.

- ➔ **Enabled**      **DEFAULT**      Legacy USB support enabled
- ➔ **Disabled**                      Legacy USB support disabled
- ➔ **Auto**                              Legacy USB support disabled if no USB devices are connected

## 5.4 Chipset

Use the **Chipset** menu (**BIOS Menu 13**) to access the North Bridge and South Bridge configuration menus.



### **WARNING!**

Setting the wrong values for the Chipset BIOS selections in the Chipset BIOS menu may cause the system to malfunction.

```

Aptio Setup Utility - Copyright (C) 2015 American Megatrends, Inc.
Main   Advanced  Chipset  Security  Boot   Save & Exit
-----
> North Bridge
> South Bridge

Host Bridge Parameters
-----
-><: Select Screen
↑ ↓: Select Item
Enter: Select
+/-: Change Opt.
F1: General Help
F2: Previous Values
F3: Optimized Defaults
F4: Save & Exit
ESC: Exit

Version 2.17.1245. Copyright (C) 2015 American Megatrends, Inc.
    
```

**BIOS Menu 13: Chipset**

## IKARPC-07A-BT In-vehicle Panel PC

### 5.4.1 North Bridge Configuration

Use the **North Bridge** menu (**BIOS Menu 14**) to configure the north bridge chipset.

```

Aptio Setup Utility - Copyright (C) 2015 American Megatrends, Inc.
  Chipset
-----
> Intel IGD Configuration          Config Intel IGD
Memory Information                Settings.
Total Memory                      2048 MB (LPDDR3)
DIMM1                             2048 MB (LPDDR3)
-----
<->: Select Screen
↑ ↓: Select Item
EnterSelect
+ -  Change Opt.
F1   General Help
F2   Previous Values
F3   Optimized Defaults
F4   Save & Exit
ESC  Exit

Version 2.15.1236. Copyright (C) 2012 American Megatrends, Inc.
  
```

**BIOS Menu 14: North Bridge**

### 5.4.1.1 Intel IGD Configuration

Use the **Intel IGD Configuration** submenu (**BIOS Menu 15**) to configure the graphics settings.

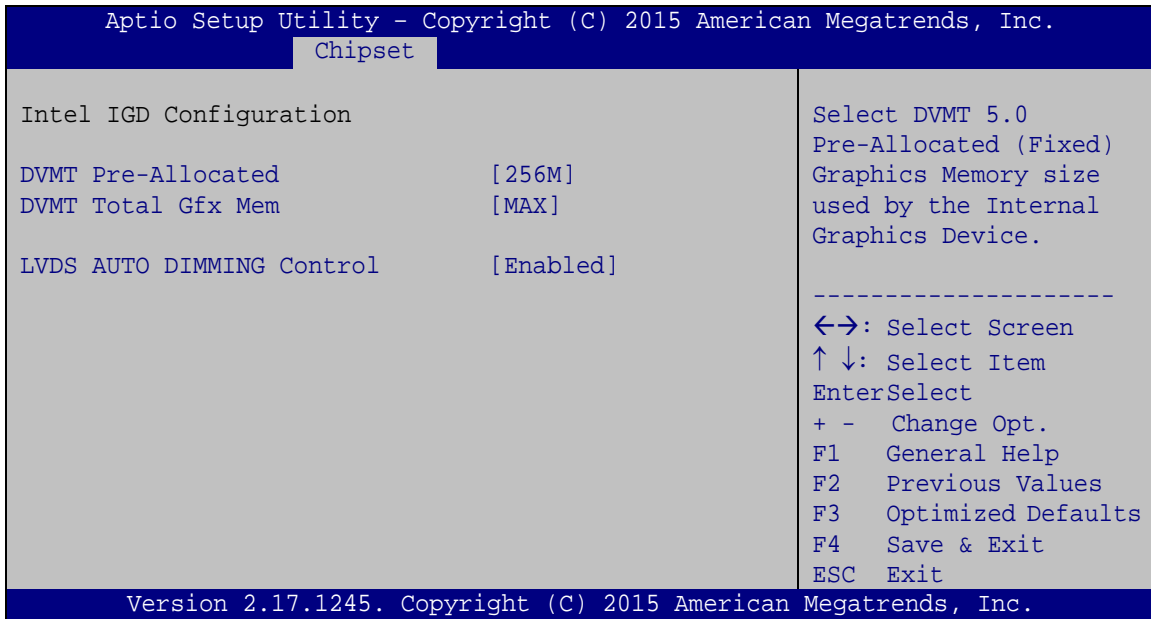

#### BIOS Menu 15: Intel IGD Configuration

##### → DVMT Pre-Allocated [256M]

Use the **DVMT Pre-Allocated** option to specify the amount of system memory that can be used by the internal graphics device.

- |   |             |                |   |
|---|-------------|----------------|---|
| → | <b>64M</b>  |                | 64 MB of memory used by internal graphics device  |
| → | <b>128M</b> |                | 128 MB of memory used by internal graphics device |
| → | <b>256M</b> | <b>DEFAULT</b> | 256 MB of memory used by internal graphics device |
| → | <b>512M</b> |                | 512 MB of memory used by internal graphics device |

## IKARPC-07A-BT In-vehicle Panel PC

### → DVMT Total Gfx Mem [MAX]

Use the **DVMT Total Gfx Mem** option to specify the maximum amount of memory that can be allocated as graphics memory. Configuration options are listed below.

- 128MB
- 256MB
- MAX      **Default**

### → LVDS AUTO DIMMING Control [Enabled]

Use the **LVDS AUTO DIMMING Control** enable or disable the auto dimming function.

- **Enabled**    **DEFAULT**    The auto dimming function is enabled
- **Disabled**                    The auto dimming function is disabled

## 5.4.2 South Bridge Configuration

Use the **South Bridge** menu (**BIOS Menu 16**) to configure the audio device connected to the system.

```

Aptio Setup Utility - Copyright (C) 2015 American Megatrends, Inc.
Chipset
-----
Audio Configuration
Audio Controller                    [Enabled]
External Speaker                    [Enabled]
XHCI Mode                            [Smart Auto]
Control Detection of the
Azalia device. Disabled
= Azalia will be
unconditionally
disabled. Enabled =
Azalia will be
unconditionally
Enabled.
-----
←→: Select Screen
↑ ↓: Select Item
EnterSelect
+ - Change Opt.
F1 General Help
F2 Previous Values
F3 Optimized Defaults
F4 Save & Exit
ESC Exit
Version 2.17.1245. Copyright (C) 2015 American Megatrends, Inc.

```

**BIOS Menu 16: South Bridge**



**→ Audio Controller [Enabled]**

Use the **Audio Controller** option to enable or disable the High Definition Audio controller.

- Disabled**                      The onboard High Definition Audio controller is disabled
- Enabled    DEFAULT**        The onboard High Definition Audio controller automatically detected and enabled

**→ External Speaker [Enabled]**

Use the **External Speaker** option to enable or disable the external speaker connected to the system.

- Disabled**                      The external speaker is disabled
- Enabled    DEFAULT**        The external speaker is enabled

**→ XHCI Mode [Smart Auto]**

Use the **XHCI Mode** BIOS option to configure the USB xHCI (USB 3.0) controller.

- Enabled**                      Enable the xHCI controller. USB 3.0 ports behave as USB 3.0 ports.
- Smart        DEFAULT**              Allow the use of USB 3.0 devices prior to OS boot. USB 3.0 ports function as USB 3.0 ports even during a reboot.  
**Auto**

## IKARPC-07A-BT In-vehicle Panel PC

### 5.5 Security

Use the **Security** menu (**BIOS Menu 17**) to set system and user passwords.

```

Aptio Setup Utility - Copyright (C) 2015 American Megatrends, Inc.
Main   Advanced  Chipset  Security  Boot   Save & Exit

Password Description
-----
If ONLY the Administrator's password is set,
then this only limits access to Setup and is
only asked for when entering Setup.
If ONLY the User's password is set, then this
is a power on password and must be entered to
boot or enter Setup. In Setup the User will
have Administrator rights.
The password length must be:
Minimum length           3
Maximum length           20

Administrator Password
User Password

Set Administrator
Password

-----
-><: Select Screen
↑ ↓: Select Item
Enter: Select
+/-: Change Opt.
F1:  General Help
F2:  Previous Values
F3:  Optimized Defaults
F4:  Save & Exit
ESC: Exit

Version 2.17.1245. Copyright (C) 2015 American Megatrends, Inc.

```

#### BIOS Menu 17: Security

##### ➔ Administrator Password

Use the **Administrator Password** to set or change a administrator password.

##### ➔ User Password

Use the **User Password** to set or change a user password.

## 5.6 Boot

Use the **Boot** menu (**BIOS Menu 18**) to configure system boot options.

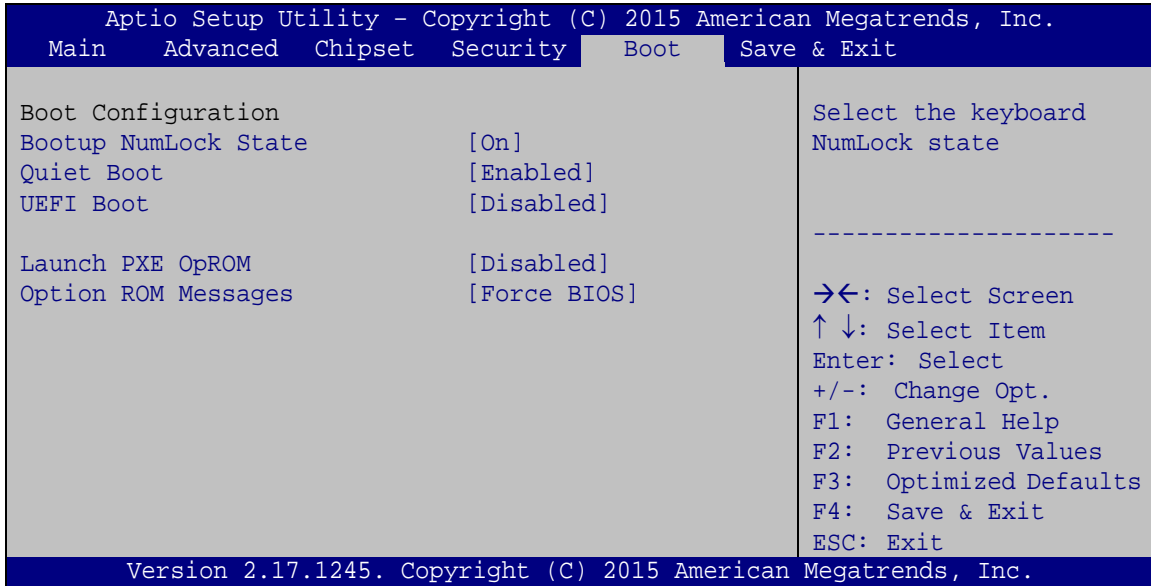

### BIOS Menu 18: Boot

#### → Bootup NumLock State [On]

Use the **Bootup NumLock State** BIOS option to specify if the number lock setting must be modified during boot up.

- **On**                      **DEFAULT**                      Allows the Number Lock on the keyboard to be enabled automatically when the computer system boots up. This allows the immediate use of the 10-key numeric keypad located on the right side of the keyboard. To confirm this, the Number Lock LED light on the keyboard is lit.
- **Off**                                      Does not enable the keyboard Number Lock automatically. To use the 10-keys on the keyboard, press the Number Lock key located on the upper left-hand corner of the 10-key pad. The Number Lock LED on the keyboard lights up when the Number Lock is engaged.

## IKARPC-07A-BT In-vehicle Panel PC

### → Quiet Boot [Enabled]

Use the **Quiet Boot** BIOS option to select the screen display when the system boots.

- **Disabled** Normal POST messages displayed
- **Enabled** **DEFAULT** OEM Logo displayed instead of POST messages

### → UEFI Boot [Disabled]

Use the **UEFI Boot** BIOS option to allow the system to boot from the UEFI devices.

- **Enabled** Enables to boot from the UEFI devices.
- **Disabled** **DEFAULT** Disables to boot from the UEFI devices.

### → Launch PXE OpROM [Disabled]

Use the **Launch PXE OpROM** option to enable or disable boot option for legacy network devices.

- **Disabled** **DEFAULT** Ignore all PXE Option ROMs
- **Enabled** Load PXE Option ROMs.

### → Option ROM Messages [Force BIOS]

Use the **Option ROM Messages** option to set the Option ROM display mode.

- **Force BIOS** **DEFAULT** Sets display mode to force BIOS.
- **Keep Current** Sets display mode to current.

## 5.7 Save & Exit

Use the **Save & Exit** menu (**BIOS Menu 19**) to load default BIOS values, optimal failsafe values and to save configuration changes.

```
Aptio Setup Utility - Copyright (C) 2015 American Megatrends, Inc.
Main   Advanced  Chipset  Security  Boot   Save & Exit
Save Changes and Reset
Discard Changes and Reset

Restore Defaults
Save as User Defaults
Restore User Defaults

Reset the system after
saving the changes.

-----
-><: Select Screen
↑↓: Select Item
Enter: Select
+/-: Change Opt.
F1: General Help
F2: Previous Values
F3: Optimized Defaults
F4: Save & Exit
ESC: Exit

Version 2.17.1245. Copyright (C) 2015 American Megatrends, Inc.
```

### BIOS Menu 19: Save & Exit

#### → Save Changes and Reset

Use the **Save Changes and Reset** option to save the changes made to the BIOS options and reset the system.

#### → Discard Changes and Reset

Use the **Discard Changes and Reset** option to exit the system without saving the changes made to the BIOS configuration setup program.

#### → Restore Defaults

Use the **Restore Defaults** option to load the optimal default values for each of the parameters on the Setup menus. **F3 key can be used for this operation.**

#### → Save as User Defaults

Use the **Save as User Defaults** option to save the changes done so far as user defaults.



## IKARPC-07A-BT In-vehicle Panel PC

### → Restore User Defaults

Use the **Restore User Defaults** option to restore the user defaults to all the setup options.

Chapter

**6**

# Interface Connectors

---

## IKARPC-07A-BT In-vehicle Panel PC

### 6.1 Peripheral Interface Connectors

The motherboard of the IKARPC-07A-BT comes with a number of peripheral interface connectors and configuration jumpers. The connector locations are shown in **Figure 6-1** and **Figure 6-2**. The Pin 1 locations of the on-board connectors are also indicated in the diagrams below. The connector pinouts for these connectors are listed in the following sections.

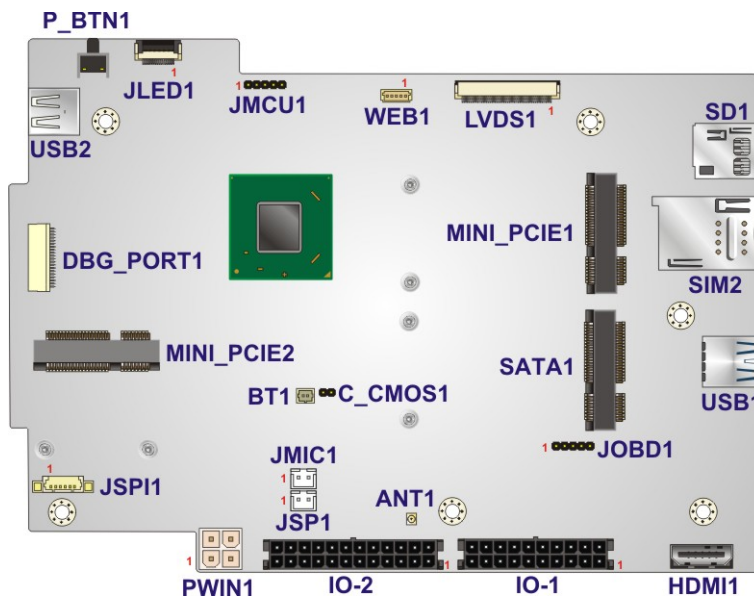

Figure 6-1: Main Board Layout Diagram (Front Side)

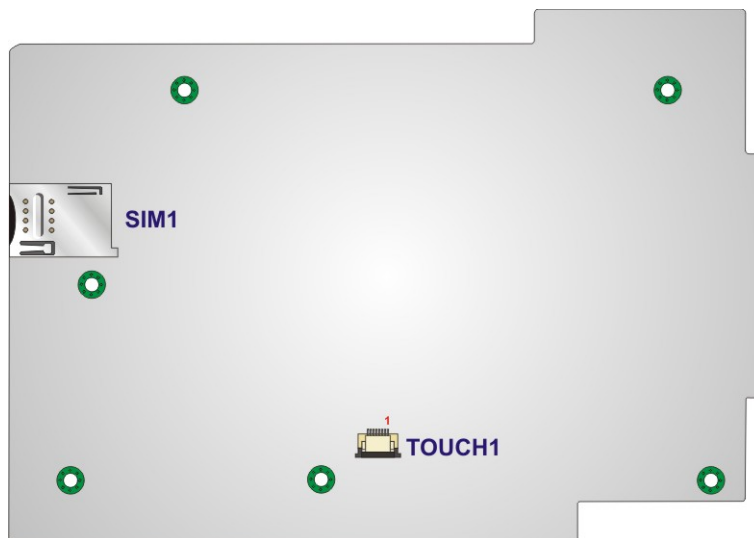

Figure 6-2: Main Board Layout Diagram (Solder Side)

## 6.2 Internal Peripheral Connectors

Internal peripheral connectors are found on the motherboard and are only accessible when the motherboard is outside of the chassis. The table below shows a list of the peripheral interface connectors on the IKARPC-07A-BT motherboard. Pinouts of these connectors can be found in the following sections.

Connector	Type	Label
Battery connector	2-pin wafer	BT1
Camera connector	5-pin wafer	WEB1
Clear CMOS connector	2-pin header	C_CMOS1
Debug port connector	12-pin wafer	DBG_PORT1
GPS antenna connector	Antenna connector	ANT1
LED connector	12-pin FPC	JLED1
LVDS connector	40-pin FPC	LVDS1
Microphone connector	2-pin wafer	JMIC1
mSATA module socket	Full-size PCIe Mini	SATA1
PCIe Mini socket for 3.75G module	Full-size PCIe Mini	MINI_PCIE1
PCIe Mini socket for wireless module	Half-size PCIe Mini	MINI_PCIE2
Power button	Push button	P_BTN1
Programming connector	5-pin header	JMCU1 JOB1
Speaker connector	2-pin wafer	JSP1
SPI flash connector	6-pin wafer	JSPI1
Touch panel connector	8-pin FPC	TOUCH1

**Table 6-1: Peripheral Interface Connectors**

## IKARPC-07A-BT In-vehicle Panel PC

### 6.2.1 Battery Connector (BT1)

PIN NO.	DESCRIPTION
1	VBATT
2	GND

**Table 6-2: Battery Connector (BT1) Pinouts**

### 6.2.2 Camera Connector (WEB1)

PIN NO.	DESCRIPTION
1	VCC
2	USB-
3	USB+
4	GND
5	GND

**Table 6-3: Camera Connector (WEB1) Pinouts**

### 6.2.3 Clear CMOS Connector (C\_CMOS1)

PIN NO.	DESCRIPTION
1	RTC_RST#
2	GND

**Table 6-4: Clear CMOS Connector (C\_CMOS1) Pinouts**

### 6.2.4 LED Connector (JLED1)

PIN NO.	DESCRIPTION
1	VCC3
2	VCC3
3	PWR_LED_ON
4	PWR_LED_OFF
5	AUTODIMMING_DATA
6	AUTODIMMING_CLK
7	3.5G_LED



8	3.5G_LEDB
9	WIFI_LED
10	HDD_LED
11	GND
12	GND

**Table 6-5: LED Connector (JLED1) Pinouts**

### 6.2.5 LVDS Connector (LVDS1)

PIN NO.	DESCRIPTION	PIN NO.	DESCRIPTION
1	VLCD_VCOM	21	LCM_RIN3+
2	VLCD_VDD	22	GND
3	LCD_AVDD	23	NC
4	NC	24	NC
5	RST	25	GND
6	LCD_AVDD	26	NC
7	GND	27	NC
8	LCM_RIN0-	28	GND
9	LCM_RIN0+	29	VCC_LCD_AVDD
10	GND	30	GND
11	LCM_RIN1-	31	LCM_LEDK
12	LCM_RIN1+	32	LCM_LEDK
13	GND	33	LCD_AVDD
14	LCM_RIN2-	34	GND
15	LCM_RIN2+	35	VLCD_VGL
16	GND	36	GND
17	LCM_CLK-	37	GND
18	LCM_CLK+	38	VLCD_VGH
19	GND	39	LCM_LEDA
20	LCM_RIN3-	40	LCM_LEDA

**Table 6-6: LVDS Connector (LVDS1) Pinouts**

## IKARPC-07A-BT In-vehicle Panel PC

### 6.2.6 Microphone Connector (JM1C1)

PIN NO.	DESCRIPTION
1	JMIC
2	GND

**Table 6-7: Microphone Connector (JM1C1) Pinouts**

### 6.2.7 mSATA Module Socket (SATA1)

PIN NO.	DESCRIPTION	PIN NO.	DESCRIPTION
1	NC	2	VCC3
3	NC	4	GND
5	NC	6	NC
7	NC	8	NC
9	GND	10	NC
11	NC	12	NC
13	NC	14	NC
15	GND	16	NC
17	NC	18	GND
19	NC	20	NC
21	GND	22	NC
23	TPC_SATO_RXP_C	24	VCC3
25	TPC_SATO_RXN_C	26	GND
27	GND	28	NC
29	GND	30	NC
31	TPC_SATO_TXN_C	32	NC
33	TPC_SATO_TXP_C	34	GND
35	GND	36	NC
37	GND	38	NC
39	VCC3	40	GND
41	VCC3	42	NC
43	NC	44	NC
45	NC	46	NC

PIN NO.	DESCRIPTION	PIN NO.	DESCRIPTION
47	NC	48	NC
49	NC	50	GND
51	NC	52	VCC3

**Table 6-8: mSATA Module Socket (SATA1) Pinouts**

### 6.2.8 PCIe Mini Socket for 3.75G Module (MINI\_PCIE1)

This socket supports USB interface only and voice function.

PIN NO.	DESCRIPTION	PIN NO.	DESCRIPTION
1	NC	2	VCC3
3	NC	4	GND
5	NC	6	VCC1.5
7	NC	8	SIM_VCC
9	GND	10	SIM_CIO
11	NC	12	SIM_CLK
13	NC	14	SIM_RST
15	GND	16	NC
17	NC	18	GND
19	NC	20	NC
21	GND	22	NC
23	NC	24	VCC3
25	NC	26	GND
27	GND	28	VCC1.5
29	GND	30	NC
31	NC	32	SMS_RING
33	NC	34	GND
35	GND	36	USB_DATA_N
37	GND	38	USB_DATA_P
39	VCC3	40	GND
41	VCC3	42	NC
43	3GLED_EN	44	NC
45	NC	46	NC

## IKARPC-07A-BT In-vehicle Panel PC

PIN NO.	DESCRIPTION	PIN NO.	DESCRIPTION
47	NC	48	VCC1.5
49	NC	50	GND
51	NC	52	VCC3

**Table 6-9: PCIe Mini Socket for 3.75G Module (MINI\_PCIE1) Pinouts**

### 6.2.9 PCIe Mini Socket for Wireless Module (MINI\_PCIE2)

This socket supports USB interface and PCIe interface.

PIN NO.	DESCRIPTION	PIN NO.	DESCRIPTION
1	WAKE#	2	VCC3
3	NC	4	GND
5	NC	6	VCC1.5
7	NC	8	NC
9	GND	10	NC
11	CLK_PCIE_CLK_N	12	NC
13	CLK_PCIE_CLK_P	14	NC
15	GND	16	NC
17	NC	18	GND
19	NC	20	GPIO_WIFI
21	WIFI_LED1	22	PCIRST#
23	PCIE_RXN	24	VCC3
25	PCIE_RXP	26	GND
27	GND	28	VCC1.5
29	GND	30	SMB_CLK
31	PCIE_TXN	32	SMB_DATA
33	PCIE_TXP	34	GND
35	GND	36	USB_DATA_N
37	NC	38	USB_DATA_P
39	NC	40	GND
41	NC	42	WIFI_LED3
43	NC	44	WIFI_LED2
45	NC	46	NC

PIN NO.	DESCRIPTION	PIN NO.	DESCRIPTION
47	NC	48	VCC1.5
49	NC	50	GND
51	NC	52	VCC3

**Table 6-10: PCIe Mini Socket for Wireless Module (MINI\_PCIE2) Pinouts**

### 6.2.10 Programming Connector (JMCU1)

PIN NO.	DESCRIPTION
1	MCLR
2	VCC5
3	GND
4	ICSP_CLK
5	ICSP_DAT

**Table 6-11: Programming Connector (JMCU1) Pinouts**

### 6.2.11 Programming Connector (JOB1)

PIN NO.	DESCRIPTION
1	MCLR
2	VCC5
3	GND
4	ICSP_CLK
5	ICSP_DAT

**Table 6-12: Programming Connector (JOB1) Pinouts**

### 6.2.12 Speaker Connector (JSP1)

PIN NO.	DESCRIPTION
1	SPK_OUT_P_L
2	SPK_OUT_N_L

**Table 6-13: Speaker Connector (JSP1) Pinouts**



## IKARPC-07A-BT In-vehicle Panel PC

### 6.2.13 SPI Flash Connector (JSPI1)

PIN NO.	DESCRIPTION
1	VCC3
2	CS
3	MISO
4	CLK
5	MOSI
6	GND

**Table 6-14: SPI Flash Connector (JSPI1) Pinouts**

### 6.2.14 Touch Panel Connector (TOUCH1)

PIN NO.	DESCRIPTION
1	VCC3
2	GND
3	USB-
4	USB+
5	NC
6	NC
7	NC
8	NC

**Table 6-15: Touch Panel Connector (TOUCH1) Pinouts**

### 6.3 External Peripheral Connectors

The table below shows a list of the external peripheral interface connectors on the IKARPC-07A-BT motherboard. Pinouts of these connectors can be found in **Section 3.6**.

Connector	Type	Label
OBD-II, LAN and USB connector	20-pin connector	IO-1
RS-232, DIO and audio connector	24-pin connector	IO-2
HDMI connector	HDMI connector	HDMI1
microSD card socket	microSD card socket	SD1
Power input connector	4-pin Molex	PWIN1
SIM card socket	SIM card socket	SIM1, SIM2
USB 2.0 port	External USB 2.0	USB2
USB 3.0 port	External USB 3.0	USB1

**Table 6-16: Peripheral Interface Connectors**

**Appendix**

**A**

# **Regulatory Compliance**

---

**DECLARATION OF CONFORMITY**

This equipment is in conformity with the following EU directives:

- EMC Directive (2004/108/EC, 2014/30/EU)
- Low-Voltage Directive (2006/95/EC, 2014/35/EU)
- RoHS II Directive (2011/65/EU, 2015/863/EU)

If the user modifies and/or install other devices in the equipment, the CE conformity declaration may no longer apply.

If this equipment has telecommunications functionality, it also complies with the requirements of the Radio Equipment Directive 2014/53/EU.

---

English

IEI Integration Corp declares that this equipment is in compliance with the essential requirements and other relevant provisions of Directive 2014/53/EU.

---

Български [Bulgarian]

IEI Integration Corp. декларира, че този оборудване е в съответствие със съществените изисквания и другите приложими правила на Директива 2014/53/EU.

---

Česky [Czech]

IEI Integration Corp tímto prohlašuje, že tento zařizení je ve shodě se základními požadavky a dalšími příslušnými ustanoveními směrnice 2014/53/EU.

---

Dansk [Danish]

IEI Integration Corp erklærer herved, at følgende udstyr overholder de væsentlige krav og øvrige relevante krav i direktiv 2014/53/EU.

---

Deutsch [German]

IEI Integration Corp, erklärt dieses Gerät entspricht den grundlegenden Anforderungen und den weiteren entsprechenden Vorgaben der Richtlinie 2014/53/EU.

---

Eesti [Estonian]

IEI Integration Corp deklareerib seadme seadme vastavust direktiivi 2014/53/EÜ põhinõuetele ja nimetatud direktiivist tulenevatele teistele asjakohastele sätetele.

---

**IKARPC-07A-BT In-vehicle Panel PC**

---

**Español [Spanish]**

IEI Integration Corp declara que el equipo cumple con los requisitos esenciales y cualesquiera otras disposiciones aplicables o exigibles de la Directiva 2014/53/EU.

---

**Ελληνική [Greek]**

IEI Integration Corp ΔΗΛΩΝΕΙ ΟΤΙ ΕΞΟΠΛΙΣΜΟΣ ΣΥΜΜΟΡΦΩΝΕΤΑΙ ΠΡΟΣ ΤΙΣ ΟΥΣΙΩΔΕΙΣ ΑΠΑΙΤΗΣΕΙΣ ΚΑΙ ΤΙΣ ΛΟΙΠΕΣ ΣΧΕΤΙΚΕΣ ΔΙΑΤΑΞΕΙΣ ΤΗΣ ΟΔΗΓΙΑΣ 2014/53/EU.

---

**Français [French]**

IEI Integration Corp déclare que l'appareil est conforme aux exigences essentielles et aux autres dispositions pertinentes de la directive 2014/53/EU.

---

**Italiano [Italian]**

IEI Integration Corp dichiara che questo apparecchio è conforme ai requisiti essenziali ed alle altre disposizioni pertinenti stabilite dalla direttiva 2014/53/EU.

---

**Latviski [Latvian]**

IEI Integration Corp deklarē, ka iekārta atbilst būtiskajām prasībām un citiem ar to saistītajiem noteikumiem Direktīvas 2014/53/EU.

---

**Lietuvių [Lithuanian]**

IEI Integration Corp deklaruoja, kad šis įranga atitinka esminius reikalavimus ir kitas 2014/53/EU Direktyvos nuostatas.

---

**Nederlands [Dutch]**

IEI Integration Corp dat het toestel toestel in overeenstemming is met de essentiële eisen en de andere relevante bepalingen van richtlijn 2014/53/EU.

---

**Malti [Maltese]**

IEI Integration Corp jiddikjara li dan prodott jikkonforma mal-ħtiġijiet essenzjali u ma provvedimenti oħrajn relevanti li hemm fid-Dirrettiva 2014/53/EU.

---

**Magyar [Hungarian]**

IEI Integration Corp nyilatkozom, hogy a berendezés megfelel a vonatkozó alapvető követelményeknek és az 2014/53/EU irányelv egyéb előírásainak.

---

**Polski [Polish]**

IEI Integration Corp oświadcza, że wyrobu jest zgodny z zasadniczymi wymogami oraz pozostałymi stosownymi postanowieniami Dyrektywy 2014/53/EU.

---

**Português [Portuguese]**

IEI Integration Corp declara que este equipamento está conforme com os requisitos essenciais e outras disposições da Directiva 2014/53/EU.

---



---

Româna [Romanian]

IEI Integration Corp declară că acest echipament este în conformitate cu cerințele esențiale și cu celelalte prevederi relevante ale Directivei 2014/53/EU.

---

Slovensko [Slovenian]

IEI Integration Corp izjavlja, da je ta opreme v skladu z bistvenimi zahtevami in ostalimi relevantnimi določili direktive 2014/53/EU.

---

Slovensky [Slovak]

IEI Integration Corp týmto vyhlasuje, že zariadenia spĺňa základné požiadavky a všetky príslušné ustanovenia Smernice 2014/53/EU.

---

Suomi [Finnish]

IEI Integration Corp vakuuttaa täten että laitteet on direktiivin 2014/53/EU oleellisten vaatimusten ja sitä koskevien direktiivin muiden ehtojen mukainen.

---

Svenska [Swedish]

IEI Integration Corp förklarar att denna utrustningstyp står i överensstämmelse med de väsentliga egenskapskrav och övriga relevanta bestämmelser som framgår av direktiv 2014/53/EU.

---

## IKARPC-07A-BT In-vehicle Panel PC

### FCC WARNING



This equipment complies with Part 15 of the FCC Rules. Operation is subject to the following two conditions:

- This device may not cause harmful interference, and
- This device must accept any interference received, including interference that may cause undesired operation.

This equipment has been tested and found to comply with the limits for a Class A digital device, pursuant to part 15 of the FCC Rules. These limits are designed to provide reasonable protection against harmful interference when the equipment is operated in a commercial environment. This equipment generates, uses, and can radiate radio frequency energy and, if not installed and used in accordance with the instruction manual, may cause harmful interference to radio communications. Operation of this equipment in a residential area is likely to cause harmful interference in which case the user will be required to correct the interference at his own expense.

#### **Federal Communication Commission Interference Statement**

This equipment has been assembled with components that comply with the limits for a Class B digital device, pursuant to Part 15 of the FCC Rules. These limits are designed to provide reasonable protection against harmful interference in a residential installation. This equipment generates, uses and can radiate radio frequency energy and, if not installed and used in accordance with the instructions, may cause harmful interference to radio communications. However, there is no guarantee that interference will not occur in a particular installation. If this equipment does cause harmful interference to radio or television reception, which can be determined by turning the equipment off and on, the user is encouraged to try to correct the interference by one of the following measures:

- Reorient or relocate the receiving antenna.
- Increase the separation between the equipment and receiver.
- Connect the equipment into an outlet on a circuit different from that to which the receiver is connected.
- Consult the dealer or an experienced radio/TV technician for help.

Appendix

**B**

# Safety Precautions

---

**WARNING:**

The precautions outlined in this chapter should be strictly followed. Failure to follow these precautions may result in permanent damage to the IKARPC-07A-BT.

## B.1 Safety Precautions

Please follow the safety precautions outlined in the sections that follow:

### B.1.1 General Safety Precautions

Please ensure the following safety precautions are adhered to at all times.

- **Follow the electrostatic precautions** outlined below whenever the device is opened.
- **Make sure the power is turned off and the power cord is disconnected** whenever the IKARPC-07A-BT is being installed, moved or modified.
- **To prevent the risk of electric shock, make sure power cord is unplugged from wall socket.** To fully disengage the power to the unit, please disconnect the power cord from the power outlet. Refer servicing to qualified service personnel. The power outlet shall be readily available and accessible.
- **Do not apply voltage levels that exceed the specified voltage range.** Doing so may cause fire and/or an electrical shock. Use a power cord that matches the voltage of the power outlet, which has been approved and complies with the safety standard of your particular country.
- **Electric shocks can occur** if the IKARPC-07A-BT chassis is opened when it is running. To avoid risk of electric shock, this device must only be connected to a supply mains with protective earth.
- **Do not drop or insert any objects** into the ventilation openings of the IKARPC-07A-BT.

- **If considerable amounts of dust, water, or fluids enter the device**, turn off the power supply immediately, unplug the power cord, and contact the IKARPC-07A-BT vendor.
- **DO NOT:**
  - Drop the device against a hard surface.
  - Strike or exert excessive force onto the LCD panel.
  - Touch any of the LCD panels with a sharp object
  - In a site where the ambient temperature exceeds the rated temperature

### B.1.2 Anti-static Precautions

---



#### **WARNING:**

Failure to take ESD precautions during the installation of the IKARPC-07A-BT may result in permanent damage to the IKARPC-07A-BT and severe injury to the user.

---

Electrostatic discharge (ESD) can cause serious damage to electronic components, including the IKARPC-07A-BT. Dry climates are especially susceptible to ESD. It is therefore critical that whenever the IKARPC-07A-BT is opened and any of the electrical components are handled, the following anti-static precautions are strictly adhered to.

- **Wear an anti-static wristband:** Wearing a simple anti-static wristband can help to prevent ESD from damaging any electrical component.
- **Self-grounding:** Before handling any electrical component, touch any grounded conducting material. During the time the electrical component is handled, frequently touch any conducting materials that are connected to the ground.
- **Use an anti-static pad:** When configuring or working with an electrical component, place it on an anti-static pad. This reduces the possibility of ESD damage.
- **Only handle the edges of the electrical component:** When handling the electrical component, hold the electrical component by its edges.



## IKARPC-07A-BT In-vehicle Panel PC

### B.1.3 Product Disposal

---



#### CAUTION:

Risk of explosion if battery is replaced by an incorrect type. Only certified engineers should replace the on-board battery.

Dispose of used batteries according to instructions and local regulations.

---

- Outside the European Union – If you wish to dispose of used electrical and electronic products outside the European Union, please contact your local authority so as to comply with the correct disposal method.
- Within the European Union – The device that produces less waste and is easier to recycle is classified as electronic device in terms of the European Directive 2012/19/EU (WEEE), and must not be disposed of as domestic garbage.

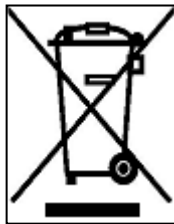

EU-wide legislation, as implemented in each Member State, requires that waste electrical and electronic products carrying the mark (left) must be disposed of separately from normal household waste. This includes monitors and electrical accessories, such as signal cables or power cords. When you need to dispose of your display products, please follow the guidance of your local authority, or ask the shop where you purchased the product. The mark on electrical and electronic products only applies to the current European Union Member States.

Please follow the national guidelines for electrical and electronic product disposal.

## B.2 Maintenance and Cleaning Precautions

When maintaining or cleaning the IKARPC-07A-BT, please follow the guidelines below.



### WARNING:

- For safety reasons, turn-off the power and unplug the panel PC before cleaning.
  - If you dropped any material or liquid such as water onto the panel PC when cleaning, unplug the power cable immediately and contact your dealer or the nearest service center. Always make sure your hands are dry when unplugging the power cable.
- 

### B.2.1 Maintenance and Cleaning

Prior to cleaning any part or component of the IKARPC-07A-BT, please read the details below.

- Except for the LCD panel, never spray or squirt liquids directly onto any other components. To clean the LCD panel, gently wipe it with a piece of soft dry cloth or a slightly moistened cloth.
- The interior of the device does not require cleaning. Keep fluids away from the device interior.
- Be cautious of all small removable components when vacuuming the device.
- Never drop any objects or liquids through the openings of the device.
- Be cautious of any possible allergic reactions to solvents or chemicals used when cleaning the device.
- Avoid eating, drinking and smoking within vicinity of the device.

### B.2.2 Cleaning Tools

Some components in the IKARPC-07A-BT may only be cleaned using a product specifically designed for the purpose. In such case, the product will be explicitly mentioned in the cleaning tips. Below is a list of items to use when cleaning the IKARPC-07A-BT.

- **Cloth** – Although paper towels or tissues can be used, a soft, clean piece of cloth is recommended when cleaning the device.

## IKARPC-07A-BT In-vehicle Panel PC

- **Water or rubbing alcohol** – A cloth moistened with water or rubbing alcohol can be used to clean the device.
- **Using solvents** – The use of solvents is not recommended when cleaning the device as they may damage the plastic parts.
- **Vacuum cleaner** – Using a vacuum specifically designed for computers is one of the best methods of cleaning the device. Dust and dirt can restrict the airflow in the device and cause its circuitry to corrode.
- **Cotton swabs** – Cotton swabs moistened with rubbing alcohol or water are excellent tools for wiping hard to reach areas.
- **Foam swabs** – Whenever possible, it is best to use lint free swabs such as foam swabs for cleaning.

Appendix

**C**

# Watchdog Timer

---

## IKARPC-07A-BT In-vehicle Panel PC



### NOTE:

The following discussion applies to DOS. Contact IEI support or visit the IEI website for drivers for other operating systems.

The Watchdog Timer is a hardware-based timer that attempts to restart the system when it stops working. The system may stop working because of external EMI or software bugs. The Watchdog Timer ensures that standalone systems like ATMs will automatically attempt to restart in the case of system problems.

A BIOS function call (INT 15H) is used to control the Watchdog Timer.

INT 15H:

AH – 6FH Sub-function:	
AL – 2:	Sets the Watchdog Timer's period.
BL:	Time-out value (Its unit-second is dependent on the item "Watchdog Timer unit select" in CMOS setup).

**Table C-1: AH-6FH Sub-function**

Call sub-function 2 to set the time-out period of Watchdog Timer first. If the time-out value is not zero, the Watchdog Timer starts counting down. When the timer value reaches zero, the system resets. To ensure that this reset condition does not occur, calling sub-function 2 must periodically refresh the Watchdog Timer. However, the watchdog timer is disabled if the time-out value is set to zero.

A tolerance of at least 10% must be maintained to avoid unknown routines within the operating system (DOS), such as disk I/O that can be very time-consuming.



**NOTE:**

The Watchdog Timer is activated through software. The software application that activates the Watchdog Timer must also deactivate it when closed. If the Watchdog Timer is not deactivated, the system will automatically restart after the Timer has finished its countdown.

**EXAMPLE PROGRAM:**

```
; INITIAL TIMER PERIOD COUNTER
```

```
;
```

```
W_LOOP:
```

```
;
```

```
MOV     AX, 6F02H    ;setting the time-out value  
MOV     BL, 30      ;time-out value is 48 seconds  
INT     15H
```

```
;
```

```
; ADD THE APPLICATION PROGRAM HERE
```

```
;
```

```
CMP     EXIT_AP, 1  ;is the application over?  
JNE     W_LOOP     ;No, restart the application
```

```
MOV     AX, 6F02H  ;disable Watchdog Timer  
MOV     BL, 0;  
INT     15H
```

```
;
```

```
; EXIT ;
```

Appendix

**D**

# **Hazardous Materials Disclosure**

---

The details provided in this appendix are to ensure that the product is compliant with the Peoples Republic of China (China) RoHS standards. The table below acknowledges the presences of small quantities of certain materials in the product, and is applicable to China RoHS only.

A label will be placed on each product to indicate the estimated “Environmentally Friendly Use Period” (EFUP). This is an estimate of the number of years that these substances would “not leak out or undergo abrupt change.” This product may contain replaceable sub-assemblies/components which have a shorter EFUP such as batteries and lamps. These components will be separately marked.

Please refer to the following table.

Part Name	Toxic or Hazardous Substances and Elements					
	Lead (Pb)	Mercury (Hg)	Cadmium (Cd)	Hexavalent Chromium (CR(VI))	Polybrominated Biphenyls (PBB)	Polybrominated Diphenyl Ethers (PBDE)
Housing	O	O	O	O	O	O
Display	O	O	O	O	O	O
Printed Circuit Board	O	O	O	O	O	O
Metal Fasteners	O	O	O	O	O	O
Cable Assembly	O	O	O	O	O	O
Fan Assembly	O	O	O	O	O	O
Power Supply Assemblies	O	O	O	O	O	O
Battery	O	O	O	O	O	O

O: This toxic or hazardous substance is contained in all of the homogeneous materials for the part is below the limit requirement in SJ/T11363-2006 (now replaced by GB/T 26572-2011).

X: This toxic or hazardous substance is contained in at least one of the homogeneous materials for this part is above the limit requirement in SJ/T11363-2006 (now replaced by GB/T 26572-2011).

## IKARPC-07A-BT In-vehicle Panel PC

此附件旨在确保本产品符合中国 RoHS 标准。以下表格标示此产品中某有毒物质的含量符合中国 RoHS 标准规定的限量要求。

本产品上会附有“环境友好使用期限”的标签，此期限是估算这些物质“不会有泄漏或突变”的年限。本产品可能包含有较短的环境友好使用期限的可替换元件，像是电池或灯管，这些元件将会单独标示出来。

部件名称	有毒有害物质或元素					
	铅 (Pb)	汞 (Hg)	镉 (Cd)	六价铬 (CR(VI))	多溴联苯 (PBB)	多溴二苯 醚 (PBDE)
壳体	O	O	O	O	O	O
显示	O	O	O	O	O	O
印刷电路板	O	O	O	O	O	O
金属螺帽	O	O	O	O	O	O
电缆组装	O	O	O	O	O	O
风扇组装	O	O	O	O	O	O
电力供应组装	O	O	O	O	O	O
电池	O	O	O	O	O	O

O: 表示该有毒有害物质在该部件所有物质材料中的含量均在 SJ/T 11363-2006 (现由 GB/T 26572-2011 取代) 标准规定的限量要求以下。

X: 表示该有毒有害物质至少在该部件的某一均质材料中的含量超出 SJ/T 11363-2006 (现由 GB/T 26572-2011 取代) 标准规定的限量要求。