

# PPC2-C19-EHL

## IEI Heavy Industrial Panel PC

Powered by Intel® Elkhart Lake Platform



[www.ieiworld.com](http://www.ieiworld.com)



# PPC2-C19-EHL

Panel PC equips Intel® Celeron® J6412 processor, on-board 8GB memory, HDMI display output, dual 2.5G Ethernet port, one M.2 M key & one M.2 B Key & one M.2 A key expansion slots, 12~24V DC input, anti-glare and anti-UV 10-point touchscreen

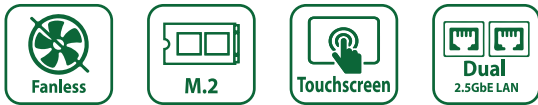

## IP2EHL\_XC Expansion Interface

The IP2EHL\_XC connector allows users to flexibly expand functionality such as network, serial ports and CAN to meet various application requirements. (IEI-designed pin definition, supported functions are customized, for models of 10-inch or above)

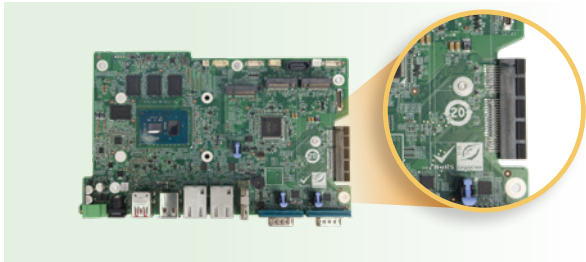

## M.2 B Key & M.2 M Key

Dual M.2 ultra-high-speed expansion supporting SSD & AI accelerator to enhance efficiency

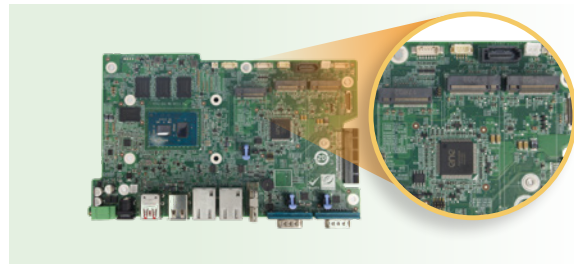

## Anti-glare and Anti-UV PCAP

With anti-glare and anti-UV coating, the 10-point touchscreen can display clearly without reflection for a long time use in outdoors and bright light environment.



## Support Gloved and Wet Hand Operation

The whole new PCAP screen allows you to accurately manage every step of your operations even with gloves or in wet conditions.



## Newly Designed Panel Mount Kit

The new refined and convenient panel mount kit can be easily fastened by hand, no screwdriver required.



## New Graphical BIOS Interface

The whole new PCAP screen allows you to accurately manage every step of your operations even with gloves or in wet conditions.

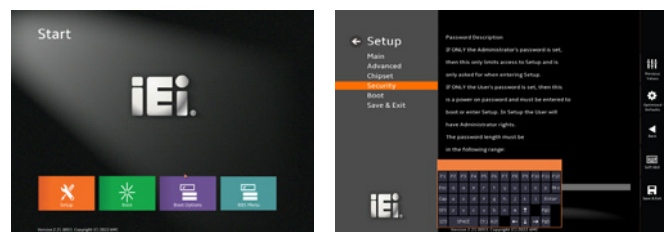

## Fully Integrated I/O

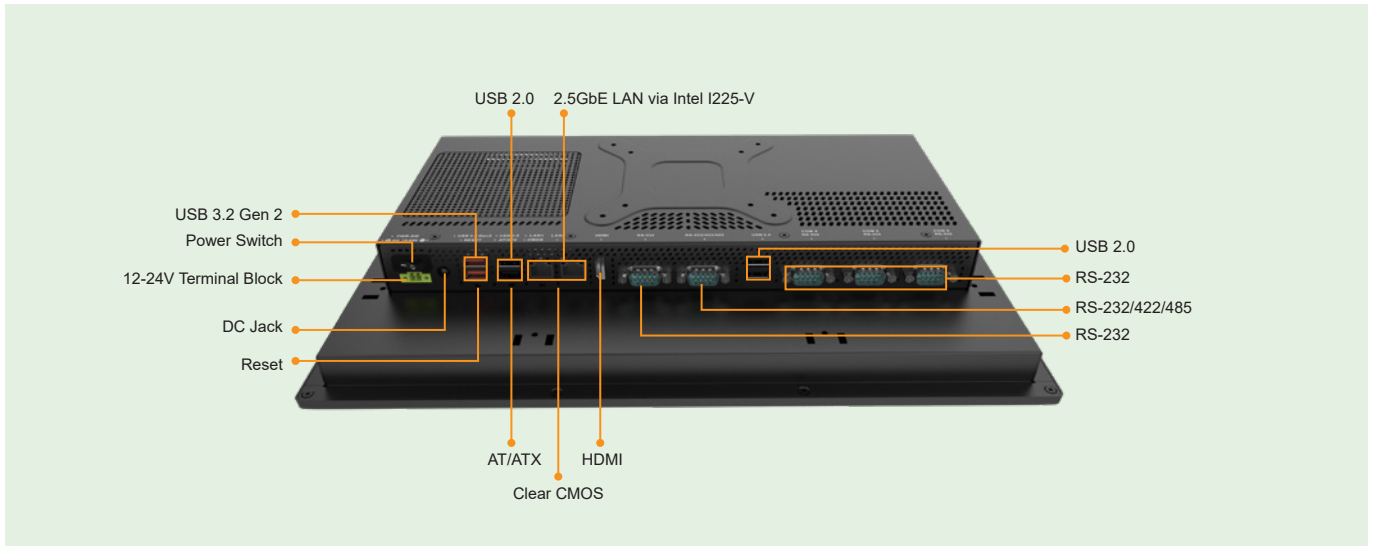

## Block Diagram

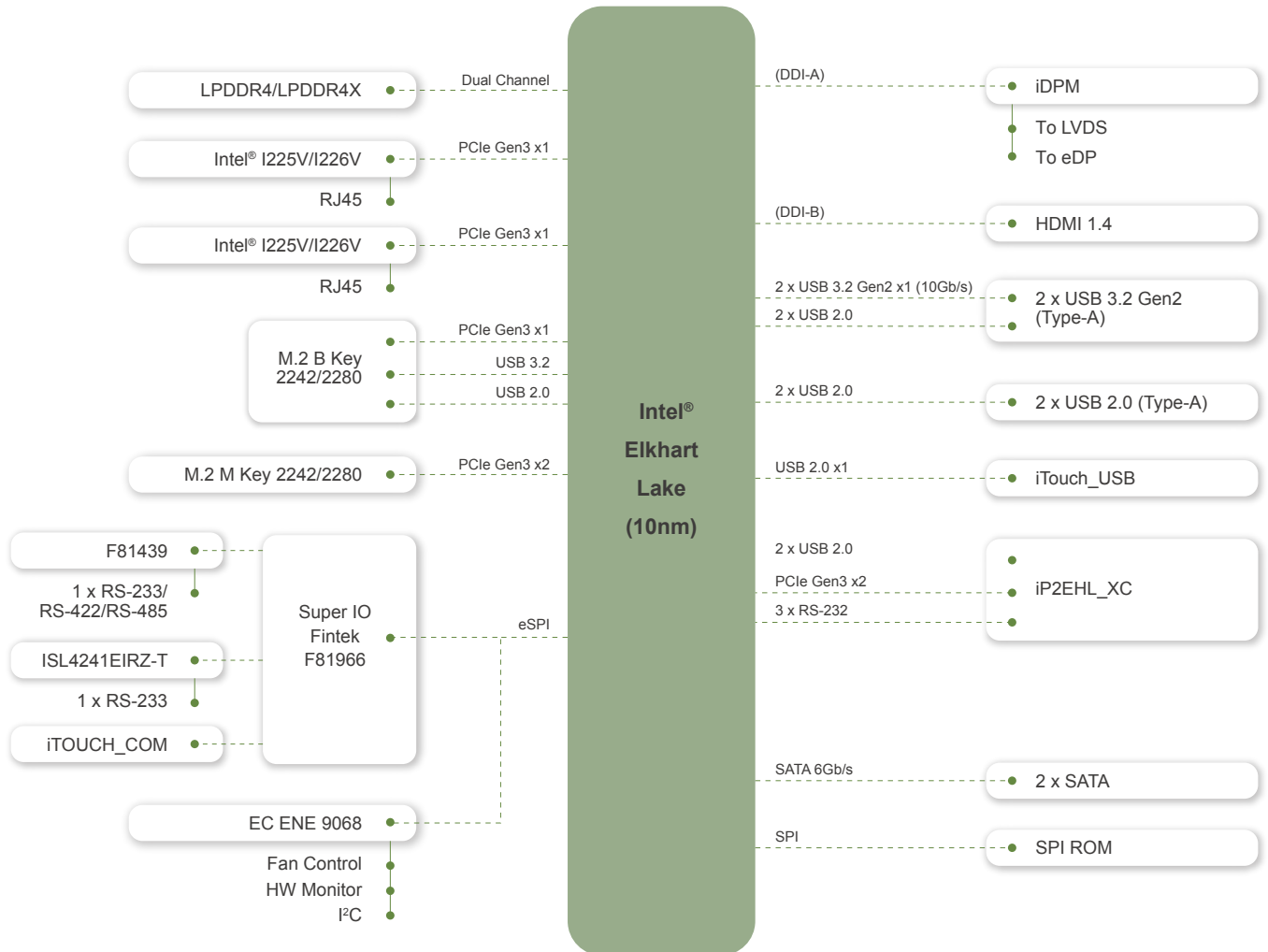

## Dimensions (Unit: mm)

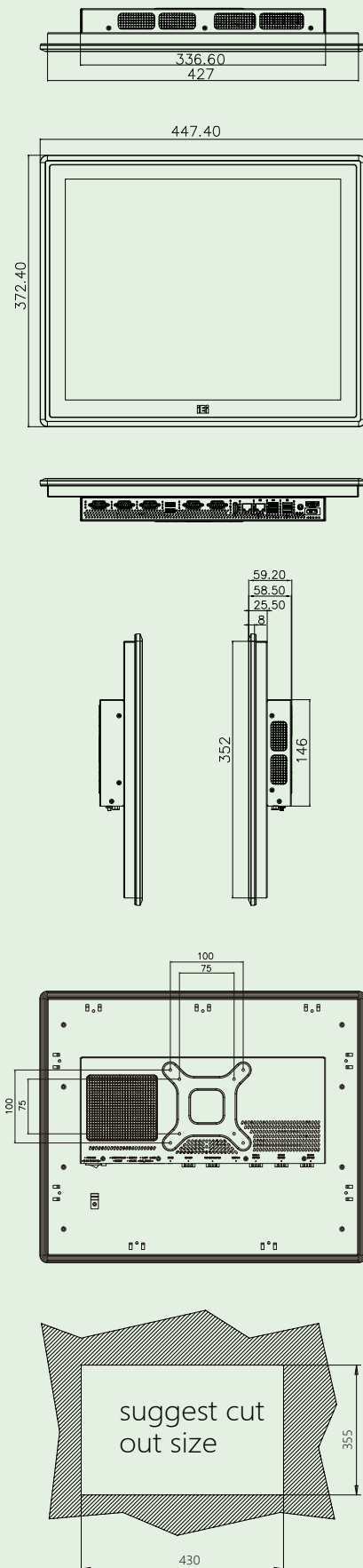

## Specifications

PPC2-C19-EHL																			
LCD Display	19" (5:4)																		
Resolution	1280 (W) x 1024 (H)																		
Brightness	450 cd/cm <sup>2</sup>																		
Contrast Ratio	1000:1																		
LCD Color	16.7M																		
Pixel Pitch (mm)	0.294 x 0.294																		
Viewing Angle (H-V)	178°/178°																		
Backlight MTBF	50,000 hours																		
SBC Model	PPC2MB2-EHL-RC-R10+PPC2-XIO-04-R10																		
CPU (SoC)	Intel® Celeron® Processor J6412 1.5M Cache, up to 2.60 GHz / TDP 10w																		
Memory	8GB dual-channel on-board LPDDR4/LPDDR4X																		
Touchscreen	Multi-point projected capacitive type (anti-UV / anti-glare coating, support gloves) Surface hardness: ≥7H																		
Touch Controller	Projected capacitive type: EETI 80																		
Storage	1 x 2.5" HDD/SSD drive bay																		
Ethernet	2 x 2.5GbE LAN via Intel I225-V/Intel I226-V																		
Wireless & Bluetooth(optional)	IEEE 802.11 a/b/g/n/ax, Bluetooth V5.2 1																		
Expansion	1 x M.2 2242/2280 B key (PCIe Gen3 x1 + USB 3.0) 1 x M.2 2242 M key (PCIe Gen3 x2)																		
Mounting	VESA 75/100 Panel, Wall, Rack, Stand and Arm																		
Construction Material	Aluminum front cover and sheet metal rear cover																		
Enclosure Color	Black																		
I/O Ports, Switches and Buttons	<table border="0"> <tr> <td>1 x HDMI output</td> <td>1 x Power button</td> </tr> <tr> <td>2 x RJ-45 GbE</td> <td>1 x Reset button</td> </tr> <tr> <td>2 x USB 3.2 Gen 2x1 (10Gb/s)</td> <td>1 x Clear CMOS button</td> </tr> <tr> <td>2 x USB 2.0</td> <td>PPC2-XIO-04-R10:</td> </tr> <tr> <td>1 x RS-232/422/485</td> <td>2 x USB 2.0</td> </tr> <tr> <td>1 x RS-232</td> <td>3 x RS-232</td> </tr> <tr> <td>1 x 12V-24V power jack</td> <td>M.2 A Key 2230</td> </tr> <tr> <td>1 x Power terminal block (2-pin)</td> <td>(PCIe gen3 x 2 + USB2.0)</td> </tr> <tr> <td>1 x AT/ATX switch</td> <td></td> </tr> </table>	1 x HDMI output	1 x Power button	2 x RJ-45 GbE	1 x Reset button	2 x USB 3.2 Gen 2x1 (10Gb/s)	1 x Clear CMOS button	2 x USB 2.0	PPC2-XIO-04-R10:	1 x RS-232/422/485	2 x USB 2.0	1 x RS-232	3 x RS-232	1 x 12V-24V power jack	M.2 A Key 2230	1 x Power terminal block (2-pin)	(PCIe gen3 x 2 + USB2.0)	1 x AT/ATX switch	
1 x HDMI output	1 x Power button																		
2 x RJ-45 GbE	1 x Reset button																		
2 x USB 3.2 Gen 2x1 (10Gb/s)	1 x Clear CMOS button																		
2 x USB 2.0	PPC2-XIO-04-R10:																		
1 x RS-232/422/485	2 x USB 2.0																		
1 x RS-232	3 x RS-232																		
1 x 12V-24V power jack	M.2 A Key 2230																		
1 x Power terminal block (2-pin)	(PCIe gen3 x 2 + USB2.0)																		
1 x AT/ATX switch																			
Power Input	12 V ~ 24 V DC																		
Power Adapter	60W power adapter																		
Power Consumption	TBD																		
Thermal Solution	Fanless																		
TPM	Intel® Platform Trust Technology																		
Watchdog Timer	Software Programmable support 1~255 sec. system reset																		
Operating Temperature (with air flow)	-10°C ~ 50°C																		
Storage Temperature	-20°C ~ 60°C																		
Humidity	10% ~ 80%, non-condensing																		
IP Level	IP 65 compliant front panel																		
Safety and EMC	CE, FCC Class A																		
ErP	ErP 2009/125/EC																		
Dimensions (H x W x D) (mm)	447.40 x 372.40 x 59.20																		

## Packing List

1 x Power Cord	1 x Power Adapter	1 x QIG
1 x Panel Mount Kit	1 x Screw Pack (SATA)	

## Ordering Information

PPC2-C19-EHL-J1/8G-R11	19" 450 cd/cm <sup>2</sup> 1280x1024 Panel PC with Intel® Celeron® Processor 6412, 8GB LPDDR4x on-board, HDMI output, black, 12-24V DC input, projected capacitive touchscreen with AG, Powder paint, R11
------------------------	---

## Options

Item	Part No	Description
Arm	ARM-11-RS/ARM-31-RS	VESA 75/100 Desk ARM
Stand	STAND-C12-R10	VESA 75/100 Easy Stand
Wall Mount Kit	AFLWK-12/AFLWK-19B	Monitor Wall mounting kit
OS	WIN10-IOTE2019-V-RS	Win10 IoT Ent LTSC 2019 MultiLang OEI Value