

# PPC2-C170-ADLP

iEi Heavy Industrial Panel PC

Powered by Intel® Alder Lake-P



[www.ieiworld.com](http://www.ieiworld.com)



# PPC2-C170-ADLP

Fanless panel PC with narrow bezel design, Intel® Alder Lake-P platform, on-board 8GB memory, HDMI output, dual 2.5GbE LAN, two RS-232, two RS-232/422/485, five USB, two M.2 M key expansion slots, and anti-glare & anti-UV 10-point touchscreen



## 12th Gen Intel® Alder Lake-P Platform

Powered by 12th generation Intel® Alder Lake-P Series processors and asynchronous architecture, unleashing superior performance.

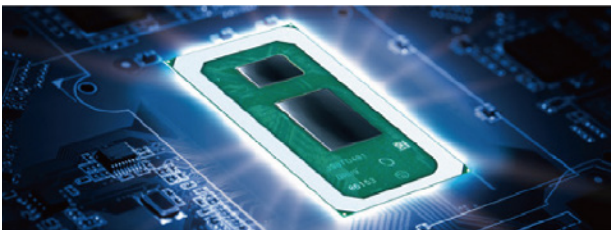

## Dual full-speed M.2 expansion slots

Two M.2 M keys support 2242 and 2280 size, PCIe Gen4 x 4 full speed signal, more bandwidth, faster speed.

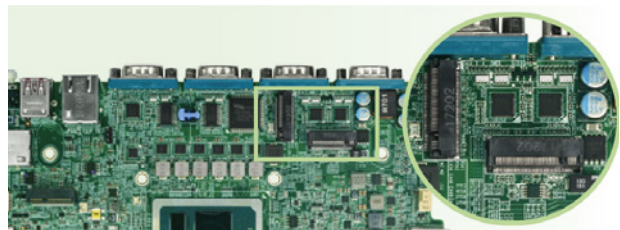

## Anti-glare and Anti-UV PCAP

With anti-glare and anti-UV coating, the 10-point touchscreen can display clearly without reflection.



## Works with Gloves and Water

The equipped capacitive touch screen supports gloved operation and waterproof function that can effectively eliminate false touch operating caused by water spray.



## Extensive I/O Interfaces

The panel PC is small, but comes with abundant I/O for a variety of application scenarios. It includes four UART, five USB, two 2.5G network port and one HDMI interface.



## IP65 rated front panel protection

With the IP65 front panel protection rating, this series is more durable and rugged, ensuring reliable operation in harsh industrial environments.



## Fully Integrated I/O

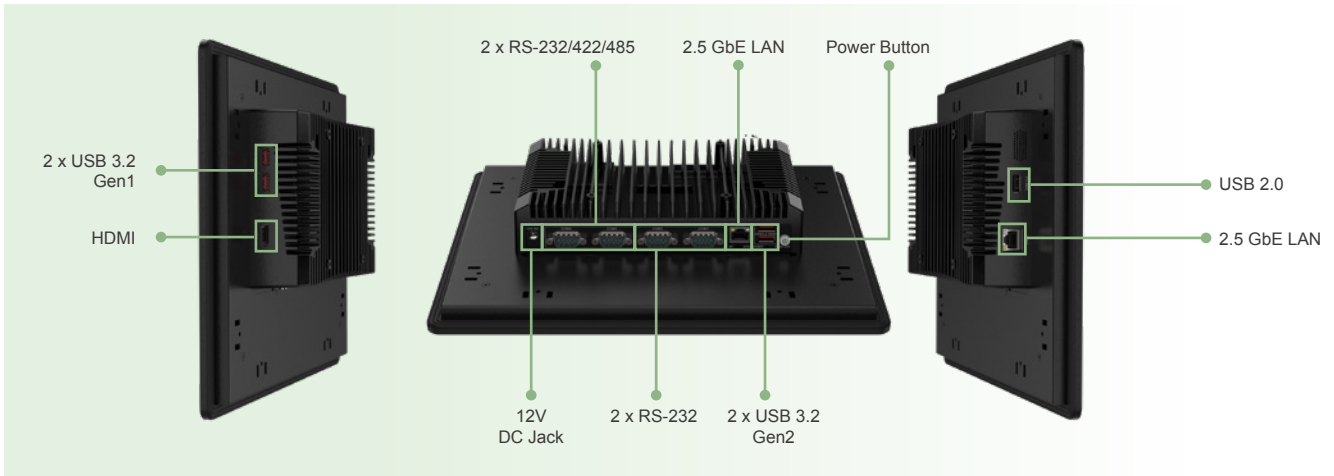

## Block Diagram

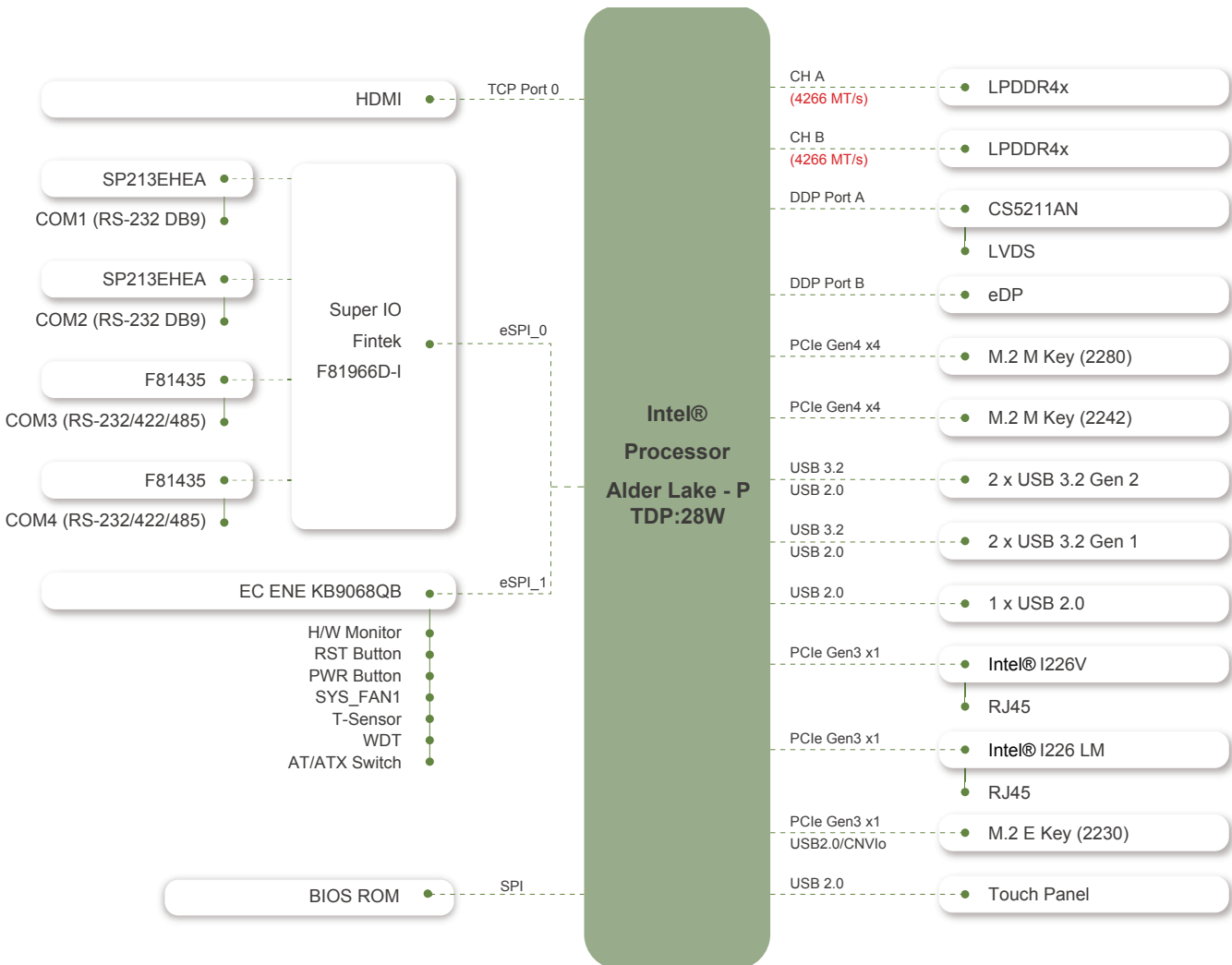

## Dimensions (Unit: mm)

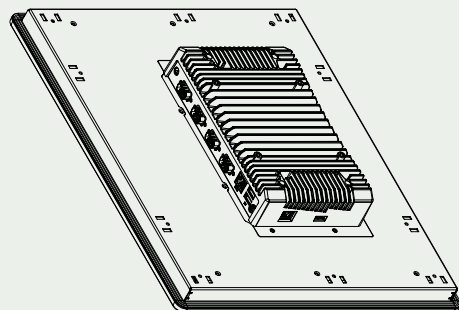
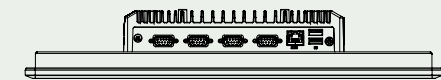
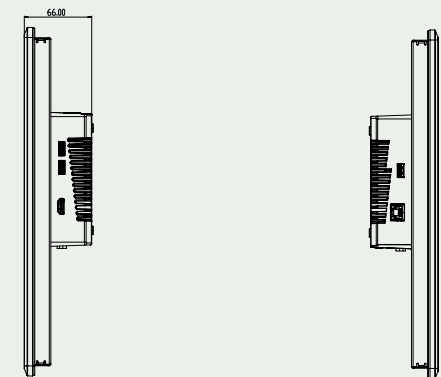
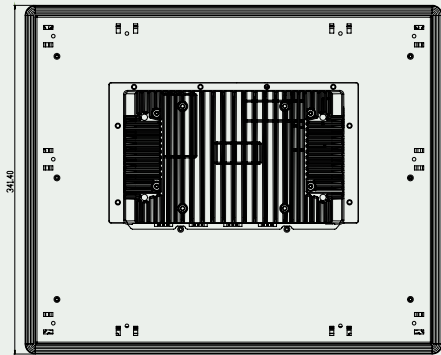
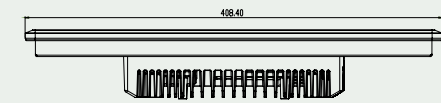

## Specifications

Model	PPC2-C170-ADLP		
LCD Display	17" (5:4)		
Resolution	1280 (W) x 1024 (H)		
Brightness	350 cd/m <sup>2</sup>		
Contrast Ratio	800:1		
LCD Color	16.7M		
Viewing Angle (H-V)	170°/160°		
Backlight MTBF	50,000 hours		
CPU (SoC)	support 12th/13th Generation Intel® Alder Lake-P Core™ i7/i5/i3 Processor		
Memory	Dual channel On board LPDDR4x 8G (max 32GB)		
Touchscreen	PCAP with USB interface (anti-UV/AG coating)		
Touch Controller	Surface hardness: ≥7H Projected capacitive type: EETI 80		
Ethernet	LAN1: Intel® I226V 2.5GbE controller LAN2: Intel® I226-LM 2.5GbE controller (support Intel® AMT )		
Expansion	1 x M.2 M key 2242 (PCIe Gen4 x4) 1 x M.2 M key 2280 (PCIe Gen4 x4)		
Mounting	VESA 100, Panel, Wall, Rack, Stand and Arm		
Construction Material	Aluminum front cover and sheet metal rear cover		
Enclosure Color	Silver+Black		
I/O Ports, Switch	2 x RS-232 by DB9 2 x RS-232/422/485 by DB9 1 x Reset button	1 x HDMI output 1 x 12V DC Jack 1 x Power button 1 x AT/ATX switch	2 x USB 3.2 Gen2 2 x USB 3.2 Gen1 1 x USB 2.0
Thermal Solution	Fanless		
Power Input	DC 12V		
Power Consumption	12V@4.63A (Intel® Core i7-1270PE With 8GB LPDDR4 Memory)		
TPM	Intel® Platform Trust Technology		
Watchdog Timer	Software Programmable support 1~255 sec. system reset		
Operating Temperature (with air flow)	-10°C ~ 50°C		
Storage Temperature	-20°C ~ 60°C		
Humidity	10% ~ 95%@40°C, non-condensing		
IP Level	IP65 compliant front panel		
Safety and EMC	CE, FCC Class A, UKCA		
Operation Vibration	MIL-STD-810G 514.6C-1(with SSD)		
Operation Shock	Half-sine wave shock 5G; 11ms; 100 shocks per axis		
Dimensions (H x W x D)	408.40 x 341.40 x 66.00 (mm)		
Cutout Dimensions(mm)	391 x 324.60		
Net Weight	4.890 kg		
ErP	ErP 2009/125/EC		
OS	Windows 10/11 IoT, Linux		

## Ordering Information

PPC2-C170-ADLP-i7/16G-R11	17" 350cd/m <sup>2</sup> 1280x1024 Fanless Panel PC with 12th Generation Intel® Core™ i7-1260P on-board Processor,TDP 28W,16GB LPDDR4x on-board, PCAP touch,12V DC,R11
PPC2-C170-ADLP-i5/8G-R11	17" 350cd/m <sup>2</sup> 1280x1024 Fanless Panel PC with 12th Generation Intel® Core™ i5-1240P on-board Processor,TDP 28W,8GB LPDDR4x on-board, PCAP touch,12V DC,R11
PPC2-C170-ADLP-i3/8G-R11	17" 350cd/m <sup>2</sup> 1280x1024 Fanless Panel PC with 12th Generation Intel® Core™ i3-1220P on-board Processor,TDP 28W,8GB LPDDR4x on-board, PCAP touch,12V DC,R11

## Packing List

Power Cord*1	Power Adapter*1	QIG*1	Thermal Pad*1
--------------	-----------------	-------	---------------

## Options

Item	Part No.	Description
Arm	ARM-11-RS	VESA 75/100 Desk Arm
Stand	STAND-C12-R10	VESA 75/100 Easy Stand
Wall	AFLWK-19B	Monitor Wall Mount Kit