

PPC2-C150-ADLP

iEi Heavy Industrial Panel PC

Powered by Intel® Alder Lake-P



www.ieiworld.com



PPC2-C150-ADLP

Fanless panel PC with narrow bezel design, Intel® Alder Lake-P platform, on-board 8GB memory, HDMI output, dual 2.5GbE LAN, two RS-232, two RS-232/422/485, five USB, two M.2 M key expansion slots, and anti-glare & anti-UV 10-point touchscreen



12th Gen Intel® Alder Lake-P Platform

Powered by 12th generation Intel® Alder Lake-P Series processors and asynchronous architecture, unleashing superior performance.

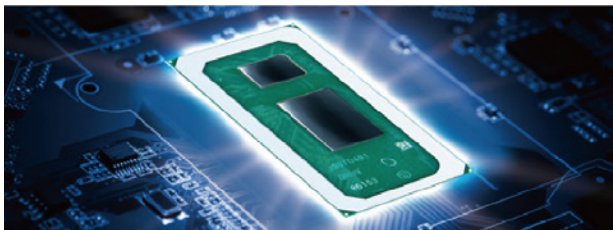

Dual full-speed M.2 expansion slots

Two M.2 M keys support 2242 and 2280 size, PCIe Gen4 x 4 full speed signal, more bandwidth, faster speed.

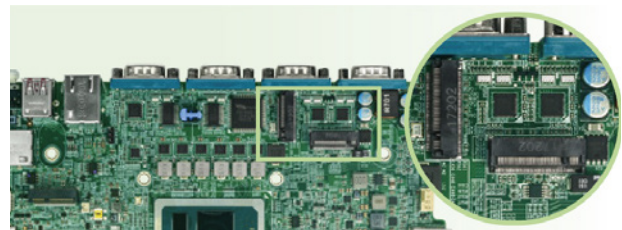

Anti-glare and Anti-UV PCAP

With anti-glare and anti-UV coating, the 10-point touchscreen can display clearly without reflection for a long time use in outdoors and bright light environment.



Works with Gloves and Water

The equipped capacitive touch screen supports gloved operation and waterproof function that can effectively eliminate false touch operating caused by water spray.



Extensive I/O Interfaces

The panel PC is small, but comes with abundant I/O for a variety of application scenarios. It includes four UART, five USB, two 2.5G network port and one HDMI interface.



IP65 rated front panel protection

With the IP65 front panel protection rating, this series is more durable and rugged, ensuring reliable operation in harsh industrial environments.

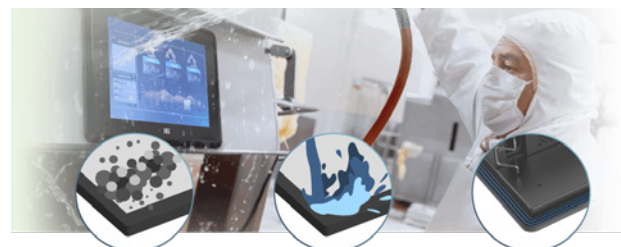

Fully Integrated I/O

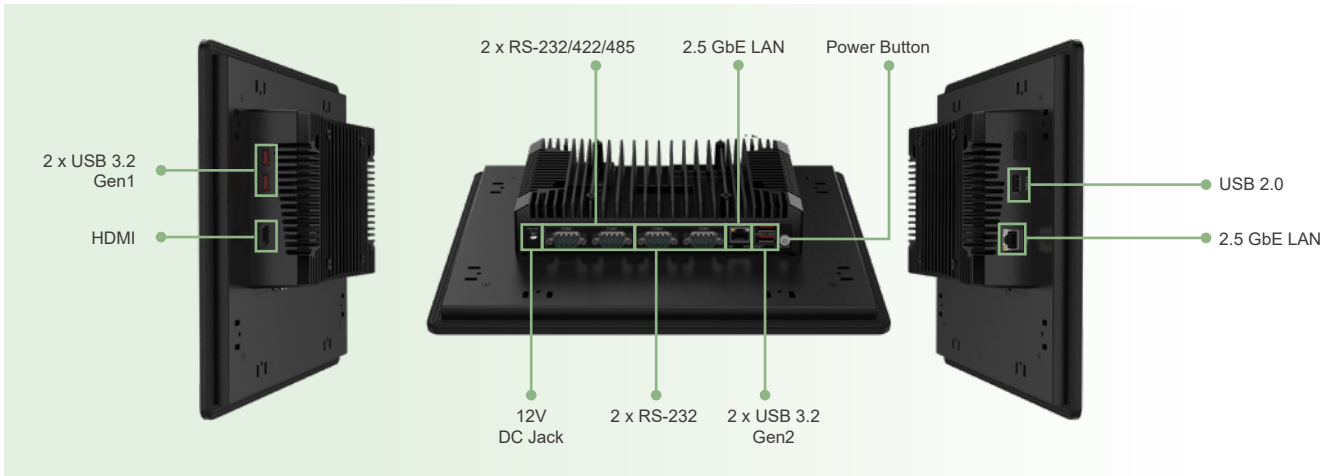

Block Diagram

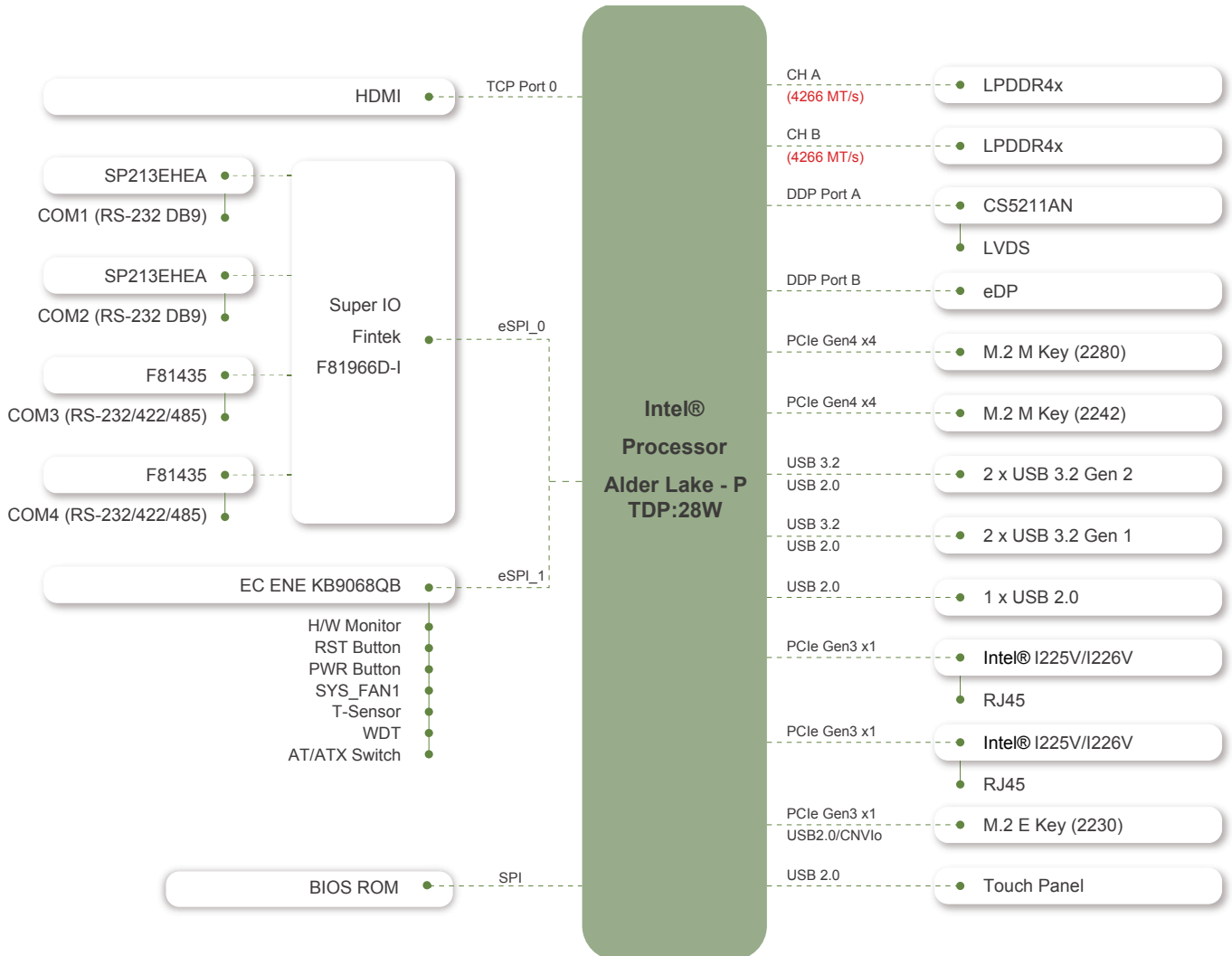

Dimensions (Unit: mm)

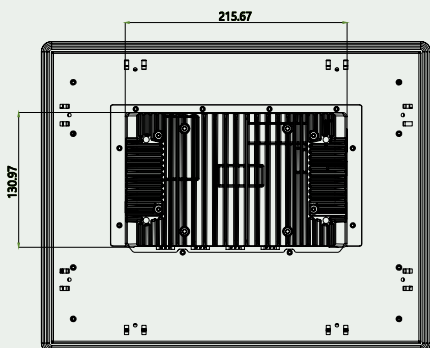
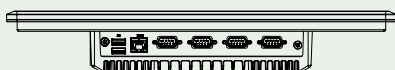
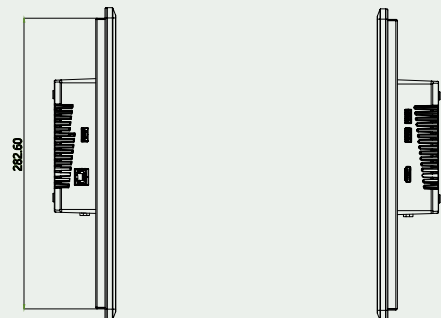
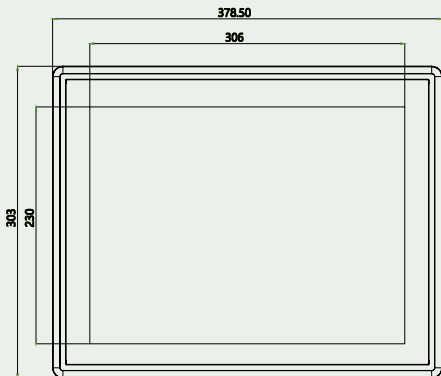
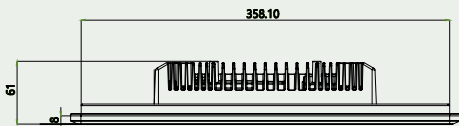

Specifications

Model	PPC2-C150-ADLP		
LCD Display	15"(4:3)		
Resolution	1024 (W) x 768 (H)		
Brightness	400 cd/m ²		
Contrast Ratio	800:1		
LCD Color	16.2M		
Viewing Angle (H-V)	176°/176°		
Backlight MTBF	70,000 hours		
CPU (SoC)	support 12th/13th Generation Intel® Alder Lake-P Core™ i7/i5/i3 Processor		
Memory	Dual channel On board LPDDR4x 8G (max 32GB)		
Touchscreen	PCAP with USB interface (anti-UV/AG coating)		
Touch Controller	Surface hardness: ≥7H Projected capacitive type: EETI 80		
Ethernet	LAN1: Intel® I225V/I226V 2.5GbE controller LAN2: Intel® I225-LM/I226-LM 2.5GbE controller (support Intel® AMT)		
Expansion	1 x M.2 M key 2242 (PCIe Gen4 x4) 1 x M.2 M key 2280 (PCIe Gen4 x4)		
Mounting	VESA 100, Panel, Wall, Rack, Stand and Arm		
Construction Material	Aluminum front cover and sheet metal rear cover		
Enclosure Color	Silver+Black		
I/O Ports, Switch	2 x RS-232 by DB9 2 x RS-232/422/485 by DB9 1 x Reset button	1 x HDMI output 1 x 12V DC Jack 1 x Power button 1 x AT/ATX switch	2 x USB 3.2 Gen2 2 x USB 3.2 Gen1 1 x USB 2.0
Thermal Solution	Fanless		
Power Input	DC 12V		
Power Consumption	12V@5.56A (Intel® Core i7-1270PE With 8GB LPDDR4 Memory)		
TPM	Intel® Platform Trust Technology		
Watchdog Timer	Software Programmable support 1~255 sec. system reset		
Operating Temperature (with air flow)	-10°C ~ 50°C		
Storage Temperature	-20°C ~ 60°C		
Humidity	10% ~ 95%@40°C, non-condensing		
IP Level	IP65 compliant front panel		
Safety and EMC	CE, FCC Class A, UKCA		
Operation Vibration	MIL-STD-810G 514.6C-1(with SSD)		
Operation Shock	Half-sine wave shock 5G; 11ms; 100 shocks per axis		
Dimensions (H x W x D)	375.80 x 303.00 x 61.00 (mm)		
Net Weight	4.125 kg		
ErP	ErP 2009/125/EC		
OS	Windows 10/11 IoT, Linux		

Ordering Information

PPC2-C150-ADLP-i7/8G-R10	15" 400cd/m ² 1024x768 Fanless Panel PC with 12th Generation Intel® Core™ i7-1260P on-board Processor, TDP 28W, 8GB LPDDR4x on-board, PCAP touch, 12V DC, R10
PPC2-C150-ADLP-i5/8G-R10	15" 400cd/m ² 1024x768 Fanless Panel PC with 12th Generation Intel® Core™ i5-1240P on-board Processor, TDP 28W, 8GB LPDDR4x on-board, PCAP touch, 12V DC, R10
PPC2-C150-ADLP-i3/8G-R10	15" 400cd/m ² 1024x768 Fanless Panel PC with 12th Generation Intel® Core™ i3-1220P on-board Processor, TDP 28W, 8GB LPDDR4x on-board, PCAP touch, 12V DC, R10

Packing List

Power Cord*1	Power Adapter*1	QIG*1	Thermal Pad*1
--------------	-----------------	-------	---------------

Options

Item	Part No.	Description
Arm	ARM-11-RS	VESA 75/100 Desk Arm
Stand	STAND-C12-R10	VESA 75/100 Easy Stand
Wall	AFLWK-19B	Monitor Wall Mount Kit