

PPC2-C08-EHL

IEI Heavy Industrial Panel PC

Powered by Intel® Elkhart Lake Platform



www.ieiworld.com



PPC2-C08-EHL

Panel PC equips Intel® Celeron® J6412 processor, on-board 8GB memory, HDMI display output, dual 2.5G Ethernet port, one M.2 M key & one M.2 B key expansion slots, 12~24V DC input, anti-glare and anti-UV 10-point touchscreen

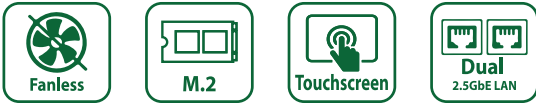

IP2EHL_XC Expansion Interface

The IP2EHL_XC¹ connector allows users to flexibly expand functionality such as network, serial ports and CAN to meet various application requirements. (IEI-designed pin definition, supported functions are customized, for models of 10-inch or above)

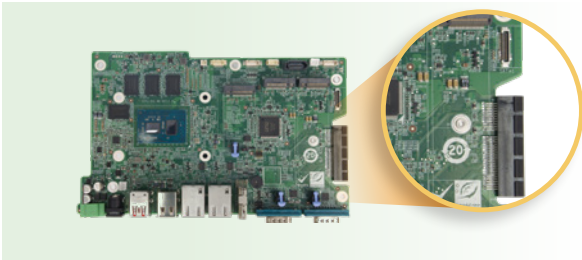

M.2 B Key & M.2 M Key

Dual M.2 ultra-high-speed expansion supporting SSD & AI accelerator to enhance efficiency.

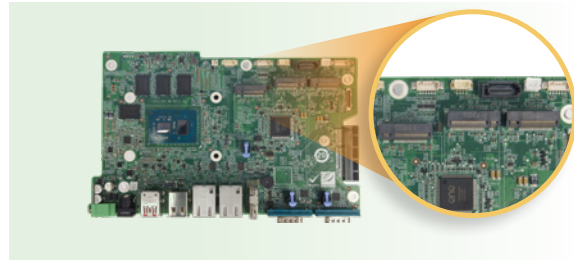

Anti-glare and Anti-UV PCAP

With anti-glare and anti-UV coating, the 10-point touchscreen can display clearly without reflection.



Support Gloved and Wet Hand Operation

The whole new PCAP screen allows you to accurately manage every step of your operations even with gloves or in wet conditions.



Newly Designed Panel Mount Kit

The new refined and convenient panel mount kit can be easily fastened by hand, no screwdriver required.



New Graphical BIOS Interface

Upgraded with new BIOS interface, which can be navigated with fingers, no keyboard and mouse are required to operate.

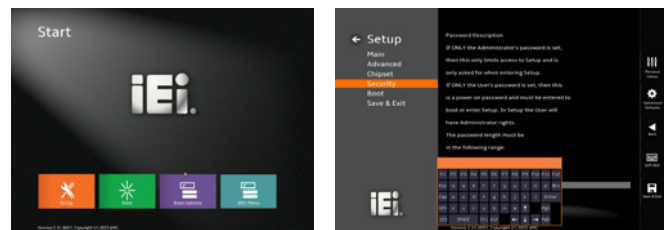

¹ IEI-designed pin definition, supported functions are customized, for models of 10-inch or above

Fully Integrated I/O

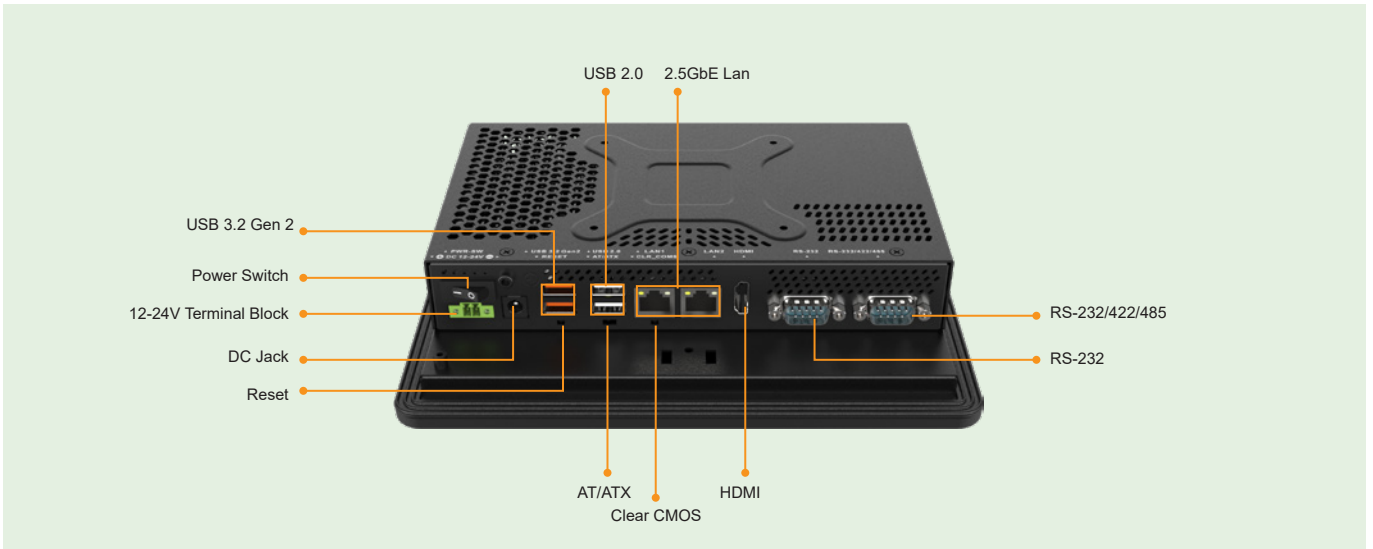

Block Diagram

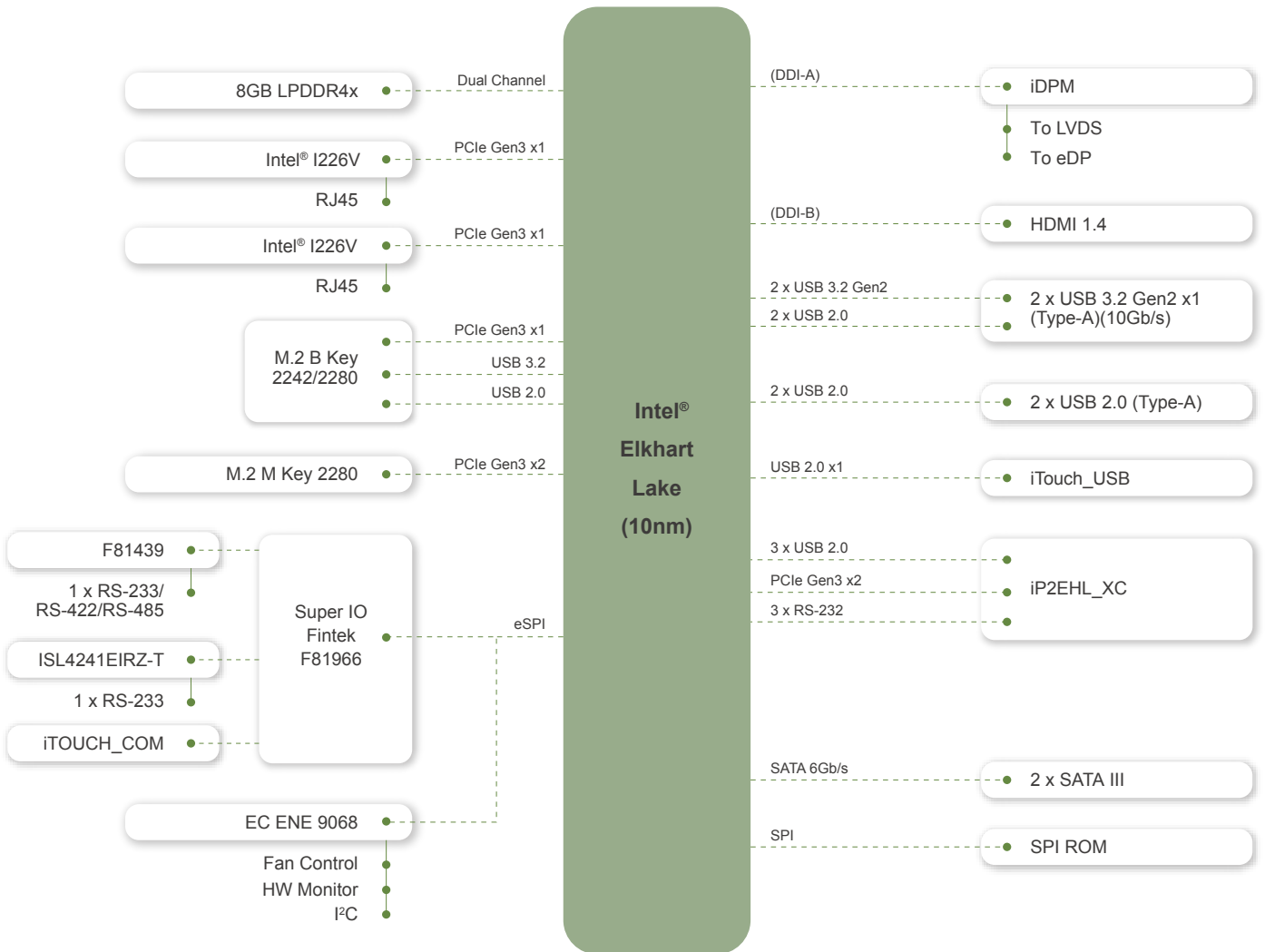

Dimensions (Unit: mm)

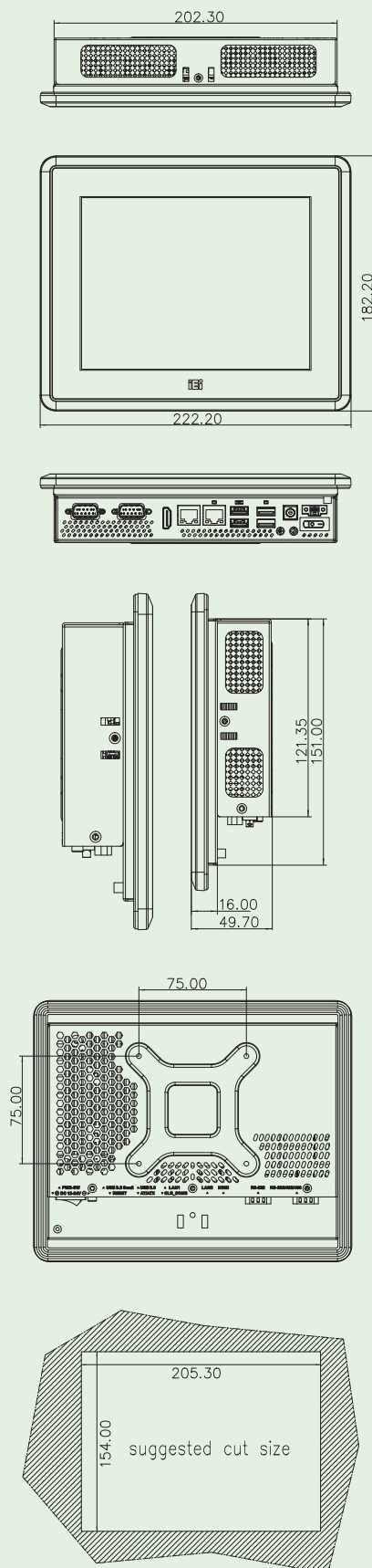

Specifications

	PPC2-C08-EHL
LCD Display	8" (4:3)
Resolution	800 (W) x 600 (H)
Brightness	500 cd/m ²
Contrast Ratio	500:1
LCD Color	262K
Pixel Pitch (mm)	0.2025 x 0.0675
Viewing Angle (H-V)	140°/120°
Backlight MTBF	50,000 hours
SBC Model	PPC2MB2-EHL-RC-R10
CPU (SoC)	Intel® Celeron® Processor J6412 1.5M Cache, up to 2.60 GHz / TDP 10w
Memory	8GB dual-channel on-board LPDDR4X (up to 16GB)
Touchscreen	Multi-point projected capacitive type (anti-UV / anti-glare coating, support gloves) Surface hardness: ≥7H
Touch Controller	Projected capacitive type: EETI 80
Ethernet	2 x 2.5GbE LAN via Intel I226-V
Expansion	1 x M.2 2242/2280 B key (PCIe Gen3 x1 + USB 3.0) 1 x M.2 2280 M key (PCIe Gen3 x2)
Mounting	VESA 75 mm x 75 mm Panel, Wall, Stand and Arm
Construction Material	Aluminum front cover and sheet metal rear cover
Enclosure Color	Black
I/O Ports, Switches and Buttons	1 x HDMI output 2 x RJ-45 2.5GbE 2 x USB 3.2 Gen 2x1 (10Gb/s) 2 x USB 2.0 1 x RS-232/422/485 1 x RS-232 1 x 12V-24V power jack 1 x Power terminal block (2-pin) 1 x AT/ATX switch 1 x Power button 1 x Reset button 1 x Clear CMOS button
Power Input	12 V ~ 24 V DC
Power Consumption	+12V @ 3.147A (Intel® Celeron J6412 with 8GB memory)
Thermal Solution	Fanless
TPM	Intel® Platform Trust Technology
Watchdog Timer	Software Programmable support 1~255 sec. system reset
Operating Temperature (with air flow)	-10°C ~ 60°C
Storage Temperature	-20°C ~ 60°C
Humidity	10% ~ 95%, non-condensing
IP Level	IP 65 compliant front panel
Safety and EMC	CE, FCC Class A, UKCA
ErP	ErP 2009/125/EC
Dimensions(H x W x D) (mm)	222.2 x 182.2 x 49.7
Cutout Dimensions(mm)	205.30 x 154.00
Net Weight	1.635kg

Packing List

1 x Power Cord	1 x Power Adapter	1 x QIG
1 x Panel Mount Kit	1 x Screw Pack	

Ordering Information

PPC2-C08-EHL-J1/8G-R11	8" 500 cd/cm ² 800x600 Panel PC with Intel® Celeron® Processor J6412, 8GB LPDDR4x on-board, HDMI output, black, 12-24V DC input, projected capacitive touchscreen with AG, R11
------------------------	---

Options

Item	Part No	Description
Arm	ARM-11-RS	VESA 75/100 Desk ARM
Stand	STAND-C12-R10	VESA 75/100 Easy Stand
Wall Mount Kit	AFLWK-12	Monitor Wall mounting kit
OS	PPC2-EHL-W10IoT21-E-R11	OS Image with Windows®10 Enterprise Entry 64-bit 2021 LTSC for PPC2-EHL Series