

AFL3-W15C-ADLP

iEi 威强电轻工业平板电脑

搭载第十二代英特尔® 酷睿™ 移动处理器



iEi 威强电
www.ieiworld.com.cn

AFL3-W15C-ADLP

无风扇高性能平板电脑，支持第 12 代 Intel® Core™ i7/i5/i3 处理器、8GB DDR4 内存、HDMI 输出、双 2.5GbE LAN、IPMI 远程管理、3 个 M.2 扩展槽，以及防眩光、抗紫外线的 10 点电容触摸屏，符合 RoHS

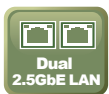

第十二代英特尔®酷睿™移动处理器

第十二代英特尔®酷睿™移动处理器具有全新的混合架构，超强性能和丰富扩展带来卓越体验。



支持4K超高清显示输出

第10代英特尔®超高清显卡引擎，允许系统通过HDMI1.4b以极高的4K分辨率显示视频和图像。



防眩光与抗紫外的电容触控屏

配有防眩光和防紫外线涂层，支持10点触控，在户外和强光环境下长时间使用显示画面仍清晰可见。

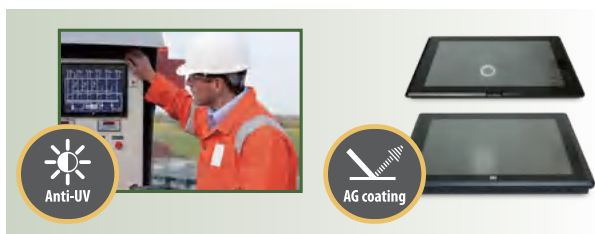

支持WiFi6E和蓝牙5.2

更强的WiFi6E网络，支持更多的信号频段、更大带宽、更低时延，并且，蓝牙5.2的连接更稳定，功耗更低。



IPMI 2.0 远程管理

配合IEI iRIS扩展卡，可支持通过网络远程管理系统，进行OS安装与恢复，开机或关机等操作。

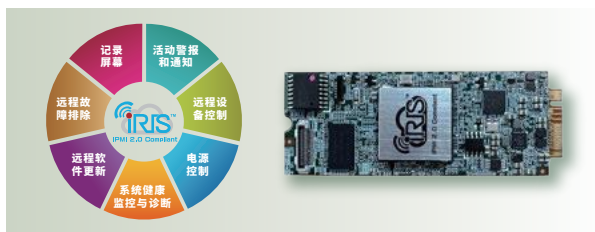

双全速M.2扩展卡槽

两个M.2 M-key插槽可支持2280尺寸的M.2模块，并支持PCIe Gen4 x4全速信号，更大带宽、更快速度。

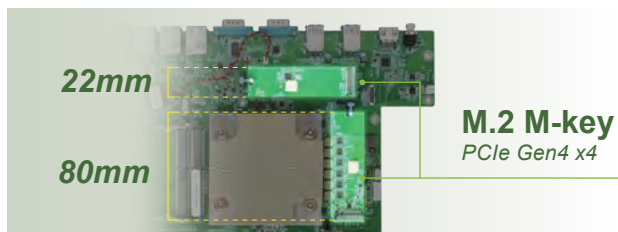

AFL3-W15C-ADLP IO 布局

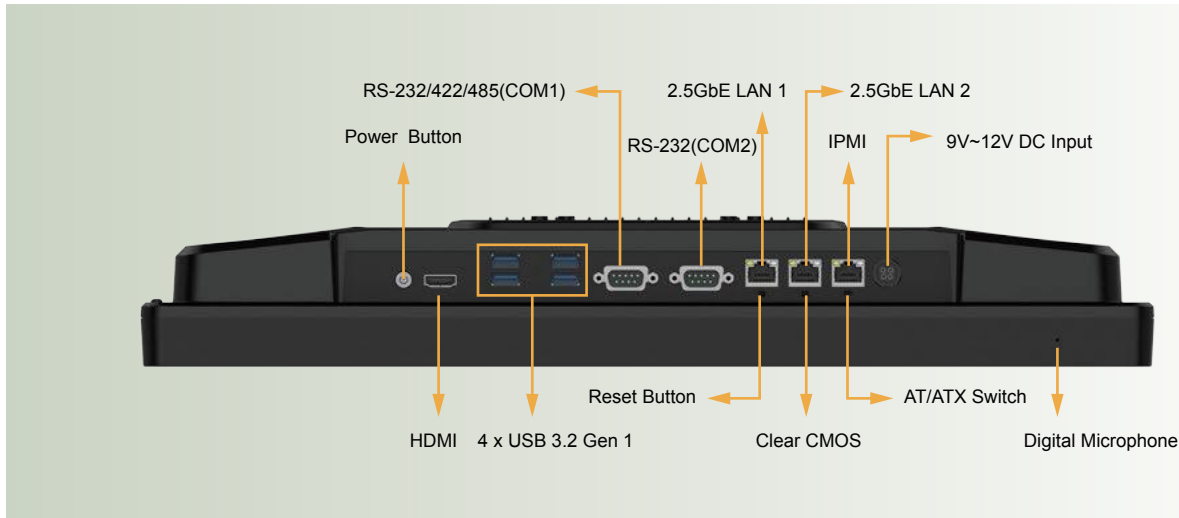

AFL3-W15C-ADLP Block Diagram

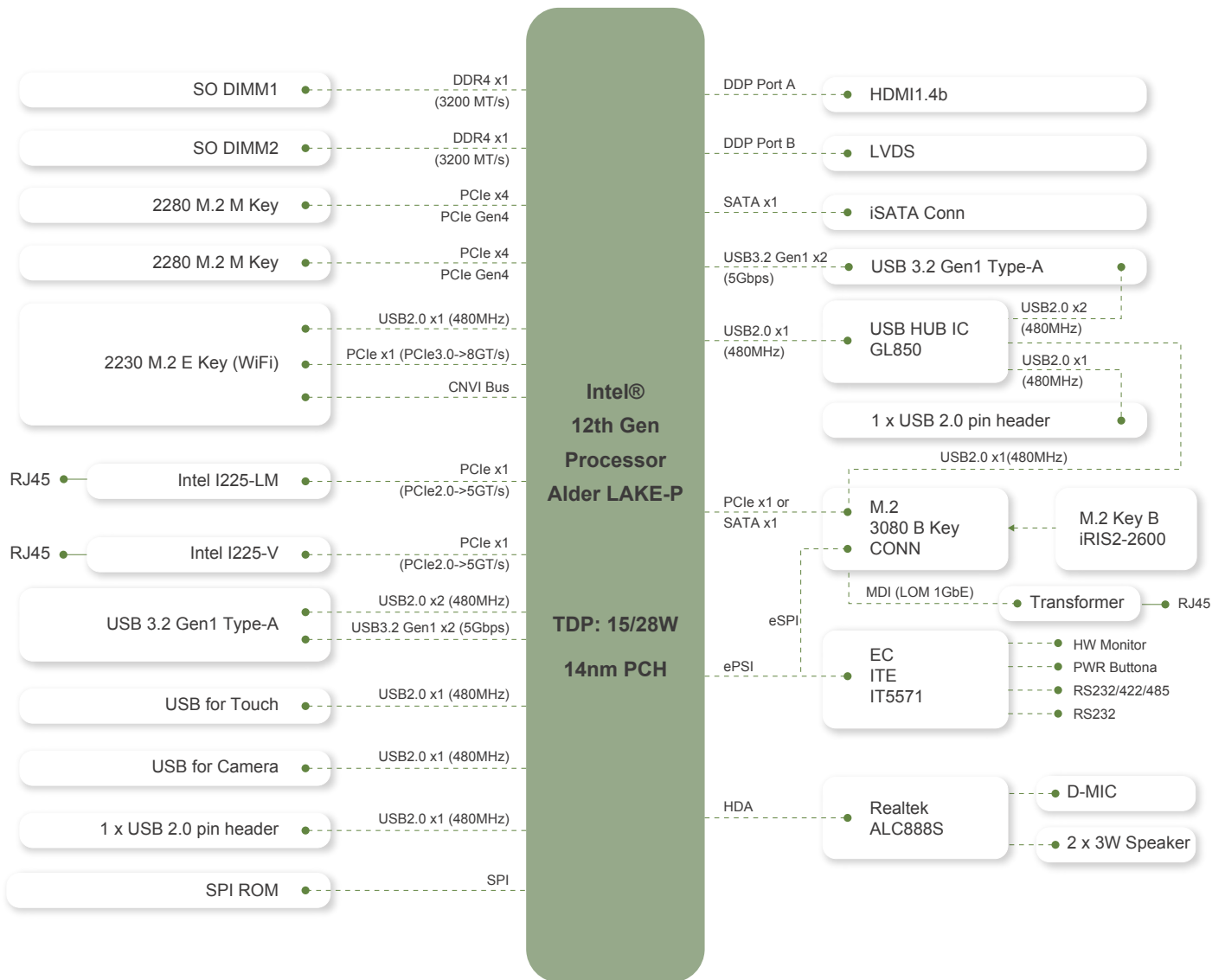

尺寸 Dimensions

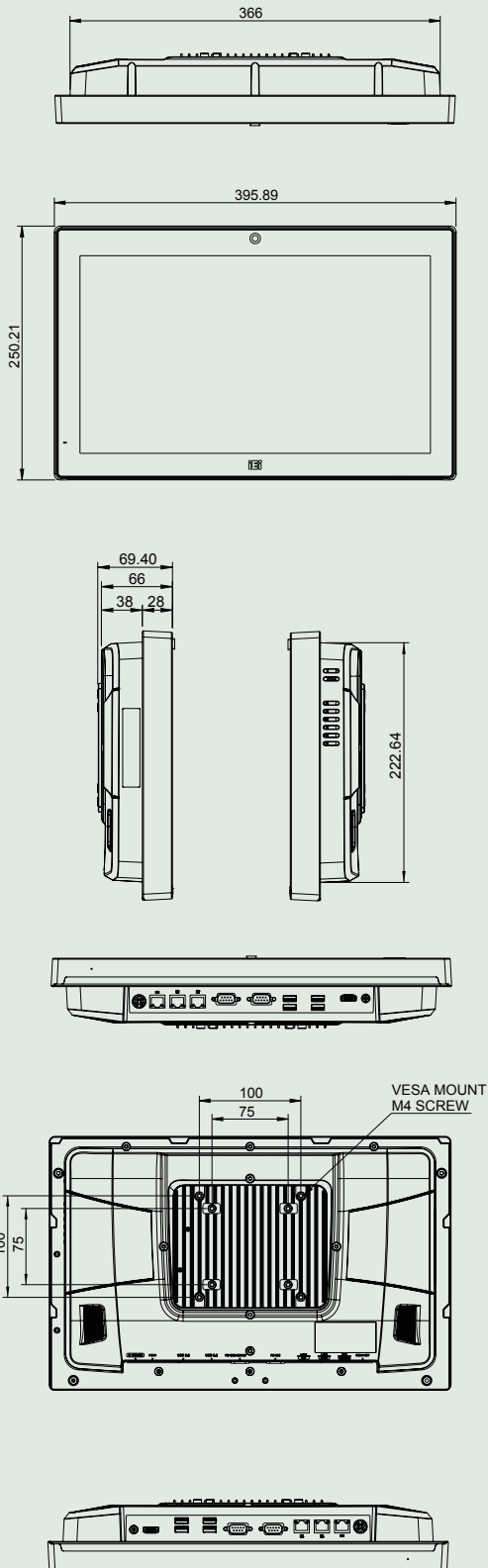

规格 Specifications

型号		AFL3-W15C-ADLP	
LCD	尺寸	15.6"	
	分辨率	1920 x 1080 (16:10)	
	亮度 (cd/m ²)	450	
	对比度	800	
	可视角度 (H-V)	170/170	
	背光 MTBF	50000	
Touch	触摸屏	PCAP with USB interface (anti-UV/AG coating)	
	触摸控制器	EXC3160	
Mainboard	CPU	12th Gen Intel® Core™ Mobile i7/i5/i3 Processors (Alder Lake-P)	
	内存	Two 260-pin 3200 MHz dual-Channel DDR4 SO-DIMM (8G Pre-installed) (max. 32GB)	
	网络	LAN1: Intel® I225 LM(support Intel AMT) + LAN2: Intel® I225V	
	音频编解码器	ALC888S	
	存储	1 x 2.5" SATA 6G/s HDD bay	
	扩展	2 x M.2 2280 M-key (PCIe4) 1 x M.2 3080 B-key (PCIe1 or SATA) support IPMI function	
	I/O 接口 & 开关		1 x RS-232 by DB9 1 x RS-232/422/485 w/ AFC by DB9 2 x 2.5GbE LAN 1 x RJ45 for IPMI 4 x USB 3.2 Gen1
			1 x HDMI output
			1 x 12V DC Jack
			1 x Power Button
		1 x Reset Button	
		1 x ClearCMOS Button	
		1 x AT/ATX Switch	
音频		AMP 3W + 3W (internal speaker)	
摄像头 / 麦克风		2-megapixel with low light function, digital microphone	
无线 & 蓝牙		IEEE 802.11ax 2T2R module (Wi-Fi 6E) with BT v5.2 (M.2 2230 E-key)	
机身	前面板材质	PC + ABS Plastic	
	安装方式	VESA 75 /100mm	
	颜色	Black C	
环境	工作温度 (° C)(有气流)	0 ~ 50	
	存储温度 (° C)	-20 ~ 60	
	湿度	10 ~ 90RH@40° C (non-condensing)	
	IP 等级	IP 64 compliant front panel	
	安规 & EMC	CE, FCC (Class A), UKCA	
散热方案		Fanless	
电源	电力需求	12V DC	
ErP		ErP 2009/125/EC	
支持系统		Microsoft Windows® 10/11 IoT, Linux	

包装清单 Packing List

1 x Power cord	1 x Screw
1 x Power adapter	1 x QIG

订购信息 Ordering Information

型号	描述
AFL3-W15C-ADLP-i3/8G-R10	Wide 15.6" 450cd/m ² 1920x1080 Panel PC with 12th Generation Intel® Core™ i3-1220P on-board processor, PCAP touch, 2M camera, microphone, 1x8GB DDR4 RAM, with AG, RoHS
AFL3-W15C-ADLP-i5/8G-R10	Wide 15.6" 450cd/m ² 1920x1080 Panel PC with 12th Generation Intel® Core™ i5-1240P on-board processor, PCAP touch, 2M camera, microphone, 1x8GB DDR4 RAM, with AG, RoHS
AFL3-W15C-ADLP-i7/8G-R10	Wide 15.6" 450cd/m ² 1920x1080 Panel PC with 12th Generation Intel® Core™ i7-1260P on-board processor, PCAP touch, 2M camera, microphone, 1x8GB DDR4 RAM, with AG, RoHS

可选配件 Optional accessories

组件	料号
Wall Mounting Kit	AFLWK-19B
Arm	ARM-11-RS
Stand	STAND-A21-R10/ STAND-210-R11/STAND-C19-R10
IPMI card	iRIS2-2600-R10