



MPOCm-W24

Mobile Medical Monitor

- Support up to 3 pcs TC-202GA 9000mAh hot swappable battery pack
- 2 Configurable DC outputs
DC OUT1: Selectable 19V, 24V (Max: 55W)
DC OUT2: Selectable 5V, 12V, 15V, 19V, 24V (Max: 50W)
- IP65 front bezel
- 10-point PCAP touchscreen
- 23.8" (1920x1080) medical monitor



1920 x 1080 Resolution TFT LCD
with Glove-Friendly PCAP Multi-Touch



24/7 Runtime with
Three Hot-Swappable Batteries



DC-Output to Power Computer
and Peripherals



IP65 Sealed Front Panel for
Easy Cleaning and Infection control



Embedded WiFi Antennas



Intelligent Battery Management



USB Hub Integration



Easy Cable Management

Three Hot-Swappable Batteries for Easy Maintenance

1000 Cycle
Battery Life cycle



Battery Pack - TC-202GA

Part Number: 31603-000106-RS

Optional

3.5 hr
Quick Charge



6-Bay Charging Station

Part Number: POCm-DOCKING-6BAY

Optional

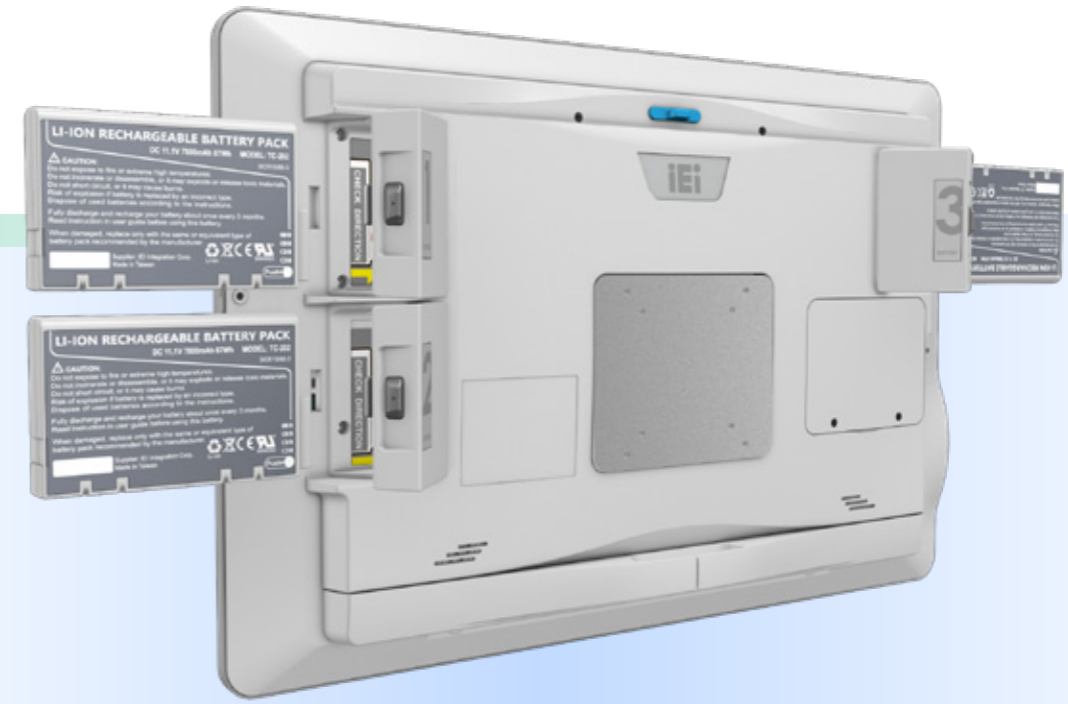

- Large 9000mAh / 97.2Wh high-capacity lithium-ion battery packs.
- You can add or replace batteries without turning off the monitor system or disrupting its operation, reducing downtime.

Life Cycle Breakthrough

IEI's latest TC-202GA Battery features the new generation battery cell with the innovative discharge mechanism, which reduces the power decline rate, thereby doubling the battery's life cycle.

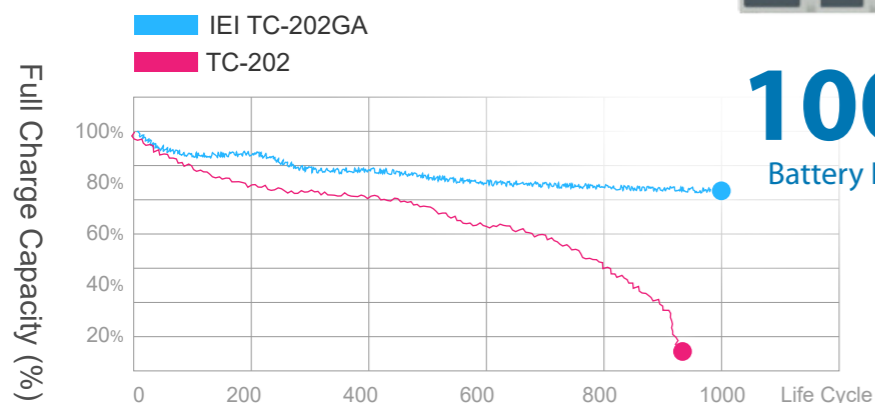
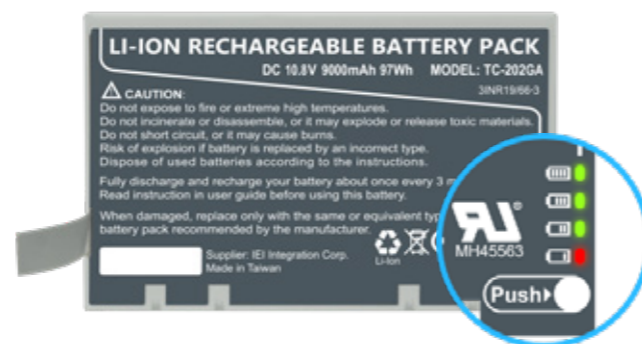

1000 Cycle
Battery Life cycle

- 100%
- 75%
- 50%
- 25%

Parallel Charge Maximizes the Battery's Efficiency

The MPOCm-W24 dynamically adjusts the charging and discharging order based on voltage differences between the batteries, prioritizing the battery with the highest or lowest voltage to achieve balance, thereby maximizing charge and discharge efficiency.

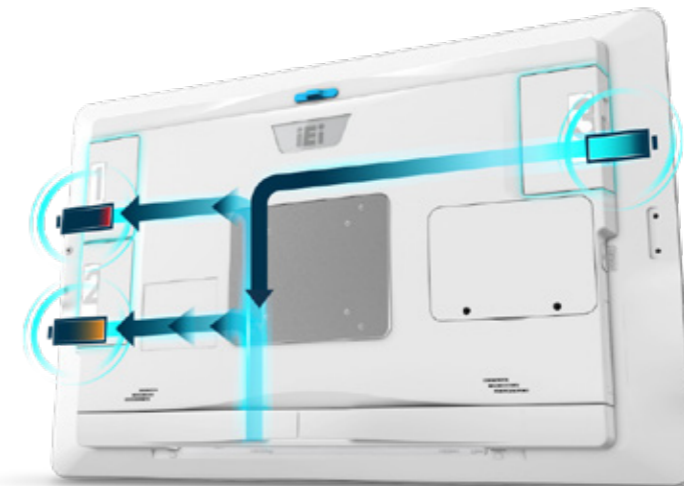

For Cost-Effective and Lightweight Non-Powered Medical Cart Solution

There's nothing more frustrating for a nurse than starting a shift only to find the nursing cart battery is dead or flat. This not only disrupts workflow but also delays patient care. The IEI MPOCm-W24 eliminates these frustrations with long battery runtime, quick recharges, and seamless power.

- Extended Runtime:** The MPOCm provides a 12 to 16-hour runtime per charge, easily covering an entire nursing shift.
- Quick Charging:** The batteries charge in just 3 hours, significantly reducing downtime and making the computer cart more readily available for use.
- Cost Savings:** Non-powered carts are generally less expensive than powered carts, both in initial purchase and ongoing maintenance.
- Lightweight and Enhance Mobility:** The MPOCm-W24's batteries weigh only 1.5 kg compared to traditional batteries weighing 7-12 kg, reducing cart weight by up to 10 kg, making them more maneuverable and less physically demanding for nurses.

***Note:** Battery runtime is calculated based on the use of three batteries with the system running at full load, without the use of the two DC outputs for additional equipment.

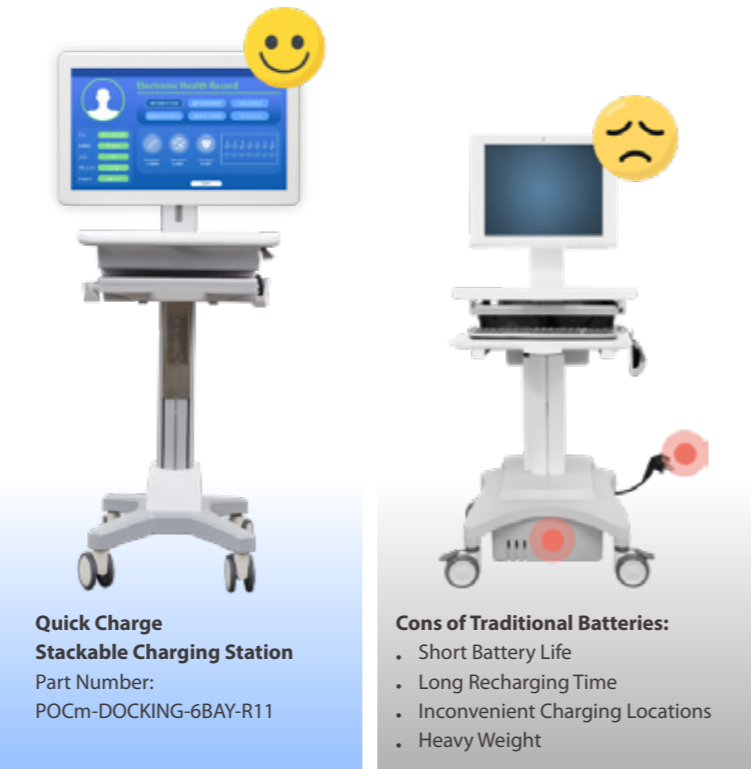

Where to Use

The MPOCm-W24 is the perfect choice for various non-powered medical cart applications, thanks to its lightweight design, anti-vibration features, and high performance battery system.



Medication Dispensing Cart

Nursing Cart

Dual Monitor Medical Cart

105W Dual DC Outputs For Computer and Peripherals

With multiple power outputs, the MPOCm-W24 not only supports charging the computers but also supplies power to peripherals when mounted on a rolling cart. It can provide up to 105 watts of power to two devices simultaneously.

Power Condition	Maximum Power Provision for DC Out1 + DC Out2
1 x TC-202GA Battery Pack Installed	19.98 Watt
2 x TC-202GA Battery Pack Installed	60.53 Watt
3 x TC-202GA Battery Pack Installed	105 Watt
Power Adapter without Battery Packs	105 Watt

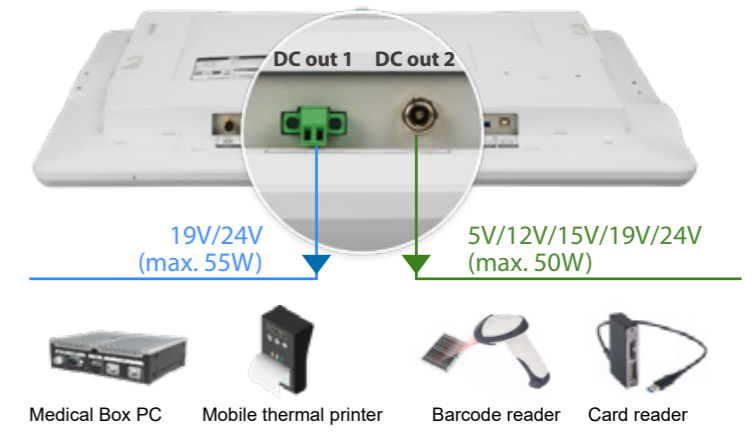

The easy-to-configure switch for two DC outputs allows you to adjust power settings without the need to open the system, reducing downtime and minimizing the risk of system disruption.

DC OUT1		1	2	3	4	5
24V	ON 1 2 3 4 5	On	Off	Off	Off	Off
19V	ON 1 2 3 4 5	Off	On	Off	Off	Off

DC OUT2		1	2	3	4	5
24V	ON 1 2 3 4 5	On	Off	Off	Off	Off
19V	ON 1 2 3 4 5	Off	On	Off	Off	Off
15V	ON 1 2 3 4 5	Off	Off	On	Off	Off
12V	ON 1 2 3 4 5	Off	Off	Off	On	Off
5V	ON 1 2 3 4 5	Off	Off	Off	Off	On

- *Note:**
- Please ensure the user powers on the device and verifies the voltage output is correct (using a voltmeter or app) before connecting the device.
 - Warning! Please ensure the user sets the power switch exactly as described in the instructions. Incorrect settings may result in an abnormal voltage of 31.5V.
 - If a power output short circuit occurs, the system will enter protection mode. After the short circuit condition is resolved, the user needs to restart the device for the DC output to resume power supply.

Glove Detectable and Water Handling Multi-Touch Screen

- No false signals are generated when water, saline, or blood—high dielectric constant liquids—splash onto the touch surface.
- Allows caregivers to operate normally whether wearing multi-layer medical gloves or wet hands.
- 10-point multi-touch you can zoom in on medical images or multitask on a single screen.



Medical Gloves
5 Layer

Compatible with
Anti-Normal Saline & Blood
(containing 9.0 g of salt per liter (0.90%))

IP65-Rated for Superior Disinfectant-Tolerant

The MPOCm-W24, featuring a drip-proof enclosure, IP65 front panel, and 7H surface hardness, is designed to endure frequent cleaning and disinfection with alcohol or diluted bleach, ensuring reliable operation and exceptional patient care.



Paired with Box PCs

With a separate system setup, you gain the flexibility to choose the best combination of monitor and box PC to meet specific needs, while also enjoying easier maintenance and upgrades, as individual components can be replaced or upgraded independently, reducing downtime and costs.



Optimize Your Workspace with Cable Simplicity

The streamlined cable setup eliminates clutter, ensuring a clean, organized workspace that supports efficient and seamless workflows.



Embedded Wireless Antennas

The WiFi/Bluetooth connectivity still works well when the Box PCs are mounted or stored in a medical cart.



Integrated USB Hub

With an integrated USB 3.0 Gen 1 (5Gbit/s) hub, the device reduces desk clutter and provides extensive connectivity options for USB peripherals, eliminating the need to bend down to find the USB ports on the main unit.

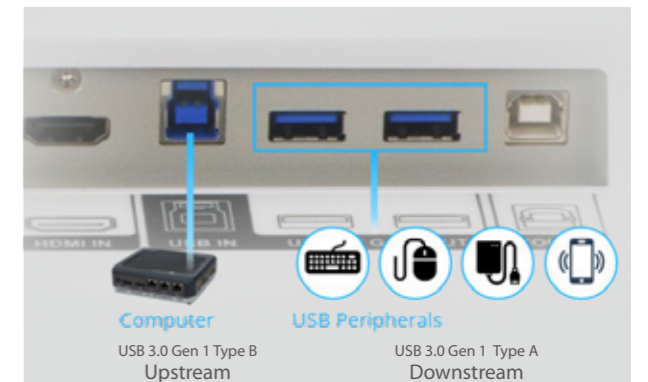

Convenient Cable Management

A smooth and elegant cable cover conceals the cables, ensuring the devices are easier to use and maintain.

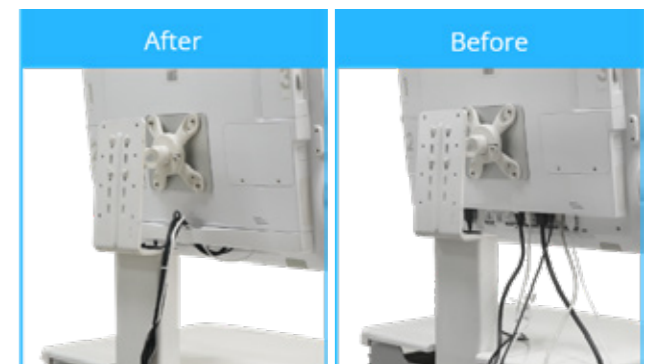

Centralized Remote Battery Monitoring

IEI's Remote Battery Monitoring solution offers precise and continuous monitoring, optimizing battery efficiency, extending run times, and reducing costs. This solution also prevents human errors and eliminates unnecessary and costly truck rolls.

Remote Battery Management Utility

The Battery Remote Utility for Windows and Linux enables IT supervisors to remotely monitor the battery status of MPOCm monitors within the same subnet.

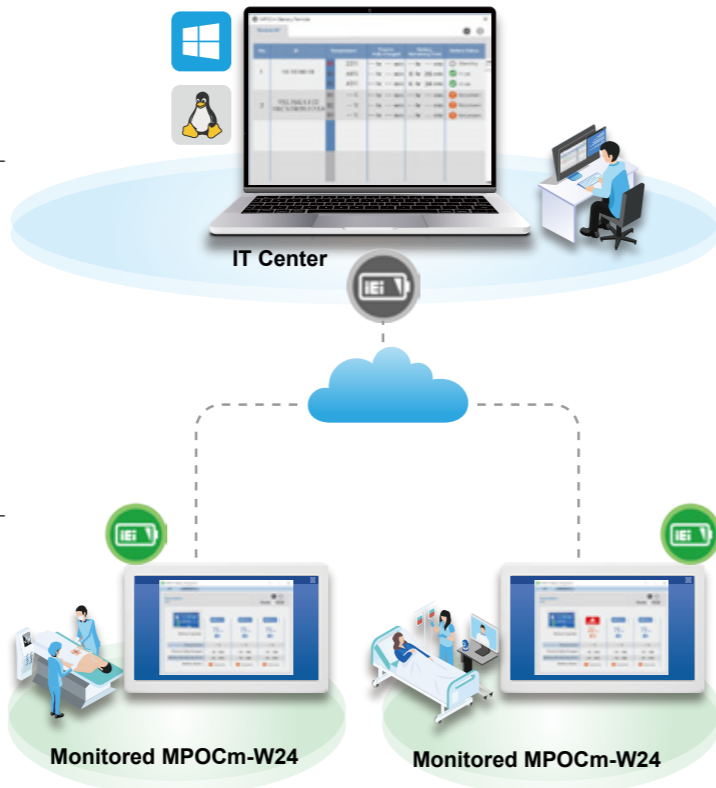

Local Battery Management Utility

The Local Battery Management Utility displays the current status and information of the battery system for users. Low battery capacity triggers an alert message and beep sound.

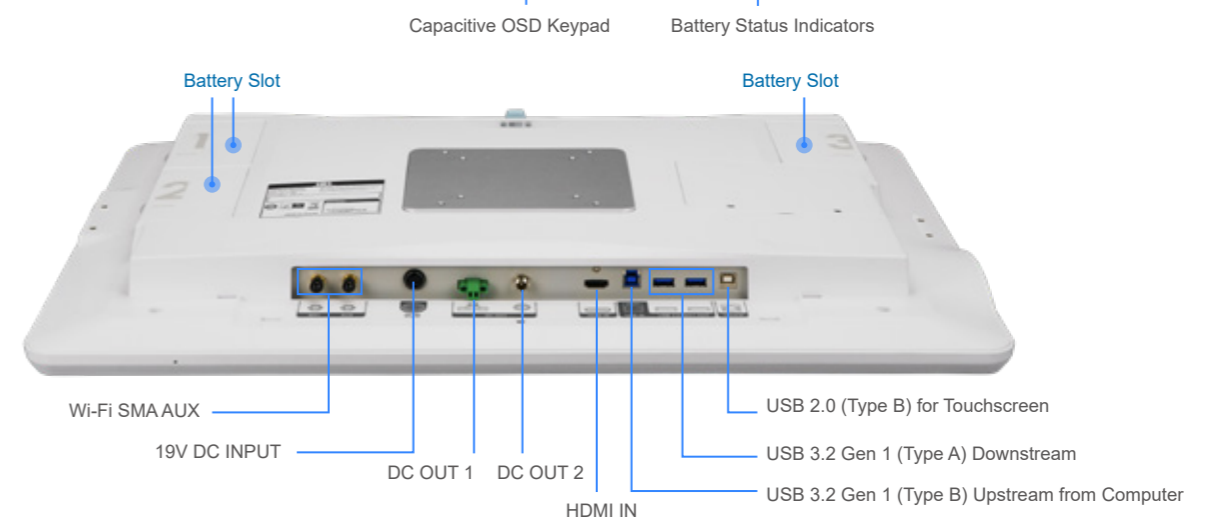

User-Friendly OSD Button Design and Battery Indicators for Enhanced Monitoring



True Flat OSD Hot Key

To adjust the brightness audio, and contrast, simply press a function button and the menus pop-up on the touch screen.



Intuitive Battery Status Indicators

4 stages of discharge on-show at all times. Only a simple glance needed to confirm battery levels.



Dimensions (Unit: mm)

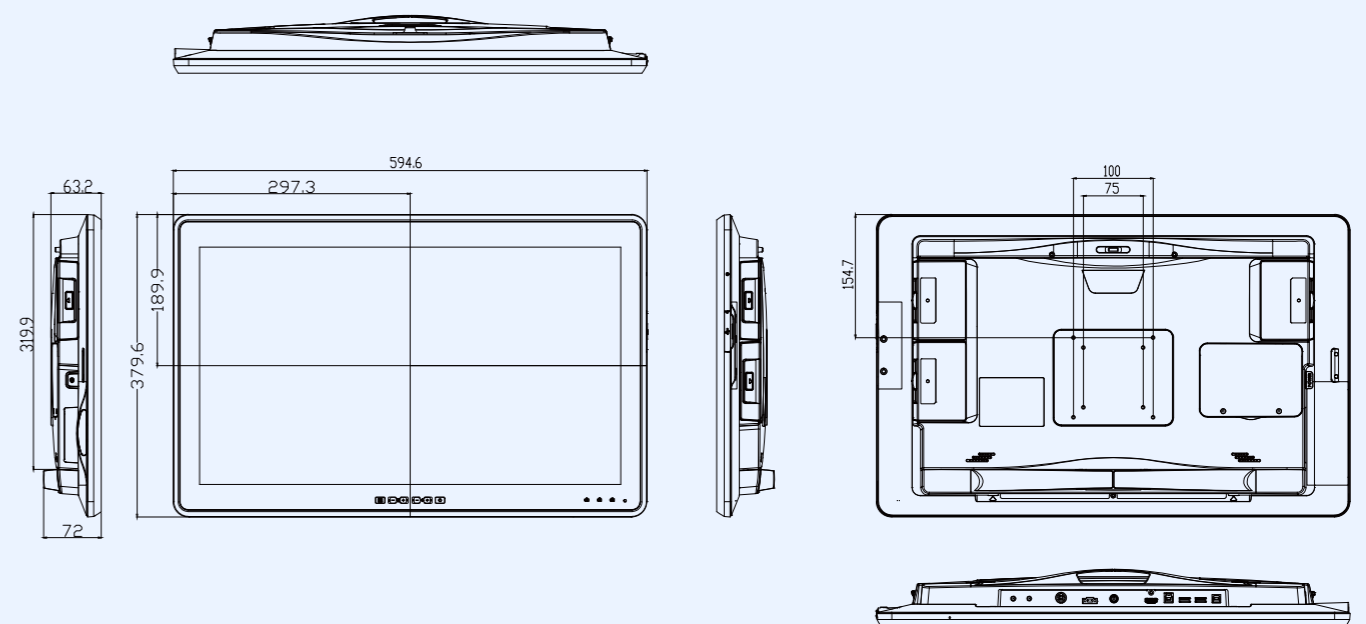

Specifications

Model		MPOCm-W24/PC-R10
LCD Specifications	LCD Size	23.8"
	Max. Resolution (W/H)	1920x1080
	Brightness (cd/m ²)	250
	Contrast Ratio	1000:1
	LCD Color	16.7M RGB 6-bit (Hi-FRC)
	Pixel Pitch (H/V)	0.2745 x 0.2745 mm
	Viewing Angle (H/V)	178°/178°
	Backlight MTBF (hrs)	30,000
Touch	Touchscreen	Projected capacitive type with 10-point multi-touch
	Touch Controller	EETI
System	Surface Hardness	6H
	Audio	2 x 2W speaker
	I/O Port	1 x HDMI-in 1 x DC-in jack 1 x USB 2.0 (black, Type-B) for Touch 1 x USB 3.2 Gen 1 (blue, Type-B) 2 x USB 3.2 Gen 1 (blue, Type-A) 2 x Wi-Fi SMA connector (main/aux) 2 x Variable voltage DC power output for external devices (55W in total) DC OUT1: 19V, 24V (maximum of 55 watts) DC OUT2: 5V, 12V, 15V, 19V, 24V (maximum of 50 watts) *To use battery power, at least 2 batteries must be installed and the DC outputs must work properly.
	OSD Function	1 x LCD on/off 1 x Volume up 1 x Volume down 1 x Brightness up 1 x Brightness down 1 x OSD menu key
	LED	1 x Power Indicator 3 x Battery Indicator (color : blue/orange)
	Other Features	Battery Management APP EC UART to USB, output to the box PC
Physical	Construction Material	ABS+PC plastic with anti-bacterial material
	Mounting	Wall, Stand and Arm VESA 75/100
	Weight (Net)	8.18 kg without batteries 9.53 kg with 3 batteries
	Dimensions (LxWxH)	594.6 x 379.6 x 63.2 mm
Environment	Operating Temperature	0°C – 40°C
	Storage Temperature	-20°C – 60°C
	Humidity	10% to 90% (non-condensing)
	Vibration	1G
	Shock	Operating shock: 5G peak acceleration (11ms duration) Non-operating shock: 10G peak acceleration (11ms duration)
	IP Level	Front: IP65
	Thermal	Fanless
Power	Power Input	19V DC input (4 pin)
	Power Adapter	150W medical power adapter Input: 100V~240V AC Output: 19V DC
Battery	Battery Pack Type	3 x 3S3P cells Lithium-ion Battery (TC-202GA)
	Battery Pack Capacity	3 x 9000 mAh (3 x 97Wh)
	Nominal Voltage	10.8 V
	Battery Life Time	500 cycles (FCC >= 70% of the minimum capacity)
	Charge Voltage	12.6 V
	Maximum Continuous Charge Current	4 A for each battery pack
	Maximum Continuous Discharge Current	5 A for each battery pack
Discharge Cut-off Voltage	9 V	
Certification	EMC & Safety	FCC Part15B EN 62368-1 Ed.2 (60601-1 Compatible) EN 55032 + EN 55035 (60601-1-2 Compatible) Battery Pack: UN38.3, IEC62133, IEC62368-1, UL2054

Ordering Information

Part No.	Description
MPOCm-W24/PC-R10	23.8" 250cd/m ² FHD Medical Monitor, 2 DC output, PCAP touchscreen, supporting up to 3 pcs 9000mAh hot swappable battery pack, w/o battery, R10
MPOCm-W24/PC-1B-R10	23.8" 250cd/m ² FHD Medical Monitor, 2 DC output, PCAP touchscreen, supporting up to 3 pcs 9000mAh hot swappable battery pack, w/ 1 pcs battery, R10
MPOCm-W24/PC-2B-R10	23.8" 250cd/m ² FHD Medical Monitor, 2 DC output, PCAP touchscreen, supporting up to 3 pcs 9000mAh hot swappable battery pack, w/ 2 pcs battery, R10
MPOCm-W24/PC-3B-R10	23.8" 250cd/m ² FHD Medical Monitor, 2 DC output, PCAP touchscreen, supporting up to 3 pcs 9000mAh hot swappable battery pack, w/ 3 pcs battery, R10
MPOCm-W24-R10	23.8" 250cd/m ² FHD Medical Monitor, 2 DC output, supporting up to 3 pcs 9000mAh hot swappable battery pack, w/o battery, R10

IQ Mounting Options

Item	Part No.
Arm	ARM-31-RS
Stand	STAND-A21-R10 (black) STAND-A21W-R10 (white)

Packing List

Item	Q'ty	Remark
Power Adapter	1	150W medical power adapter Input: 90V~264V AC; Output: 19V DC
Power Cord	1	European power cord, 183 cm, C13
32012-003300-100-RS	1	HDMI cable; 1000mm; HDMI A type 19P male
32501-009500-100-RS	1	RF cable; 1000mm; Reverse sma plug
32001-029800-100-RS	1	USB cable; USB 3.0 AM to BM; 1000mm (A) USB 3.0 A type 9P male (B) USB 3.0 B type 9P male
32001-029700-100-RS	1	USB cable; USB 2.0 AM to BM; 1000mm (A) USB A type 4P male (B) USB B type 4P male
43106-0272Q7-00-RS	1	Cable cover for POCm, white, plastic, R10, IEI assembly only

Options

Number	Description
TC-202GA (31603-000106-RS)	3S3P Li-ion battery pack, 10.8V, 9000mAh, CTO only (for eco packing, the order should be at least 14 pcs per box or multiple of 14 pcs)
TC-202GA (MEDP-HSBAT2-R10)	3S3P Li-ion battery pack, 10.8V, 9000mAh with safety shipping BOX (for eco packing, the order should be at least 14 pcs per box or multiple of 14 pcs)
POCm-DOCKING-6BAY-R11	6-slot battery charger, LED indicator, 15V/300W power adapter



TC-202GA (31603-000106-RS)



TC-202GA (MEDP-HSBAT2-R10)



POCm-DOCKING-6BAY-R11