

TANK-XM811

- High-Performance 12th/13th Generation Intel® Core™ Processor
- Fanless Embedded Computer



Features

- Supported CPUs:
 - Intel® Core™ i5-12500TE 1.9 GHz (up to 4.3 GHz, 6-core, 35W TDP)
 - Intel® Core™ i7-12700TE 1.4 GHz (up to 4.6 GHz, 12-core, 35W TDP)
 - Intel® Core™ i9-12900TE 1.1 GHz (up to 4.8 GHz, 16-core, 35W TDP)
- 2 x 2.5G Ethernet ports
- Multiple USB ports and serial ports
- Multiple internal expansion boards for flexible selection
- Various optional backplanes and chassis
- CE/FCC compliant

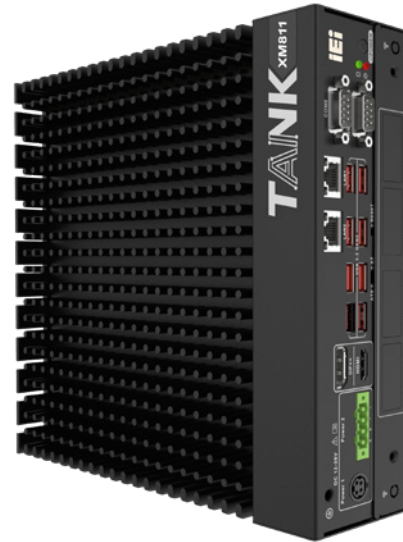

Specifications

Model Name		TANK-XM811
Chassis	Color	Black C
	Dimensions (WxDxH) (mm)	230.6 x 256.04 x 76.2
	System Fan	Fanless
	Chassis Construction	Extruded aluminum alloys
Motherboard	CPU	12 th /13 th Gen Intel® Core™ CPU 35/65W TDP Intel® Core™ i5-12500TE 1.9 GHz (up to 4.3 GHz, 6-core, 35W TDP) Intel® Core™ i7-12700TE 1.4 GHz (up to 4.6 GHz, 12-core, 35W TDP) Intel® Core™ i9-12900TE 1.1 GHz (up to 4.8 GHz, 16-core, 35W TDP)
	Chipset	R680E
	Memory	2 x SO-DIMM DDR4 3200 (8GB pre-installed) (up to 64GB)
Storage	HDD Bay	1 x 2.5" SATA 6Gb/s HDD/SSD bay
I/O Interfaces	Ethernet	1 x 2.5 GbE by Intel® I225LM/I226LM controller 1 x 2.5 GbE by Intel® I225-V/I226-V controller
	USB 3.2 Gen 2 (10Gb/s)	8
	COM	2 x RS-232/422/485, 4 x RS-232
	Digital I/O	12-bit (6-in/6-out) DB15
	Display Interface	1 x DP++, 1 x HDMI™
Internal Expansions	M.2	1 x 2280 M-key (PCIe Gen4 x4) 1 x 2230 A-key (USB+PCIe Gen3 x1, supports vPRO)
	Expansion Backplane	Optional
Power	Power Input	12 ~ 28V DC
	Remote Power	1 x 2-pin
	Power Consumption	12V @ 8.8A (Intel® Core™ i9-12900TE with 16GB memory)
Reliability	Mounting	Wall mount
	Operating Temperature	-20°C ~ 60°C with air flow (CPU TDP35W &SSD) -20°C ~ 50°C with air flow (CPU TDP65W &SSD), 10% ~ 95% non-condensing
	Storage Temperature	-40°C ~ 85°C, 10% ~ 95%, non-condensing
	Operating Shock	Half-sine wave shock 5G, 11ms, 100 shocks per axis (SSD)
	Operating Vibration	MIL-STD-810G 514.6C-1 (with SSD)
	Weight (Net/Gross)	3.33/3.7 kg
	Safety / EMC	CE, FCC, UKCA
Watchdog Timer	Programmable 1 ~ 255 sec/min	
OS	Supported OS	Windows® 10/11 IoT Enterprise/ Linux

Modular Design, Easy to Install

The mainboard is secured to the support bracket to prevent PCB from bending or warping. The three-layer structure consisting of heat spreader, mainboard and baseboard makes it easier to install CPU, memory and HDD, compared with the former TANK series.

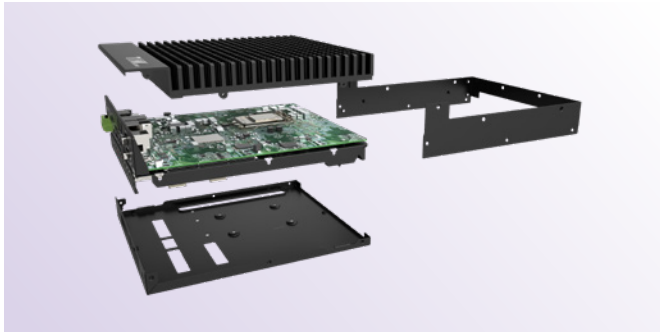

Support High-performance Graphics Card

With IEI power board, it can support 3060 and other advanced graphics cards.

Maximum length of graphics card supported:350mm

*Specified power adapter is required.

NVIDIA 3060

*Support advanced graphics card



Flexible Expansion

Different expansion requirements can be met. Dual-slot and four-slot SKUs are provided for selection. Customers can choose the type of expansion slot according to their needs.



External Fan

Installing an external fan helps to increase system performance in harsh environment.

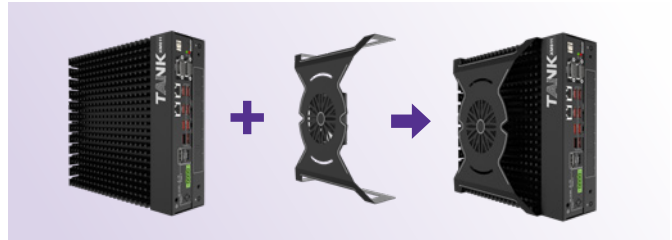

Fully Integrated I/O

Top View

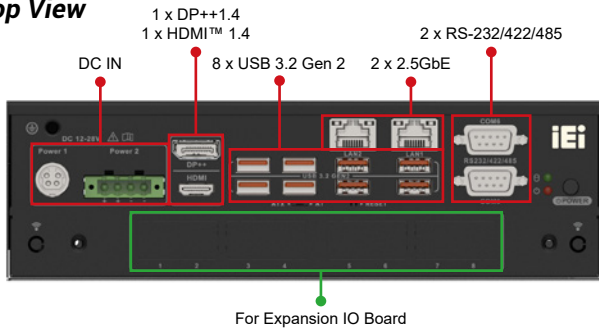

Front View

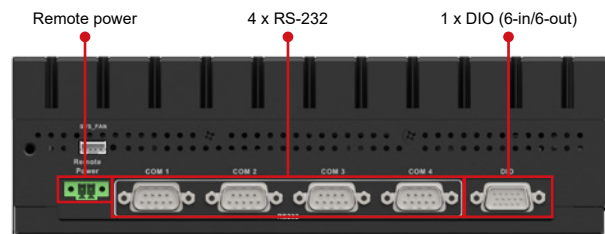

Modular Board Design

It supports various optional modules, such as M.2 expansion card, 8-port PoE expansion card, etc.

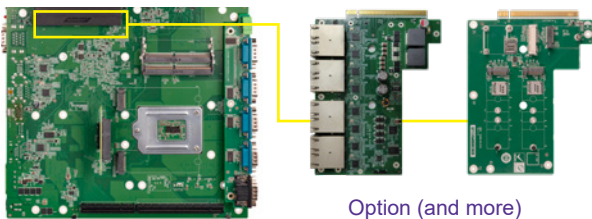

Option (and more)

Expansion IO Board	
GPOE-XM81-8P-R10	I/O expansion module for TANK 81 series, 8 x 2.5G LAN with PoE
TXIOB-XM81-A-R10	I/O expansion module for TANK 81 series, 2 x M.2 B Key, 1 x M.2 A Key, 1 x PCIe Mini

Support 35W & 65W CPU

Operating temperature:	
With 35w CPU (or 65W CPU PL1 & PL2, default 35W):	-20°C ~ 60°C
With 65w CPU:	-20°C ~ 50°C

Dimensions (Unit: mm)

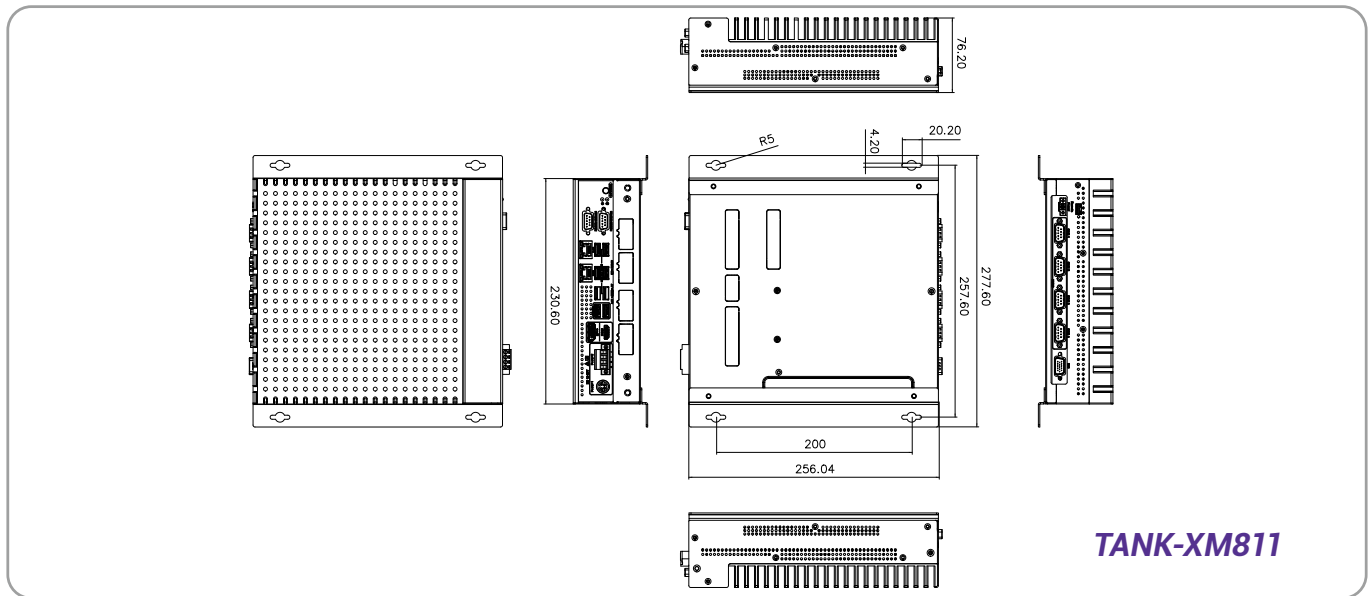

Ordering Information

Model	Description
TANK-XM811-i5AC-R10	Ruggedized Fanless Embedded System with Intel® Core™ i5, 8GB RAM, 1 x HDMI™, 1 x DP++, 12~28V DC and RoHS
TANK-XM811-i7AC-R10	Ruggedized Fanless Embedded System with Intel® Core™ i7, 8GB RAM, 1 x HDMI™, 1 x DP++, 12~28V DC and RoHS
TANK-XM811-i9AD-R10	Ruggedized Fanless Embedded System with Intel® Core™ i9, 16GB RAM, 1 x HDMI™, 1 x DP++, 12~28V DC and RoHS

Options

Part No.	Description
EMB-WIFI-KIT0213-R10	2T2R M.2 wifi module kit for embedded system, IEEE802.11a/b/g/n/ac/ax, 1 x M.2 AE Key Wireless LAN & Bluetooth 5.2; Intel; AX210.NGWG Module, 2 x RF cable, 2 x Antenna; RoHS
63040-010180-200-RS	Adapter Power; FSP; FSP180-ABAN3; 9NA1804008; Active PFC; Vin: 90~264VAC; 180W; Dim: 75.6*151.3*25.4mm; Plug=6.5mm; Cable=1500mm; Erp(NO LOAD 0.5W); Vout: 19VDC; Din 4Pin/lock; CCL; RoHS
32702-000202-100-RS	POWER CORD; EUROPEAN CODE(VDE); 1000mm; 300V; (A)PLUG:SH-005(16A/250V); (B)CONNECTOR:C13(SH-006, 10A/250V)
SF-TANK-XM81-R10	External fan for TANK-XM81 Series
TANK-XM811-W10IoT21-H-R10	OS Image with Windows® 10 Enterprise High End 64-bit 2021 for TANK-XM811-i7 & i9 Series, with DVD-ROM, RoHS
TANK-XM811-W10IoT21-V-R10	OS Image with Windows® 10 Enterprise Value 64-bit 2021 for TANK-XM811-i3 & i5 Series, with DVD-ROM, RoHS

Optional Expansion Backplane

Part No.	Description
TXCBP-XM81-2A-R10	Expansion backplane module for TANK 81 Series, 2 slot, 1 x PCIe x16 & 1 x PCIe x4
TXCBP-XM81-2B-R10	Expansion backplane module for TANK 81 Series, 2 slot, 2 x PCIe x8
TXCBP-XM81-4A-R10	Expansion backplane module for TANK 81 Series, 4 slot, 1 x PCIe x16 & 2 x PCIe x4 & 1 x PCIe x1 w/ external power supply
TXCBP-XM81-4B-R10	Expansion backplane module for TANK 81 Series, 4 slot, 2 x PCIe x8 & 2 x PCIe x4 w/ external power supply
TXCBP-XM81-4C-R10	Expansion backplane module for TANK 81 Series, 4 slot, 1 x PCIe x16 & 2 x PCI & 1 x PCIe x4
TXCBP-XM81-G2-PW-R10	Expansion backplane module for TANK 81 Series, 6 slot, 2 x PCIe x8 & 2 x PCIe x4 w/ external power supply
IDD-X1228150-R10*	Extended Power Board for TANK-XM81 Series, 150W@16~28V or 380W@12V DC input 12V output Power Module

* For expansion cards (graphics cards, accelerator cards) that require independent power supply to provide independent power supply, it must be equipped with a Backplane with W/external power supply function.

Optional Expansion Chassis

Part No.	Description
TXC-XM81-3S-R10	3-slot expansion chassis for TANK 81 Series
TXC-XM81-4S-R10	4-slot expansion chassis for TANK 81 Series
TXC-XM81-G1-R10	One GPU expansion chassis for TANK 81 Series
TXC-XM81-G2-R10	Dual GPU expansion chassis for TANK 81 Series

Optional Internal Expansion Boards

Part No.	Description
GPOE-XM81-8P-R10	I/O expansion module for TANK 81 Series, 8 x 2.5G LAN with PoE
TXIOB-XM81-A-R10	I/O expansion module for TANK 81 Series, 2 x M.2 B Key, 1 x M.2 A Key, 1 x PCIe Mini

Packing List

1 x Screw pack	2 x Terminal block	1 x Mounting bracket
----------------	--------------------	----------------------