

PICMG 1.3 Passive Backplane

Selection Guide

PAC series wall-mount chassis

4U/5U rack-mount chassis

1U/2U rack-mount chassis

PICMG 1.3 (PCIe+PCI)	Model	PE-2SD1	PE-3S1	PE-4S	PE-5S	PE-5S2	PE-6S	PE-6S2	PE-6SD	PE-6SD3
Total Slot		2	5	4	5	5	6	6	5	5
Expansion Slots	PCIe Slots	x16 *	1 (Gen 2.0)	1 (Gen 3.0)	1	1 (Gen 2.0)	1 (Gen 2.0)	1 (Gen 2.0)	1 (Gen 2.0)	1 (Gen 2.0)
		x4	-	1 (Gen 3.0)	1	1 (Gen 2.0)	-	1 (Gen 2.0)	-	1 (Gen 2.0)
	x1	-	-	-	-	3 (Gen 2.0)	2 (Gen 2.0)	-	3 (Gen 2.0)	-
	PCI-X Slots	-	-	-	-	-	-	-	-	-
PCI Slots	-	-	1	2	-	2	3	-	-	2
USB Connectors by Pin Header		4	-	4	4	4	4	4	4	4
PSU Type		24+4-pin ATX	24+4-pin ATX	24+4-pin ATX	24+4-pin ATX	24+4-pin ATX	24+4-pin ATX	24+4-pin ATX	24+4-pin ATX	24+4-pin ATX
Chassis		RACK-1150-PE	RACK-500AI	N/A	N/A	N/A	RACK-305G RACK-360G RACK-3000G PAC-1700G PAC-125 G	PAC-106G PAC-1000G	N/A	N/A
Note		1U Type							2U Type	2U Type

PICMG 1.3 (PCIe+PCI)	Model	PE-7S	PE-8S	PE-9S	PE-10S	PE-10S2	PXE-11S1	PXE-13S	PXE-14S1
Total Slot		7	8	9	10	10	11	13	14
Expansion Slots	PCIe Slots	x16 *	1 (Gen 2.0)	1 (Gen 2.0)	1 (Gen 2.0)	1 (Gen 2.0)	1 (Gen 2.0)	1 (Gen 3 x8)	1 (Gen 3.0)
		x4	-	-	-	-	-	3 (x4 signal)+ 1 (x2 signal)	-
	x1	2 (Gen 2.0)	3 (Gen 2.0)	4 (Gen 2.0)	4 (Gen 2.0)	4 (Gen 2.0)	1	3 (Gen 3.0)	-
	M.2 Slot	-	-	-	-	-	1 (M.2 A key)	-	-
PCI Slots	3	3	3	4	4	4	8	12	
USB Connectors by Pin Header		4	4	4	4	4	-	4	-
PSU Type		24+4-pin ATX	24+4-pin ATX	24+4-pin ATX	24+4-pin ATX	24+4-pin ATX	24+4-pin ATX	24+4-pin ATX	24+4-pin ATX
Chassis		PAC-1700G	PAC-125G	N/A	RACK-305G RACK-360G RACK-3000G	RACK-3000G RACK-305G RACK-360G	RACK-305G RACK-360G	RACK-3000G RACK-305G RACK-360G	RACK-305G RACK-360G
Note								PCIe to PCI Bridge Backplane	

*When using a PCIe x16 add-on card, the length of the card must not exceed 167mm or 6.57 inches.

IEI Graphics Grade Backplane Solution

The graphics grade backplane solution targets the applications which concern system speed and performance. It has higher performance over cost ratio than the previous PICMG 1.0 solution.

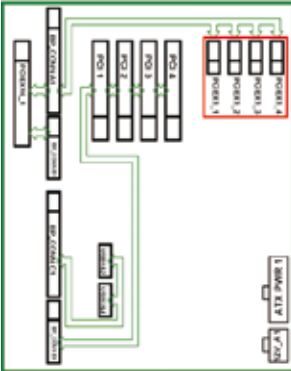
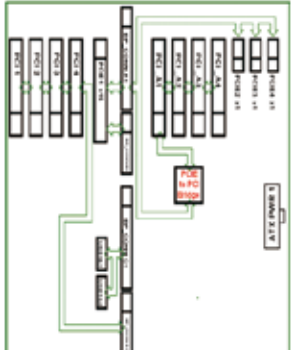
PE-3S1



PE-4S



PE-5S



PE-6S2



PE-9S



PE-10S



PE-10S2

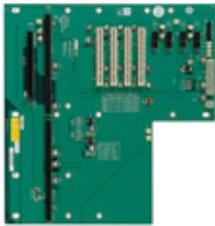

PXE-11S1



PXE-13S

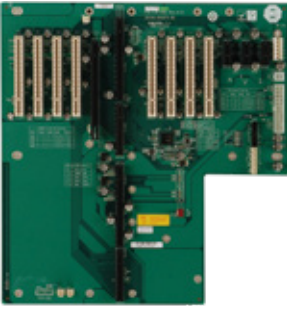

PXE-14S1

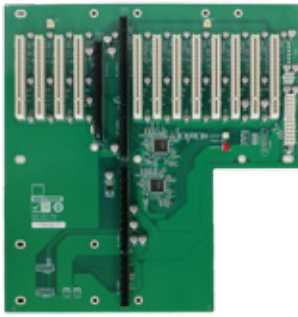

- Twenty PCIe lanes in total
- One PCIe x16 slot
- Up to four PCIe x1 or one PCIe x4 slot
- Up to four local PCI slots (w/o bridge)

PE-2SD1-R10

For 1U system!

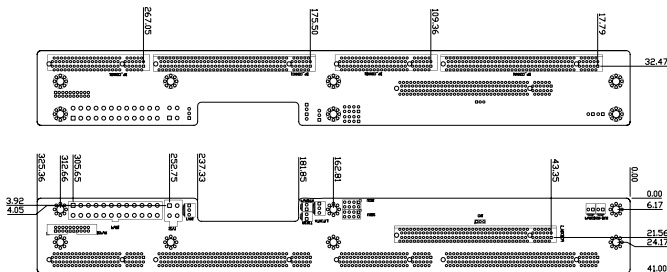
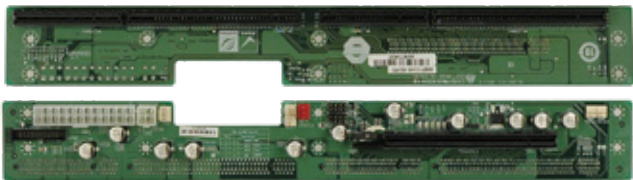

Ordering Information

PE-2SD1-R10 2-slot backplane with one PCIe slot (PCIe Gen 2.0)
 RACK-1150G-PE 1U full-size rack-mount chassis

PE-3S1-R10

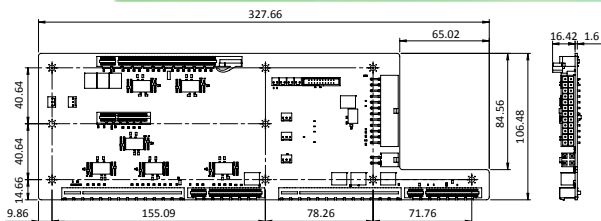

Ordering Information

PE-3S1-R10 5-slot PICMG 1.3 backplane with one PCIe x16 slot and one PCIe x4 Slot, RoHS (PCIe Gen 3.0)
 RACK-500AI 5U 5-slot full-size rackmount chassis

PE-4S-R40

Mounting holes compatible with PCI-4S

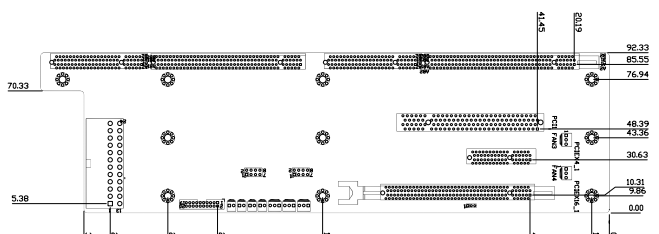

Ordering Information

PE-4S-R40 4-slot backplane with one PCIe x16 slot, one PCIe x4 slot and one PCI slot

PE-5S-R40

Mounting holes compatible with PCI-5S

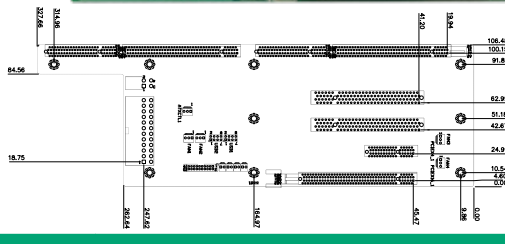

Ordering Information

PE-5S-R40 5-slot backplane with one PCIe x16 slot, one PCIe x4 slot and two PCI slots (PCIe Gen 2.0)

PE-5S2-R40

Mounting holes compatible with PCI-5S

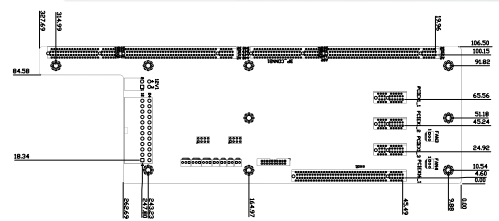

Ordering Information

PE-5S2-R40 5-slot backplane with one PCIe x16 slot and three PCIe x1 slots (PCIe Gen 2.0)

PE-6S-R41

Mounting holes compatible with PCI-7S

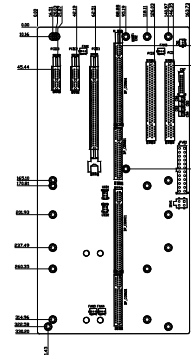
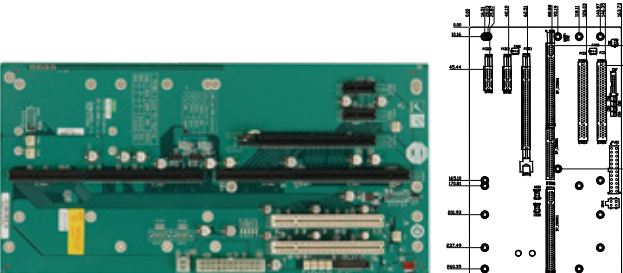

Ordering Information

PE-6S-R41 6-slot backplane with one PCIe x16 slot, two PCIe x1 slots and two PCI slots (PCIe Gen 2.0)
 RACK-305G 4U 14-slot full-size rack-mount chassis
 RACK-360G 4U 14-slot full-size rack-mount chassis
 RACK-3000G 4U 14-slot full-size rack-mount chassis
 PAC-1700G 7-slot full-size compact chassis
 PAC-125G 10-slot full-size compact chassis

PE-6S2-R40

Mounting holes compatible with PCI-6S

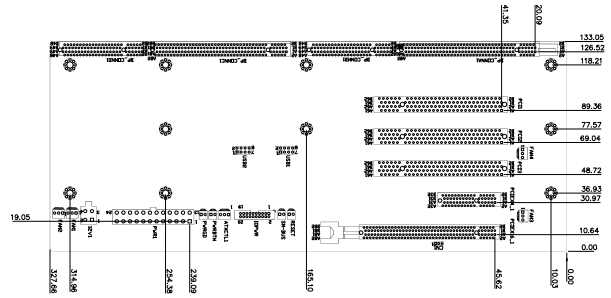
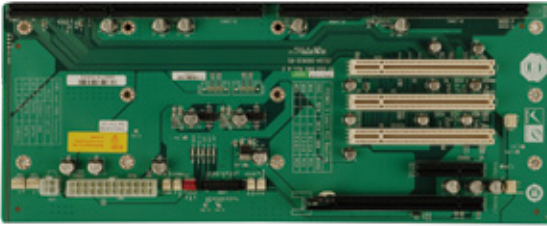

Ordering Information

PE-6S2-R40	6-slot backplane with one PCIe x16 slot and three PCI slots (PCIe Gen 2.0)
PAC-106G *	6-slot full-size compact chassis
PAC-1000G	6-slot full-size compact chassis

* When using a PCIe x16 add-on card, the length of the card must not exceed 167mm or 6.57 inches.

PE-6SD-R40

Mounting holes compatible with PCI-6SD

2U Type

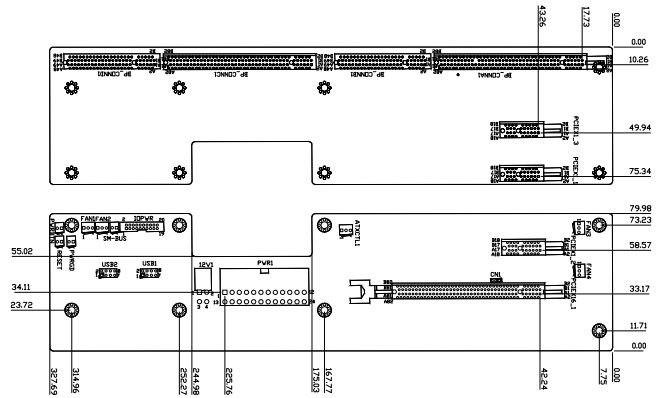
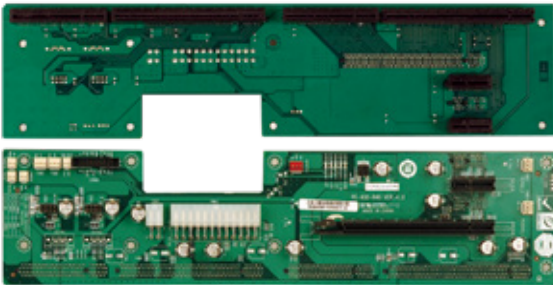

Ordering Information

PE-6SD-R40	5-slot backplane with one PCIe x16 slot and three PCIe x1 slots (PCIe Gen 2.0)
------------	--

PE-6SD3-R40

Mounting holes compatible with PCI-6SD

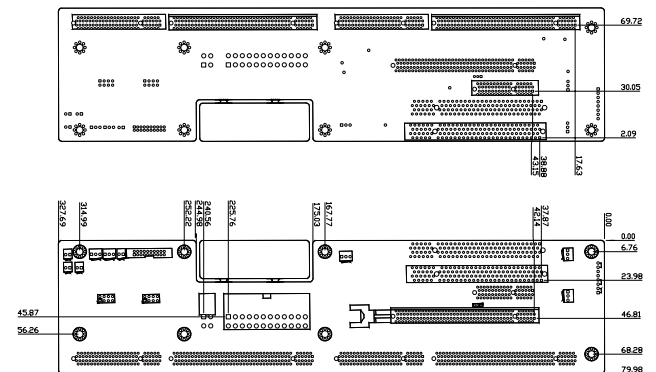
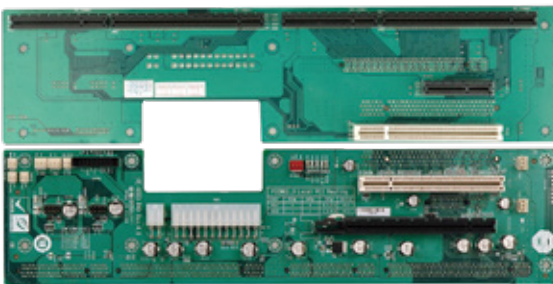

Ordering Information

PE-6SD3-R40	5-slot backplane with one PCIe x16 slot, one PCIe x4 slot and two PCI slots (PCIe Gen 2.0)
-------------	--

PE-7S-R40

Mounting holes compatible with PCI-7S

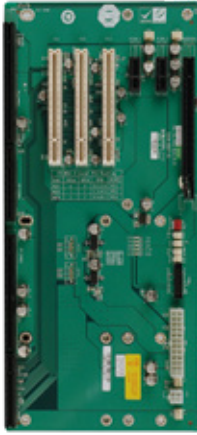

Ordering Information

PE-7S-R40	7-slot backplane with one PCIe x16 slot, two PCIe x1 slots and three PCI slots (PCIe Gen 2.0)
PAC-1700G	7-slot full-size compact chassis

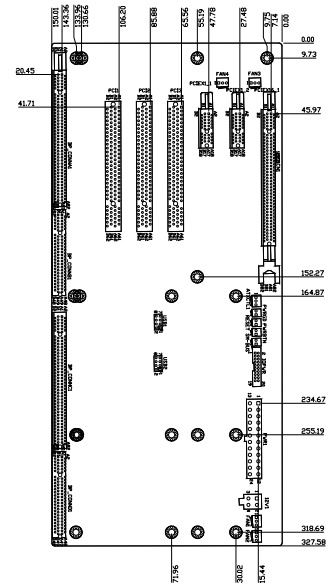

PE-8S-R40

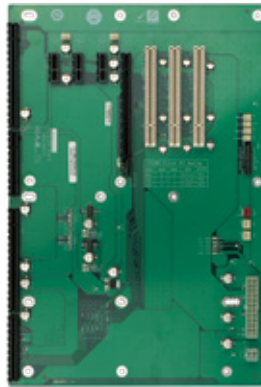

Ordering Information

PE-8S-R40	8-slot backplane with one PCIe x16 slot, three PCIe x1 slots and three PCI slots (PCIe Gen 2.0)
PAC-125G	10-slot full-size compact chassis

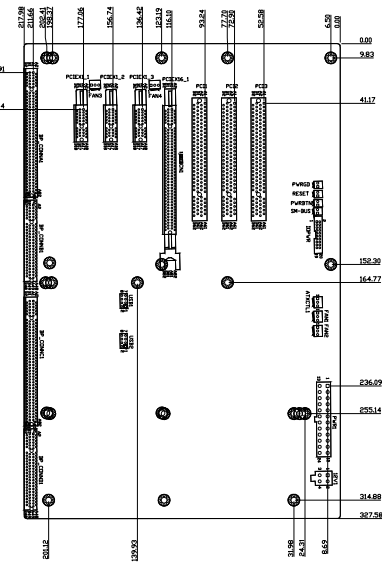

PE-9S-R40

Mounting holes compatible with PCI-10S2

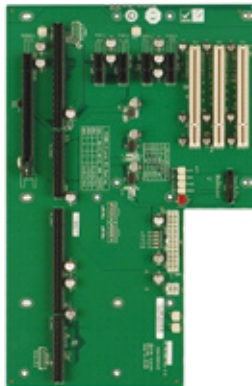

Ordering Information

PE-9S-R40	9-slot backplane with one PCIe x16 slot, four PCIe x1 slots and three PCI slots (PCIe Gen 2.0)
-----------	--

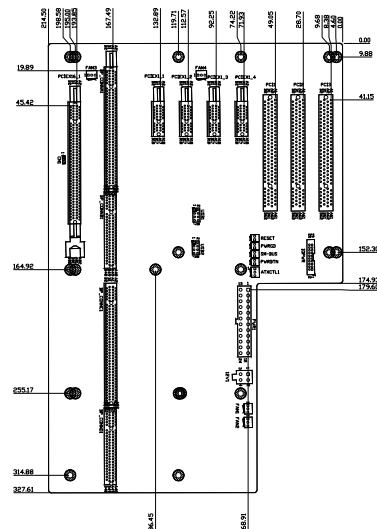

PE-10S-R40

Mounting holes compatible with PCI-14S

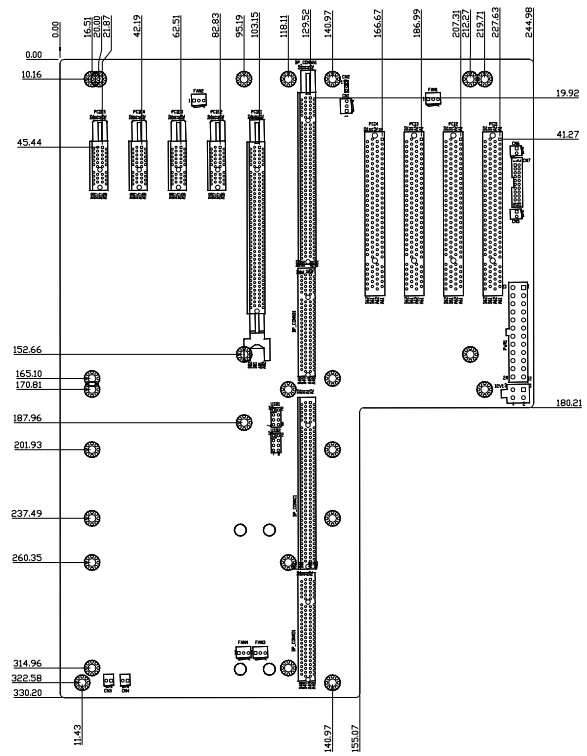
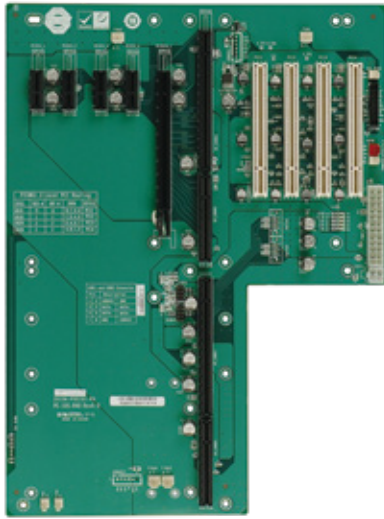

Ordering Information

PE-10S-R40	10-slot backplane with one PCIe x16 slot, four PCIe x1 slots and four PCI slots (PCIe Gen 2.0)
RACK-305G	4U 14-slot full-size rack-mount chassis
RACK-360G	4U 14-slot full-size rack-mount chassis
RACK-3000G	4U 14-slot full-size rack-mount chassis

PE-10S2-R40

Mounting holes compatible with PCI-14S

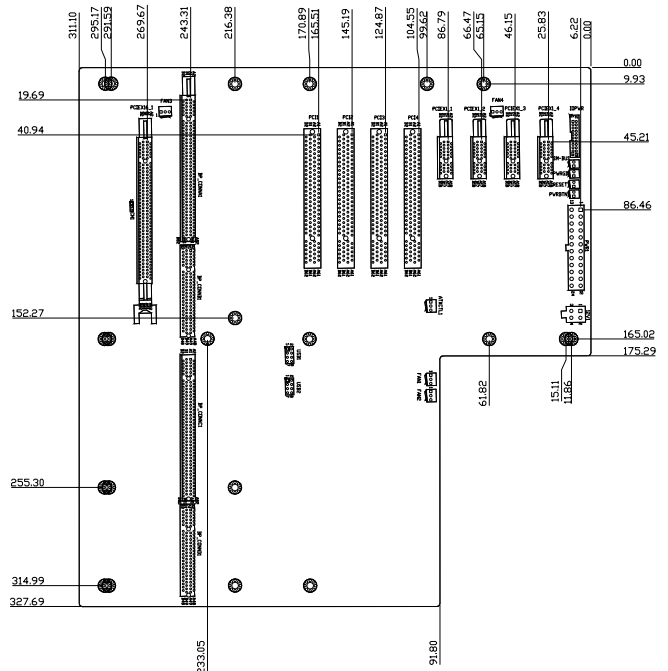
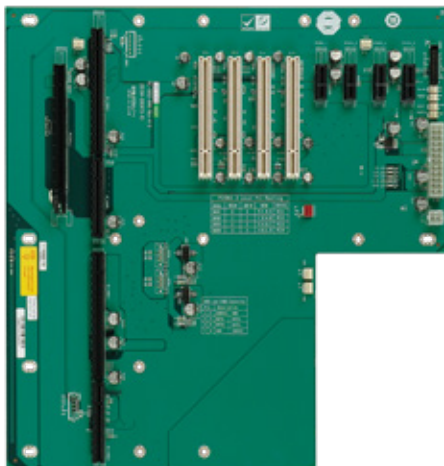

Ordering Information

PE-10S2-R40	10-slot backplane with one PCIe x16 slot, four PCIe x1 slots and four PCI slots (PCIe Gen 2.0)
RACK-3000G	4U 14-slot full-size rack-mount chassis
RACK-305G	4U 14-slot full-size rack-mount chassis
RACK-360G	4U 14-slot full-size rack-mount chassis

PXE-11S1-R10

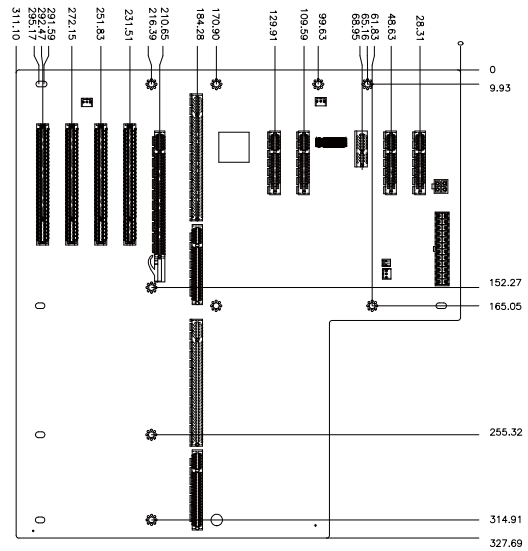

Ordering Information

PXE-11S1-R10	PICMG 1.3 ,11 Slots Backplane with one PCIe x16, one PCIe x1, four PCIe x4(x2 signal) and four PCI Slots,RoHS
RACK-305G	4U 14-slot full-size rack-mount chassis
RACK-360G	4U 14-slot full-size rack-mount chassis

PXE-13S-R51

Mounting holes compatible with PCI-14S (PCIe to PCI Bridge)

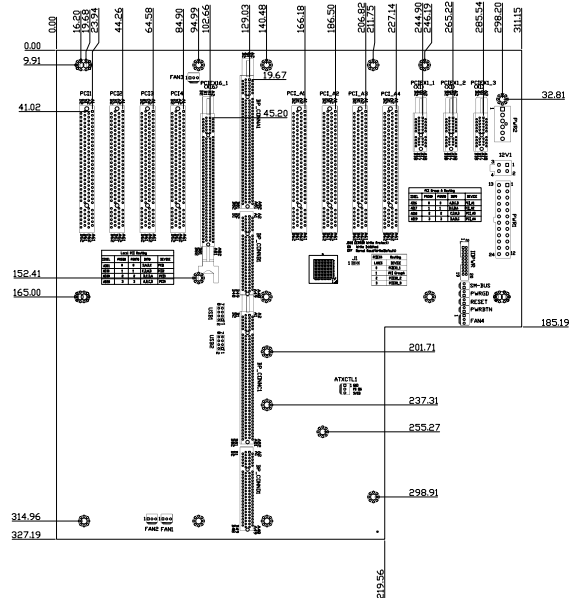
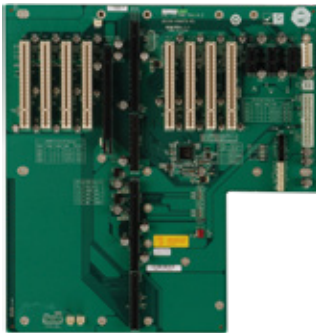

Ordering Information

PXE-13S-R51	13-slot backplane with one PCIe x16 slot, three PCIe x1 slots and eight PCI slots (PCIe Gen 3.0)
RACK-3000G	4U 14-slot full-size rack-mount chassis
RACK-305G	4U 14-slot full-size rack-mount chassis
RACK-360G	4U 14-slot full-size rack-mount chassis

PXE-14S1-R10

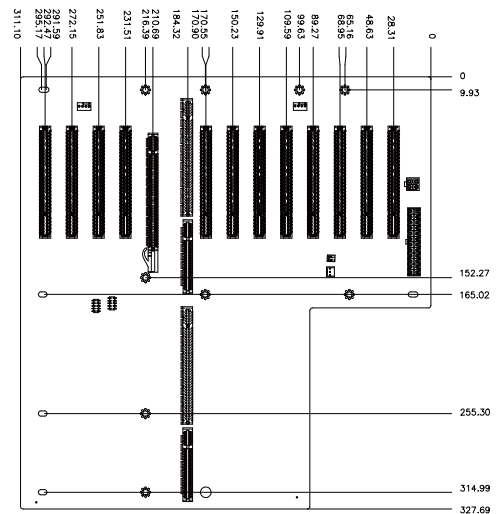
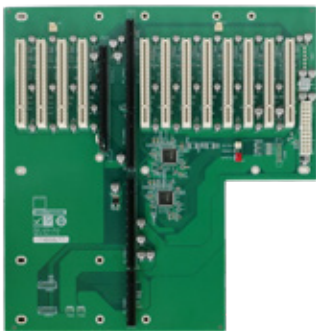

Ordering Information

PXE-14S1-R10	PICMG 1.3 ,14 Slots Backplane with one PCIe x16 and twelve PCI Slots,RoHS
RACK-305G	4U 14-slot full-size rack-mount chassis
RACK-360G	4U 14-slot full-size rack-mount chassis