

UPC Series

UPC-V315-QM77

Intel® Mobile QM77 Express Chipset



Features

- Intel® Ivy Bridge mobile chipset
- 15" 400 nits 1024 x 768 LCD with LED backlight
- Full IP 65 compliant die-casting aluminum chassis
- PCIe Mini card expansion
- Dual-DC input, 9V ~ 36V and 10.5V ~ 36V, switch automatically
- ACC power support
- Dual-band 2.4/5 GHz Wi-Fi 802.11a/b/g/n 3T3R MIMO design
- Reserved space for 3.75G HSUPA USB dongle
- Optional GPS receiver
- Optional EM or Mifare RFID reader
- Optional Bluetooth module
- Built-in 2-megapixel webcam with AF, AE and AWB capabilities
- CAN-bus interface with isolation
- F1 ~ F10 function keys with customization options



» **Various Connection Options**

The UPC-V315 provides different kinds of communication interfaces, such as LAN/ WLAN/3G/GPS/Bluetooth/ RFID, which maximize flexibility of system integration and ensure seamless workflow.

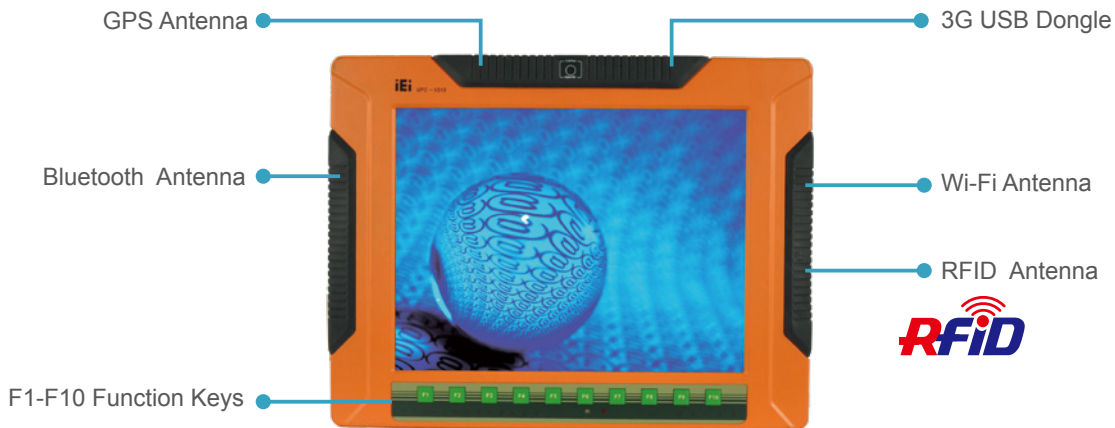

Connection Feasibility



Dual-Band 2.4/5 GHz Wi-Fi

Dual-band 2.4/5 GHz 802.11a/b/g/n 3T3R MIMO design with up to 450 Mbps speed



3.75G HSUPA (optional)

Comparing to wireless network, 3.75G HSUPA has higher mobility with long-range mobile communication and no hotspot limitation. It is also able to connect to the Internet in real time.



Bluetooth V2.1+EDR (optional)

Connect peripheral devices with Bluetooth, such as earphone, scanner, etc.



GPS (optional)

Travel navigation, real-time locating and path tracking

» Robust Mechanical Design

The UPC-V315 is fully IP65 protected with aluminum chassis and water proof rubber gaskets. It also supports wide operating temperature from -20°C to 60°C.



Note: Power adapter supports operating temperature 0°C to 40°C.



» PCIe Mini Card Expansion

A. 3T3R Wi-Fi Module

UPC-V315 supports IEEE 802.11a/b/g/n 3T3R Wi-Fi module, enhancing the transmission speed and coverage.

T: Transmitter
The number T is absolutely relative with speed, 1T up to 150Mbps, 2T up to 300Mbps, 3T up to 450Mbps.

R: Receiver
The number R is relative with receiving dead angle and distance. The higher R is, the wider the receiving range.

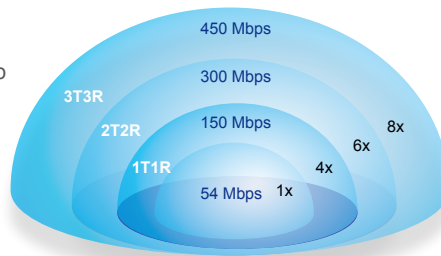

B. Solid State Disk mSATA

mSATA is compact, rugged, and much faster than traditional HDD, which is suitable for harsh environment.



C. 4-Channel Capture Card

The UPC-V315-QM77 supports 4-channel video capture solution via PCIe Mini card, which can easily integrate IP camera for surveillance and real-time video streaming.

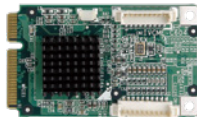

IVCME-C604



QM77 Only

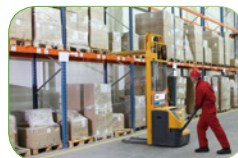

Forklift Management



Slaughter House Factory



Flower Market Management

» CAN-bus Interface with Isolation

The Control Area Network (CAN) is a serial bus system. The UPC-V315 on-board CAN controllers provide bus arbitration and error detection with automatic transmission repeat function. This drastically reduces the chance of data loss, ensures system reliability, and is suitable for network intelligent I/O devices such as sensors or actuators of machines or plants.

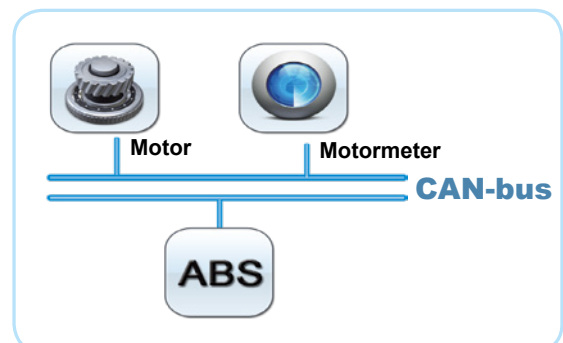

1. Isolated protection voltage 2500V/min DC protection
2. Typical transient immunity 50 kV/ms ESD protection

» AUPS Network Administration Tool

Intelligent Software Utility

The remote management software utility and application program allow users to easily get the status of the AUPS and to control the AUPS power functions from anywhere with internet connection.



Network Remote Management Software Battery Capacity Status

UPS Status Monitoring

Stack Version: v1.3
Build Date: May 10 2018 00:08:00

- STATUS** - display UPS status and change UPS ON/OFF
- Send E-mail** - Send UPS status with E-MAIL
- Configuration** - setup IP Address and enable DHCP...

Power On/OFF

(click to toggle)
UPS ON/OFF:
 ON
 OFF
OS Shut Down:
 Yes
 No

AUPS

Stack Version: v1.3
Build Date: May 10 2018 00:08:00

- STATUS** - display UPS status and change UPS ON/OFF
- Send E-mail** - Send UPS status with E-MAIL

"Battery 1":
STATUS: Charging
Capacity(%): 87
VOLTAGE(mV): 12175
Current(mA): 2454
Temperature(C): 35
RemainTime(min): Not Used

Remote control DC output ON/OFF via web interface.

» AUPS Local USB Utility Tool

Monitor the Most Critical Battery Functions on the Local Machine

The battery monitoring utility provides AUPS status monitoring and configuration ability. Uninterruptible Power Systems is a significant product that serves as emergency power when you suffer from electric event.



MONITORING SYSTEM STATUS

Shows system status real-time monitoring

- DC Power indicator
- Battery capacity
- Battery status
- Temperature



BATTERY STATUS

Shows battery status real-time monitoring

- Real-time information update
- Status bar



LAN CONFIGURATION

LAN shows system IP Address information



E-MAIL

The E-mail page is where to set the SMTP settings for sending alert notification via e-mail



SETTING

Setting system management

Buzzer	Enable or disable the buzzer that warns when the system is switching to use battery power.
Enable LAN	Enable or disable the LAN for remote monitoring function.
Power	Click the button to power off the AUPS power module immediately.
Auto DC on	Enable to automatically power on the AUPS once DC power is applied.
Shut down condition (capacity %)	Set the battery capacity parameter for the system to shut down automatically.
DC off delay time (0-65536 sec)	Set the delay time for the AUPS series to power off after the system shut down.
System will be down-converted (capacity %)	Set the battery capacity parameter for the system to automatically switch to the Balanced power plan set in its Windows OS.
System go to sleep mode (capacity %)	Set the battery capacity parameter for the system to go into sleep mode automatically.

Specifications

Model		UPC-V315-QM77
Display	LCD Size	15 "
	Max. Resolution	1024(W) x 768(H)
	Brightness (cd/m ²)	400
	Contrast Ratio	700:1
	LCD Color	16.2M
	Pixel Pitch (mm) (HxV)	0.297(H) x 0.297(V)
	Viewing Angle (V/H)	125°/ 140°
	Backlight MTBF (hrs)	50000
Touch	Touchscreen	5-wire resistive type with RS-232 interface
	Touch Controller	DMC 9000
Motherboard	CPU	Intel® Celeron® 1047UE processor Intel® Core™ i7-3517UE processor Intel® Core™ i3-3217UE processor
	Chipset	Mobile Intel® QM77 Express Chipset
	RAM	Built-in one 2 GB DDR3 memory (system max. 8GB; on board max. 4GB, socket max. 4GB)
	Ethernet	Intel® WG82579LM GbE PHY
	Audio Codec	Realtek ALC892 HD audio codec
I/O Ports and Switches		3 x RS-232 (RJ-45) 1 x RS-422/485 (RJ-45) 1 x CAN-bus 1 x VGA 1 x HDMI port 2 x GbE LAN 2 x USB 2.0 2 x USB 3.1 Gen 1 (5Gb/s) 1 x Reset button 1 x Audio jack (Line out, MIC) 1 x DC jack (9~36V DC) 1 x Terminal block (9~36V DC) 1 x AT/ATX mode switch
System	Audio	AMP 3W + 3W (internal speaker)
	Camera	2-megapixel
Connectivity	Wireless	IEEE 802.11a/b/g/n 3T3R module (WIFI-RT5393-DB-R10) Telec certified
	Bluetooth	Bluetooth V2.0+EDR with USB interface (optional)
	3G	Reserved USB connector (optional)
	GPS	FV-W9U (optional, internal USB header)
Drive Bay	HDD Driver Bay	1 x 2.5" SATA SSD bay
	SSD	mSATA (SATA2 signal)
	CD-ROM Driver Bay	N/A
Expansion Slot		1 x PCIe Mini card
System Cooling		Fanless
Physical	Construction Material	Aluminium alloy
	Mounting	VESA 100mm x100mm or 75mm x 75mm with M8 screws
	Front Panel Color	Orange (Pantone 15C)
	Dimensions (WxHxD) (mm)	427.19 x 330.63 x 77.06
	Net Weight	7.97 kg
Environment	Operating Temperature	-20°C ~ 60°C
	Storage Temperature	-30°C ~ 70°C
	Operating Humidity	5% ~90%, non-condensing
	Shock	Half-sine wave shock 3G; 11ms; 3 shocks per axis
	Vibration	MIL-STD-810F 514.5C-1 (with SSD)
	IP Rating	Full IP 65
Power	Adapter	90 W ; 63040-010090-101-RS
	Requirement	Power 1: 9V~36V(+/-0.3V) Power 2: 10.5V~36V(+/-0.3V)

Ordering Information

P/N	Description
UPC-V315-QM77-C/R/2G-R20	15" 400cd/m ² XGA fanless full IP65 panel PC with mobile Intel® QM77 Express Chipset and Intel® Celeron® dual-core 1047UE processor (2M cache, 1.40 GHz), TDP 17W, 802.11a/b/g/n wireless module, resistive touchscreen, 2M camera, microphone, 2GB DDR3 RAM, R20
UPC-V315-QM77-I3/R/2G-R20	15" 400cd/m ² XGA fanless full IP65 panel PC with mobile Intel® QM77 Express Chipset and Intel® Core™ i3-3217UE processor, 802.11a/b/g/n wireless module, resistive touchscreen, 2-mgeapixel camera, microphone, 2GB DDR3 RAM, R20
UPC-V315-QM77-I7/R/2G-R20	15" 400cd/m ² XGA fanless full IP65 panel PC with mobile Intel® QM77 Express Chipset and Intel® Core™ i7-3517UE processor, 802.11a/b/g/n wireless module, resistive touchscreen, 2-mgeapixel camera, microphone, 2GB DDR3 RAM, R20

Packing List

Item	P/N	Q'ty
IR Remote Controller	7Z000-SLPCB005-RS	1
RJ-45 to DB-9 COM Port Cable	32005-000200-200-RS	4
M8 Screw	44325-080081-RS	8
M4 Screw	44005-040082-RS	8
Mounting Bracket	41003-0433C2-00-RS	2
Screw Driver	45019-001004-00	1
Power Adapter	63040-010090-101-RS	1
Power Cord (European Standard)	32702-000401-100-RS	1
Power Transfer Cord	32702-000300-100-RS	1
M8 to M4 Screw	44300-040061-RS	8

Options

Item	P/N
Arm	ARM-31-RS
Wall Mounting Kit	AFLWK-19B
Stand	STAND-C19-R10/STAND-100/STAND-210
EM RFID Kit	UPC-EM-RFID-KIT01-R10
Mifare RFID Kit	UPC-MF-RFID-KIT01-R11
OS: Win XPE (CD-ROM)	UPC-V315-XPE-R10
OS: Win 7 Embedded (DVD-ROM)	UPC-V315-W7E-R10

IO and Human Machine Interface

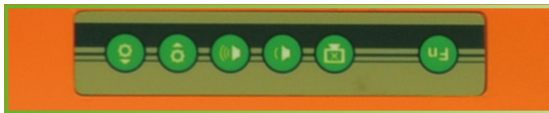

Fn		RFID enable / disable
Backlight On/Off	Fn +	Audio mute
Audio -	Fn +	Camera enable / disable
Audio +	Fn +	Right side USB enable / disable
Brightness -	Fn +	Power on / off
Brightness +	Fn +	

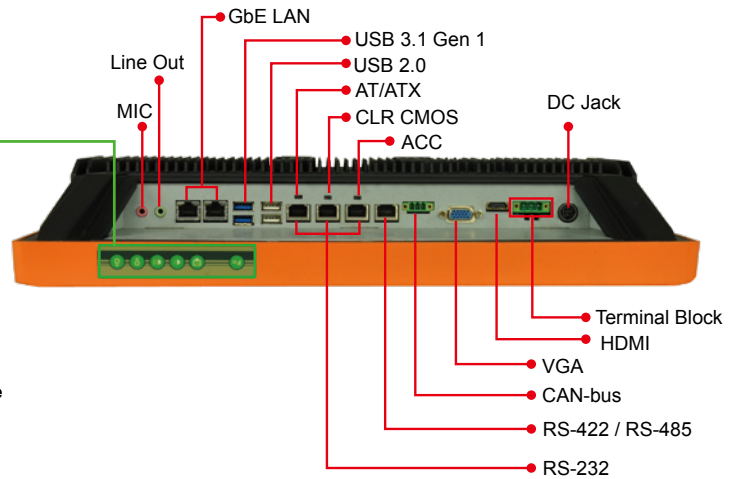

Dimensions (Unit: mm)

